

FT-1000

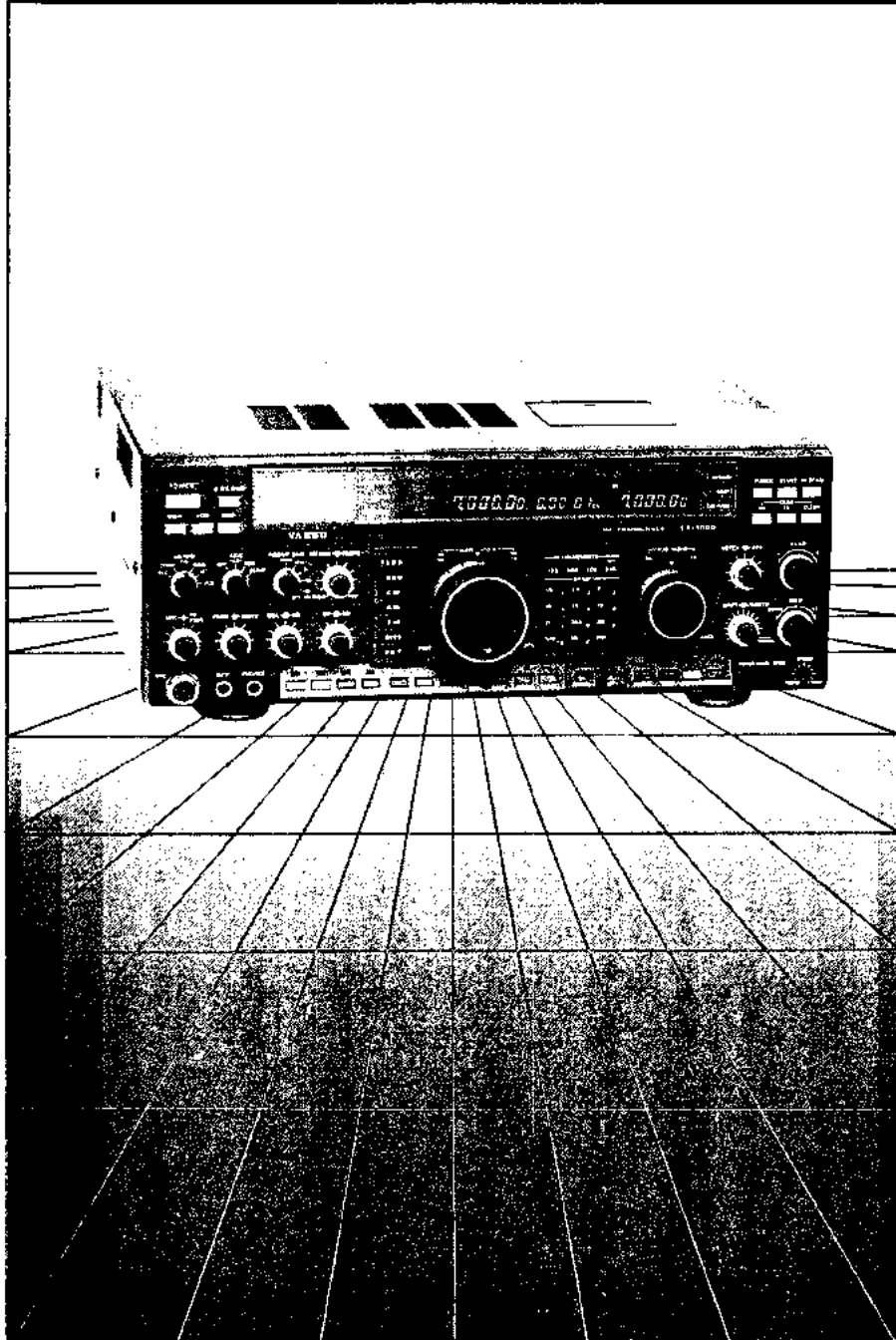

YAESU MUSEN CO., LTD.

CHOF. BOX 1500, TOKYO, JAPAN

YAESU U.S.A.

17210 Edwards Rd., Cerritos, California 90702, U.S.A.

YAESU EUROPE B.V.

Sigweg 3, 1118AA Schiphol, The Netherlands

Contents

1. Packaging	
2. Exploded View (Mechanical)	
Mechanical Parts List	2-4
3. Case Disassembly	
Circuit Board Access	3-2
4. Alignment	4-1
5. Modifications	5-1
6. Block Diagrams	
Local Unit Block Diagram	6-1
RX-2 Unit Block Diagram	6-2
Overall Block Diagram	6-3
7. PCB Diagrams & Parts Lists	
PCB Interconnection Diagram	7-1
RF Unit Parts List	7-2
RF Unit Layout	7-13
RF Unit Schematic Diagram	7-15
IF Unit Parts List	7-16
IF Unit Board Layout	7-28
IF Unit Schematic Diagram	7-30
AF Unit Parts List	7-31
AF Unit Board Layout	7-41
AF Unit Schematic Diagram	7-43
Local Unit Parts List	7-44
Local Unit Board Layout	7-54
Local Unit Schematic Diagram	7-56
Control Unit Parts List	7-57
Control Unit Board Layout	7-63
Control Unit Schematic Diagram	7-65
RX2 Unit Parts List	7-66
RX2 Unit Board Layout	7-80
RX2 Unit Schematic Diagram	7-82
PA Unit Parts List	7-83
PA Unit Board Layout	7-85
PA Unit Schematic Diagram	7-87
LPF Unit Parts List	7-88
LPF Unit Board Layout	7-90
LPF Unit Schematic Diagram	7-92
Protect Unit Parts List	7-93
Protect Unit Layout & Schematic	7-95
Tuner Main Unit Parts List	7-96
Tuner Main Unit Board Layout	7-98
Tuner Main Unit Schematic Diagram	7-100
Tuner Control Unit Parts List	7-101
Tuner Control Unit Board Layout	7-105
Tuner Control Unit Schematic Diagram	7-106
DDS A/B Unit Parts List	7-107
DDS A/B Unit Layout & Schematic	7-109
Width/Shift/Mode DDS Unit Parts List	7-110
Width/Shift/Mode DDS Unit Layout & Schematic Diagram	7-114
Reference (REF) Unit Parts List	7-115
Reference Unit Layout & Schematic	7-117
Display Unit Parts List	7-118
Display Unit Board Layout	7-120
Display Unit Schematic Diagram	7-121
PS Unit Parts List	7-122
PS Unit Board Layout	7-124
PS Unit Schematic Diagram	7-125
Rectifier (RECT) Unit Parts List	7-126
Rectifier (RECT) Schematic Diagram	7-128
Switch (SW) A Unit Parts List	7-129
Switch A Unit Layout & Schematic	7-131
Switch B & C Units Parts Lists	7-132
Switch B & C Units Layouts & Schematic Diagrams	7-134
Switch D, E & F Units Parts Lists	7-135
Switch D, E & F Units Layouts & Schematic Diagrams	7-137
Switch G, H & K Units Parts Lists	7-138
Switch G, H & K Units Layouts & Schematic Diagrams	7-140
VR A & B Units Parts Lists	7-141
VR A & B Units Layouts & Schematics	7-143
SHP Unit Parts List	7-144
SHP Unit Layout & Schematic	7-146
HP & Mic Units Parts Lists	7-147
HP & Mic Units Layouts & Schematics	7-149
XF-A & B Units Parts Lists	7-150
XF-A & B Units Layouts & Schematics	7-152
XF-C, D, E, F & G Units Parts Lists	7-153
XF-C, D, E, F & G Units Layouts & Schematic Diagrams	7-155
Key Ass'y A & B Parts Lists	7-156
Key Ass'y A & B Layouts & Schematic Diagrams	7-160
8. Options	
BPF-1 Packaging	8-1
BPF-1 Exploded View	8-2
BPF-1 Parts List	8-3
BPF-1 Board Layout	8-7
BPF-1 Schematic Diagram	8-8
BPF-1 Relay Unit Layout & Schematic	8-9
TCXO-1 Packaging	8-11
TCXO-1 Parts List	8-12
TCXO-1 Board Layout & Schematic	8-13

- OPERATING MANUAL FT-1000 E2710100
- YAESU WORLD HAM MAP B9000317
- STICKER "YAESU HAM RADIO" R8051900
- WARRANTY REGISTRATION CARD

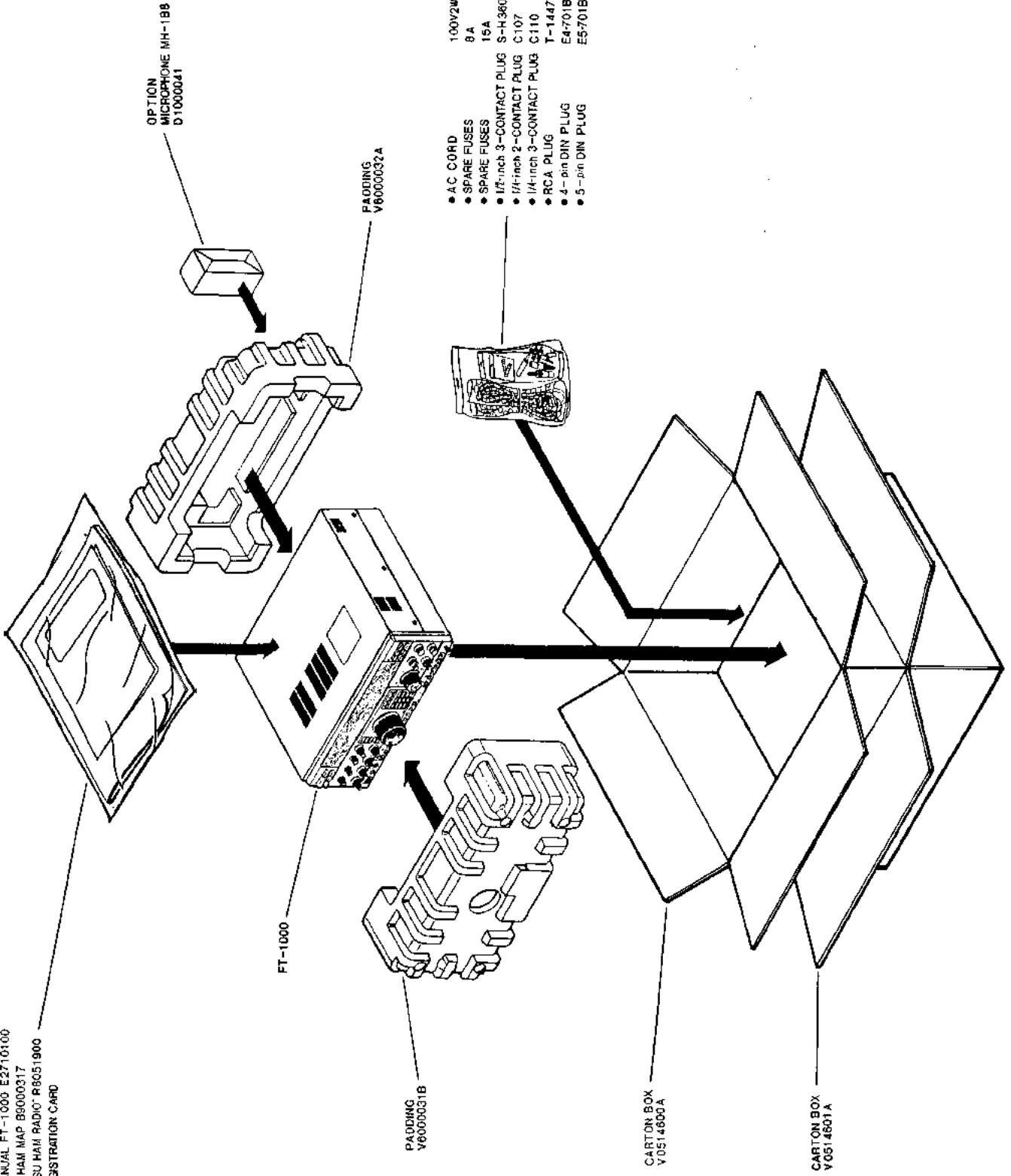

OPTION
MICROPHONE MH-1B8
D1000041

PADDING
V6000032A

FT-1000

PADDING
V6000031B

- AC CORD T 9017780
- SPARE FUSES 8A 00000039
- SPARE FUSES 15A 00000008
- 1/2-inch 3-CONTACT PLUG S-H3603 P 00900008
- 1/4-inch 2-CONTACT PLUG C107 P 00900034
- 1/4-inch 3-CONTACT PLUG C110 P 00900726
- RCA PLUG T-1447 P 0090544(2bca)
- 4-pin DIN PLUG E4701B-00 P 0090724
- 5-pin DIN PLUG E5701B-00 P 0090725

CARTON BOX
V0514600A

CARTON BOX
V0514601A

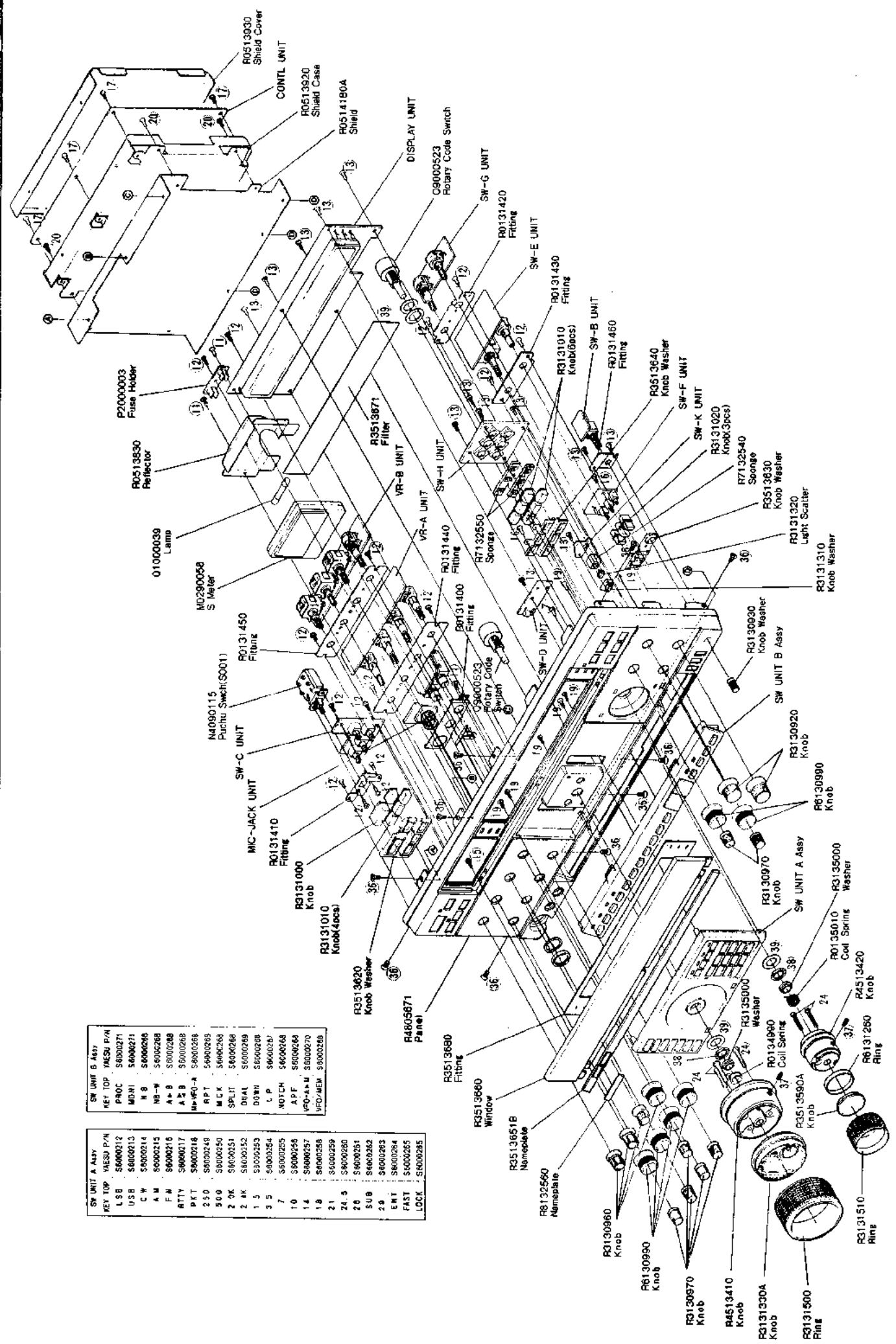

KEY TOP	WASU P/N
PROC	5800271
MDNI	5800271
MS	5800266
MB-W	5800268
A-B	5800268
MB-VO-A	5800268
RPT	5800265
MCK	5800268
SPLIT	5800268
DIAL	5800268
00WR	5800268
CP	5800267
NOTCH	5800268
APF	5800264
VO-A-M	5800270
WFO/HEM	5800268

KEY TOP	WASU P/N
LSB	5800212
USB	5800213
CW	5800214
AM	5800215
FM	5800216
RTTY	5800217
PKT	5800218
250	5800249
500	5800250
2 7K	5800251
2 4K	5800252
1 5	5800253
3 5	5800254
7	5800255
10	5800256
14	5800257
18	5800258
21	5800259
24.5	5800260
20	5800261
SUB	5800262
28	5800263
ENT	5800264
FAST	5800265
LOCK	5800265

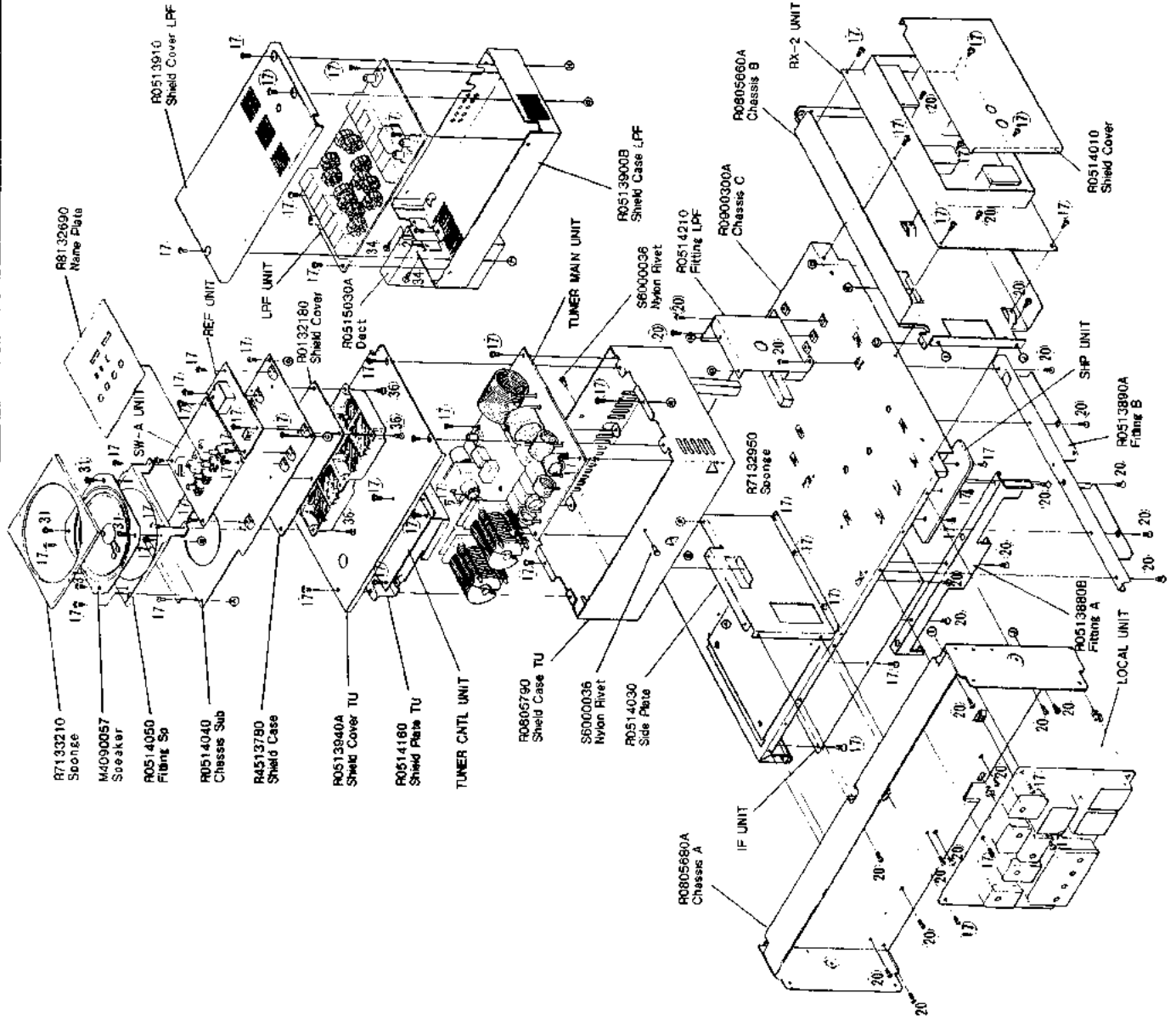

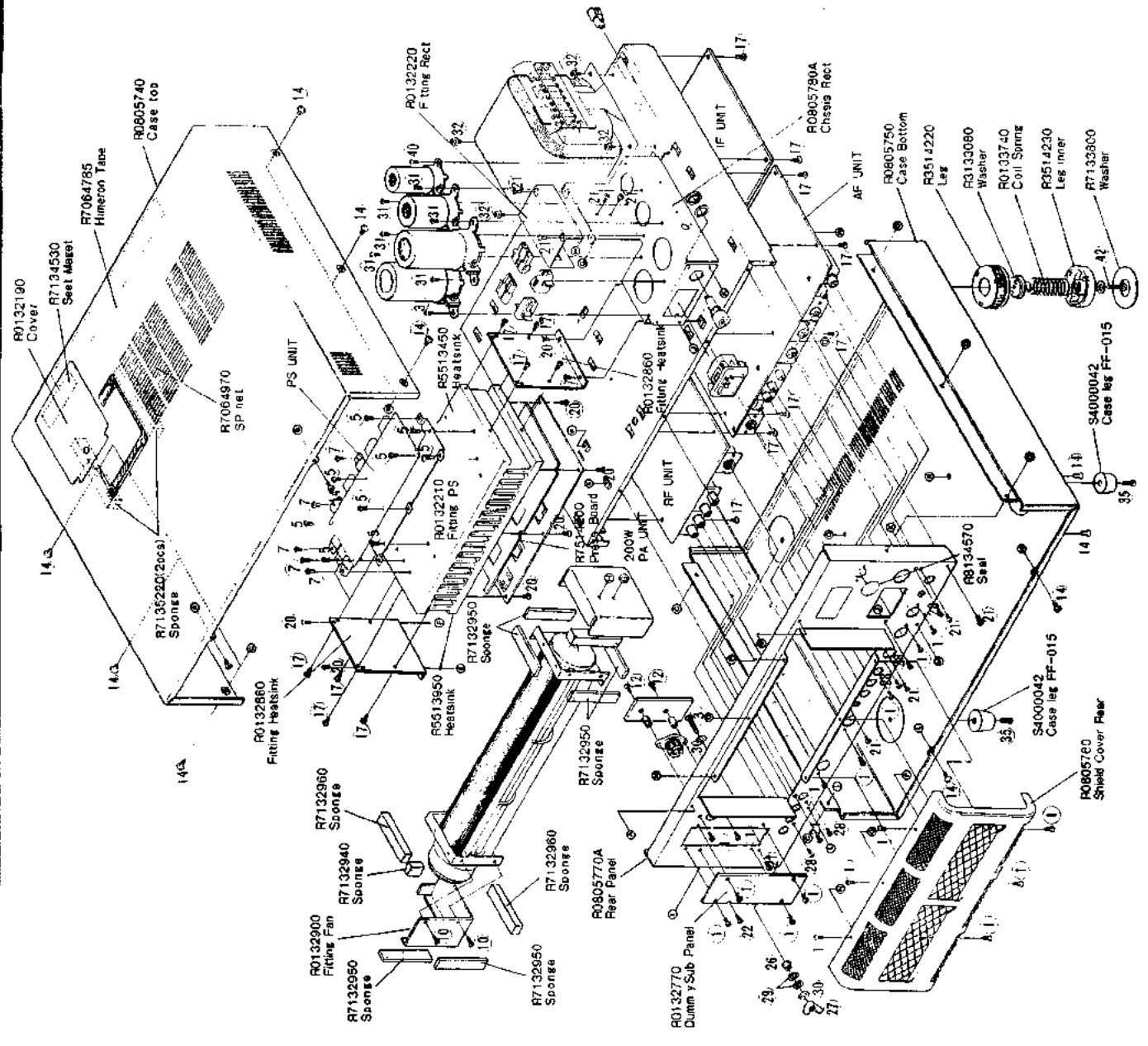

Mechanical Parts List

Ret No	Part No.	Description	Qty.
1	U00306007	M3X6B	17
2	U00312007	M3X12B	2
3	U00520002	M5X20 Ni	1
4	U02304001	SM3X4	4
5	U03306001	ASM3X6	4
6	U03308001	ASM3X8	13
7		not used	-
8		not used	-
9	U04306002	HSM3X6 Ni	6
10	U04406001	HSM4X6	2
11	U00204001	M2. 6X4	15
12	U20304001	BINDING HEAD SCREW M3X4	17
13		not used	-
14	U20406007	BINDING HEAD SCREW M4X6B	12
15	U23206001	TAPTITE SCREW M2. 6X6	1
16	U24204001	TAPTITE SCREW M2. 6X4	9
17	U24306001	TAPTITE SCREW M3X6	81
18	U24316001	TAPTITE SCREW M3X16	1
19	U23208001	TAPTITE SCREW M2. 6X8	9
20	U44305001	TAPTITE SCREW M3X5	46
21	U44305007	TAPTITE SCREW M3X5B	11
22	U43305001	TAPTITE SCREW M3X5	2
23	U44306001	TAPTITE SCREW M3X6	2
24	U43308001	TAPTITE SCREW M3X8	5
25	U66300001	FLANGE NUT N3	2
26	U66500002	FLANGE NUT N5 Ni	1
27	U65500102	WING NUT N5 Ni	1
28	U44306007	TAPTITE SCREW M3X6B	5
29	U70005002	FW5 Ni	2
30	U73005002	IW5 Ni	2
31	U9900010	TAPTITE SCREW HM3X6B	7
32	U9900009	HEX HEAD BOLT HSM5X8	4
33	Q6000114	B-4	2
34	U40304201	FLAT HEAD SCREW 3X4	2
35	U20410007	BINDING HEAD SCREW M4X10B	2
36	U30306001	TAPPING SCREW M3X6	10
37	U91406020	HEX SOCKET SET SCREW M4X0.7X6	2
38	U62012001	VOLUME NUT 12X14X2(P1)	2
39	U70012001	FW 12	4
40	U24308001	TAPTITE SCREW M3X8	1
41	U9900021	TAPTITE SCREW HM3X6	1
42	U22416007	BINDING HEAD SCREW HM4X16B	2
43	U44408001	TAPTITE SCREW M4X8	3
44	U44406001	TAPTITE SCREW M4X6	3
45	U24310001	BINDING HEAD SCREW M3X10	4
46	U46308201	TAPPING SCREW 3X8	4

Notes

Case Disassembly

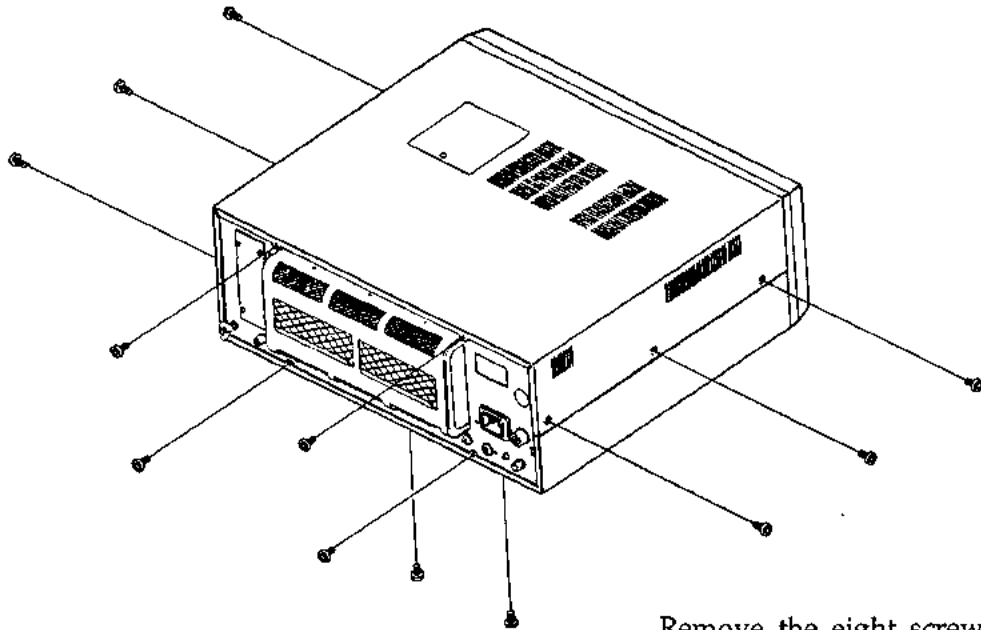

Remove the eight screws in the top cover first, and remove the top cover. Then place the set on its side or upside-down, and remove the remaining 4 screws to remove the bottom cover.

Top & Bottom Cover Removal

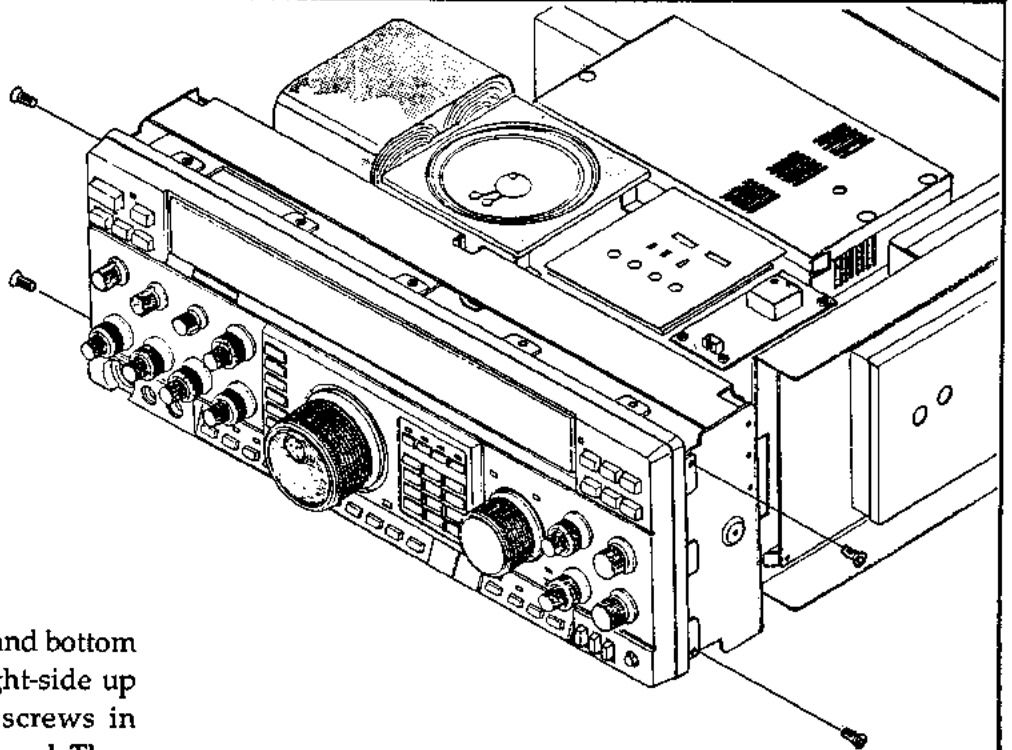

After removing the top and bottom covers, place the set right-side up and remove the two screws in either side of the front panel. Then pull the panel forward slightly before folding it down.

Front Panel Removal

Circuit Board Access

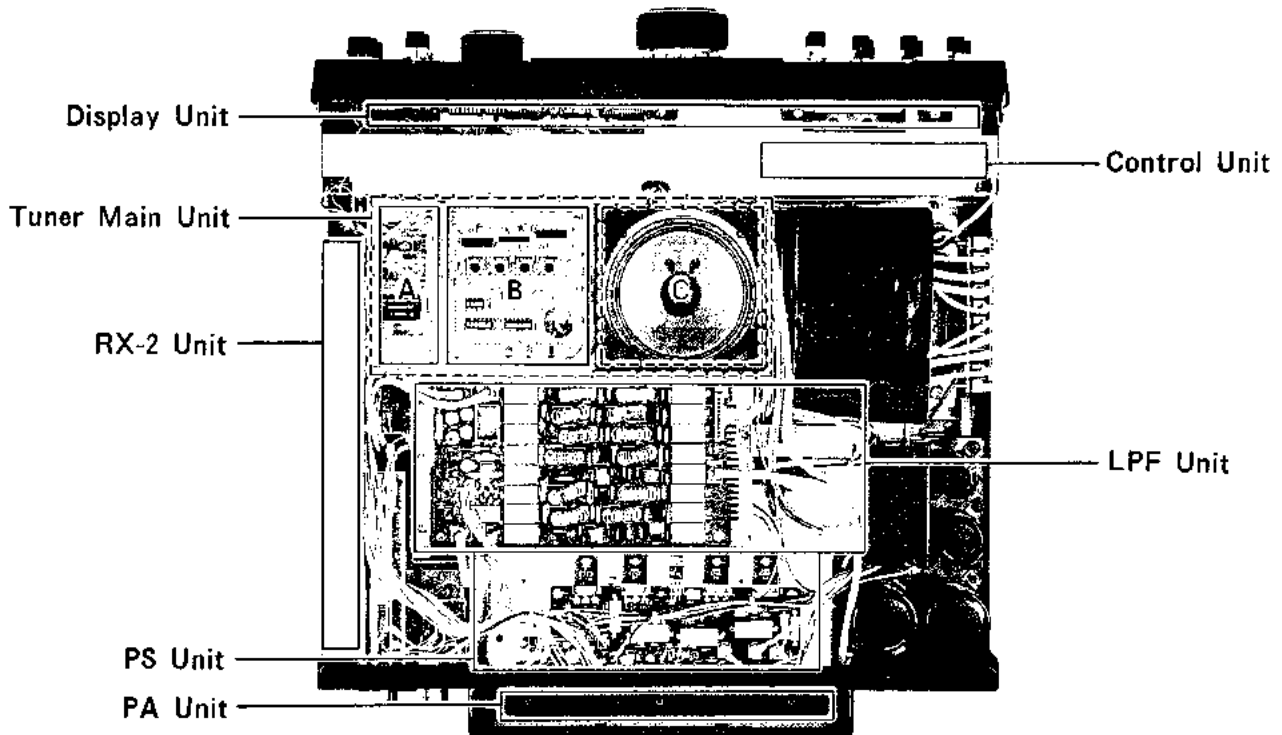

For Service Manuals Contact
MAURITRON TECHNICAL SERVICES
 8 Cherry Tree Rd, Chinnor
 Oxon OX9 4QY
 Tel:- 01844-351894 Fax:- 01844-352554
 Email:- enquiries@mauritron.co.uk

A: TCXO-1 Unit
 B: SW-A Unit
 C: Tuner Control Unit

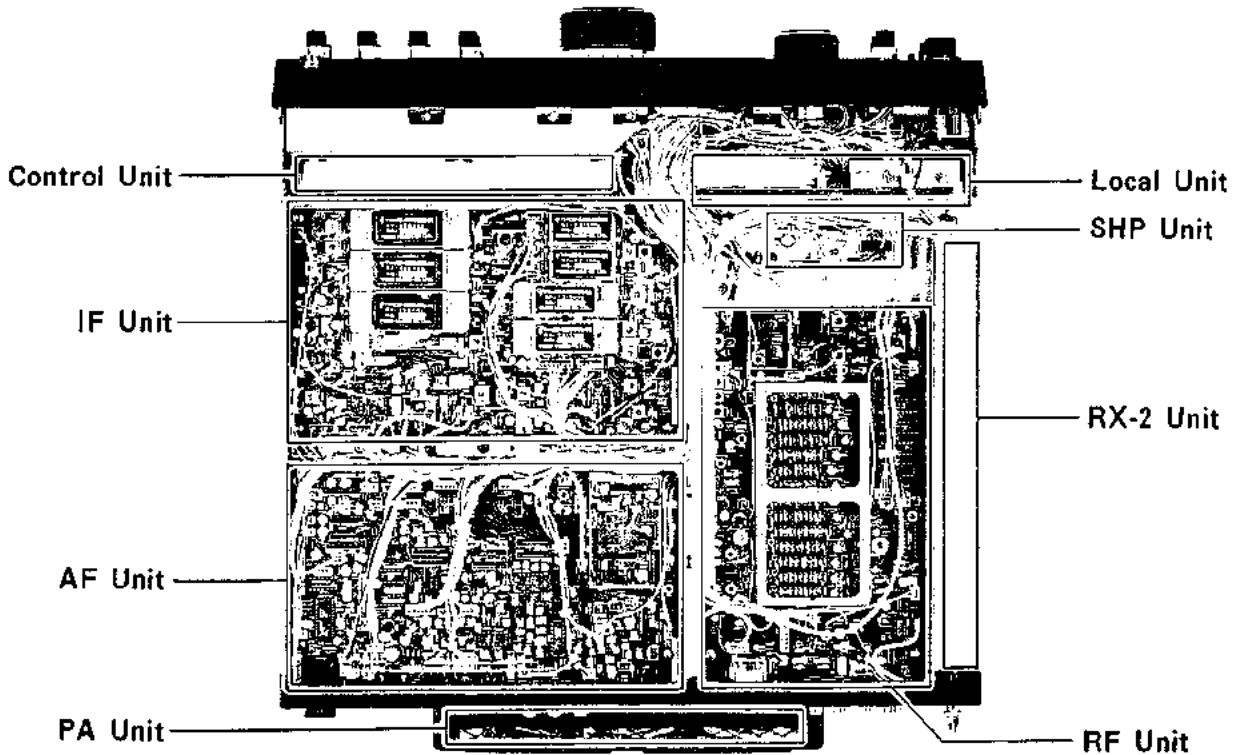

Alignment

The FT-1000 is carefully designed to allow the knowledgeable operator to make nearly all adjustments required for various station conditions, modes and operator preferences simply from the controls on the panels, without opening the case of the transceiver. These adjustments, plus certain internal settings, are described in the FT-1000 Operating Manual.

The following procedures cover the sometimes critical and tedious adjustments that are not normally required once the transceiver has left the factory. However, if damage occurs and some parts subsequently be replaced, realignment may be required. If a sudden problem occurs during normal operation, it is likely due to component failure; realignment should not be done until after the faulty component has been replaced.

We recommend that servicing be performed only by authorized Yaesu service technicians who are experienced with the circuitry and fully equipped for repair and alignment. Therefore, if a fault is suspected, contact the dealer from whom the transceiver was purchased for instructions regarding repair. Authorized Yaesu service technicians realign all circuits and make complete performance checks to ensure compliance with factory specifications after replacing any faulty components.

Those who do undertake any of the following alignments are cautioned to proceed at their own risk. Problems caused by unauthorized attempts at realignment are not covered by the warranty policy. Also, Yaesu must reserve the right to change circuits and alignment procedures in the interest of improved performance, without notifying owners.

Under no circumstances should any alignment be attempted unless the normal function and operation of the transceiver are clearly understood, the cause of the malfunction has been clearly pinpointed and any faulty components replaced, and the need for realignment determined to be absolutely necessary.

The following test equipment (and thorough familiarity with its correct use) is necessary for complete realignment. Correction of problems caused by misalignment resulting from use of improper test equipment is not covered under the warranty policy. While most steps do not require all of the equipment listed, the interactions of some adjustments may require that more complex adjustments be performed afterwards. Do not attempt to perform only a single step unless it is clearly isolated electrically from all other steps.

Rather, have all test equipment ready before beginning, and follow all of the steps in a section in the order they are presented.

- DC Voltmeter (high-Z, >1-M Ω /V)
- RF Millivoltmeter
- AF Millivoltmeter
- RF Standard Signal Generator w/calibrated output and dB scale, 0dB=0.5 μ V
- AF Signal Generator with calibrated output
- Spectrum Analyzer (30 MHz)
- 50- Ω Dummy Load
- 50- Ω Resistor ($\frac{1}{4}$ - or $\frac{1}{2}$ -W, film or composition)
- 600- Ω Resistor ($\frac{1}{4}$ - or $\frac{1}{2}$ -watt)
- 16.6- Ω Dummy Load (or 3 50- Ω loads that can be connected in parallel)
- Adjustable, Regulated DC Supply (0 - 5 V)
- Linear Detector
- RF Attenuator (200-W, 40-dB) or RF coupler

Alignment Preparation & Precautions

A 50- Ω dummy load and inline wattmeter must be connected to the main antenna jack in all procedures that call for transmission, except where specified otherwise. Correct alignment is not possible with an antenna.

Except where specified otherwise, the transceiver should be tuned to 14.2 MHz, USB mode, and the following controls set as indicated:

- MOX & VOX** buttons OFF (■)
- AGC** to **FAST**
- ATT** to **OFF**
- RX MIX & MONI** to 12-o'clock
- MIC & RF PWR** fully CCW (minimum)
- PROC & DRIVE** fully CCW (minimum)
- SQL** fully CCW, **NB** 12-o'clock
- AF** as required, **RF** fully CW (maximum)
- NOTCH & APF** to 12-o'clock
- SHIFT** to 12 o'clock, **WIDTH** fully CW

After completing one step, read the following step to determine whether the same test equipment will be required. If not, remove the test equipment (except dummy load and wattmeter, if connected) before proceeding.

Correct alignment requires that the ambient temperature be the same as that of the transceiver and test equipment, and that this temperature be

held constant between 20 and 30 °C (68 ~ 86 °F). When the transceiver is brought into the shop from hot or cold air it should be allowed some time for thermal equalization with the environment before alignment.

Alignments must only be made with oscillator shields and circuit boards firmly affixed in place. Also, the test equipment must be thoroughly warmed up before beginning.

Note: Signal levels in dB referred to in the alignment procedure are based on 0 dBμ = 0.5 dBμV.

Table note: DC voltages should measure within ±10% of those listed in the voltage tables.

Local Unit

Reference Amp

- Remove coaxial TMP plug P7702 from connector J4015 and connect the 50-Ω resistor across the socket. Connect the RF millivoltmeter across the resistor, and adjust T4002 for 140 mV_{rms}. Remove the resistor and meter, and replace P7702 in J4015.

- Connect the RF millivoltmeter to TP4001 and adjust T4003 for 450 mV_{rms}.

Reference Multiplexer BPFs

Connect the RF millivoltmeter to TP4003. Adjust T4004, T4005 and T4006 for peak, in that order. Final voltage should be at least 500 mV_{rms}.

8.67-MHz 3rd Local Oscillator Frequency

Make sure the WIDTH control is fully clockwise, and connect the frequency counter across J4005. Adjust TC4001 for 8.67000 MHz ± 50 Hz.

52.64488 MHz Oscillator Frequency

- Preset TC4006 and TC4007 to their center positions, select the LSB mode, and connect the frequency counter to TP4005.
- Adjust L4071 for 52.64488 MHz ± 50 Hz on the counter.
- Now switch to USB mode and adjust TC4006 for the same frequency (TC4007 remains preset to center).

65.405 MHz (2nd LO) VCXO Control Voltage

- Select the AM mode, connect the DC voltmeter to TP4002, and adjust L4069 for 2.5 ± 0.2 V.

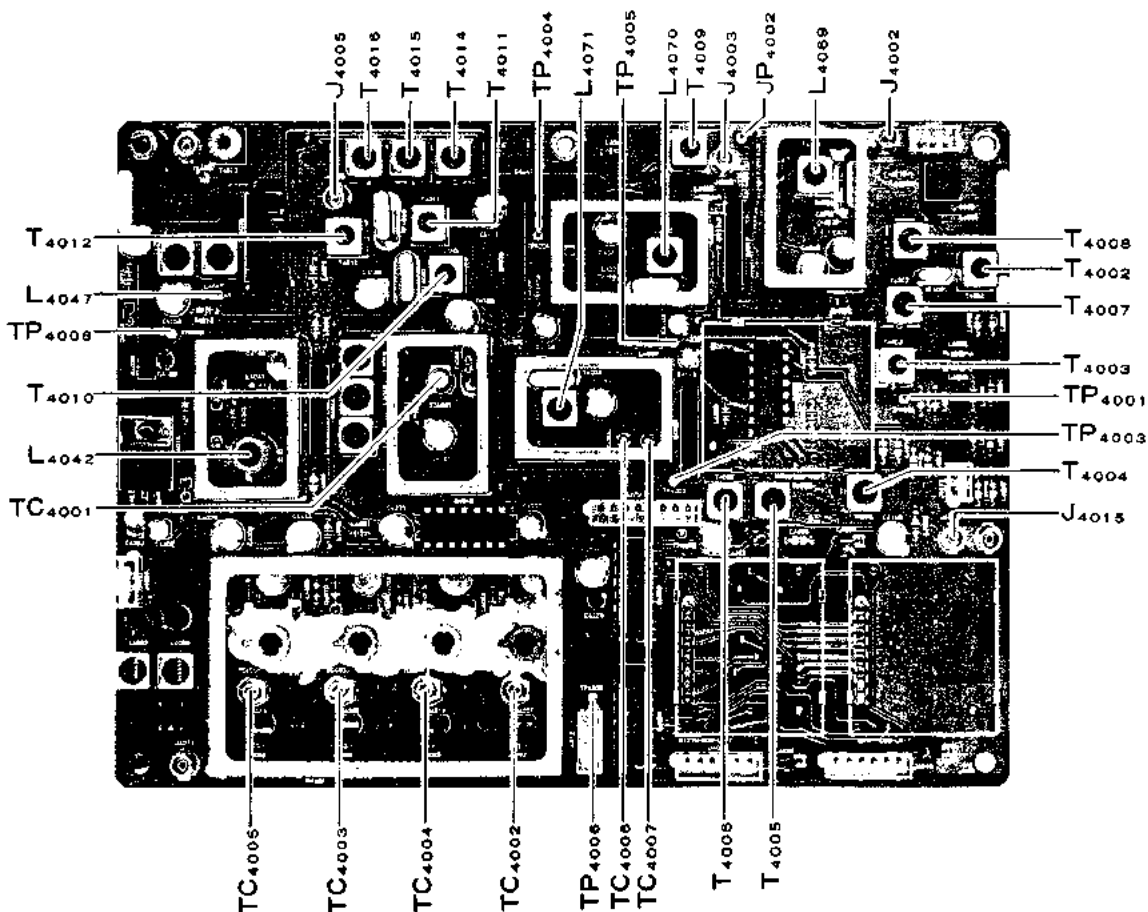

Local Unit Test & Alignment Points

- Now select the RTTY (LSB) mode and confirm 3.2 ± 0.4 V at TP4002.
- Press the RTTY button again to switch to RTTY (USB) and confirm 1.6 ± 0.4 V.

2nd Local Output Level

Select the AM mode, unplug the connector from J4002, and connect the RF millivoltmeter and 50-Ω resistor in its place. Adjust T4007 and T4008 for at least $240 \text{ mV}_{\text{rms}}$.

52.77 MHz VCXO Control Voltage

Set the **WIDTH** and **SHIFT** controls both fully counterclockwise. Connect the DC voltmeter to TP4004, and adjust L4070 for 1.5 ± 0.2 V. Now turn the **WIDTH** and **SHIFT** controls fully CW, and confirm 4.2 ± 0.2 V.

3rd Local Output Level

Set the **WIDTH** control to the 12-o'clock position, unplug the connector from J4005, and connect the RF millivoltmeter and 50-Ω resistor in its place. Adjust T4010 ~ T4012 for at least $300 \text{ mV}_{\text{rms}}$ on the meter.

4th Local Output Level

Select the AM mode, set the **WIDTH** control fully clockwise and the **SHIFT** control to 12 o'clock. Unplug the connector from J4003, and connect the RF millivoltmeter and 50-Ω resistor in its place. Adjust T4009 for at least $140 \text{ mV}_{\text{rms}}$.

61.44 MHz BPF

With the AM mode selected, set the **WIDTH** and **SHIFT** controls to 12-o'clock, and connect the frequency counter to L4047 (see photo below). Adjust L4042 for 62.1 ± 0.1 MHz.

Connect the RF millivoltmeter to TP4007 and adjust T4014 ~ T4016 for at least $1.0 \text{ V}_{\text{rms}}$.

Counter Connection for 61.44 MHz BPF

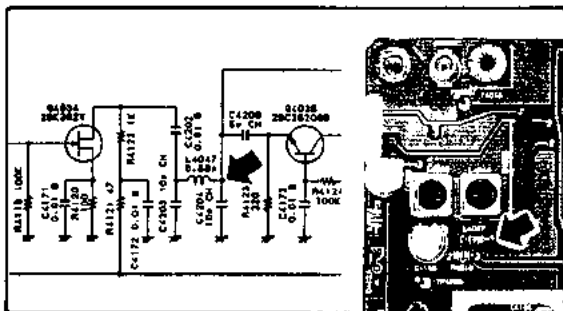

Sub-Loop VCO VCV

Select the LSB mode, and connect the DC voltmeter to TP4008. Tune the display to 655.35 kHz

and adjust L4042 for 4.0 ± 0.2 V. Turn the tuning dial to 655.36 kHz, and confirm 1.7 ± 0.5 V.

Main VCO VCV

- With the LSB mode selected, connect the DC voltmeter to TP4006. Tune the display to 30.000 MHz, and adjust TC4005 for 10.0 ± 0.2 V. Retune the display to 22.000 MHz, and confirm 4.1 ± 0.5 V.
- Tune the display to 21.999 MHz and adjust TC4004 for 10.0 ± 0.2 V. Retune to 14.500 MHz, and confirm 4.0 ± 0.5 V.
- Tune the display to 14.499 MHz and adjust TC4003 for 10.0 ± 0.2 V. Retune the display to 7.500 MHz, and confirm 4.4 ± 0.5 V.
- Tune the display to 7.499 MHz and adjust TC4002 for 10.0 ± 0.2 V. Retune the display to 100 kHz, and confirm 4.5 ± 0.5 V.

RX-2 Unit

With the power off, preset the **SQL**, **MONI**, **RX MIX** and **AF** controls on the front panel all fully CCW, and set the **FRONT END** selector to the **IPO** position. Refer to the diagram on the next page for alignment point locations.

RX-2 Carrier Frequency

Connect the frequency counter to TP6003. Referring to the table below, press the **SUB** button followed by the indicated mode button to set the sub receiver mode, and adjust the corresponding trimmer for the listed frequency ± 50 Hz.

SUB + LSB	TC6001	8.1365 MHz
SUB + USB	TC6002	8.1335 MHz
SUB + CW (Narrow)	TC6003	8.1352 MHz
SUB + AM	TC6004	8.1350 MHz

Replace the counter at TP6003 with the RF millivoltmeter, and adjust T6021 for $200 \pm 50 \text{ mV}_{\text{rms}}$.

10.48576 MHz Reference Level

Connect the RF millivoltmeter to TP6011 and adjust T6029 for $225 \pm 75 \text{ mV}_{\text{rms}}$.

PLL-1 7.68 MHz Loop VCV

Connect the DC voltmeter to TP6007 and adjust TC6005 for 5 ± 0.2 V.

PLL-2 40.96 MHz Loop VCV

- Connect the DC voltmeter to TP6006 and adjust L6019 for 5 ± 0.2 V.

- Connect the RF millivoltmeter to pin 2 of J6005 and adjust T6027 for 130 ± 30 mV_{rms}.

2nd Local Level

Connect the RF millivoltmeter to TP6002 and adjust T6030 ~ T6032 for at least 400 mV_{rms}.

10-Hz Digit 46-MHz Local BPF

- Connect the frequency counter to TP6008 and adjust L6029 for approximately 47 MHz.
- Connect the RF millivoltmeter to TP6009 and adjust T6023 ~ T6026 for peak voltage (at least 1.2 V_{rms}).

10-Hz Digit VCO VCV

Select the LSB mode, and tune to 655.36 MHz. Connect the DC voltmeter to TP6005 and adjust L6029 for 1 to 1.2 V. Now retune to 655.35 MHz and confirm 3.5 ± 0.3 V.

Main Loop VCV

- Tune the transceiver to 30.00000 MHz and connect the DC voltmeter to TP6010. Adjust TC6009 for 10 ± 0.2 V. Retune to 22.00000 MHz and confirm 3.4 ± 0.5 V.
- Retune to 21.99999 MHz and adjust TC6008 for 10 ± 0.2 V. Retune to 14.50000 MHz and confirm 3.0 ± 0.5 V.

- Retune to 14.49999 MHz and adjust TC6007 for 10 ± 0.2 V. Retune to 7.50000 MHz and confirm 4.0 ± 0.5 V.

- Retune to 7.49999 MHz and adjust TC6006 for 10 ± 0.2 V. Retune to 100 kHz and confirm 3.3 ± 0.5 V.

Sub Receiver Sensitivity

- Connect the AF millivoltmeter to the **EXT SP** jack and the RF signal generator (set for 0 dB output) to the BPF-1 **ANT** jack, if installed, or else to the main **ANT** jack on the rear panel.
- Select the CW mode (**SUB + CW**), and tune the transceiver and signal generator for an 1-kHz heterodyne near 14.11 MHz in the sub receiver. Set the **AGC** selector to **OFF**.

- Adjust T6004 ~ T6006, T6008 ~ T6011 and T6013 ~ T6017 for peak indication on the AF millivoltmeter.

Sub Receiver Squelch Threshold

- With the same setup as in the Sub Receiver Sensitivity procedure above, reduce the signal generator output to nil, select the USB mode (**SUB + USB**), and set the **SQL** control to the 10-o'clock position.
- Adjust VR6006 so that the squelch just closes. Now select the FM mode (**SUB + FM**), move the

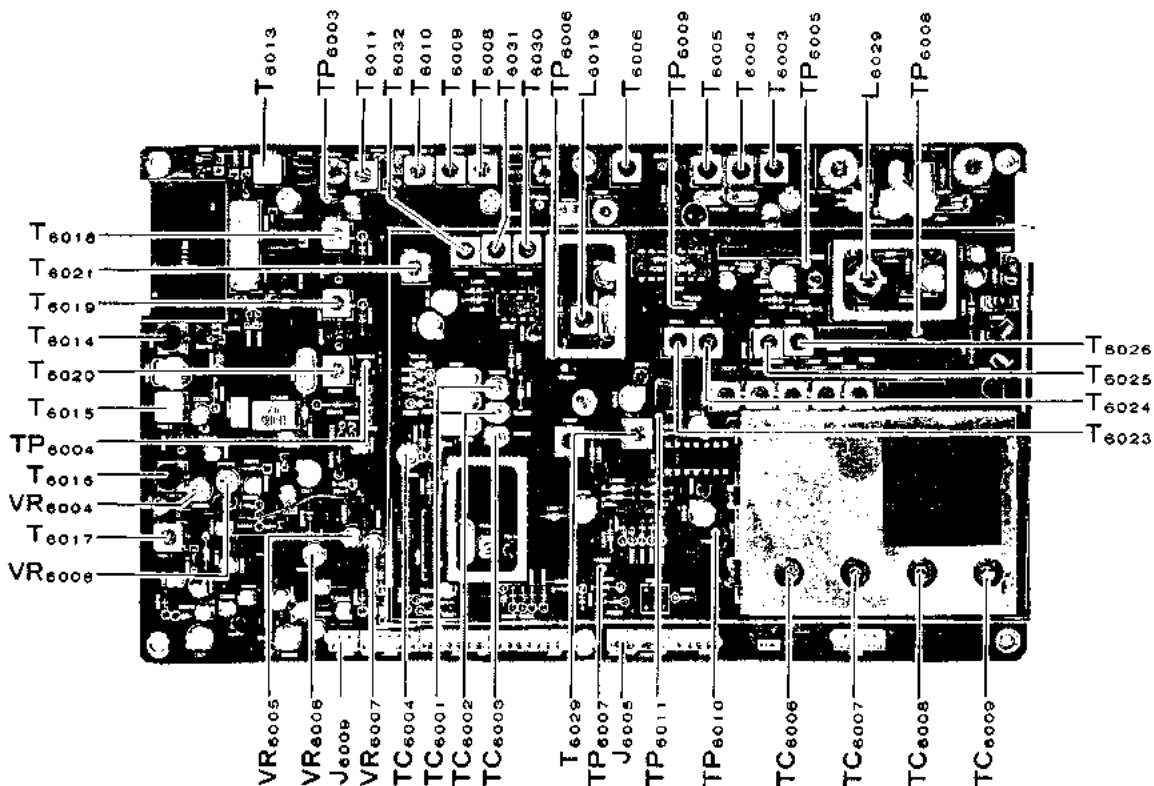

RX-2 Unit Test & Alignment Points

SQL control to the 9-o'clock position, and adjust VR6008 so that the squelch again just closes.

Keep the AF millivoltmeter and signal generator connected for the next procedure.

Sub Receiver S-Meter Calibration

Use the same AF millivoltmeter and signal generator setup as in the last two procedures.

- Connect the temporary meter test circuit as shown below to pin 2 of J6009 and the board ground.
- With no RF injection, adjust VR6005 so the S-meter just begins to deflect above 0.
- Inject 8 dB from the signal generator, and adjust VR6004 for precise S-1 indication.
- Increase RF injection to 12 dB, and adjust VR6005 *again* for precise S-1 indication.
- Increase injection to 100 dB, and adjust VR6007 for S-9 +60 dB (full scale) S-meter deflection.

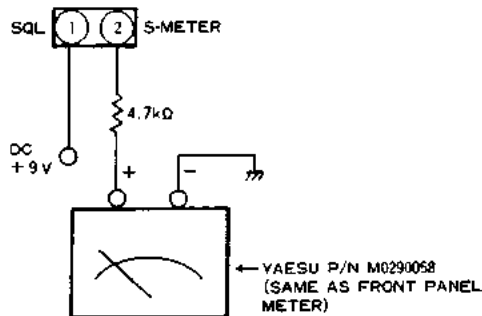

S-Meter Alignment Jig

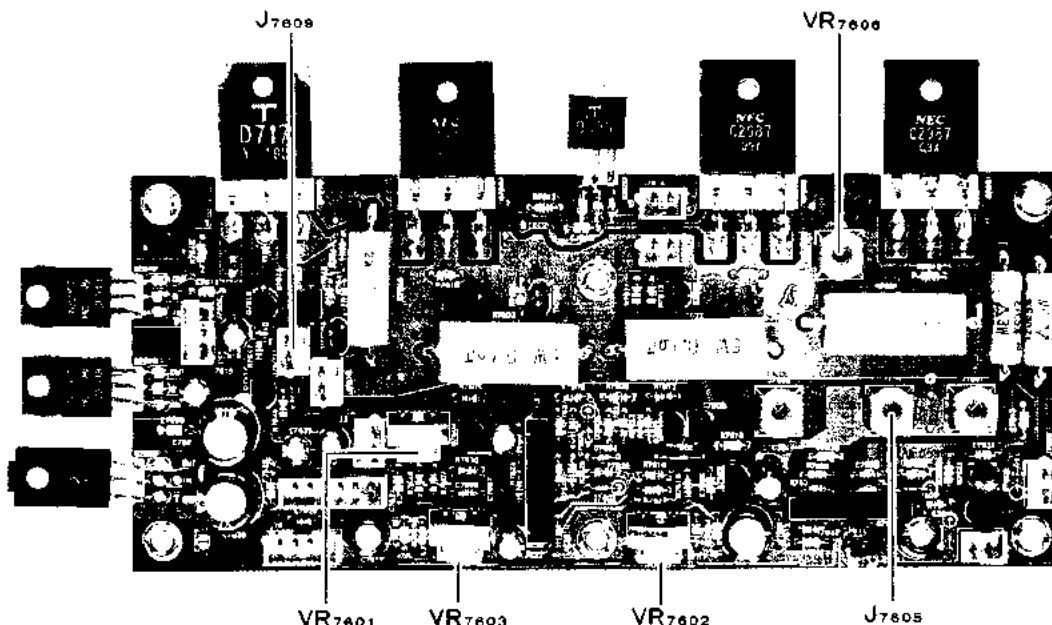

PS (Power Supply) Unit Test & Alignment Points

Sub Receiver Noise Blanker Level

With the USB mode selected, connect the DC voltmeter to TP6004, and increase the 14.11-MHz RF injection at the ANT jack to 10 dBμ. Adjust T6018 ~ T6020 for *minimum* DC on the meter.

Sub Receiver Noise Blanker Check

- Using a 1-ms noise pulse width and 100-ms interval, with both NB and NB-W off, set the pulse amplitude for S-7 deflection on the S-meter. Pressing NB should cause the S-meter deflection to drop to S-1.
- Using a 10-ms noise pulse width and 100-ms interval, with both NB and NB-W off, set the pulse amplitude for S-7 deflection on the S-meter. Pressing NB-W should cause the S-meter deflection to drop to S-1.

PS Unit (Power Supply)

30-V Regulator

Remove the plugs from J7605 (+30 V) and J7606 (ground), and connect the DC voltmeter to these jacks. Adjust VR7602 for 31.5 +0/-0.3 V, and replace the wires in J7605 and J7606.

13.5-V Regulator

Remove the plug from J7609, and connect the DC voltmeter between the socket pins (pin 2 is positive). Adjust VR7603 for 13.5 ± 0.3 V.

Overcurrent Protection

Caution! This procedure necessitates transmitting at a power level beyond specifications. Do not key the transmitter for more than a few seconds at a time.

- Remove the plug from J7605, and connect the ammeter in series with J7605 and the plug removed from it above (not to ground!!). Make sure the meter connections are solid enough to handle 30 Amperes, or use a clip-around meter clipped around the cable — in this case plugged into J7605.
- Tune the transceiver to the 7-MHz band, CW mode, and connect the 50-Ω Dummy Load to the main ANT jack.
- On the AF Unit, mark the precise position of RF power trimmer VR3016 (see photo below), then turn it fully clockwise (maximum), and set the RF PWR control on the front panel to 12 o'clock.

VR3016 Location on AF Unit

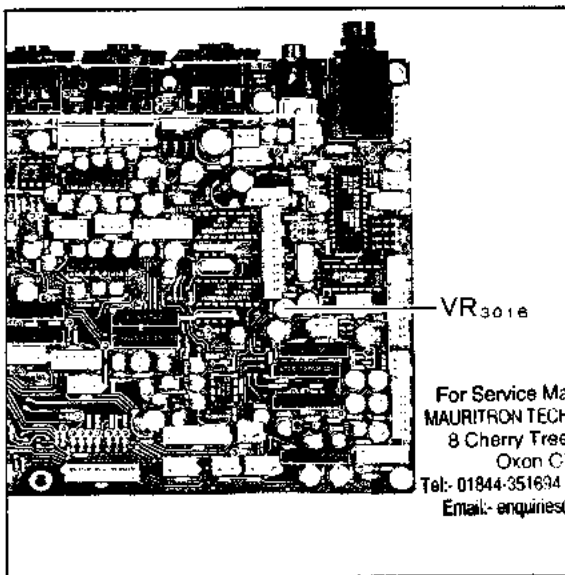

- Briefly key the transmitter and adjust the RF PWR control clockwise so that the ammeter shows 23 amperes, then return to receive.
- Place your tuning tool in VR7601, key the transmitter again, and adjust VR7601 so that the supply just shuts down (the current drops from 23 amperes to zero).
- Return VR3016 to its original position, and remove the test equipment and replace the plug in J7605, if necessary.

PA Unit (RF Power Amplifier)

Select the SSB mode, and disconnect the microphone or turn the MIC gain fully CCW.

Driver Idling Current

Connect the DC voltmeter across R7014. Depress the MOX button and adjust VR7001 for 40 ± 10 mV.

Final Idling Current

Connect the DC voltmeter across R7027. Depress the MOX button and adjust VR7002 for 6 ± 1 mV.

LPF Unit

CM Coupler Balance

With the 50-Ω dummy load connected to the ANT jack, tune the transceiver to 14 MHz, and select the CW mode. Connect the negative lead of the DC voltmeter to pin 3 of J7023, and the positive lead to ground. Key the transmitter and adjust TC7201 for *minimum* on the voltmeter.

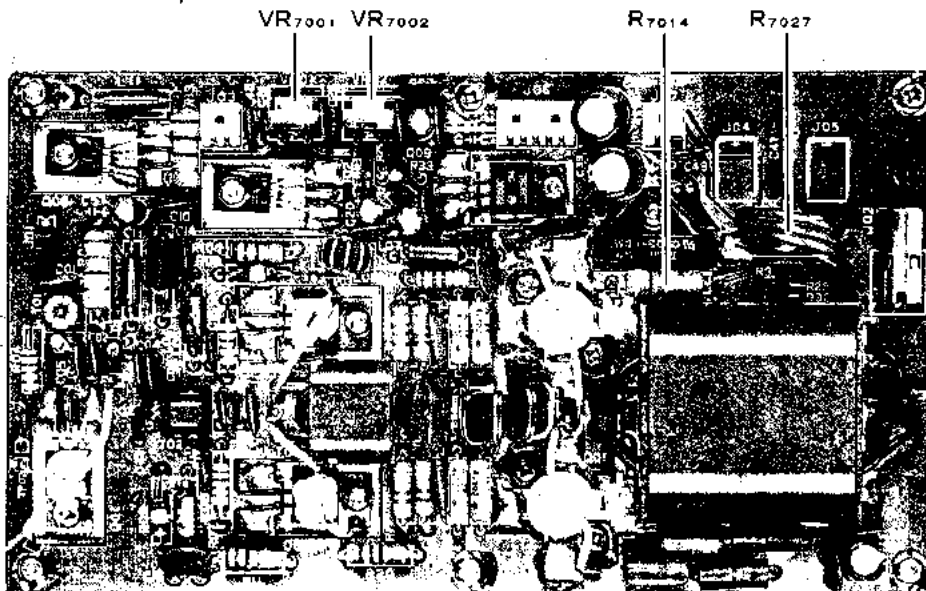

PA (RF Power Amp) Unit Test & Alignment Points

LPF Unit Test & Alignment Points

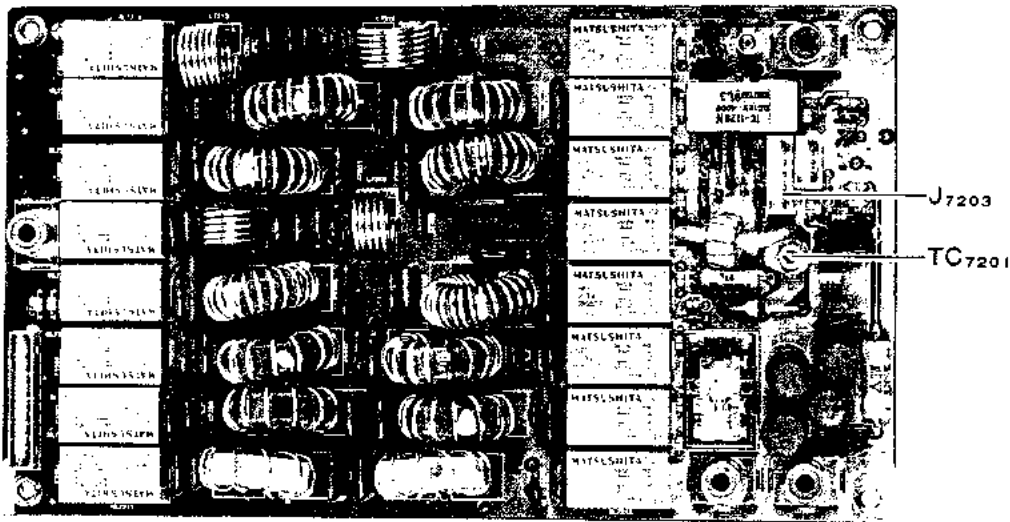

Tuner Unit

On the front panel, set the **METER** selector to **SWR**, and the **DRIVE** and **RF PWR** controls fully CW. Preset S7501 to OFF, VR7501 fully CCW, VR7502 fully CW, and TC7401 (on the Tuner Main Unit) to center.

Tuning Capacitor/Motor

(Mechanical Check, Setting & Adjustment)

- Loosen all setscrews in the shaft coupler, and turn the coupler by hand to confirm it moves freely (the motor and capacitor should not move). If the coupler binds, check the motor mounting position (it is soldered in place) and the capacitor mounting (screws).

- Turn the power switch off, and jump TP7501 to chassis ground.
- Turn the power switch on - the motor should rotate, and then stop.
- Set the capacitor to its maximum capacitance position (plates fully meshed) by hand, and tighten all shaft coupler setscrews, using care not to disturb the capacitor or motor positions. Turn the power off, and jumper TP7502 to chassis ground (along with TP7501). Turn the power back on. The motor should move 180°, and the capacitor should be then at its minimum capacitance position (fully unmeshed). Remove the grounding jumpers from TP7501 and TP7502.

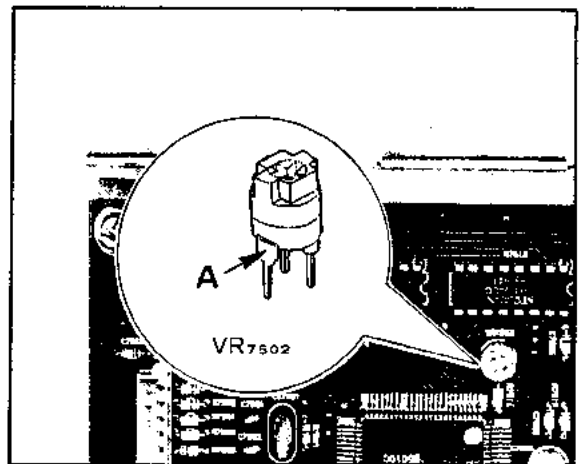
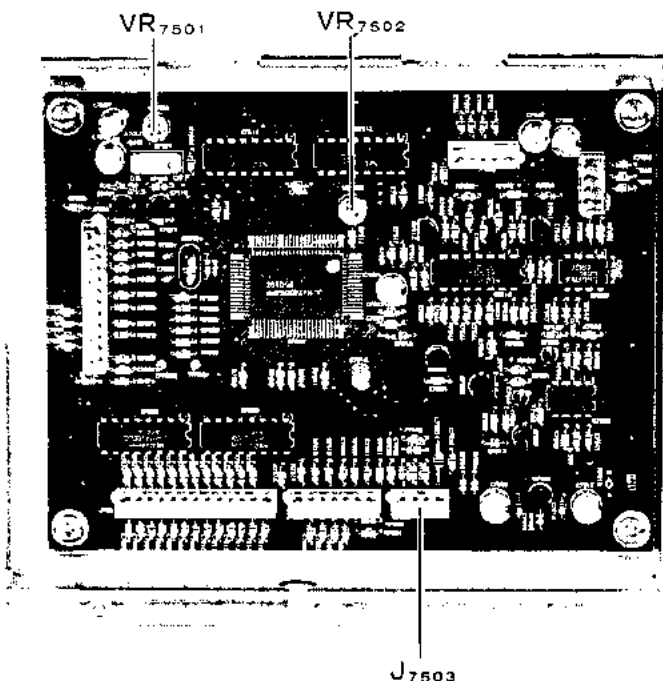

J7503
Tuner Control Unit Test & Alignment Points

SWR Meter Calibration

With the **METER** selector set to the **SWR** position, the antenna tuner OFF, and no connection to the **ANT** jack, tune the transceiver to 1.5 MHz, CW mode. Press the **MOX** button and adjust VR7501 for full scale meter deflection.

Tuner SWR Auto Start Level

Connect the DC voltmeter to the wiper (center) contact of VR7502 (see photo) and adjust this potentiometer for 1.7 ± 0.1 V on the voltmeter.

TC7401 Location on Tuner Main Unit

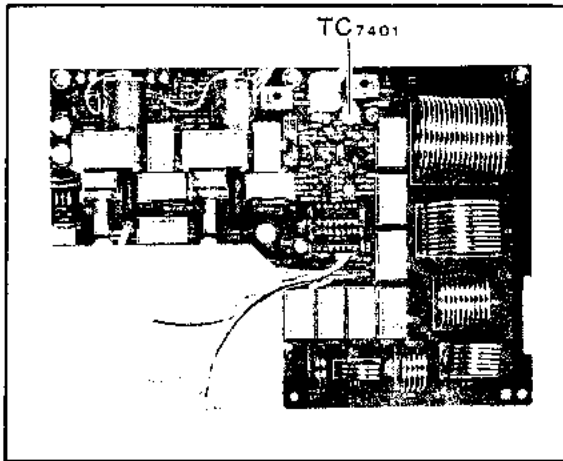

Tuner Impedance

Connect the 50-Ω dummy load and wattmeter to the main **ANT** jack, tune the transceiver to 3.5 MHz, CW mode. Press the **START** button and confirm that the **TUNER** LED comes on, the

transmitter is activated, and the **WAIT** LED is lit. Then press the **MOX** button and confirm that the S-meter shows an SWR of 1.1 or better. If not, adjust TC7401 (on the Tuner Main Unit - see above) so that it does, and press **START** again. Repeat until the meter reads correctly (the voltage at pin 2 of J7503 should switch from 0 to 5 V when the SWR is below 1.1:1).

IF Unit

Notch Filter Oscillator

- With the **NOTCH** button OFF and the **NOTCH** control centered, preset TC2001 to center. Connect the DC voltmeter to pin 2 of J2019 and confirm 3.8 ± 0.2 V on the voltmeter.
- Select the LSB mode, and connect the frequency counter to TP2003. Adjust T2027 for 12.2835 MHz on the counter (if this frequency cannot be obtained, adjust TC2001). Now select the USB mode, and adjust TC2002, if necessary, for $12.2805 \text{ MHz} \pm 30 \text{ Hz}$ on the counter.
- Return to LSB mode, set the **NOTCH** control fully CCW, and connect the RF millivoltmeter to TP2003. Adjust T2026 for peak (at least 700 mV_{rms}) on the meter.

4th Local Amplifier Level

In the LSB mode, set the **NOTCH** control to the 12-o'clock position, and connect the RF millivoltmeter to TP2004. Adjust T2025 for peak (at least 380 mV_{rms}) on the meter.

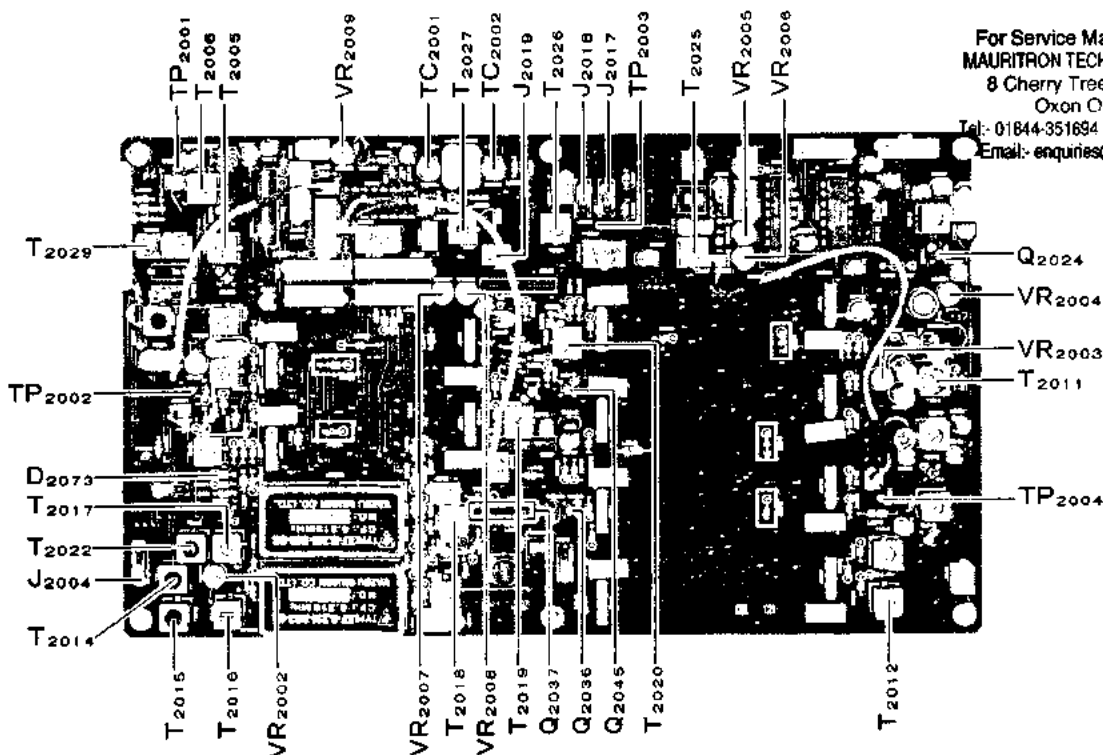

For Service Manuals Contact
MAURITRON TECHNICAL SERVICES
 8 Cherry Tree Rd. Chinnor
 Oxon OX9 4QY
 Tel: 01844-351694 Fax: 01844-352554
 Email: enquiries@mauritron.co.uk

IF Unit: Receiver Test & Alignment Points

4th LO Premix 12.635-MHz BPF Level Check

Connect the RF millivoltmeter to J2017 (without removing the plug) and confirm at least 85 mV_{rms}.

4th LO Premix 12.28-MHz VCXO Level Check

Connect the RF millivoltmeter to J2018 (without removing the plug) and confirm at least 500 mV_{rms}.

2nd Local Amplifier Level

Connect the RF millivoltmeter to TP2002 and adjust T2022 for peak (at least 400 mV_{rms}).

AF Unit

BFO PLL

Connect the DC voltmeter to TP3003 and adjust TC3001 for 5.0 ± 0.2 V on the meter.

Receiver BFO

Select the LSB mode, and set the NOTCH control fully CCW. Connect the RF millivoltmeter to the wiper arm (center contact) of VR3001 and adjust T3001 for maximum (at least 480 mV_{rms}).

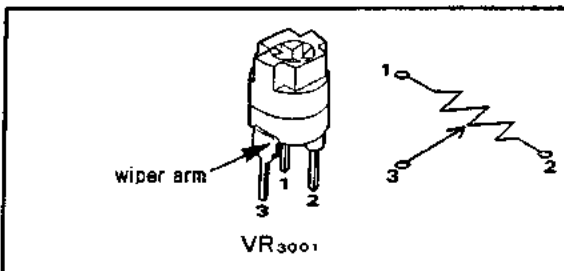

SSB Carrier Balance

Connect the RF millivoltmeter to the drain of Q2024 and adjust VR3001 for minimum voltage.

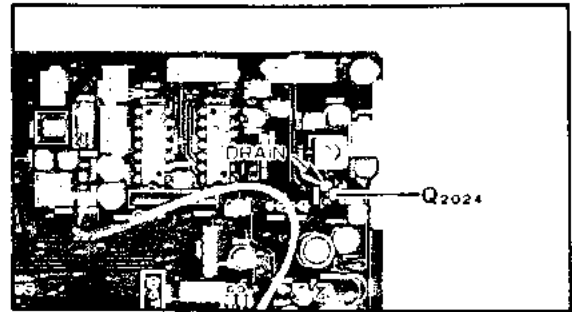

1st Mixer Balance

With LSB mode selected, tune the transceiver to the heterodyne at 655 kHz, and adjust VR1002 and VR1003 on the RF Unit for minimum heterodyne level (see below).

Mixer Balance Trimmer Locations on RF Unit

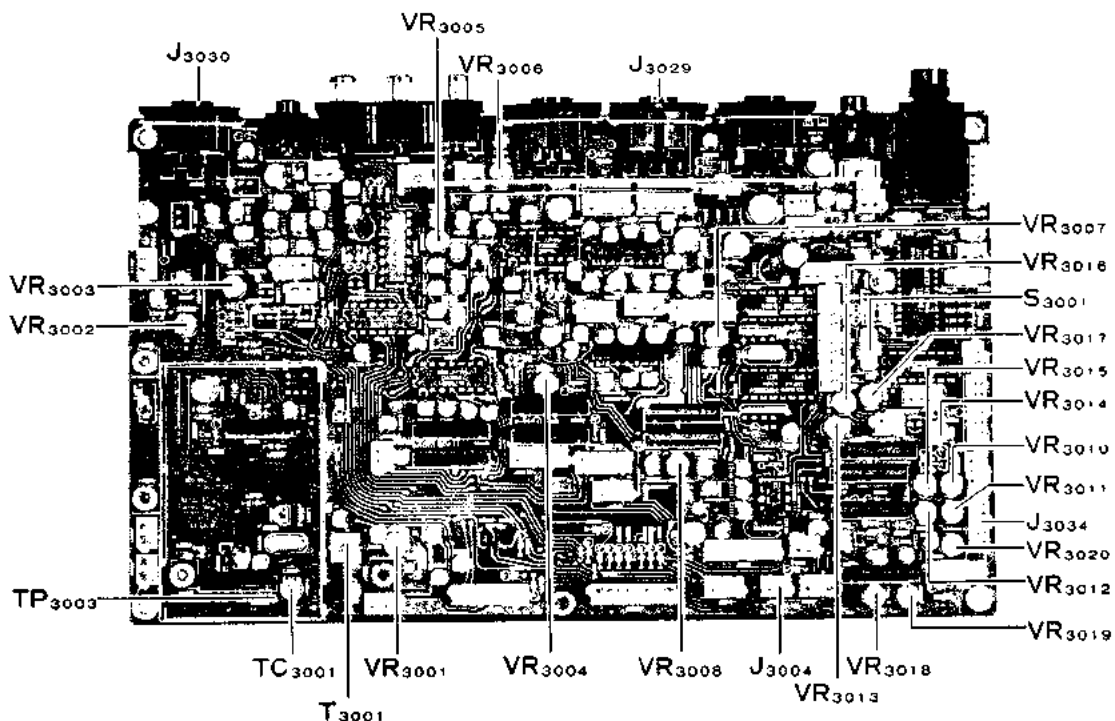
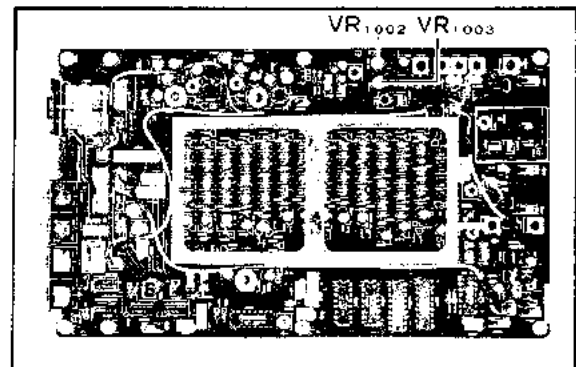

AF Unit: Receiver Test & Alignment Points

Main Rx RF & IF Interstage Transformers

With the RF signal generator connected to the main ANT jack, inject 80 dBμ at 14.2 MHz. Tune the transceiver to the signal, USB mode, and adjust T1010 - T1014 on the RF Unit for maximum S-meter deflection. Then adjust T2001 - T2004, T2007 - T2010, T2013 and T2030 for maximum deflection. Reduce the injection level, if necessary, to keep the S-meter near mid-scale.

RF AGC

With the RF signal generator and transceiver set up as in the previous procedure, connect the DC voltmeter to L1085 and adjust VR1001 for 0.7 ± 0.1 V.

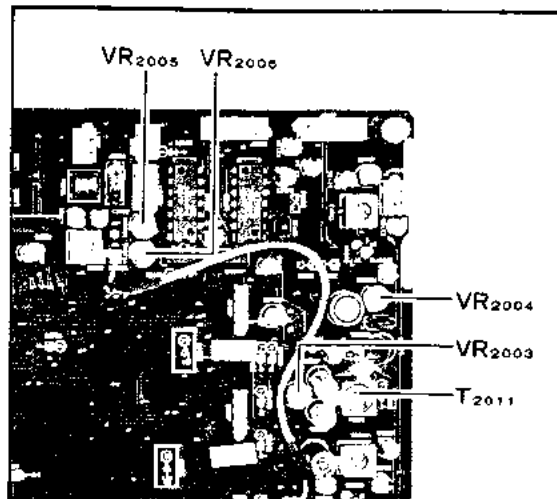

S-Meter Calibration & IF Gain

- With the same signal generator and transceiver setup as above, reduce the injection level to nil and adjust VR2006 just to the point where the S-meter begins to deflect with the RF gain control fully clockwise.
- Turn the RF gain fully counterclockwise, and adjust VR2005 for S9 +60 (full scale) on the S-meter.
- Return the RF gain fully clockwise, set the injection level to 8 dBμ and adjust VR2004 for S-1 deflection on the S-meter. Increase the injection to 100 dBμ and adjust VR2005 (again) for S9 +60 (full scale) on the S-meter.

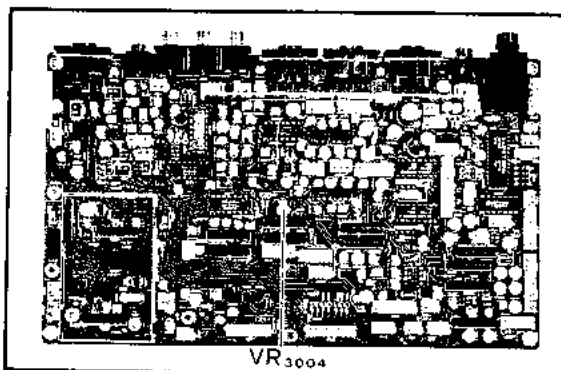
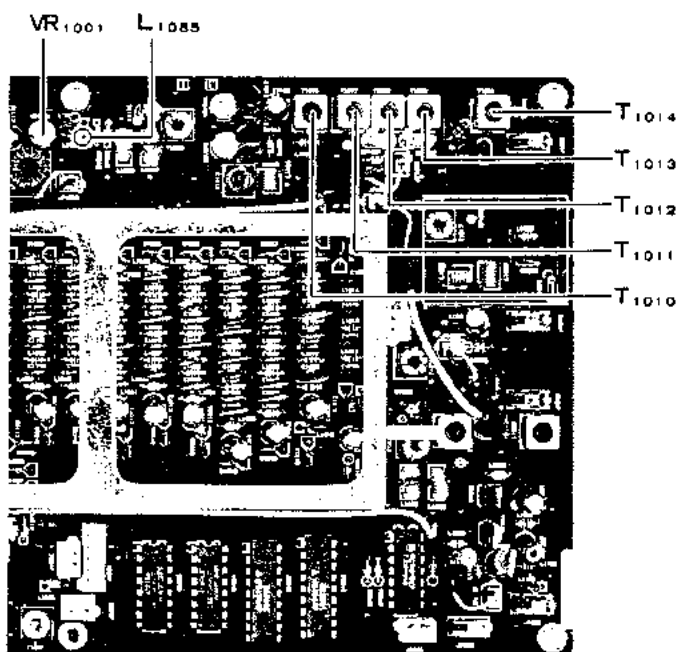
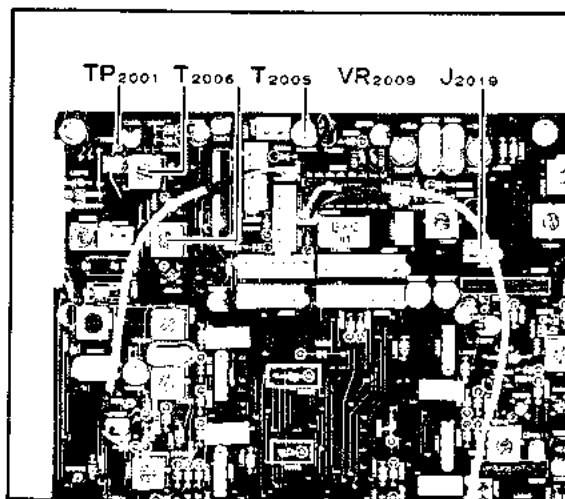

RF Unit: Receiver Alignment Points

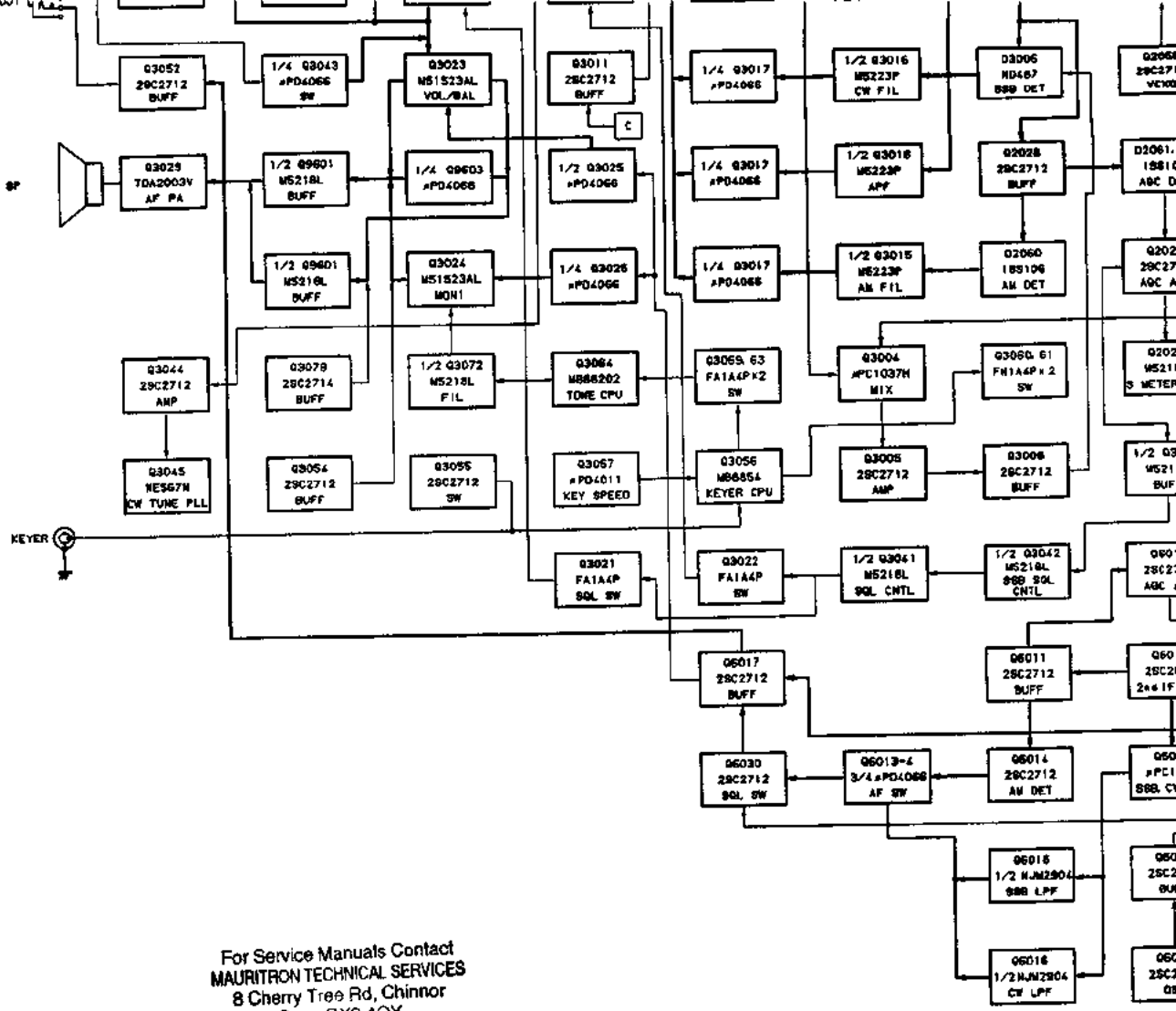

For Service Manuals Contact
MAURITRON TECHNICAL SERVICES
 8 Cherry Tree Rd, Chinnor
 Oxon OX9 4QY
 Tel:- 01844-351694 Fax:- 01844-352554
 Email:- enquiries@mauritron.co.uk

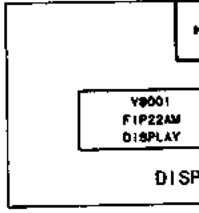
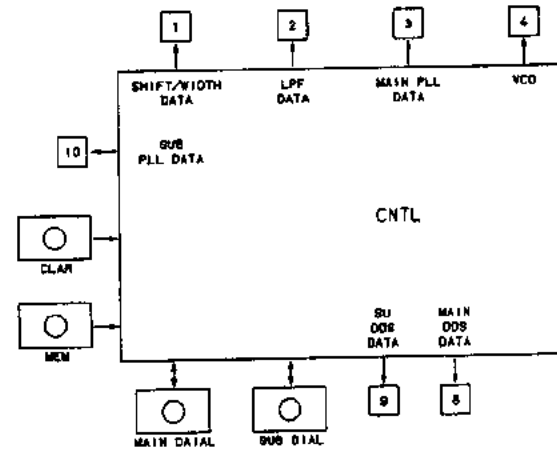

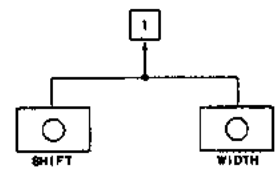
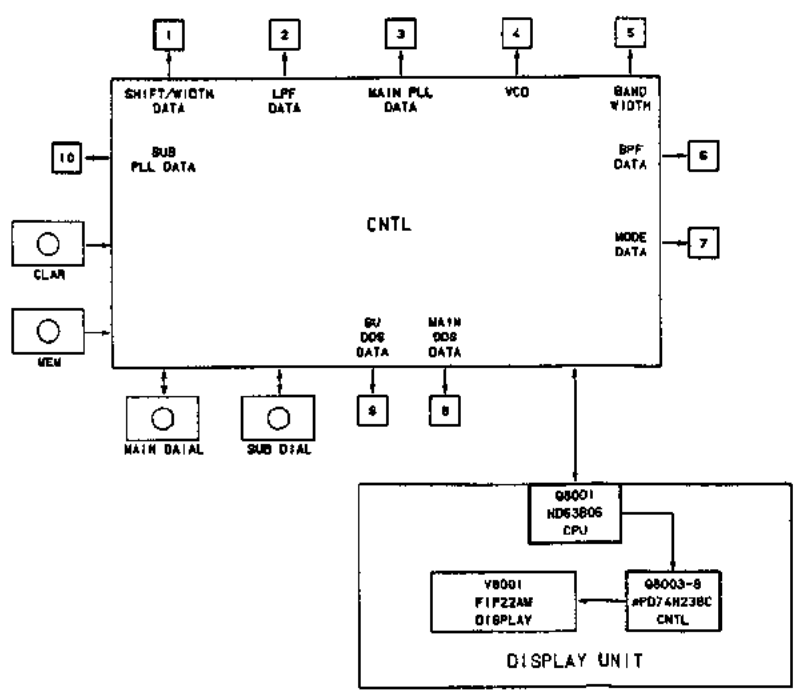
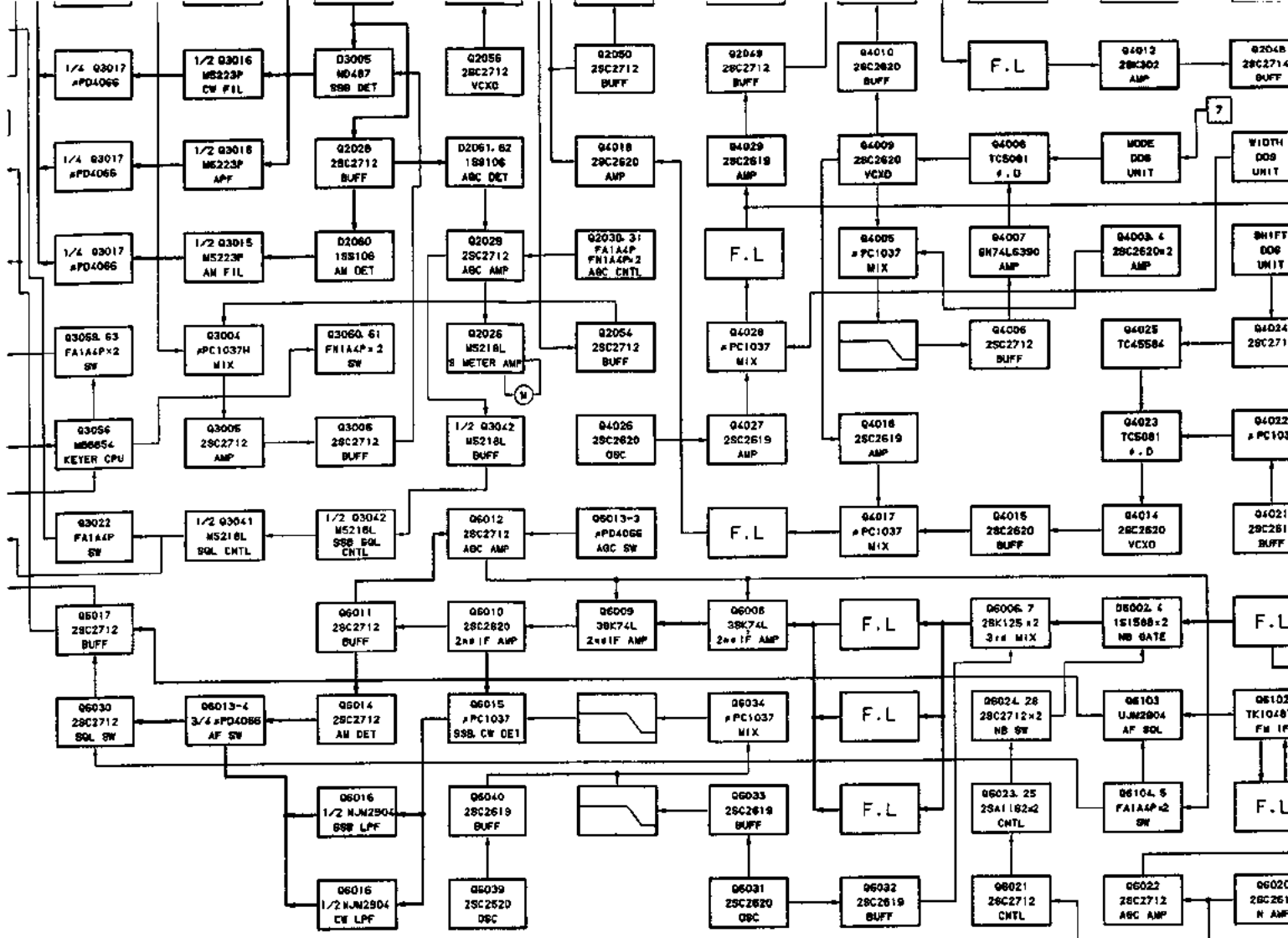

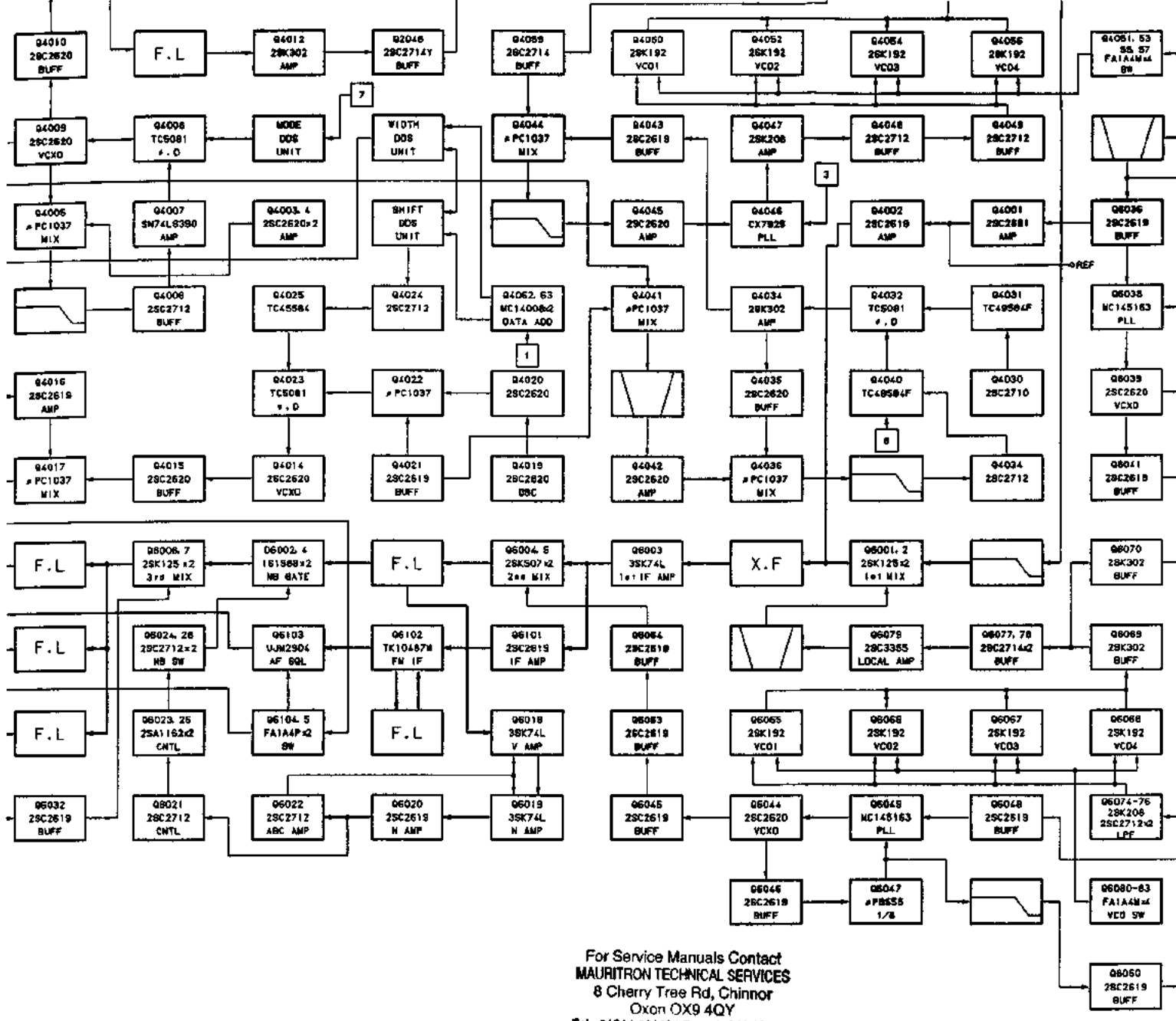

For Service Manuals Contact
MAURITRON TECHNICAL SERVICES
 8 Cherry Tree Rd, Chinnor
 Oxon OX9 4QY
 Tel: 01844-351694 Fax: 01844-352554
 Email: enquiries@mauritron.co.uk

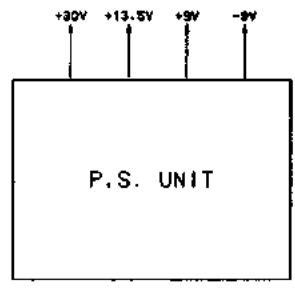
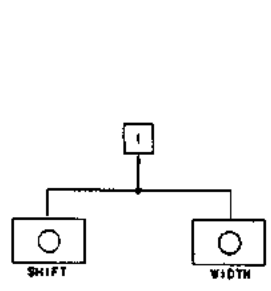

- RECEIVE
- - - TRANSMIT
- CONTROL

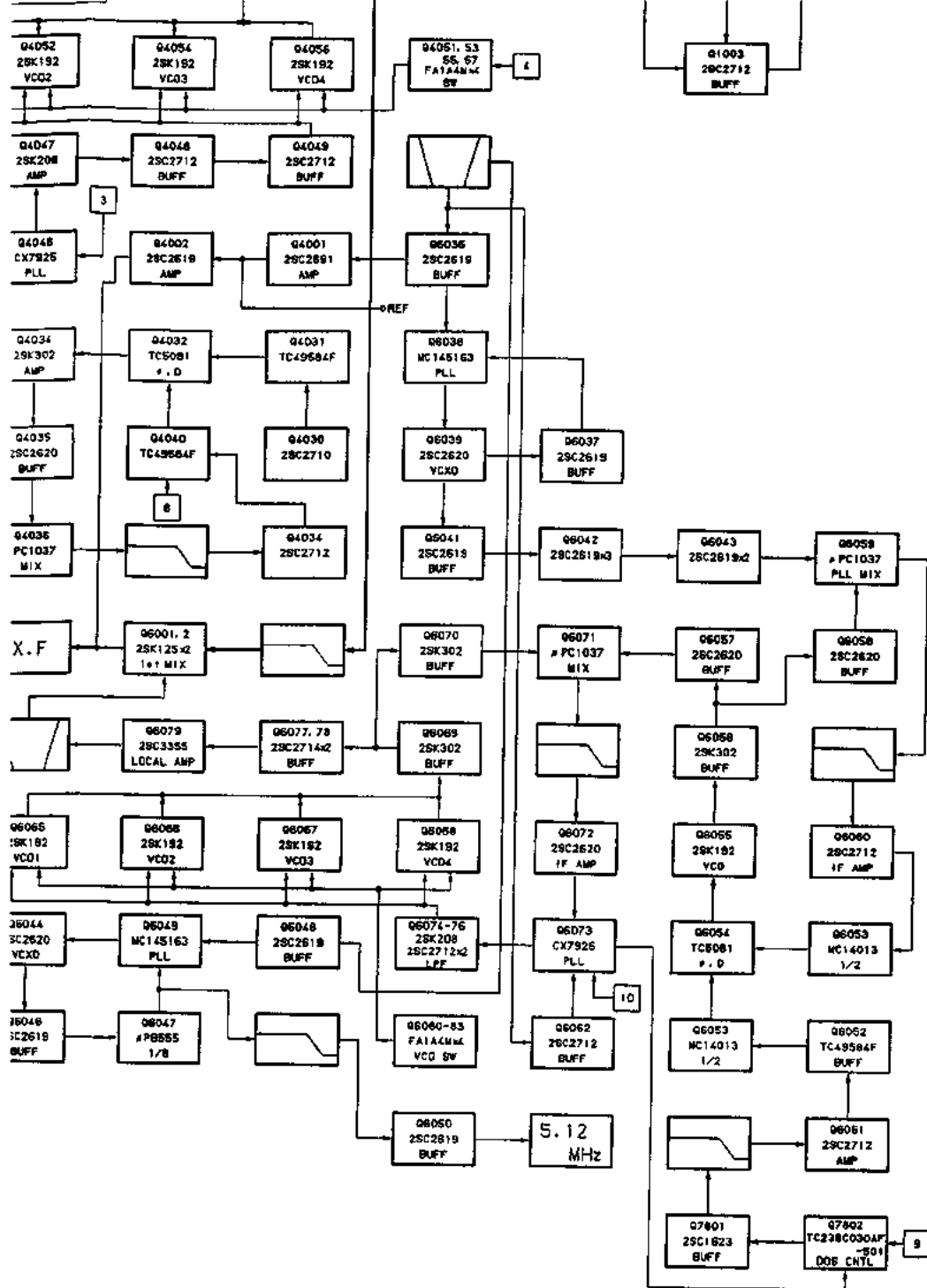

OVERALL BLOCK DIAGRAM

CONNECTION-DIAGRAM

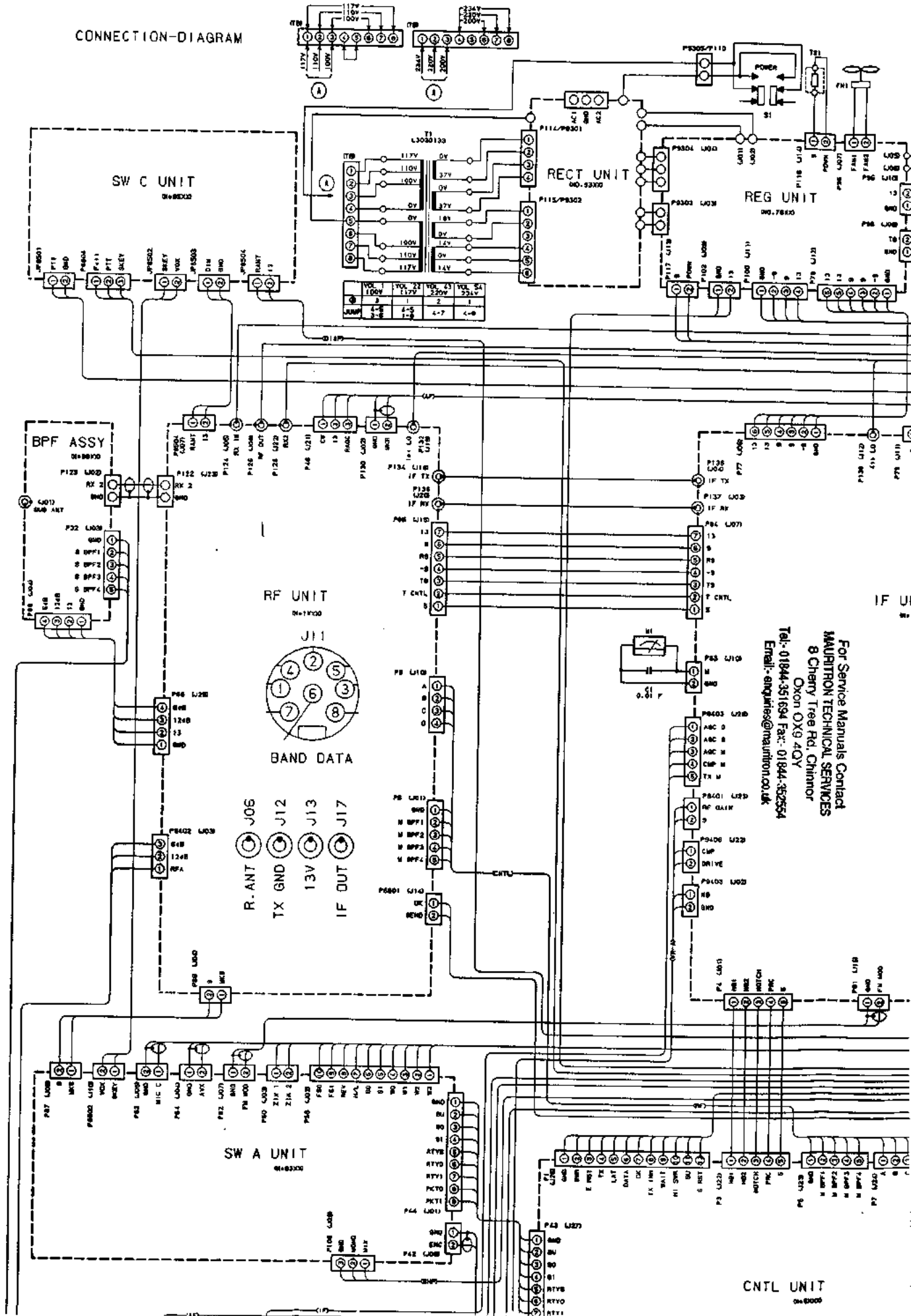

For Service Manuals Contact
MAURITRON TECHNICAL SERVICES
 8 Cherry Tree Rd, Chinnor
 Oxon OX9 4QY
 Tel: 01844-351694 Fax: 01844-352554
 Email: enquiries@mauritron.co.uk

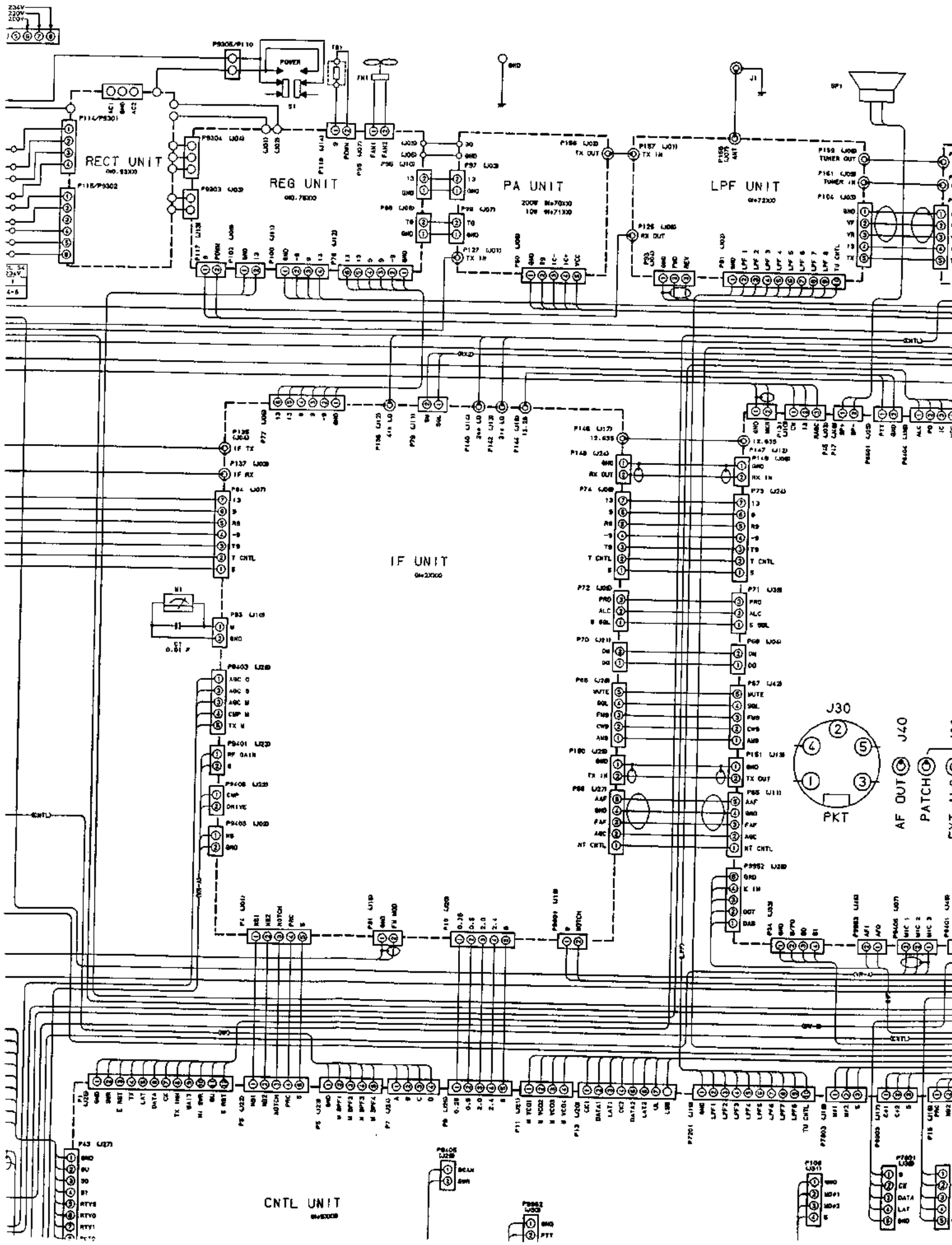

RECT UNIT
MO. 69300

REG UNIT
MO. 78300

PA UNIT
200W 8670300
10W 8671300

LPF UNIT
6472300

IF UNIT
642000

CNTL UNIT
645200

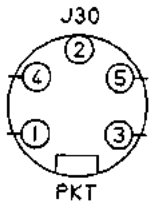

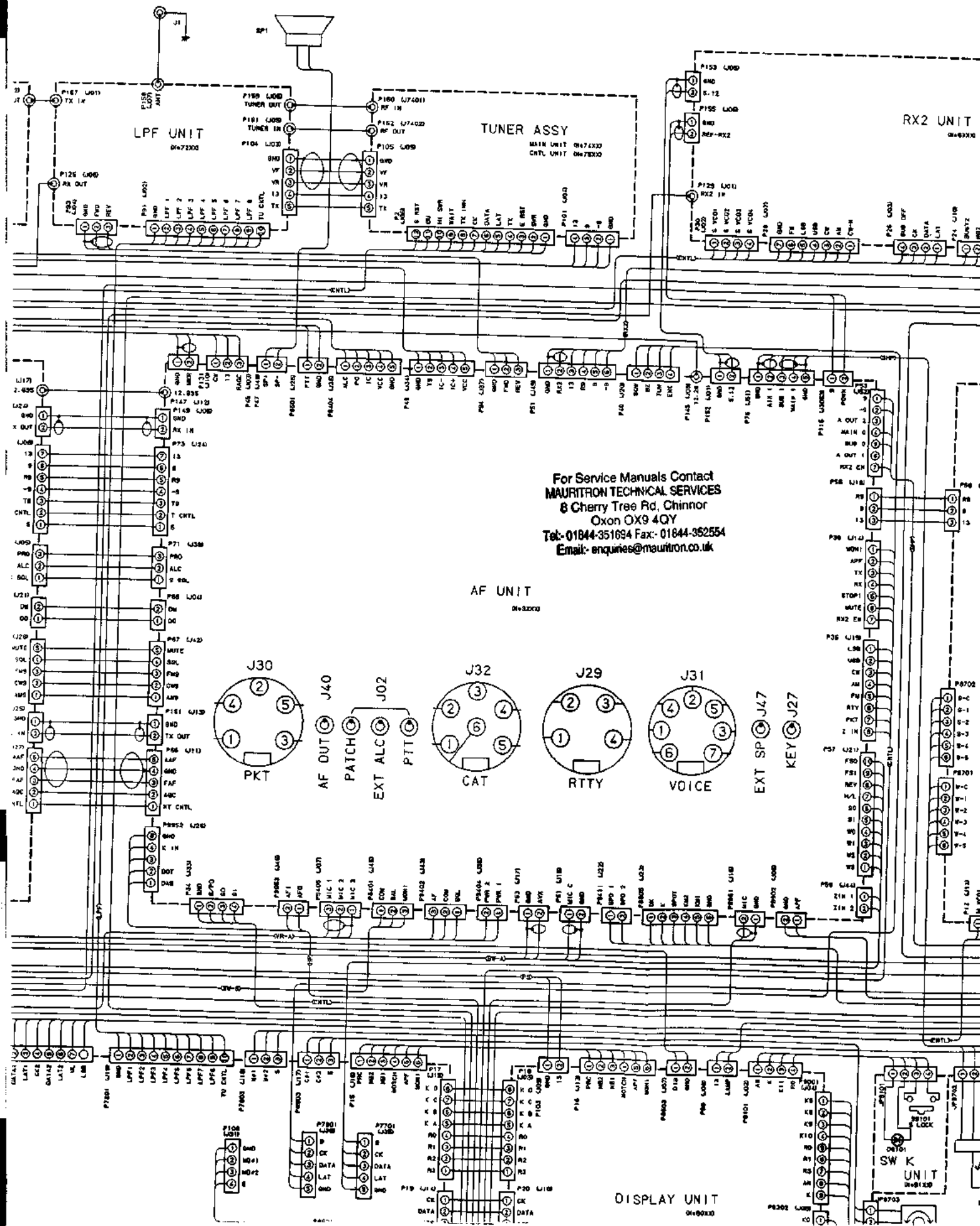

For Service Manuals Contact
MAURITRON TECHNICAL SERVICES
 8 Cherry Tree Rd, Chinnor
 Oxon OX9 4QY
 Tel: 01844-351694 Fax: 01844-352554
 Email: enquiries@mauritron.co.uk

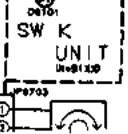
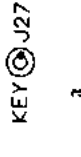
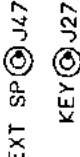
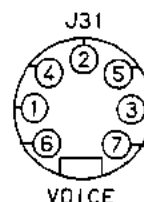
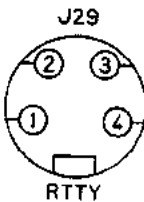
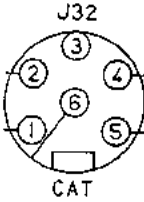
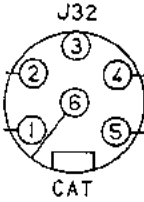
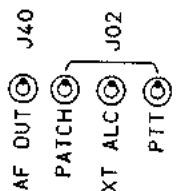

DISPLAY UNIT
 D100233

PCB Interconnection Diagram

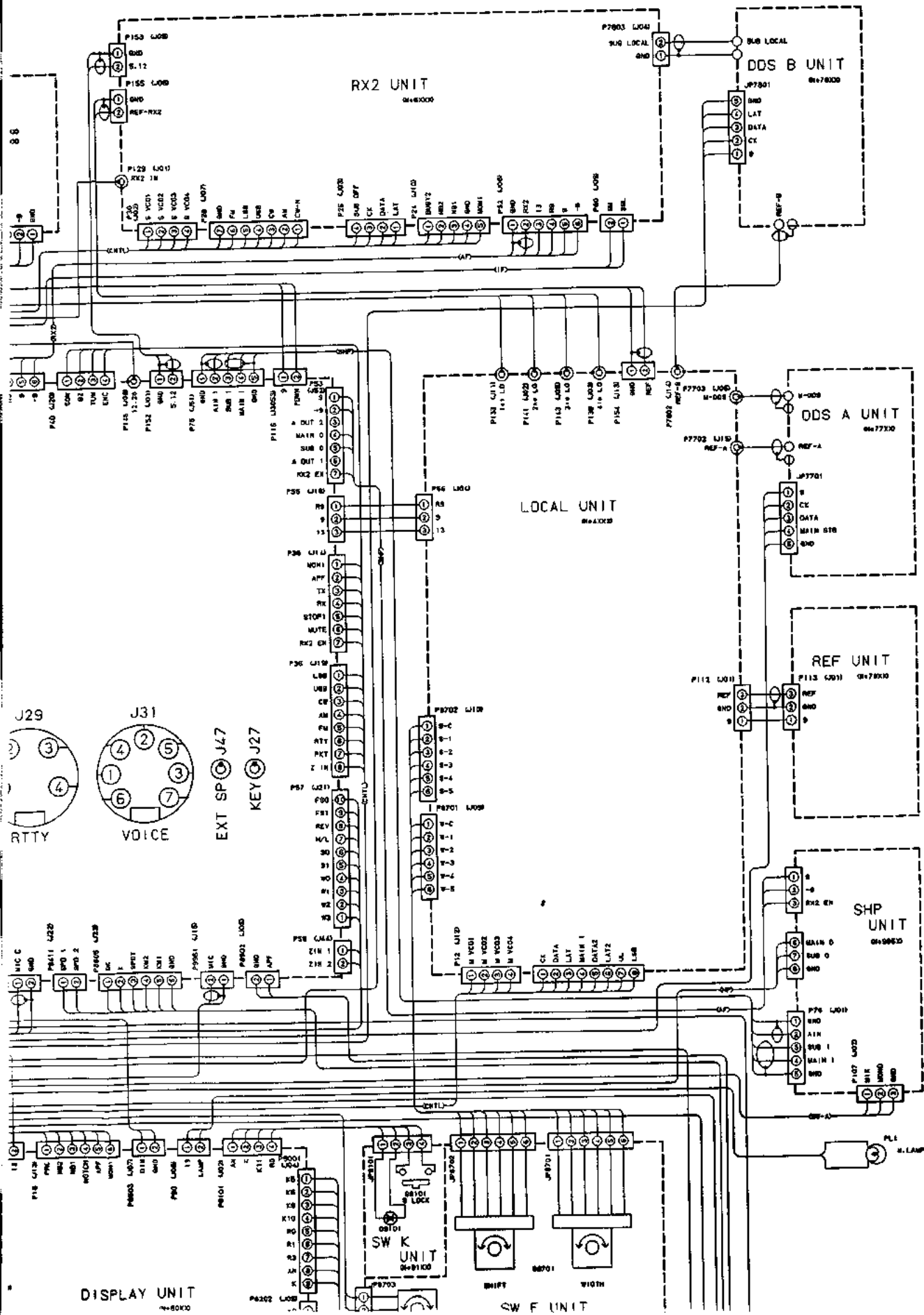

For Service Manuals Contact
MAURITRON TECHNICAL SERVICES
 8 Cherry Tree Rd, Chinnor
 Oxon OX9 4QY
 Tel: 01844-351694 Fax: 01844-352554
 Email: enquiries@mauritron.co.uk

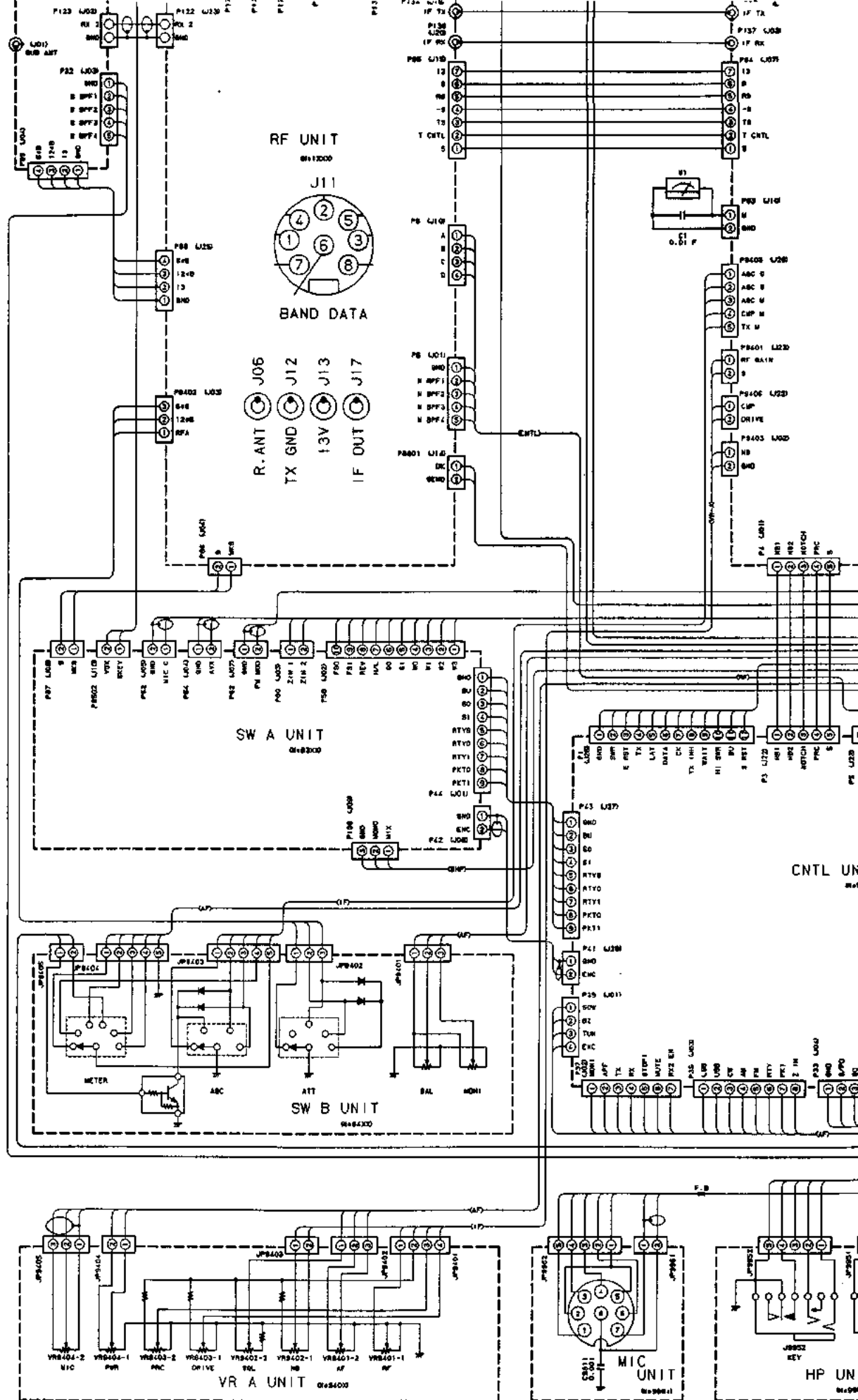

NOTE:
 CAPACITOR VALUES ARE IN μ F. 50V
 UNLESS OTHERWISE NOTED.

IF UNIT 042500

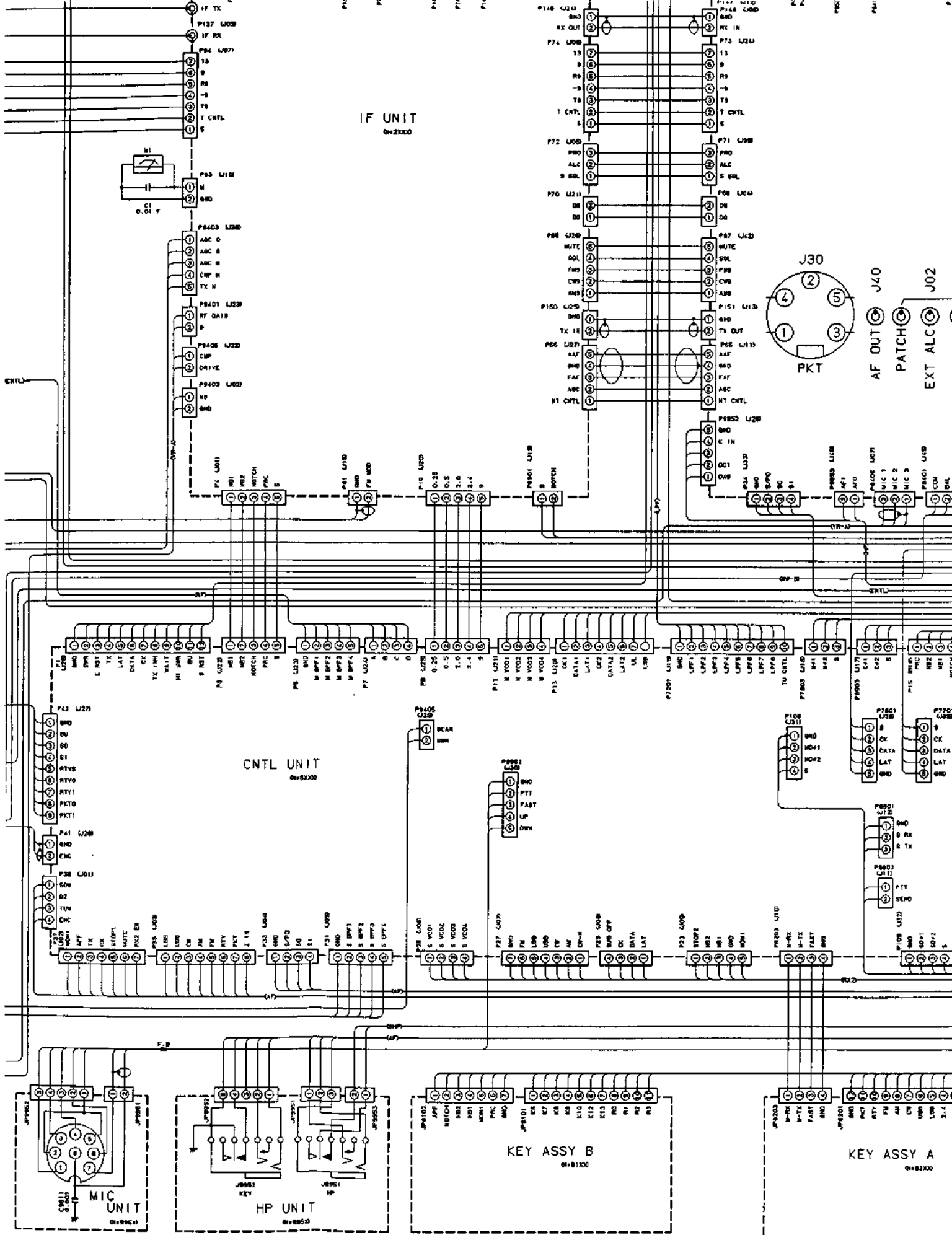

NOTE:
CAPACITOR VALUES ARE IN μ F, 50V,
UNLESS OTHERWISE NOTED.

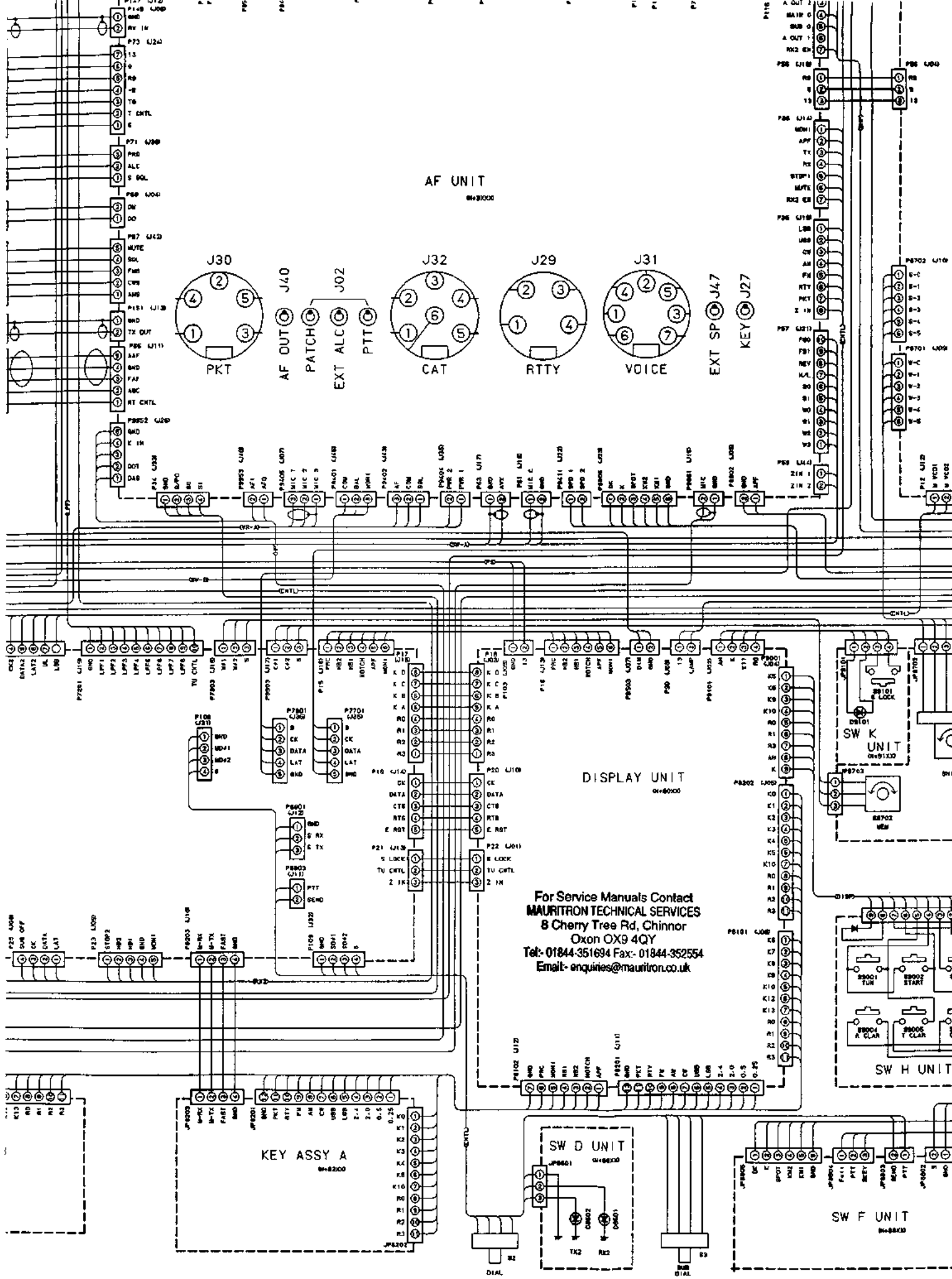

AF UNIT
04-0000

DISPLAY UNIT
04-0000

For Service Manuals Contact
MAURITRON TECHNICAL SERVICES
 8 Cherry Tree Rd, Chinnor
 Oxon OX9 4QY
 Tel: 01844-351694 Fax: 01844-352554
 Email: enquires@mauritron.co.uk

KEY ASSY A
04-0200

SW D UNIT
04-0000

SW F UNIT
04-0000

SW H UNIT

SW K UNIT
04-0100

RF Unit Parts List

ADD	CODE NO	DESCRIPTION	DEVICE	TYP	VAL
** UNIT NAME : RF-UNIT					
C 1001	K22170817	CHIP CAP.	GRM40B103M50PT	0.01uF	50V B
C 1002	K22171008	CHIP CAP.	GRM40F473Z50PT	0.047uF	50V F
C 1003	K22170227	CHIP CAP.	GRM40CH470J50PT	47pF	50V CH
C 1004	K22170206	CHIP CAP.	GRM40CH050C50PT	5pF	50V CH
C 1005	K22170817	CHIP CAP.	GRM40B103M50PT	0.01uF	50V B
C 1006	K22170817	CHIP CAP.	GRM40B103M50PT	0.01uF	50V B
C 1007	K22170817	CHIP CAP.	GRM40B103M50PT	0.01uF	50V B
C 1008	K22170817	CHIP CAP.	GRM40B103M50PT	0.01uF	50V B
C 1009	K22170817	CHIP CAP.	GRM40B103M50PT	0.01uF	50V B
C 1010	K22170817	CHIP CAP.	GRM40B103M50PT	0.01uF	50V B
C 1011	K22172009	CHIP CAP.	GRM42-6F104Z50PT	0.1uF	50V F
C 1012	K22171008	CHIP CAP.	GRM40F473Z50PT	0.047uF	50V F
C 1014	K22170231	CHIP CAP.	GRM40CH680J50PT	68pF	50V CH
C 1015	K22170219	CHIP CAP.	GRM40CH220J50PT	22pF	50V CH
C 1016	K22170239	CHIP CAP.	GRM40CH151J50PT	150pF	50V CH
C 1017	K22170207	CHIP CAP.	GRM40CH060D50PT	6pF	50V CH
C 1018	K22170231	CHIP CAP.	GRM40CH680J50PT	68pF	50V CH
C 1020	K46170021	AL. ELECTRO. CAP.	50V100M5X11TR5	10uF	50V
C 1021	K22171008	CHIP CAP.	GRM40F473Z50PT	0.047uF	50V F
C 1022	K22171008	CHIP CAP.	GRM40F473Z50PT	0.047uF	50V F
C 1023	K46170021	AL. ELECTRO. CAP.	50V100M5X11TR5	10uF	50V
C 1024	K22171008	CHIP CAP.	GRM40F473Z50PT	0.047uF	50V F
C 1025	K26171039	CERAMIC CAP.	DD107-979SL271J50	270pF	50V SL
C 1026	K26171039	CERAMIC CAP.	DD107-979SL271J50	270pF	50V SL
C 1027	K22171008	CHIP CAP.	GRM40F473Z50PT	0.047uF	50V F
C 1028	K22170817	CHIP CAP.	GRM40B103M50PT	0.01uF	50V B
C 1029	K46170021	AL. ELECTRO. CAP.	50V100M5X11TR5	10uF	50V
C 1030	K26170703	CERAMIC CAP.	UAU04X152K7L36VC	0.0015	50V X
C 1031	K26170706	CERAMIC CAP.	UAU05X272K7L36VC	0.0027	50V X
C 1032	K26170706	CERAMIC CAP.	UAU05X272K7L36VC	0.0027	50V X
C 1033	K26170703	CERAMIC CAP.	UAU04X152K7L36VC	0.0015	50V X
C 1034	K46170021	AL. ELECTRO. CAP.	50V100M5X11TR5	10uF	50V
C 1035	K22170817	CHIP CAP.	GRM40B103M50PT	0.01uF	50V B
C 1036	K00175511	CERAMIC CAP.	DD109SL511J50	510p	50V SL
C 1037	K26170701	CERAMIC CAP.	UAU04X102K7L36VC	0.001uF	50V X
C 1038	K00179019	CERAMIC CAP.	DD106SL201J50	200p	50V SL
C 1039	K00175621	CERAMIC CAP.	DD110SL621J50	620p	50V SL
C 1040	K26170701	CERAMIC CAP.	UAU04X102K7L36VC	0.001uF	50V X
C 1041	K00175511	CERAMIC CAP.	DD109SL511J50	510p	50V SL
C 1042	K22171008	CHIP CAP.	GRM40F473Z50PT	0.047uF	50V F
C 1043	K46170021	AL. ELECTRO. CAP.	50V100M5X11TR5	10uF	50V
C 1044	K22170817	CHIP CAP.	GRM40B103M50PT	0.01uF	50V B
C 1045	K26171043	CERAMIC CAP.	DD108-979SL391J50	390pF	50V SL
C 1046	K26171043	CERAMIC CAP.	DD108-979SL391J50	390pF	50V SL
C 1047	K26171033	CERAMIC CAP.	DD106-979SL151J50	150pF	50V SL
C 1048	K26170703	CERAMIC CAP.	UAU04X152K7L36VC	0.0015	50V X
C 1049	K26171033	CERAMIC CAP.	DD106-979SL151J50	150pF	50V SL
C 1050	K26171043	CERAMIC CAP.	DD108-979SL391J50	390pF	50V SL
C 1051	K26171043	CERAMIC CAP.	DD108-979SL391J50	390pF	50V SL
C 1052	K22171008	CHIP CAP.	GRM40F473Z50PT	0.047uF	50V F
C 1053	K46170021	AL. ELECTRO. CAP.	50V100M5X11TR5	10uF	50V
C 1054	K22170817	CHIP CAP.	GRM40B103M50PT	0.01uF	50V B
C 1055	K26171043	CERAMIC CAP.	DD108-979SL391J50	390pF	50V SL
C 1056	K26171033	CERAMIC CAP.	DD106-979SL151J50	150pF	50V SL
C 1057	K00179017	CERAMIC CAP.	DD105-257SL131J50	130p	50V SL
C 1058	K26171046	CERAMIC CAP.	DD109-979SL471J50	470pF	50V SL
C 1059	K26171046	CERAMIC CAP.	DD109-979SL471J50	470pF	50V SL
C 1060	K00179017	CERAMIC CAP.	DD105-257SL131J50	130p	50V SL
C 1061	K26171033	CERAMIC CAP.	DD106-979SL151J50	150pF	50V SL
C 1062	K26171043	CERAMIC CAP.	DD108-979SL391J50	390pF	50V SL
C 1063	K22171008	CHIP CAP.	GRM40F473Z50PT	0.047uF	50V F
C 1064	K46170021	AL. ELECTRO. CAP.	50V100M5X11TR5	10uF	50V
C 1065	K22170817	CHIP CAP.	GRM40B103M50PT	0.01uF	50V B
C 1066	K26171043	CERAMIC CAP.	DD108-979SL391J50	390pF	50V SL
C 1067	K00179015	CERAMIC CAP.	DD105SL111J50	110p	50V SL
C 1068	K26171045	CERAMIC CAP.	DD109-979SL471J50	470pF	50V SL
C 1069	K00179021	CERAMIC CAP.	DD107SL301J50	300p	50V SL
C 1070	K00179015	CERAMIC CAP.	DD105SL111J50	110p	50V SL
C 1071	K26171043	CERAMIC CAP.	DD108-979SL391J50	390pF	50V SL
C 1072	K22171008	CHIP CAP.	GRM40F473Z50PT	0.047uF	50V F
C 1073	K46170021	AL. ELECTRO. CAP.	50V100M5X11TR5	10uF	50V
C 1074	K22170817	CHIP CAP.	GRM40B103M50PT	0.01uF	50V B
C 1075	K00179020	CERAMIC CAP.	DD107SL241J50	240p	50V SL
C 1076	K26171027	CERAMIC CAP.	DD104-979SL820J50	82pF	50V SL
C 1077	K26171045	CERAMIC CAP.	DD109-979SL471J50	470pF	50V SL
C 1078	K26171027	CERAMIC CAP.	DD104-979SL820J50	82pF	50V SL
C 1079	K00179020	CERAMIC CAP.	DD107SL241J50	240p	50V SL
C 1080	K22171008	CHIP CAP.	GRM40F473Z50PT	0.047uF	50V F
C 1081	K46170021	AL. ELECTRO. CAP.	50V100M5X11TR5	10uF	50V
C 1082	K22170817	CHIP CAP.	GRM40B103M50PT	0.01uF	50V B
C 1083	K26171039	CERAMIC CAP.	DD107-979SL271J50	270pF	50V SL
C 1084	K00179008	CERAMIC CAP.	DD104SL360J50	36p	50V SL

RF Unit Parts List

ADD	CODE NO	DESCRIPTION	DEVICE			TYP	VAL
C 1085	K26171045	CERAMIC CAP.	DD109-979SL471J50	470pF	50V	SL	
C 1087	K00179008	CERAMIC CAP.	DD104SL360J50	36p	50V	SL	
C 1088	K26171039	CERAMIC CAP.	DD107-979SL271J50	270pF	50V	SL	
C 1089	K22171008	CHIP CAP.	GRM40F473Z50PT	0.047uF	50V	F	
C 1090	K46170021	AL. ELECTRO. CAP.	50V100M5X11TR5	10uF	50V		
C 1091	K22170817	CHIP CAP.	GRM40B103M50PT	0.01uF	50V	B	
C 1092	K26171039	CERAMIC CAP.	DD107-979SL271J50	270pF	50V	SL	
C 1093	K00179008	CERAMIC CAP.	DD104SL360J50	36p	50V	SL	
C 1094	K26171047	CERAMIC CAP.	DD109-979SL561J50	560pF	50V	SL	
C 1095	K00179008	CERAMIC CAP.	DD104SL360J50	36p	50V	SL	
C 1096	K26171039	CERAMIC CAP.	DD107-979SL271J50	270pF	50V	SL	
C 1097	K22171008	CHIP CAP.	GRM40F473Z50PT	0.047uF	50V	F	
C 1098	K46170021	AL. ELECTRO. CAP.	50V100M5X11TR5	10uF	50V		
C 1099	K22170817	CHIP CAP.	GRM40B103M50PT	0.01uF	50V	B	
C 1100	K26171033	CERAMIC CAP.	DD106-979SL151J50	150pF	50V	SL	
C 1101	K26171011	CERAMIC CAP.	DD104-979SL180J50	18pF	50V	SL	
C 1102	K26171041	CERAMIC CAP.	DD107-979SL331J50	330pF	50V	SL	
C 1103	K26171011	CERAMIC CAP.	DD104-979SL180J50	18pF	50V	SL	
C 1104	K26171033	CERAMIC CAP.	DD106-979SL151J50	150pF	50V	SL	
C 1105	K22171008	CHIP CAP.	GRM40F473Z50PT	0.047uF	50V	F	
C 1106	K46170021	AL. ELECTRO. CAP.	50V100M5X11TR5	10uF	50V		
C 1107	K22170817	CHIP CAP.	GRM40B103M50PT	0.01uF	50V	B	
C 1108	K26171033	CERAMIC CAP.	DD106-979SL151J50	150pF	50V	SL	
C 1110	K26171011	CERAMIC CAP.	DD104-979SL180J50	18pF	50V	SL	
C 1111	K00179021	CERAMIC CAP.	DD107SL301J50	300p	50V	SL	
C 1112	K26171011	CERAMIC CAP.	DD104-979SL180J50	18pF	50V	SL	
C 1114	K26171033	CERAMIC CAP.	DD106-979SL151J50	150pF	50V	SL	
C 1115	K22171008	CHIP CAP.	GRM40F473Z50PT	0.047uF	50V	F	
C 1116	K46170021	AL. ELECTRO. CAP.	50V100M5X11TR5	10uF	60V		
C 1117	K22170817	CHIP CAP.	GRM40B103M50PT	0.01uF	50V	B	
C 1118	K00179020	CERAMIC CAP.	DD107SL241J50	240p	50V	SL	
C 1119	K26171011	CERAMIC CAP.	DD104-979SL180J50	18pF	50V	SL	
C 1120	K26171041	CERAMIC CAP.	DD107-979SL331J50	330pF	50V	SL	
C 1121	K26171027	CERAMIC CAP.	DD104-979SL820J50	82pF	50V	SL	
C 1122	K26171011	CERAMIC CAP.	DD104-979SL180J50	18pF	50V	SL	
C 1123	K00179020	CERAMIC CAP.	DD107SL241J50	240p	50V	SL	
C 1124	K22171008	CHIP CAP.	GRM40F473Z50PT	0.047uF	50V	F	
C 1125	K46170021	AL. ELECTRO. CAP.	50V100M5X11TR5	10uF	50V		
C 1126	K22170817	CHIP CAP.	GRM40B103M50PT	0.01uF	50V	B	
C 1127	K26171033	CERAMIC CAP.	DD106-979SL151J50	150pF	50V	SL	
C 1128	K00179003	CERAMIC CAP.	DD104SL130J50	13p	50V	SL	
C 1129	K26171041	CERAMIC CAP.	DD107-979SL331J50	330pF	50V	SL	
C 1130	K00179003	CERAMIC CAP.	DD104SL130J50	13p	50V	SL	
C 1131	K26171033	CERAMIC CAP.	DD106-979SL151J50	150pF	50V	SL	
C 1132	K22171008	CHIP CAP.	GRM40F473Z50PT	0.047uF	50V	F	
C 1133	K46170021	AL. ELECTRO. CAP.	50V100M5X11TR5	10uF	50V		
C 1134	K22170817	CHIP CAP.	GRM40B103M50PT	0.01uF	50V	B	
C 1135	K26171029	CERAMIC CAP.	DD105-979SL101J50	100pF	50V	SL	
C 1136	K26171005	CERAMIC CAP.	DD104-979SL100D50	10pF	50V	SL	
C 1137	K26171035	CERAMIC CAP.	DD106-979SL181J50	180pF	50V	SL	
C 1138	K26171005	CERAMIC CAP.	DD104-979SL100D50	10pF	50V	SL	
C 1139	K26171029	CERAMIC CAP.	DD105-979SL101J50	100pF	50V	SL	
C 1140	K22171008	CHIP CAP.	GRM40F473Z50PT	0.047uF	50V	F	
C 1141	K46170021	AL. ELECTRO. CAP.	50V100M5X11TR5	10uF	50V		
C 1142	K22170817	CHIP CAP.	GRM40B103M50PT	0.01uF	50V	B	
C 1143	K00179010	CERAMIC CAP.	DD104SL510J50	51p	50V	SL	
C 1144	K26171004	CERAMIC CAP.	DD104-979SL090D50	9pF	50V	SL	
C 1145	K26171029	CERAMIC CAP.	DD105-979SL101J50	100pF	50V	SL	
C 1146	K26171004	CERAMIC CAP.	DD104-979SL090D50	9pF	50V	SL	
C 1147	K00179010	CERAMIC CAP.	DD104SL510J50	51p	50V	SL	
C 1148	K22171008	CHIP CAP.	GRM40F473Z50PT	0.047uF	50V	F	
C 1149	K46170021	AL. ELECTRO. CAP.	50V100M5X11TR5	10uF	50V		
C 1150	K22171008	CHIP CAP.	GRM40F473Z50PT	0.047uF	50V	F	
C 1151	K22171008	CHIP CAP.	GRM40F473Z50PT	0.047uF	50V	F	
C 1152	K46170021	AL. ELECTRO. CAP.	50V100M5X11TR5	10uF	50V		
C 1153	K22171008	CHIP CAP.	GRM40F473Z50PT	0.047uF	50V	F	
C 1154	K46170021	AL. ELECTRO. CAP.	50V100M5X11TR5	10uF	50V		
C 1156	K22171008	CHIP CAP.	GRM40F473Z50PT	0.047uF	50V	F	
C 1157	K46170021	AL. ELECTRO. CAP.	50V100M5X11TR5	10uF	50V		
C 1158	K46170021	AL. ELECTRO. CAP.	50V100M5X11TR5	10uF	50V		
C 1159	K22171008	CHIP CAP.	GRM40F473Z50PT	0.047uF	50V	F	
C 1160	K22171008	CHIP CAP.	GRM40F473Z50PT	0.047uF	50V	F	
C 1161	K46170021	AL. ELECTRO. CAP.	50V100M5X11TR5	10uF	50V		
C 1162	K22171008	CHIP CAP.	GRM40F473Z50PT	0.047uF	50V	F	
C 1163	K46170021	AL. ELECTRO. CAP.	50V100M5X11TR5	10uF	50V		
C 1164	K22172009	CHIP CAP.	GRM42-6F104Z50PT	0.1uF	50V	F	
C 1165	K22172009	CHIP CAP.	GRM42-6F104Z50PT	0.1uF	50V	F	
C 1166	K22170817	CHIP CAP.	GRM40B103M50PT	0.01uF	50V	B	
C 1167	K22171008	CHIP CAP.	GRM40F473Z50PT	0.047uF	50V	F	
C 1168	K22171008	CHIP CAP.	GRM40F473Z50PT	0.047uF	50V	F	
C 1169	K46170030	AL. ELECTRO. CAP.	50V010M4X7TR2	1uF	50V		
C 1170	K22170229	CHIP CAP.	GRM40CH560J50PT	56pF	50V	CH	
C 1171	K22170219	CHIP CAP.	GRM40CH220J50PT	22pF	50V	CH	

For Service Manuals visit
MAURITRON TECHNICAL SERVICES
 8 Cherry Tree Rd, Chinnor
 Oxon OX9 4DY
 Tel: 01844-351694 Fax: 01844-352354
 Email: enquiries@mauritron.co.uk

RF Unit Parts List

ADD	CODE NO	DESCRIPTION	DEVICE			TYP VAL
C 1172	K22170239	CHIP CAP.	GRM40CH151J50PT	150pF	50V	CH
C 1173	K22170207	CHIP CAP.	GRM40CH060D50PT	6pF	50V	CH
C 1174	K22170231	CHIP CAP.	GRM40CH680J50PT	68pF	50V	CH
C 1175	K46170021	AL. ELECTRO. CAP.	50V100M5X11TR5	10uF	50V	
C 1176	K22171008	CHIP CAP.	GRM40F473Z50PT	0.047uF	50V	F
C 1177	K22171008	CHIP CAP.	GRM40F473Z50PT	0.047uF	50V	F
C 1178	K22171008	CHIP CAP.	GRM40F473Z50PT	0.047uF	50V	F
C 1179	K22171008	CHIP CAP.	GRM40F473Z50PT	0.047uF	50V	F
C 1180	K22171008	CHIP CAP.	GRM40F473Z50PT	0.047uF	50V	F
C 1181	K22170817	CHIP CAP.	GRM40B103M50PT	0.01uF	50V	B
C 1182	K46170021	AL. ELECTRO. CAP.	50V100M5X11TR5	10uF	50V	
C 1183	K22170227	CHIP CAP.	GRM40CH470J50PT	47pF	50V	CH
C 1184	K22170235	CHIP CAP.	GRM40CH101J50PT	100pF	50V	CH
C 1185	K22170235	CHIP CAP.	GRM40CH101J50PT	100pF	50V	CH
C 1186	K22170235	CHIP CAP.	GRM40CH101J50PT	100pF	50V	CH
C 1187	K22170817	CHIP CAP.	GRM40B103M50PT	0.01uF	50V	B
C 1188	K22170817	CHIP CAP.	GRM40B103M50PT	0.01uF	50V	B
C 1189	K22170817	CHIP CAP.	GRM40B103M50PT	0.01uF	50V	B
C 1190	K22170817	CHIP CAP.	GRM40B103M50PT	0.01uF	50V	B
C 1191	K22170235	CHIP CAP.	GRM40CH101J50PT	100pF	50V	CH
C 1192	K22170817	CHIP CAP.	GRM40B103M50PT	0.01uF	50V	B
C 1193	K22170239	CHIP CAP.	GRM40CH151J50PT	150pF	50V	CH
C 1194	K22170817	CHIP CAP.	GRM40B103M50PT	0.01uF	50V	B
C 1195	K22170817	CHIP CAP.	GRM40B103M50PT	0.01uF	50V	B
C 1196	K22170817	CHIP CAP.	GRM40B103M50PT	0.01uF	50V	B
C 1197	K22170219	CHIP CAP.	GRM40CH220J50PT	22pF	50V	CH
C 1198	K22170204	CHIP CAP.	GRM40CJ030C50PT	3pF	50V	CJ
C 1199	K22170225	CHIP CAP.	GRM40CH390J50PT	39pF	50V	CH
C 1200	K22170210	CHIP CAP.	GRM40CH090D50PT	9pF	50V	CH
C 1201	K22170219	CHIP CAP.	GRM40CH220J50PT	22pF	50V	CH
C 1202	K22170817	CHIP CAP.	GRM40B103M50PT	0.01uF	50V	B
C 1203	K22170817	CHIP CAP.	GRM40B103M50PT	0.01uF	50V	B
C 1206	K22170817	CHIP CAP.	GRM40B103M50PT	0.01uF	50V	B
C 1207	K22170817	CHIP CAP.	GRM40B103M50PT	0.01uF	50V	B
C 1208	K22170211	CHIP CAP.	GRM40CH100D50PT	10pF	50V	CH
C 1209	K22170817	CHIP CAP.	GRM40B103M50PT	0.01uF	50V	B
C 1210	K22170817	CHIP CAP.	GRM40B103M50PT	0.01uF	50V	B
C 1211	K22170235	CHIP CAP.	GRM40CH101J50PT	100pF	50V	CH
C 1215	K22170231	CHIP CAP.	GRM40CH680J50PT	68pF	50V	CH
C 1216	K22170207	CHIP CAP.	GRM40CH060D50PT	6pF	50V	CH
C 1217	K22170239	CHIP CAP.	GRM40CH151J50PT	150pF	50V	CH
C 1218	K22170217	CHIP CAP.	GRM40CH180J50PT	18pF	50V	CH
C 1219	K22170231	CHIP CAP.	GRM40CH680J50PT	68pF	50V	CH
C 1220	K22171008	CHIP CAP.	GRM40F473Z50PT	0.047uF	50V	F
C 1221	K46170021	AL. ELECTRO. CAP.	50V100M5X11TR5	10uF	50V	
C 1222	K22170817	CHIP CAP.	GRM40B103M50PT	0.01uF	50V	B
C 1223	K22171008	CHIP CAP.	GRM40F473Z50PT	0.047uF	50V	F
C 1224	K22170817	CHIP CAP.	GRM40B103M50PT	0.01uF	50V	B
C 1225	K22171008	CHIP CAP.	GRM40F473Z50PT	0.047uF	50V	F
C 1226	K22170817	CHIP CAP.	GRM40B103M50PT	0.01uF	50V	B
C 1227	K46170021	AL. ELECTRO. CAP.	50V100M5X11TR5	10uF	50V	
C 1228	K22171008	CHIP CAP.	GRM40F473Z50PT	0.047uF	50V	F
C 1231	K22171008	CHIP CAP.	GRM40F473Z50PT	0.047uF	50V	F
C 1233	K22170817	CHIP CAP.	GRM40B103M50PT	0.01uF	50V	B
C 1234	K22170817	CHIP CAP.	GRM40B103M50PT	0.01uF	50V	B
C 1235	K46170021	AL. ELECTRO. CAP.	50V100M5X11TR5	10uF	50V	
C 1236	K22170817	CHIP CAP.	GRM40B103M50PT	0.01uF	50V	B
C 1237	K22170817	CHIP CAP.	GRM40B103M50PT	0.01uF	50V	B
C 1238	K22170817	CHIP CAP.	GRM40B103M50PT	0.01uF	50V	B
C 1239	K22170817	CHIP CAP.	GRM40B103M50PT	0.01uF	50V	B
C 1240	K22170817	CHIP CAP.	GRM40B103M50PT	0.01uF	50V	B
C 1241	K22170817	CHIP CAP.	GRM40B103M50PT	0.01uF	50V	B
C 1242	K22170817	CHIP CAP.	GRM40B103M50PT	0.01uF	50V	B
C 1243	K22170821	CHIP CAP.	GRM40B223M50PT	0.022uF	50V	B
C 1244	K22170817	CHIP CAP.	GRM40B103M50PT	0.01uF	50V	B
C 1245	K22170817	CHIP CAP.	GRM40B103M50PT	0.01uF	50V	B
C 1246	K22170817	CHIP CAP.	GRM40B103M50PT	0.01uF	50V	B
C 1249	K22170817	CHIP CAP.	GRM40B103M50PT	0.01uF	50V	B
C 1250	K46170021	AL. ELECTRO. CAP.	50V100M5X11TR5	10uF	50V	
C 1251	K22170221	CHIP CAP.	GRM40CH270J50PT	27pF	50V	CH
C 1254	K22170219	CHIP CAP.	GRM40CH220J50PT	22pF	50V	CH
C 1256	K22172009	CHIP CAP.	GRM42-6F104Z50PT	0.1uF	50V	F
C 1257	K22172009	CHIP CAP.	GRM42-6F104Z50PT	0.1uF	50V	F
C 1259	K22172009	CHIP CAP.	GRM42-6F104Z50PT	0.1uF	50V	F
C 1260	K22170219	CHIP CAP.	GRM40CH220J50PT	22pF	50V	CH
C 1261	K22170817	CHIP CAP.	GRM40B103M50PT	0.01uF	50V	B
C 1262	K22171008	CHIP CAP.	GRM40F473Z50PT	0.047uF	50V	F
C 1263	K22171008	CHIP CAP.	GRM40F473Z50PT	0.047uF	50V	F
C 1264	K22171008	CHIP CAP.	GRM40F473Z50PT	0.047uF	50V	F
C 1265	K46170021	AL. ELECTRO. CAP.	50V100M5X11TR5	10uF	50V	
C 1266	K22171008	CHIP CAP.	GRM40F473Z50PT	0.047uF	50V	F
C 1267	K46170021	AL. ELECTRO. CAP.	50V100M5X11TR5	10uF	50V	
C 1268	K22171008	CHIP CAP.	GRM40F473Z50PT	0.047uF	50V	F

RF Unit Parts List

ADD	CODE NO	DESCRIPTION	DEVICE	TYP	VAL
C 1269	K22171008	CHIP CAP.	GRM40F473Z50PT	0.047uF	50V F
C 1270	K22171008	CHIP CAP.	GRM40F473Z50PT	0.047uF	50V F
C 1271	K22171008	CHIP CAP.	GRM40F473Z50PT	0.047uF	50V F
C 1272	K22171008	CHIP CAP.	GRM40F473Z50PT	0.047uF	50V F
C 1273	K22171008	CHIP CAP.	GRM40F473Z50PT	0.047uF	50V F
C 1274	K22171008	CHIP CAP.	GRM40F473Z50PT	0.047uF	50V F
C 1275	K22170221	CHIP CAP.	GRM40CH270J50PT	27pF	50V CH
C 1276	K22171008	CHIP CAP.	GRM40F473Z50PT	0.047uF	50V F
C 1277	K22171008	CHIP CAP.	GRM40F473Z50PT	0.047uF	50V F
C 1278	K22170817	CHIP CAP.	GRM40B103M50PT	0.01uF	50V B
D 1001	G2060004	DIODE	1SS270TJ		
D 1002	G2060004	DIODE	1SS270TJ		
D 1003	G2060004	DIODE	1SS270TJ		
D 1004	G2060004	DIODE	1SS270TJ		
D 1005	G2050007	DIODE	1SS83RE		
D 1006	G2050007	DIODE	1SS83RE		
D 1007	G2050007	DIODE	1SS83RE		
D 1008	G2050007	DIODE	1SS83RE		
D 1009	G2050007	DIODE	1SS83RE		
D 1010	G2050007	DIODE	1SS83RE		
D 1011	G2050007	DIODE	1SS83RE		
D 1012	G2050007	DIODE	1SS83RE		
D 1013	G2050007	DIODE	1SS83RE		
D 1014	G2050007	DIODE	1SS83RE		
D 1015	G2050007	DIODE	1SS83RE		
D 1016	G2050007	DIODE	1SS83RE		
D 1017	G2050007	DIODE	1SS83RE		
D 1018	G2050007	DIODE	1SS83RE		
D 1019	G2050007	DIODE	1SS83RE		
D 1020	G2050007	DIODE	1SS83RE		
D 1021	G2050007	DIODE	1SS83RE		
D 1022	G2050007	DIODE	1SS83RE		
D 1023	G2050007	DIODE	1SS83RE		
D 1024	G2050007	DIODE	1SS83RE		
D 1025	G2050007	DIODE	1SS83RE		
D 1026	G2050007	DIODE	1SS83RE		
D 1027	G2050007	DIODE	1SS83RE		
D 1028	G2050007	DIODE	1SS83RE		
D 1029	G2050007	DIODE	1SS83RE		
D 1030	G2050007	DIODE	1SS83RE		
D 1031	G2050007	DIODE	1SS83RE		
D 1032	G2050007	DIODE	1SS83RE		
D 1033	G2050007	DIODE	1SS83RE		
D 1034	G2050007	DIODE	1SS83RE		
D 1035	G2050007	DIODE	1SS83RE		
D 1036	G2050007	DIODE	1SS83RE		
D 1037	G2050007	DIODE	1SS83RE		
D 1038	G2050007	DIODE	1SS83RE		
D 1039	G2050007	DIODE	1SS83RE		
D 1040	G2050007	DIODE	1SS83RE		
D 1041	G2050007	DIODE	1SS83RE		
D 1042	G2050007	DIODE	1SS83RE		
D 1044	G2050008	DIODE	1SS53-TB		
D 1045	G2050008	DIODE	1SS53-TB		
D 1046	G2050008	DIODE	1SS53-TB		
D 1047	G2050008	DIODE	1SS53-TB		
D 1048	G2090457	DIODE	MI204		
D 1049	G2090457	DIODE	MI204		
D 1050	G2060004	DIODE	1SS270TJ		
D 1051	G2060004	DIODE	1SS270TJ		
D 1052	G2060004	DIODE	1SS270TJ		
D 1053	G2060004	DIODE	1SS270TJ		
D 1054	G2060004	DIODE	1SS270TJ		
D 1055	G2060004	DIODE	1SS270TJ		
D 1056	G2060004	DIODE	1SS270TJ		
D 1057	G2060004	DIODE	1SS270TJ		
D 1058	G2090135	DIODE	ND487C2-3R		
D 1059	Q9000375	SURGE ABSORBER	DSP201M-S00B		
D 1060	G2050008	DIODE	1SS53-TB		
D 1061	G2060004	DIODE	1SS270TJ		
D 1062	G2060004	DIODE	1SS270TJ		
D 1063	G2060004	DIODE	1SS270TJ		
FH1001	P2000024	FUSE	UF-0033#01		
J 1001	P0090624	CONNECTOR	SC25-05WS		
J 1002	P0090621	CONNECTOR	SC25-02WS		
J 1003	P0090622	CONNECTOR	SC25-03WS		
J 1004	P0090621	CONNECTOR	SC25-02WS		
J 1005	P1090255	CONNECTOR	TMP-JA		
J 1006	P1090631	CONNECTOR	JPJ2042-01-110		
J 1007	P0090621	CONNECTOR	SC25-02WS		
J 1008	P1090255	CONNECTOR	TMP-JA		
J 1009	P1090255	CONNECTOR	TMP-JA		
J 1010	P0090623	CONNECTOR	SC25-04WS		

For Service Manuals Contact
MAURITRON TECHNICAL SERVICES
 8 Cherry Tree Rd, Chinnor
 Oxon OX9 4QY
 Tel: 01844-351694 Fax: 01844-352554
 Email: enquiries@mauritron.co.uk

RF Unit Parts List

ADD	CODE NO	DESCRIPTION	DEVICE	TYP VAL
J 1011	P1090649	CONNECTOR	TCS5073-59-4151	
J 1013	P1090632	CONNECTOR	JPJ2042-01-120	
J 1014	P0090621	CONNECTOR	SC25-02WS	
J 1015	P0090626	CONNECTOR	SC25-07WS	
J 1016	P1090255	CONNECTOR	TMP-JA	
J 1018	P1090255	CONNECTOR	TMP-JA	
J 1019	P1090255	CONNECTOR	TMP-JA	
J 1020	P1090255	CONNECTOR	TMP-JA	
J 1021	P0090622	CONNECTOR	SC25-03WS	
J 1022	P1090255	CONNECTOR	TMP-JA	
J 1023	P0090621	CONNECTOR	SC25-02WS	
J 1025	P0090623	CONNECTOR	SC25-04WS	
L 1001	L1790164	M.RFC	LAL03VB102K	1mH
L 1002	L1790164	M.RFC	LAL03VB102K	1mH
L 1003	L1790161	M.RFC	LAL03VB561K	560uH
L 1004	L0021222	COIL	0.240U T25-6	
L 1005	L0020927	COIL	0.280U T25-6	
L 1007	L1790064	M.RFC	LAP02TA330K	33uH
L 1008	L1790060	M.RFC	LAP02TA150K	15uH
L 1009	L1790064	M.RFC	LAP02TA330K	33uH
L 1011	L1790164	M.RFC	LAL03VB102K	1mH
L 1012	L1790069	M.RFC	LAP02TA820K	82uH
L 1013	L1790070	M.RFC	LAP02TA101K	100uH
L 1014	L1790069	M.RFC	LAP02TA820K	82uH
L 1015	L1790164	M.RFC	LAL03VB102K	1mH
L 1016	L1790067	M.RFC	LAP02TA560K	56uH
L 1017	L1790063	M.RFC	LAP02TA270K	27uH
L 1018	L1790063	M.RFC	LAP02TA270K	27uH
L 1019	L1790063	M.RFC	LAP02TA270K	27uH
L 1020	L1790067	M.RFC	LAP02TA560K	56uH
L 1021	L1790057	M.RFC	LAP02TA8R2K	8.2uH
L 1022	L1790066	M.RFC	LAP02TA470K	47uH
L 1023	L1790054	M.RFC	LAP02TA4R7K	4.7uH
L 1024	L1790066	M.RFC	LAP02TA470K	47uH
L 1025	L1790057	M.RFC	LAP02TA8R2K	8.2uH
L 1026	L1790057	M.RFC	LAP02TA8R2K	8.2uH
L 1027	L1790064	M.RFC	LAP02TA330K	33uH
L 1028	L1790054	M.RFC	LAP02TA4R7K	4.7uH
L 1029	L1790064	M.RFC	LAP02TA330K	33uH
L 1030	L1790057	M.RFC	LAP02TA8R2K	8.2uH
L 1031	L1790056	M.RFC	LAP02TA6R8K	6.8uH
L 1032	L1790062	M.RFC	LAP02TA220K	22uH
L 1033	L1790052	M.RFC	LAP02TA3R3K	3.3uH
L 1034	L1790062	M.RFC	LAP02TA220K	22uH
L 1035	L1790056	M.RFC	LAP02TA6R8K	6.8uH
L 1036	L1790053	M.RFC	LAP02TA3R9K	3.9uH
L 1037	L1790059	M.RFC	LAP02TA120K	12uH
L 1038	L1790050	M.RFC	LAP02TA2R2K	2.2uH
L 1039	L1790059	M.RFC	LAP02TA120K	12uH
L 1040	L1790053	M.RFC	LAP02TA3R9K	3.9uH
L 1041	L1790049	M.RFC	LAP02TA1R8K	1.8u
L 1042	L1790060	M.RFC	LAP02TA150K	15uH
L 1043	L1790047	M.RFC	LAP02TA1R2K	1.2u
L 1044	L1790060	M.RFC	LAP02TA150K	15uH
L 1045	L1790049	M.RFC	LAP02TA1R8K	1.8u
L 1046	L1790047	M.RFC	LAP02TA1R2K	1.2u
L 1047	L1790058	M.RFC	LAP02TA100K	10uH
L 1048	L1790044	M.RFC	LAP02TA68K	0.68uH
L 1049	L1790058	M.RFC	LAP02TA100K	10uH
L 1050	L1790047	M.RFC	LAP02TA1R2K	1.2u
L 1051	L1790047	M.RFC	LAP02TA1R2K	1.2u
L 1052	L1790058	M.RFC	LAP02TA100K	10uH
L 1053	L1790044	M.RFC	LAP02TA68K	0.68uH
L 1054	L1790058	M.RFC	LAP02TA100K	10uH
L 1055	L1790047	M.RFC	LAP02TA1R2K	1.2u
L 1056	L1790046	M.RFC	LAP02TA1R0K	1uH
L 1057	L1790057	M.RFC	LAP02TA8R2K	8.2uH
L 1058	L1790043	M.RFC	LAP02TA56K	0.56uH
L 1059	L1790057	M.RFC	LAP02TA8R2K	8.2uH
L 1060	L1790046	M.RFC	LAP02TA1R0K	1uH
L 1061	L1790043	M.RFC	LAP02TA56K	0.56uH
L 1062	L1790056	M.RFC	LAP02TA6R8K	6.8uH
L 1063	L1790040	M.RFC	LAP02TA33K	0.33uH
L 1064	L1790056	M.RFC	LAP02TA6R8K	6.8uH
L 1065	L1790043	M.RFC	LAP02TA56K	0.56uH
L 1066	L1790044	M.RFC	LAP02TA68K	0.68uH
L 1067	L1790056	M.RFC	LAP02TA6R8K	6.8uH
L 1068	L1790040	M.RFC	LAP02TA33K	0.33uH
L 1069	L1790056	M.RFC	LAP02TA6R8K	6.8uH
L 1070	L1790044	M.RFC	LAP02TA68K	0.68uH
L 1071	L1790044	M.RFC	LAP02TA68K	0.68uH
L 1072	L1790055	M.RFC	LAP02TA5R6K	5.6uH
L 1073	L1790041	M.RFC	LAP02TA39K	0.39uH

RF Unit Parts List

ADD	CODE NO	DESCRIPTION	DEVICE	TYP VAL
L 1074	L1790055	M.RFC	LAP02TA5R6K	5.6uH
L 1075	L1790044	M.RFC	LAP02TAR68K	0.68uH
L 1076	L1790044	M.RFC	LAP02TAR68K	0.68uH
L 1077	L1790052	M.RFC	LAP02TA3R3K	3.3uH
L 1078	L1790041	M.RFC	LAP02TAR39K	0.39uH
L 1079	L1790052	M.RFC	LAP02TA3R3K	3.3uH
L 1080	L1790044	M.RFC	LAP02TAR68K	0.68uH
L 1081	L1790164	M.RFC	LAL03VB102K	1mH
L 1082	L1790054	M.RFC	LAP02TA4R7K	4.7uH
L 1083	L1790054	M.RFC	LAP02TA4R7K	4.7uH
L 1084	L1790164	M.RFC	LAL03VB102K	1mH
L 1085	L1790164	M.RFC	LAL03VB102K	1mH
L 1086	L0021222	COIL	0.240U T25-6	
L 1087	L0020927	COIL	0.280U T25-6	
L 1088	L1790058	M.RFC	LAP02TA100K	10uH
L 1089	L1790058	M.RFC	LAP02TA100K	10uH
L 1090	L0021815	COIL	6.5T3.0D0.6UEW R	
L 1091	L0021814	COIL	5.5T3.0D0.6UEW R	
L 1093	L1790058	M.RFC	LAP02TA100K	10uH
L 1095	L0020927	COIL	0.280U T25-6	
L 1096	L0021222	COIL	0.240U T25-6	
L 1097	L1790070	M.RFC	LAP02TA101K	100uH
L 1098	L1790052	M.RFC	LAP02TA3R3K	3.3uH
L 1099	L1790070	M.RFC	LAP02TA101K	100uH
L 1100	L1790070	M.RFC	LAP02TA101K	100uH
L 1102	L1790164	M.RFC	LAL03VB102K	1mH
L 1103	L1790058	M.RFC	LAP02TA100K	10uH
L 1106	L1790046	M.RFC	LAP02TA10K	1uH
L 1107	L1790046	M.RFC	LAP02TA10K	1uH
L 1108	L0021820	COIL	5.5T3.5D0.6UEW R	
Q 1001	G1090447	IC	MC14020BCP	
Q 1002	G3070006	TRANSISTOR	FA1A4P-T2B	
Q 1003	G3327127G	TRANSISTOR	2SC2712GR TE85R	
Q 1004	G1090979	IC	UPD74HC238C	
Q 1005	G1090979	IC	UPD74HC238C	
Q 1006	G1090836	IC	M54564P	
Q 1007	G1090836	IC	M54564P	
Q 1008	G3070006	TRANSISTOR	FA1A4P-T2B	
Q 1009	G3801250	FET	2SK125	
Q 1010	G3801250	FET	2SK125	
Q 1011	G3070011	TRANSISTOR	FN1A4P-T2B	
Q 1012	G3070011	TRANSISTOR	FN1A4P-T2B	
Q 1013	G3111627G	TRANSISTOR	2SA1162GR TE85R	
Q 1014	G3327127G	TRANSISTOR	2SC2712GR TE85R	
Q 1015	G3801250	FET	2SK125	
Q 1016	G3801250	FET	2SK125	
Q 1017	G3801250	FET	2SK125	
Q 1018	G3801250	FET	2SK125	
Q 1019	G4800740L	FET	3SK74L	
Q 1020	G3320530	TRANSISTOR	2SC2053	
Q 1021	G3801250	FET	2SK125	
Q 1022	G3320260	TRANSISTOR	2SC2026	
Q 1023	G3327127G	TRANSISTOR	2SC2712GR TE85R	
Q 1024	G3320260	TRANSISTOR	2SC2026	
Q 1025	G3319730	TRANSISTOR	2SC1973	
Q 1026	G3070006	TRANSISTOR	FA1A4P-T2B	
Q 1027	G1090848	IC	UPC78L05J	
Q 1028	G3070006	TRANSISTOR	FA1A4P-T2B	
Q 1029	G3070006	TRANSISTOR	FA1A4P-T2B	
Q 1030	G1090068	IC	MC14011BCP	
Q 1031	G3070011	TRANSISTOR	FN1A4P-T2B	
Q 1032	G3070006	TRANSISTOR	FA1A4P-T2B	
Q 1033	G3803027G	FET	2SK302GR TE85R	
Q 1034	G3803027G	FET	2SK302GR TE85R	
Q 1036	G3801250	FET	2SK125	
Q 1037	G3801250	FET	2SK125	
R 1001	J24205103	CHIP RES.	RMCI/10T 103J	10K 1/10W
R 1002	J24205103	CHIP RES.	RMCI/10T 103J	10K 1/10W
R 1003	J24205472	CHIP RES.	RMCI/10T 472J	4.7K 1/10W
R 1004	J24205223	CHIP RES.	RMCI/10T 223J	22K 1/10W
R 1005	J24205103	CHIP RES.	RMCI/10T 103J	10K 1/10W
R 1006	J24205680	CHIP RES.	RMCI/10T 680J	68 1/10W
R 1007	J24205151	CHIP RES.	RMCI/10T 151J	150 1/10W
R 1008	J24205101	CHIP RES.	RMCI/10T 101J	100 1/10W
R 1009	J24205470	CHIP RES.	RMCI/10T 470J	47 1/10W
R 1010	J24205103	CHIP RES.	RMCI/10T 103J	10K 1/10W
R 1011	J24205101	CHIP RES.	RMCI/10T 101J	100 1/10W
R 1012	J24205103	CHIP RES.	RMCI/10T 103J	10K 1/10W
R 1013	J24205222	CHIP RES.	RMCI/10T 222J	2.2K 1/10W
R 1014	J24205102	CHIP RES.	RMCI/10T 102J	1K 1/10W
R 1015	J01245331	CARBON FILM RES.	RD14TJ331 330	330 1/4W
R 1016	J24205330	CHIP RES.	RMCI/10T 330J	33 1/10W
R 1017	J24205101	CHIP RES.	RMCI/10T 101J	100 1/10W

For Service Manuals Contact
MAURITRON TECHNICAL SERVICES
 8 Cherry Tree Rd, Chinnor
 Oxon OX9 4QY
 Tel: 01844-351694 Fax: 01844-352554
 Email: enquiries@maurifron.co.uk

RF Unit Parts List

ADD	CODE NO	DESCRIPTION	DEVICE		TYP	VAL
R 1018	J24205151	CHIP RES.	RMC1/10T 151J	150		1/10W
R 1019	J24205101	CHIP RES.	RMC1/10T 101J	100		1/10W
R 1020	J24205330	CHIP RES.	RMC1/10T 330J	33		1/10W
R 1021	J24205101	CHIP RES.	RMC1/10T 101J	100		1/10W
R 1022	J24205330	CHIP RES.	RMC1/10T 330J	33		1/10W
R 1023	J24205101	CHIP RES.	RMC1/10T 101J	100		1/10W
R 1024	J24205330	CHIP RES.	RMC1/10T 330J	33		1/10W
R 1025	J24205101	CHIP RES.	RMC1/10T 101J	100		1/10W
R 1026	J24205330	CHIP RES.	RMC1/10T 330J	33		1/10W
R 1027	J24205101	CHIP RES.	RMC1/10T 101J	100		1/10W
R 1028	J24205330	CHIP RES.	RMC1/10T 330J	33		1/10W
R 1029	J24205101	CHIP RES.	RMC1/10T 101J	100		1/10W
R 1030	J24205330	CHIP RES.	RMC1/10T 330J	33		1/10W
R 1031	J24205101	CHIP RES.	RMC1/10T 101J	100		1/10W
R 1032	J24205330	CHIP RES.	RMC1/10T 330J	33		1/10W
R 1033	J24205101	CHIP RES.	RMC1/10T 101J	100		1/10W
R 1034	J24205330	CHIP RES.	RMC1/10T 330J	33		1/10W
R 1035	J24205101	CHIP RES.	RMC1/10T 101J	100		1/10W
R 1036	J24205330	CHIP RES.	RMC1/10T 330J	33		1/10W
R 1037	J24205101	CHIP RES.	RMC1/10T 101J	100		1/10W
R 1038	J24205330	CHIP RES.	RMC1/10T 330J	33		1/10W
R 1039	J24205101	CHIP RES.	RMC1/10T 101J	100		1/10W
R 1040	J24205330	CHIP RES.	RMC1/10T 330J	33		1/10W
R 1041	J24205101	CHIP RES.	RMC1/10T 101J	100		1/10W
R 1042	J24205330	CHIP RES.	RMC1/10T 330J	33		1/10W
R 1043	J24205101	CHIP RES.	RMC1/10T 101J	100		1/10W
R 1044	J24205330	CHIP RES.	RMC1/10T 330J	33		1/10W
R 1045	J24205101	CHIP RES.	RMC1/10T 101J	100		1/10W
R 1046	J01245221	CARBON FILM RES.	RD14TJ221 220	220		1/4W
R 1047	J24205471	CHIP RES.	RMC1/10T 471J	470		1/10W
R 1048	J24205391	CHIP RES.	RMC1/10T 391J	390		1/10W
R 1049	J07225220	CARBON FILM RES.	RD16TPJ220 22	22		1/6W
R 1050	J24205150	CHIP RES.	RMC1/10T 150J	15		1/10W
R 1051	J24205221	CHIP RES.	RMC1/10T 221J	220		1/10W
R 1052	J24205471	CHIP RES.	RMC1/10T 471J	470		1/10W
R 1053	J24205101	CHIP RES.	RMC1/10T 101J	100		1/10W
R 1054	J24205101	CHIP RES.	RMC1/10T 101J	100		1/10W
R 1055	J24205103	CHIP RES.	RMC1/10T 103J	10K		1/10W
R 1056	J24205103	CHIP RES.	RMC1/10T 103J	10K		1/10W
R 1057	J24205103	CHIP RES.	RMC1/10T 103J	10K		1/10W
R 1058	J24205470	CHIP RES.	RMC1/10T 470J	47		1/10W
R 1059	J24205223	CHIP RES.	RMC1/10T 223J	22K		1/10W
R 1060	J24205332	CHIP RES.	RMC1/10T 332J	3.3K		1/10W
R 1061	J24205103	CHIP RES.	RMC1/10T 103J	10K		1/10W
R 1062	J24205222	CHIP RES.	RMC1/10T 222J	2.2K		1/10W
R 1063	J24205470	CHIP RES.	RMC1/10T 470J	47		1/10W
R 1064	J24205681	CHIP RES.	RMC1/10T 681J	680		1/10W
R 1065	J24205681	CHIP RES.	RMC1/10T 681J	680		1/10W
R 1066	J24205681	CHIP RES.	RMC1/10T 681J	680		1/10W
R 1067	J24205681	CHIP RES.	RMC1/10T 681J	680		1/10W
R 1068	J07225150	CARBON FILM RES.	RD16TPJ150 15	15		1/6W
R 1069	J24205473	CHIP RES.	RMC1/10T 473J	47K		1/10W
R 1070	J24205183	CHIP RES.	RMC1/10T 183J	18K		1/10W
R 1071	J24205104	CHIP RES.	RMC1/10T 104J	100K		1/10W
R 1072	J24205152	CHIP RES.	RMC1/10T 152J	1.5K		1/10W
R 1073	J24205104	CHIP RES.	RMC1/10T 104J	100K		1/10W
R 1074	J24205103	CHIP RES.	RMC1/10T 103J	10K		1/10W
R 1075	J24205101	CHIP RES.	RMC1/10T 101J	100		1/10W
R 1076	J24205681	CHIP RES.	RMC1/10T 681J	680		1/10W
R 1077	J24205471	CHIP RES.	RMC1/10T 471J	470		1/10W
R 1078	J24205479	CHIP RES.	RMC1/10T 477J	4.7		1/10W
R 1079	J02245101	CARBON FILM RES.	RD14SJ101 100	100		1/4W
R 1083	J24205181	CHIP RES.	RMC1/10T 181J	180		1/10W
R 1084	J24205103	CHIP RES.	RMC1/10T 103J	10K		1/10W
R 1085	J24205104	CHIP RES.	RMC1/10T 104J	100K		1/10W
R 1086	J24205104	CHIP RES.	RMC1/10T 104J	100K		1/10W
R 1087	J24205470	CHIP RES.	RMC1/10T 470J	47		1/10W
R 1088	J24205101	CHIP RES.	RMC1/10T 101J	100		1/10W
R 1089	J24205104	CHIP RES.	RMC1/10T 104J	100K		1/10W
R 1090	J24205104	CHIP RES.	RMC1/10T 104J	100K		1/10W
R 1091	J24205101	CHIP RES.	RMC1/10T 101J	100		1/10W
R 1092	J24205100	CHIP RES.	RMC1/10T 100J	10		1/10W
R 1093	J24205151	CHIP RES.	RMC1/10T 151J	150		1/10W
R 1094	J24205100	CHIP RES.	RMC1/10T 100J	10		1/10W
R 1095	J24205100	CHIP RES.	RMC1/10T 100J	10		1/10W
R 1096	J24205151	CHIP RES.	RMC1/10T 151J	150		1/10W
R 1097	J24205100	CHIP RES.	RMC1/10T 100J	10		1/10W
R 1099	J24205471	CHIP RES.	RMC1/10T 471J	470		1/10W
R 1100	J24205332	CHIP RES.	RMC1/10T 332J	3.3K		1/10W
R 1101	J24205102	CHIP RES.	RMC1/10T 102J	1K		1/10W
R 1102	J24205151	CHIP RES.	RMC1/10T 151J	150		1/10W
R 1103	J24205222	CHIP RES.	RMC1/10T 222J	2.2K		1/10W
R 1104	J24205470	CHIP RES.	RMC1/10T 470J	47		1/10W

RF Unit Parts List

ADD	CODE NO	DESCRIPTION	DEVICE	TYP VAL
R 1105	J24205472	CHIP RES.	RMC1/10T 472J	4.7K 1/10W
R 1106	J24205470	CHIP RES.	RMC1/10T 470J	47 1/10W
R 1107	J24205561	CHIP RES.	RMC1/10T 561J	560 1/10W
R 1108	J24205223	CHIP RES.	RMC1/10T 223J	22K 1/10W
R 1110	J00275221	CARBON FILM RES.	RD12VJ221 220	220 1/2W
R 1111	J24205222	CHIP RES.	RMC1/10T 222J	2.2K 1/10W
R 1112	J24205560	CHIP RES.	RMC1/10T 560J	56 1/10W
R 1113	J24205102	CHIP RES.	RMC1/10T 102J	1K 1/10W
R 1114	J24205102	CHIP RES.	RMC1/10T 102J	1K 1/10W
R 1115	J24205102	CHIP RES.	RMC1/10T 102J	1K 1/10W
R 1116	J24205102	CHIP RES.	RMC1/10T 102J	1K 1/10W
R 1117	J24205103	CHIP RES.	RMC1/10T 103J	10K 1/10W
R 1118	J24205103	CHIP RES.	RMC1/10T 103J	10K 1/10W
R 1119	J24205682	CHIP RES.	RMC1/10T 682J	6.8K 1/10W
R 1120	J24205103	CHIP RES.	RMC1/10T 103J	10K 1/10W
R 1121	J24205103	CHIP RES.	RMC1/10T 103J	10K 1/10W
R 1122	J24205103	CHIP RES.	RMC1/10T 103J	10K 1/10W
R 1123	J24205103	CHIP RES.	RMC1/10T 103J	10K 1/10W
R 1124	J24205000	CHIP RES.	RMC1/10T 000J	0 1/10W
R 1125	J24205104	CHIP RES.	RMC1/10T 104J	100K 1/10W
R 1126	J24205470	CHIP RES.	RMC1/10T 470J	47 1/10W
R 1127	J24205103	CHIP RES.	RMC1/10T 103J	10K 1/10W
R 1128	J24205470	CHIP RES.	RMC1/10T 470J	47 1/10W
R 1129	J24205000	CHIP RES.	RMC1/10T 000J	0 1/10W
R 1130	J24205104	CHIP RES.	RMC1/10T 104J	100K 1/10W
R 1131	J24205103	CHIP RES.	RMC1/10T 103J	10K 1/10W
R 1132	J24205101	CHIP RES.	RMC1/10T 101J	100 1/10W
R 1133	J24205000	CHIP RES.	RMC1/10T 000J	0 1/10W
R 1135	J24205221	CHIP RES.	RMC1/10T 221J	220 1/10W
R 1136	J24205220	CHIP RES.	RMC1/10T 220J	22 1/10W
R 1137	J24205221	CHIP RES.	RMC1/10T-221J	220 1/10W
R 1138	J24205330	CHIP RES.	RMC1/10T 330J	33 1/10W
R 1139	J24205471	CHIP RES.	RMC1/10T 471J	470 1/10W
R 1140	J24205471	CHIP RES.	RMC1/10T 471J	470 1/10W
R 1141	J24205560	CHIP RES.	RMC1/10T 560J	56 1/10W
R 1142	J24205222	CHIP RES.	RMC1/10T 222J	2.2K 1/10W
R 1143	J24205102	CHIP RES.	RMC1/10T 102J	1K 1/10W
R 1144	J24205222	CHIP RES.	RMC1/10T 222J	2.2K 1/10W
R 1145	J24205222	CHIP RES.	RMC1/10T 222J	2.2K 1/10W
R 1146	J24205471	CHIP RES.	RMC1/10T 471J	470 1/10W
R 1147	J24205473	CHIP RES.	RMC1/10T 473J	47K 1/10W
R 1148	J24205102	CHIP RES.	RMC1/10T 102J	1K 1/10W
R 1149	J24205153	CHIP RES.	RMC1/10T 153J	15K 1/10W
R 1150	J24205102	CHIP RES.	RMC1/10T 102J	1K 1/10W
R 1151	J24205102	CHIP RES.	RMC1/10T 102J	1K 1/10W
R 1152	J24205560	CHIP RES.	RMC1/10T 560J	56 1/10W
R 1153	J24205103	CHIP RES.	RMC1/10T 103J	10K 1/10W
R 1154	J24205680	CHIP RES.	RMC1/10T 680J	68 1/10W
R 1155	J24205100	CHIP RES.	RMC1/10T 100J	10 1/10W
R 1156	J24205100	CHIP RES.	RMC1/10T 100J	10 1/10W
R 1157	J24205151	CHIP RES.	RMC1/10T 151J	150 1/10W
R 1158	J24205105	CHIP RES.	RMC1/10T 105J	1M 1/10W
R 1159	J24205105	CHIP RES.	RMC1/10T 105J	1M 1/10W
RL1001	M1190090	RELAY	AG4013 DC12V	DC12V
RL1002	M1190090	RELAY	AG4013 DC12V	DC12V
RL1003	M1190090	RELAY	AG4013 DC12V	DC12V
RL1004	M1190090	RELAY	AG4013 DC12V	DC12V
RL1005	M1190045	RELAY	AG2013 DC12V	DC12V
S 1001	N6090066	SLIDE SWITCH	SS912L4NS	
S 1002	N6090066	SLIDE SWITCH	SS912L4NS	
T 1001	L0021484	COIL		
T 1003	L0020883	COIL	4-1 2001F	
T 1004	L0020883	COIL	4-1 2001F	
T 1005	L0021974	COIL	- 2001F	
T 1006	L0021973	COIL	- 2001F	
T 1007	L0021605	COIL	9-1 2001F	
T 1008	L0021959	COIL		
T 1009	L0020788A	COIL	4-1 2D3 TR6X3	
T 1010	L0021957	COIL	73.62M R12-J757A	
T 1011	L0021960	COIL	73.62M S-135-214	
T 1012	L0021960	COIL	73.62M S-135-214	
T 1013	L0021960	COIL	73.62M S-135-214	
T 1014	L0021957	COIL	73.62M R12-J757A	
T 1017	L0020788A	COIL	4-1 2D3 TR6X3	
T 1018	L0021462	07 WIDE TRANS 4:1 3A	4-1 3A	
T 1020	L0021958	COIL	R12-J758A	
T 1021	L0021957	COIL	73.62M R12-J757A	
T 1022	L0020788A	COIL	4-1 2D3 TR6X3	
T 1023	L0020788A	COIL	4-1 2D3 TR6X3	
T 1027	L0021484	COIL		
T 1028	L0021484	COIL		
TH1001	G9090008	THERMISTOR	112102-2	
TP1002	Q5000082	TP-N IPS-1091	TP-N IPS-1091	

For Service Manuals Contact
MAURITRON TECHNICAL SERVICES
 8 Cherry Tree Rd, Chinnor
 Oxon OX9 4QY
 Tel: 01844-351694 Fax: 01844-352554
 Email: enquiries@mauritron.co.uk

RF Unit Parts List

ADD	CODE NO	DESCRIPTION	DEVICE	TYP	VAL
TP1003	Q5000082	TP-N IPS-1091	TP-N IPS-1091		
TP1004	Q5000082	TP-N IPS-1091	TP-N IPS-1091		
VR1001	J51745332	POT.	H0651A010-3.3KB		3.3KB
VR1002	J51745472	POT.	H0651A011-4.7KB		4.7KB
VR1003	J51745472	POT.	H0651A011-4.7KB		4.7KB
XF1001	H1102150	XTAL	73M12BU		
XF1002	H1102150	XTAL	73M12BU		

For Service Manuals Contact
MAURITRON TECHNICAL SERVICES
8 Cherry Tree Rd, Chinnor
Oxon OX9 4QY
Tel: 01844-351694 Fax: 01844-352554
Email: enquiries@mauriron.co.uk

Notes

For Service Manuals Contact
MAURITRON TECHNICAL SERVICES
8 Cherry Tree Rd, Chinnor
Oxon OX9 4QY
Tel: 01844-351694 Fax: 01844-352554
Email: enquiries@mauritron.co.uk

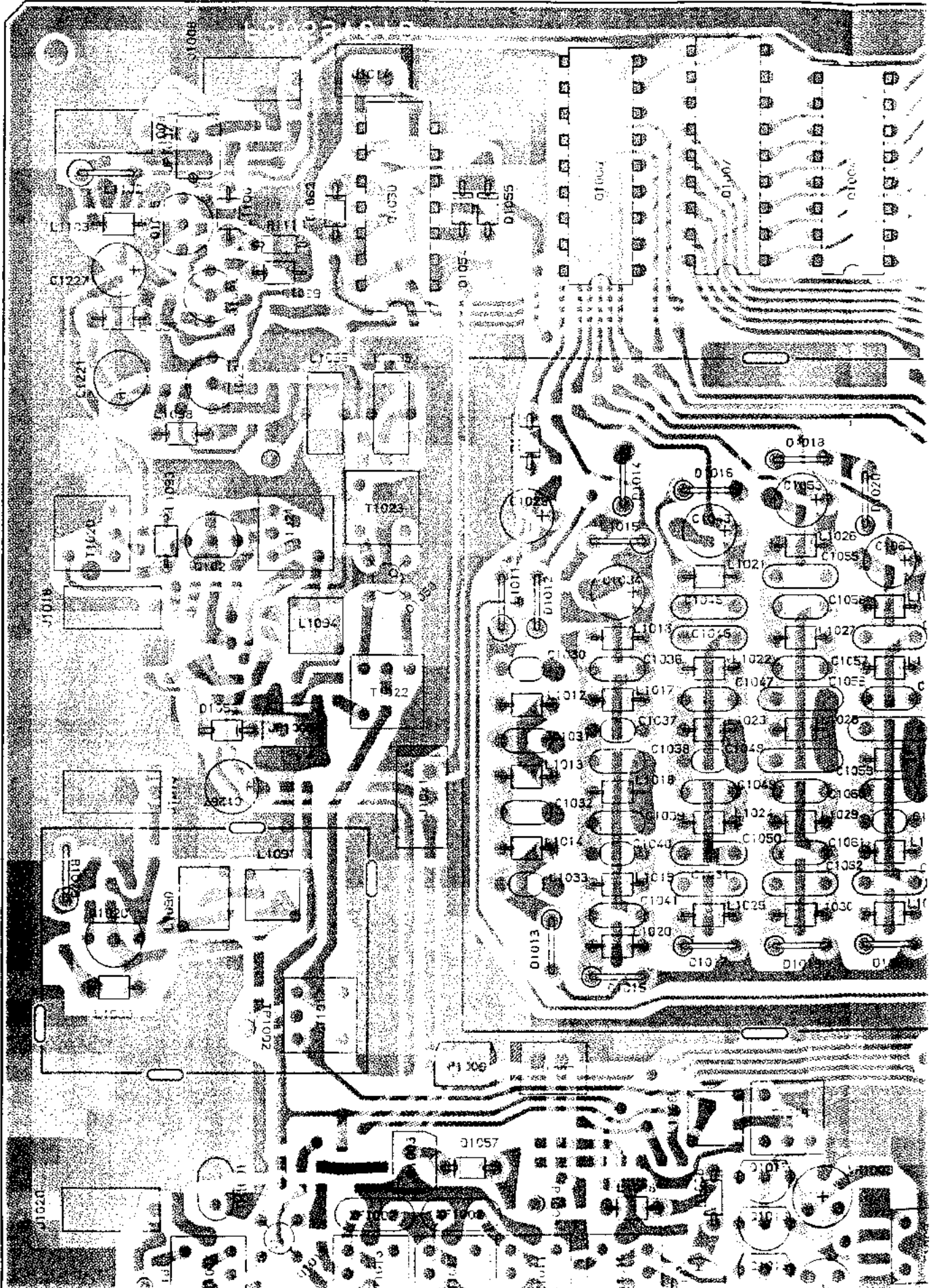

MAURITRON TECHNICAL SERVICES
8 Cherry Tree Rd, Chinnor
Oxon OX9 4QY
Tel: 01844-351694 Fax: 01844-352554
Email: enquiries@mauritron.co.uk

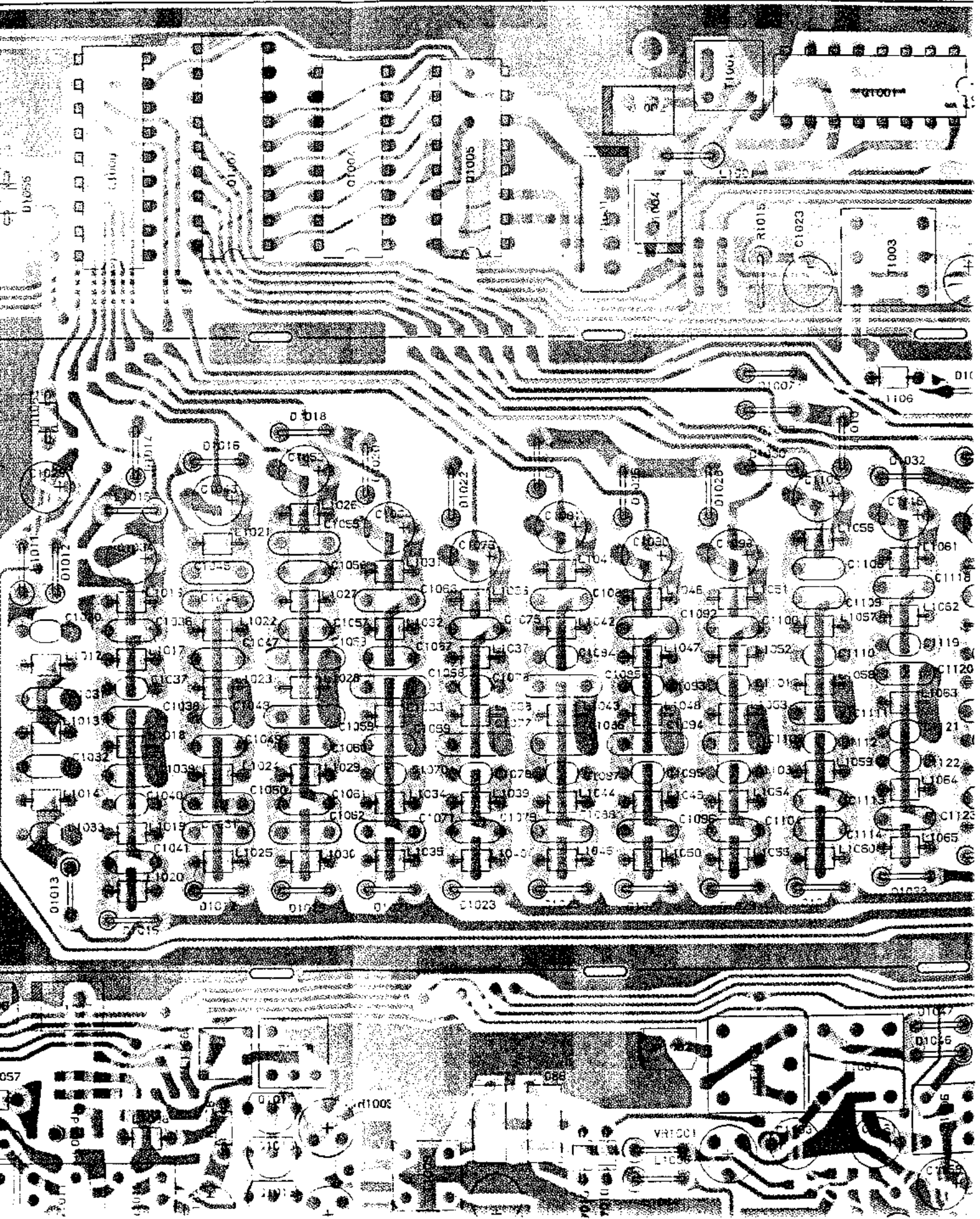

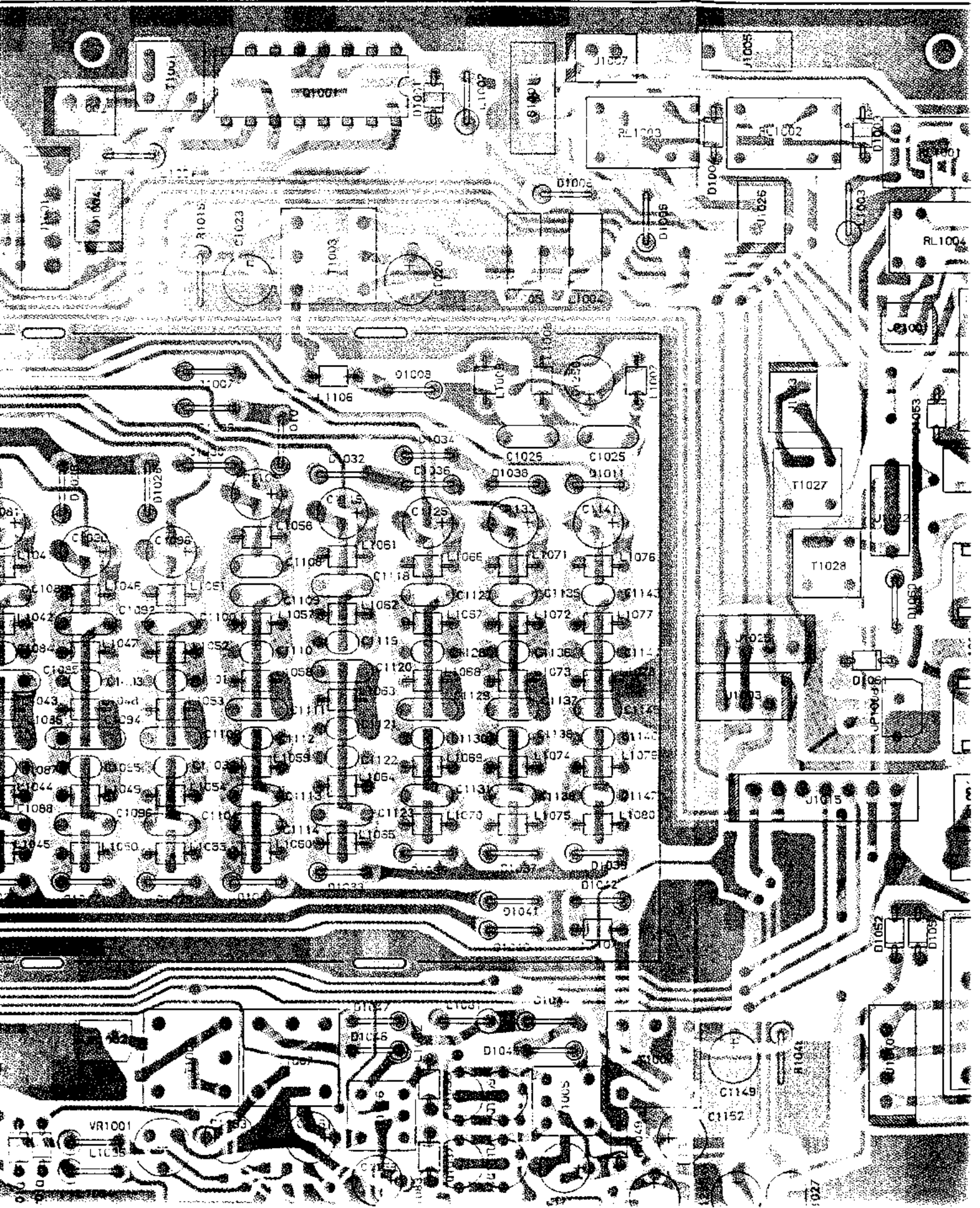

RF Unit Layout

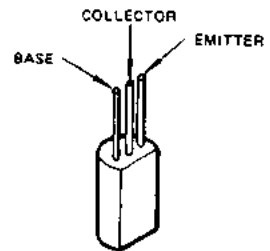
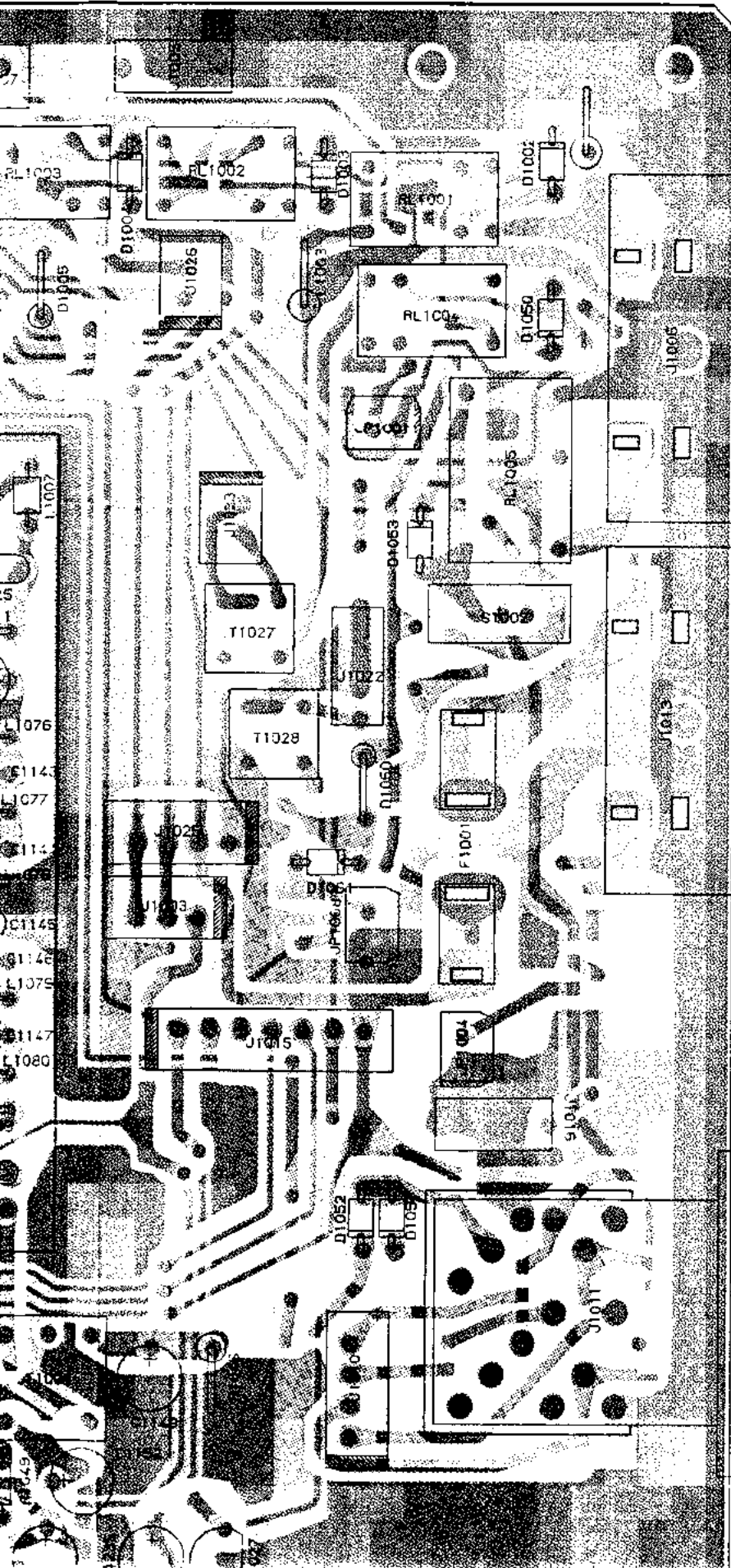

2SC1973
(Q1025)

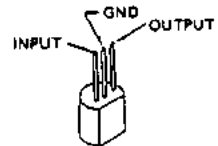

MFC78L05J
(Q1027)

For Service Manuals Contact
MAURITRON TECHNICAL SERVICES
 8 Cherry Tree Rd, Chinnor
 Oxon OX9 4QY
 Tel: 01844 351694 Fax: 01844 352554
 Email: enquiries@mauritron.co.uk

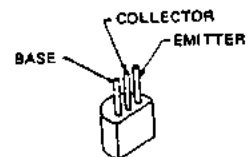

2SC2026
(Q1022, Q1024)

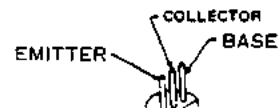

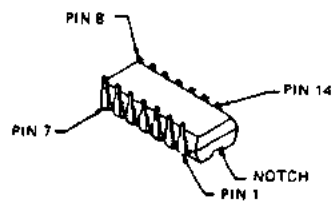
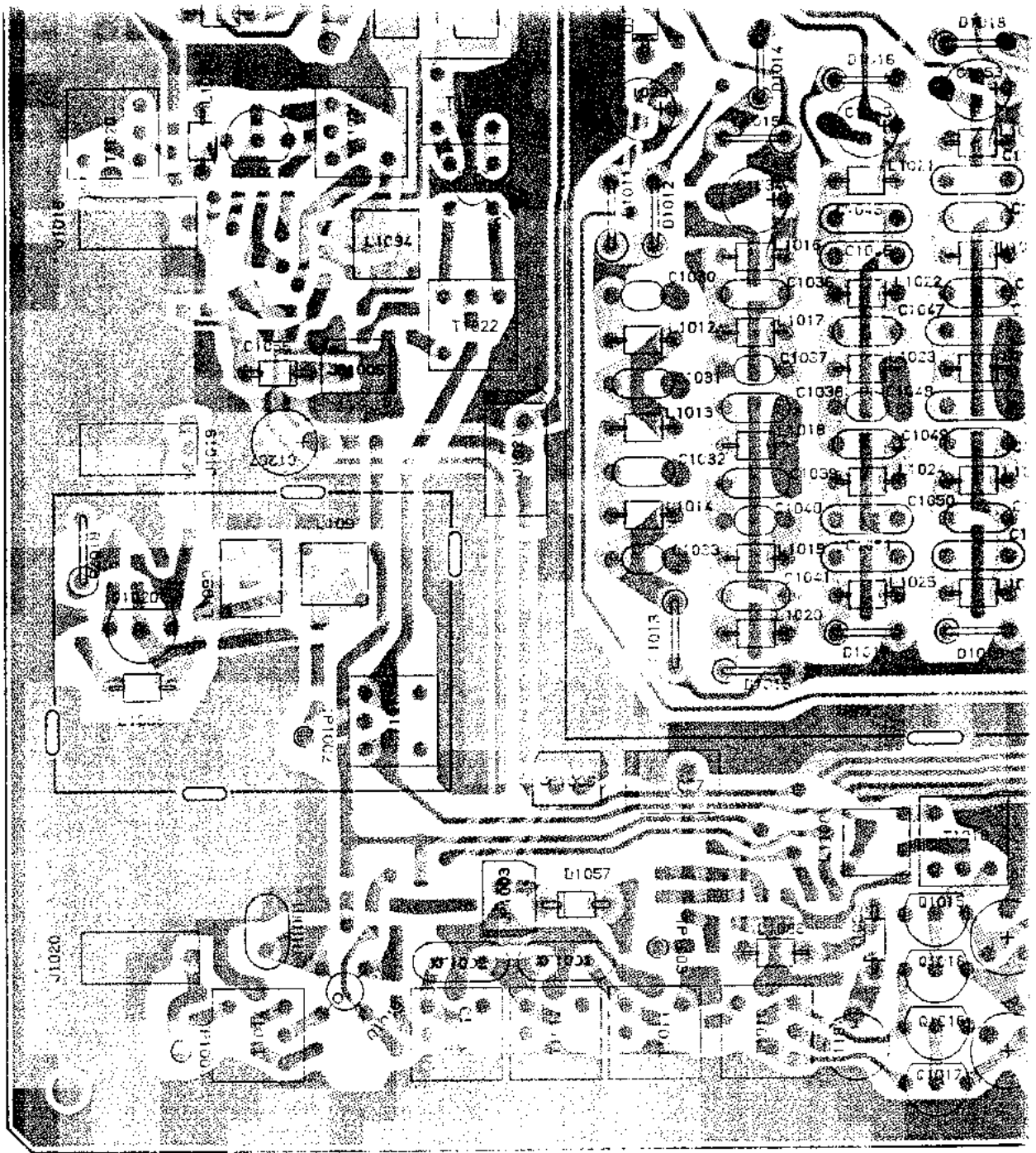

MC14011BCP
(Q1030)

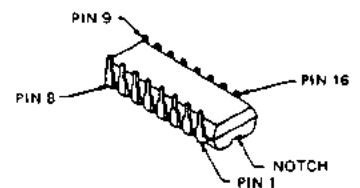

MC14020BCP
(Q1001)
μPD74HC238C
(Q1004, Q1005)

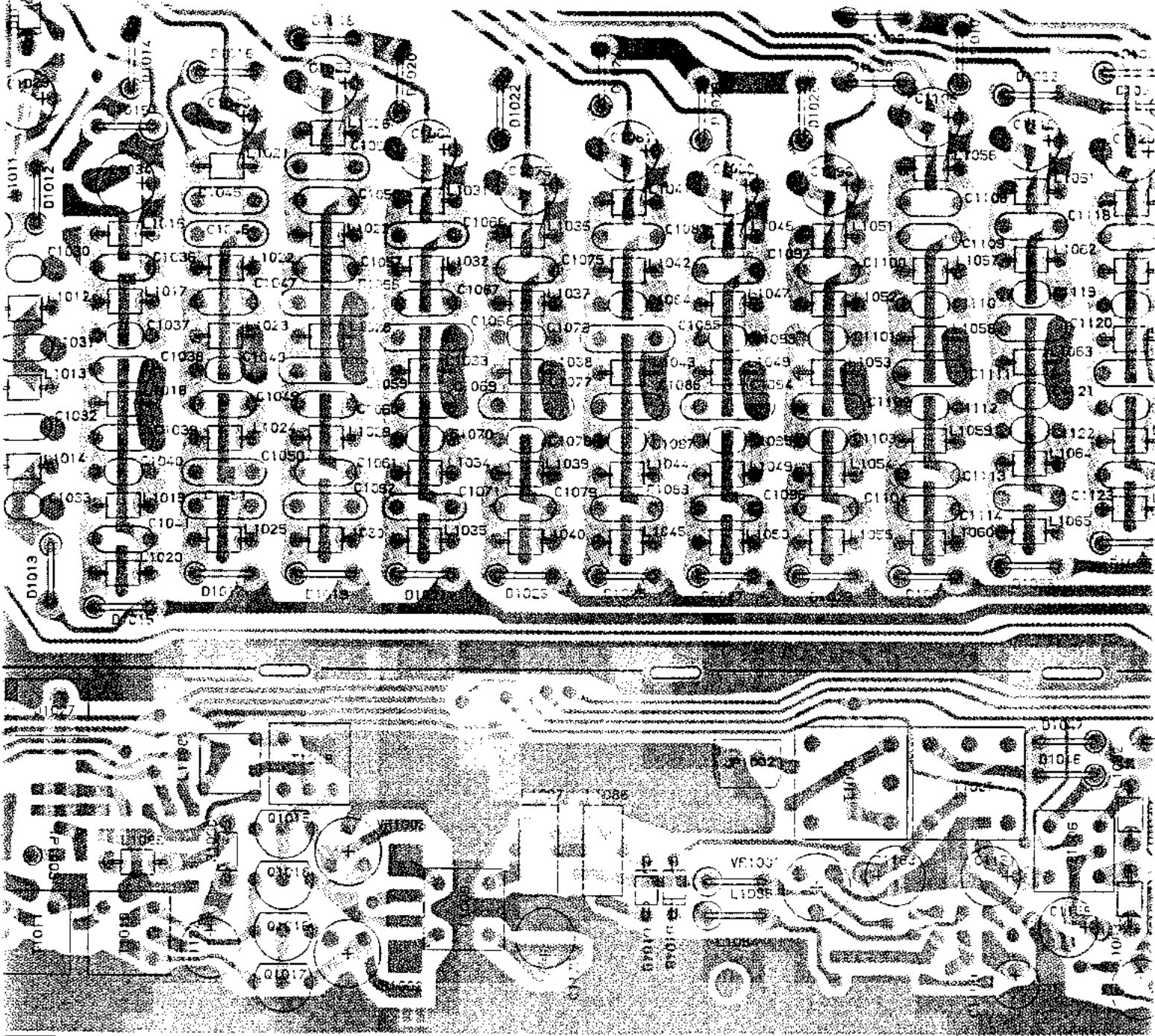

For Service Manuals Contact
MAURITRON TECHNICAL SERVICES
 8 Cherry Tree Rd, Chinnor
 Oxon OX9 4QY
 Tel: 01844-351694 Fax: 01844-352554
 Email: enquiries@maurtron.co.uk

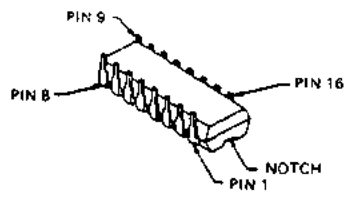

MC14020BCP
 (Q1001)
 μPD74HC238C
 (Q1004, Q1005)

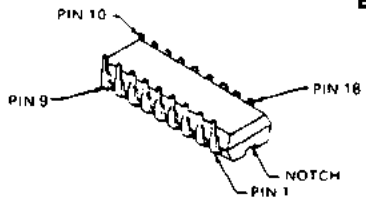

M54564P
 (Q1006, Q1007)

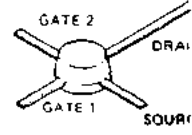

3SK74L
 (Q1019)

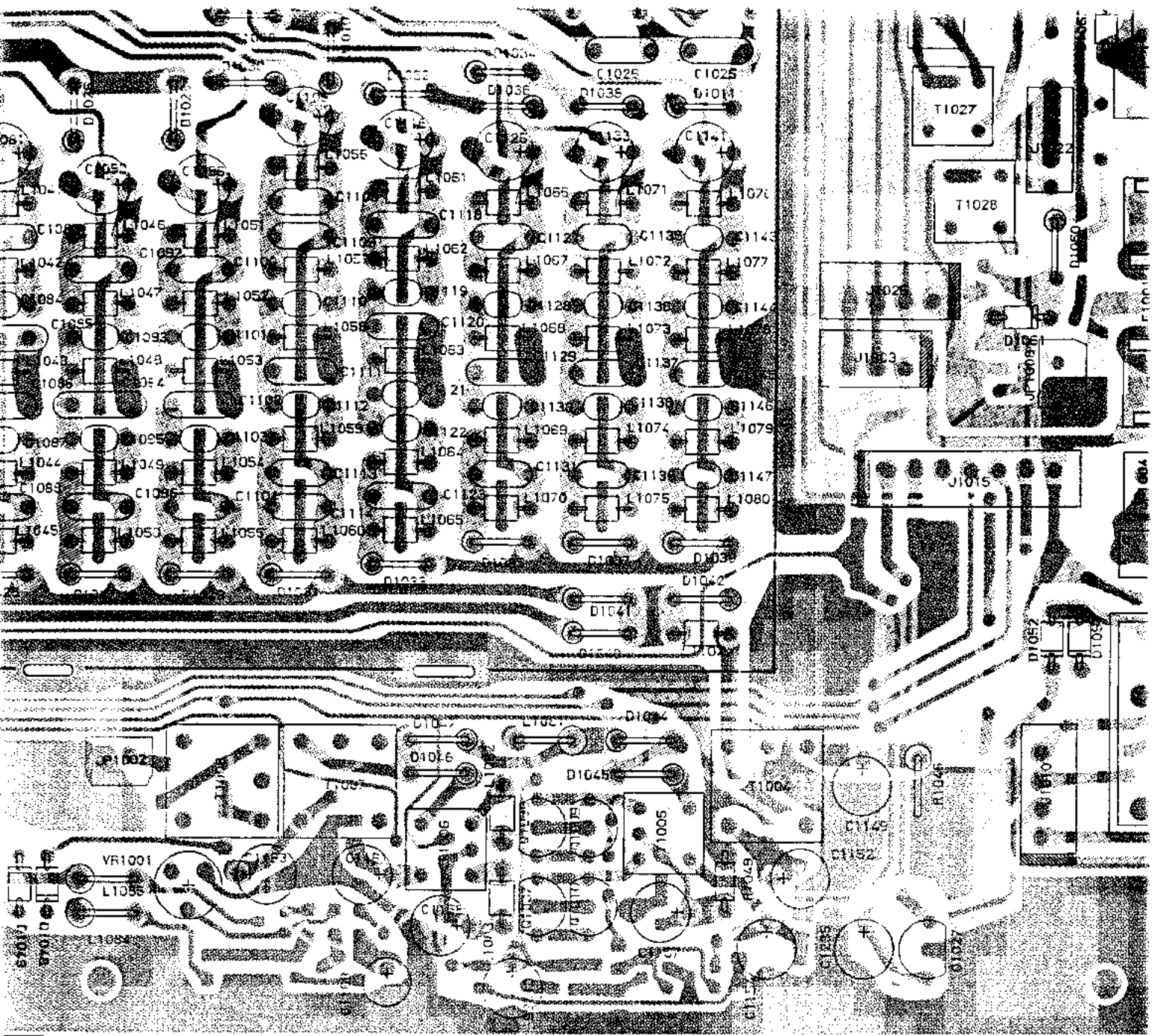

(obverse view of "c

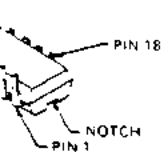

Q1007)

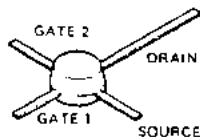

3SK74L
(Q1019)

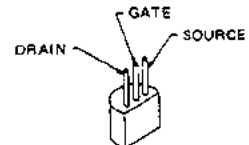

2SK125
(Q1009, Q1010, Q1015,
Q1016, Q1017, Q1018,
Q1021, Q1036, Q1037)

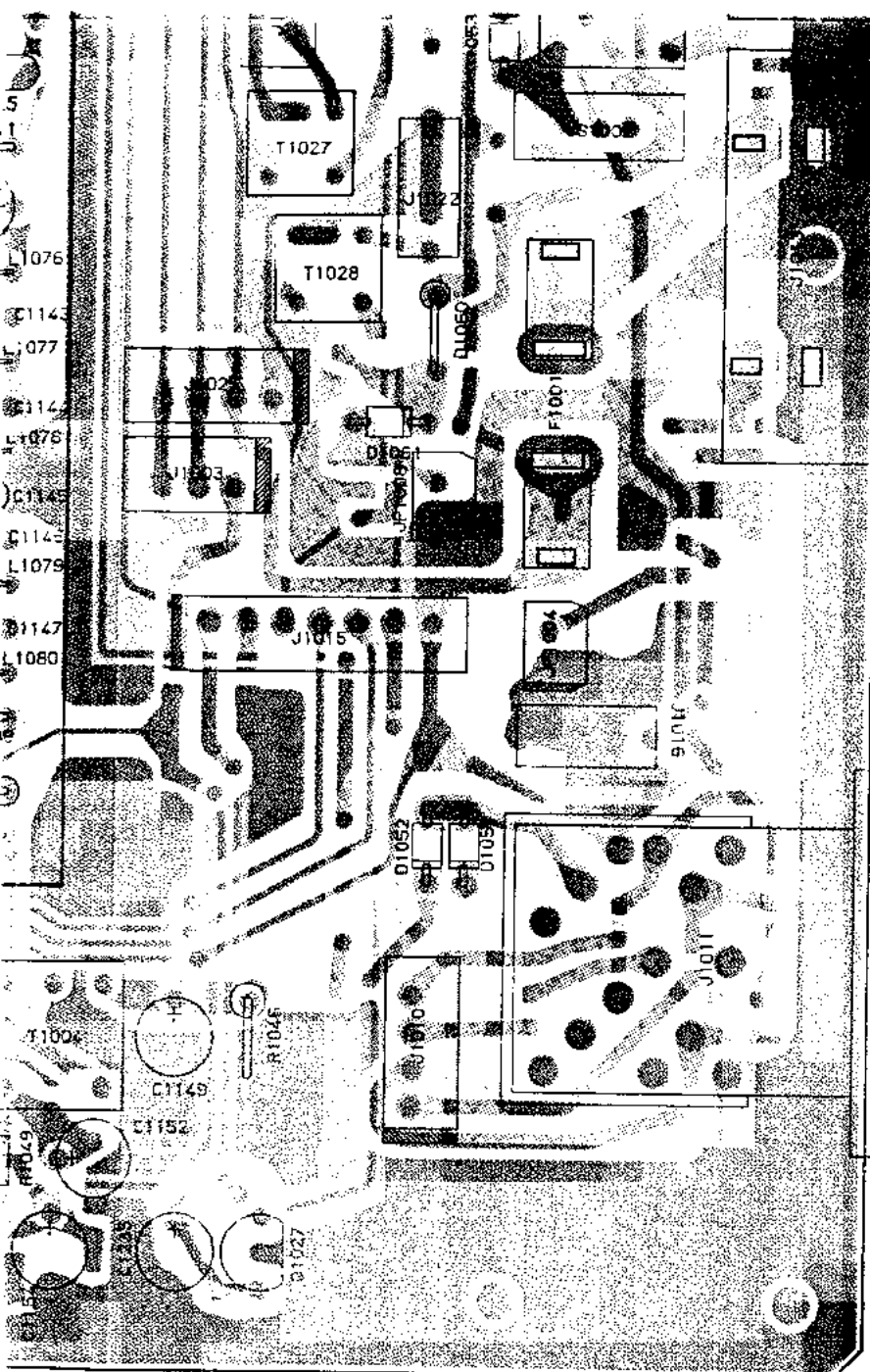

(obverse view of "component" side)

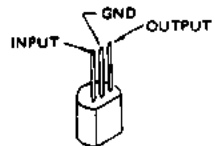

μPC78L05J
(Q1027)

For Service Manuals Contact
MAURITRON TECHNICAL SERVICES
 8 Cherry Tree Rd, Chinnor
 Oxon OX9 4QY
 Tel: 01844-351694 Fax: 01844-352554
 Email: enquires@mauritron.co.uk

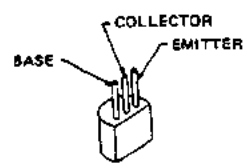

2SC2026
(Q1022, Q1024)

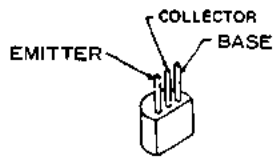

2SC2053
(Q1020)

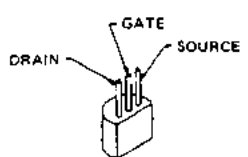

2SK125
 (Q1009, Q1010, Q1015,
 Q1016, Q1017, Q1018,
 Q1021, Q1036, Q1037)

For Service Manuals Contact
8 Cherry Tree Rd, Chinnor
Oxon OX9 4QY
Tel: 01844-351694 Fax: 01844-352554
Email: enquiries@maunitron.co.uk

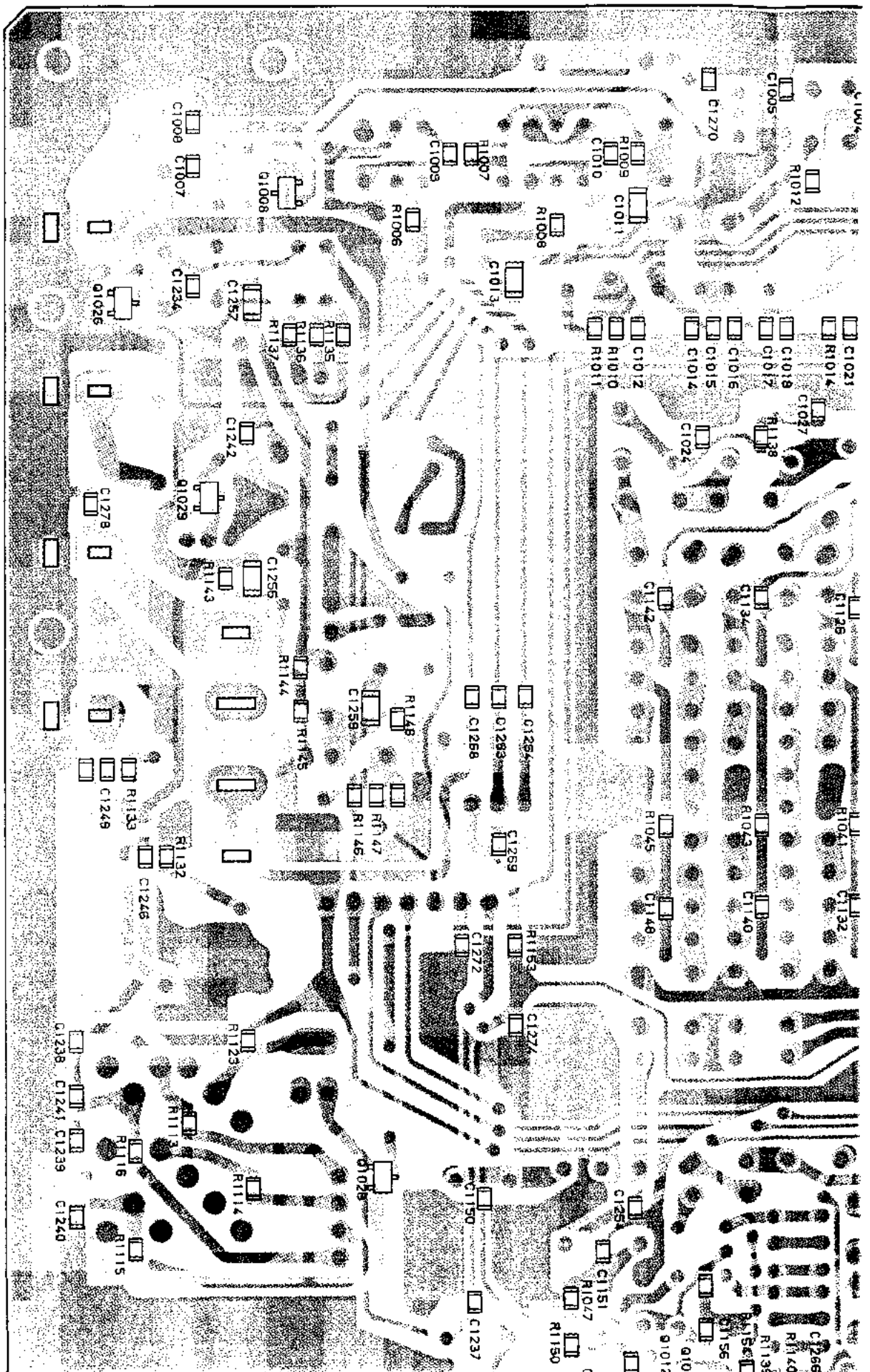

For Service Manuals Contact
MAURITRON TECHNICAL SERVICES

8 Cherry Tree Rd, Chinnor
Oxon OX9 4QY

Tel: 01844-351894 Fax: 01844-352554

Email: enquiries@mauritron.co.uk

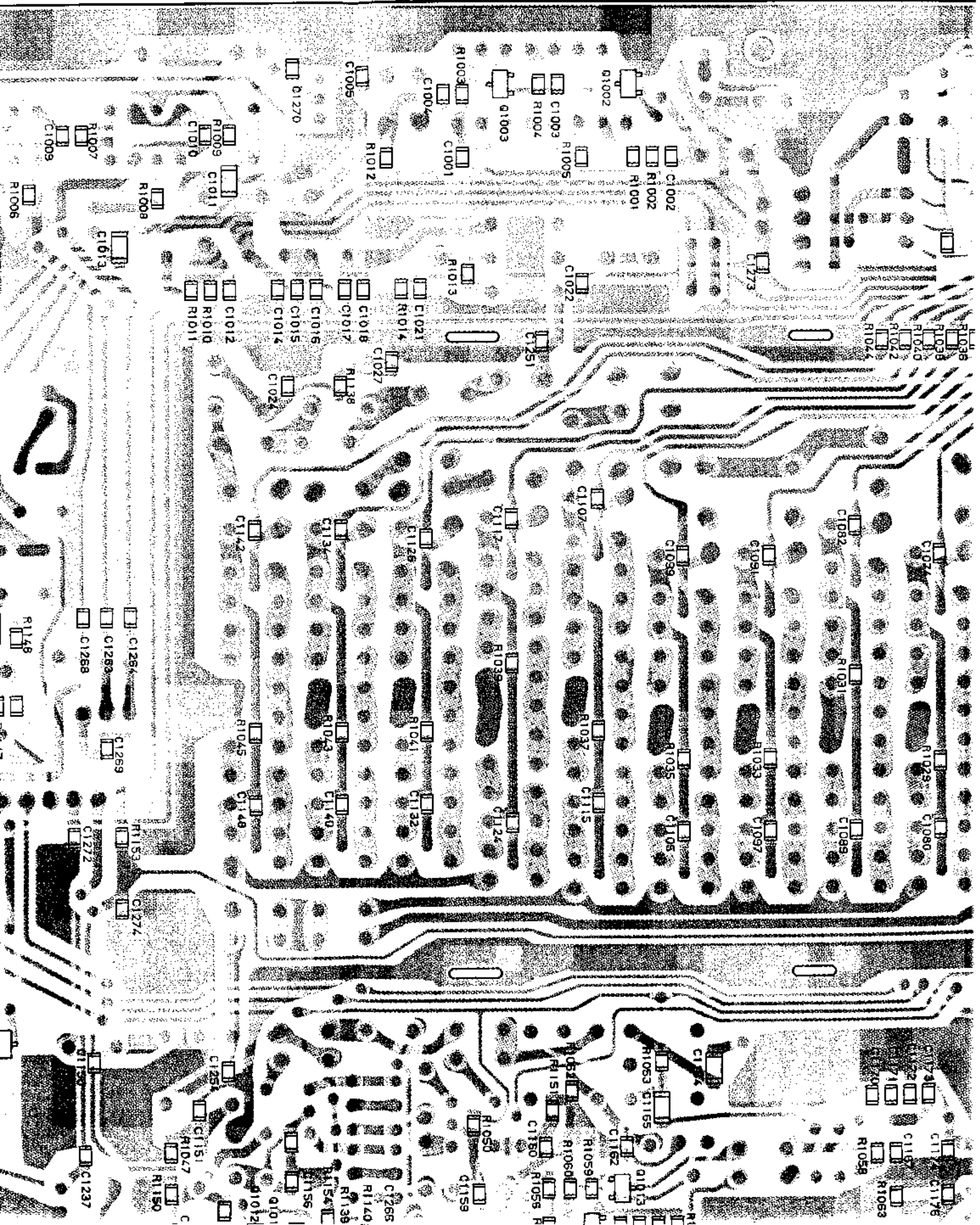

RF Unit Layout

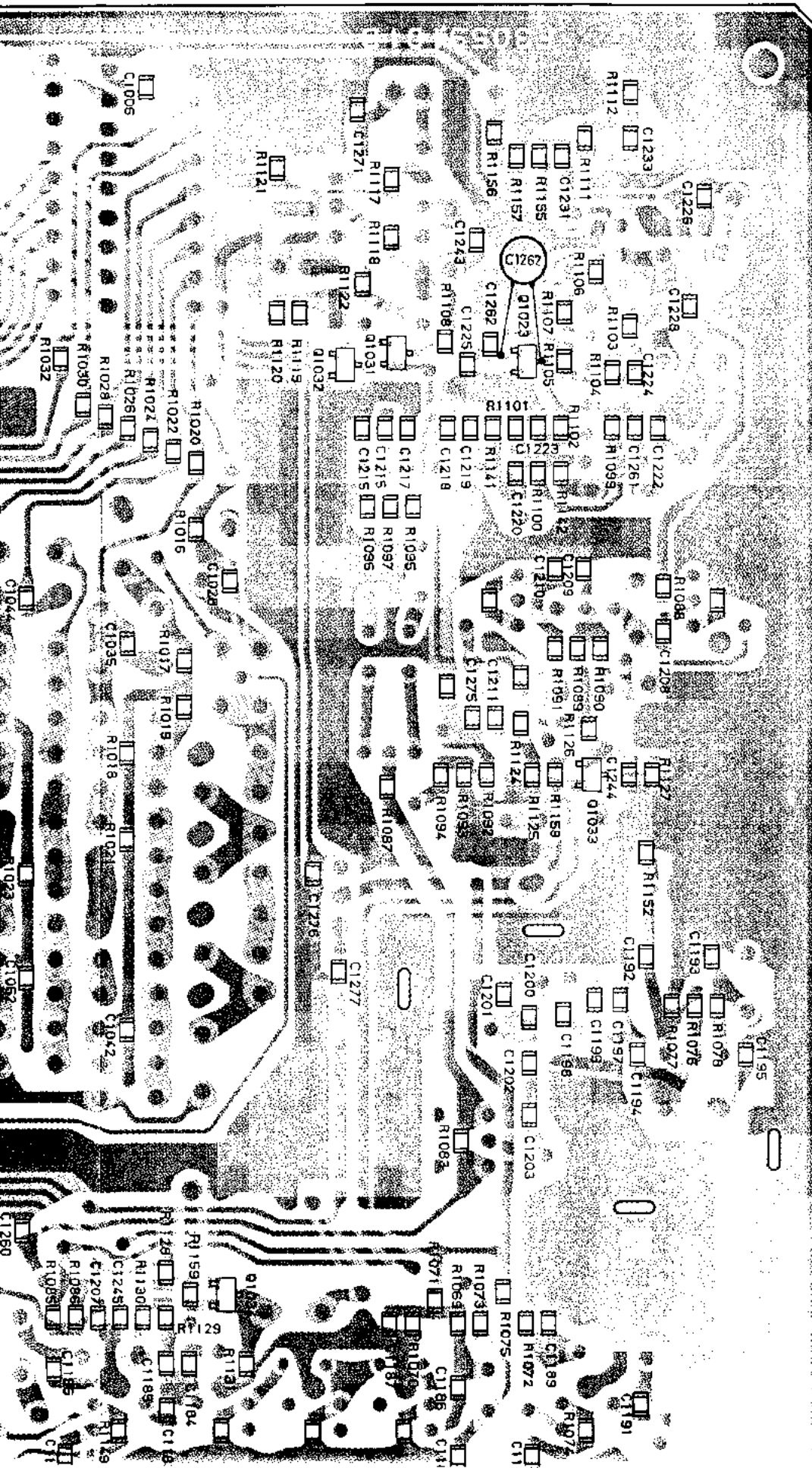

For Service Manuals Contact
MAURITRON TECHNICAL SERVICES
8 Cherry Tree Rd, Chinnor
Oxon OX9 4QY
Tel: 01844-351694 Fax: 01844-352554
Email: enquiries@mauritron.co.uk

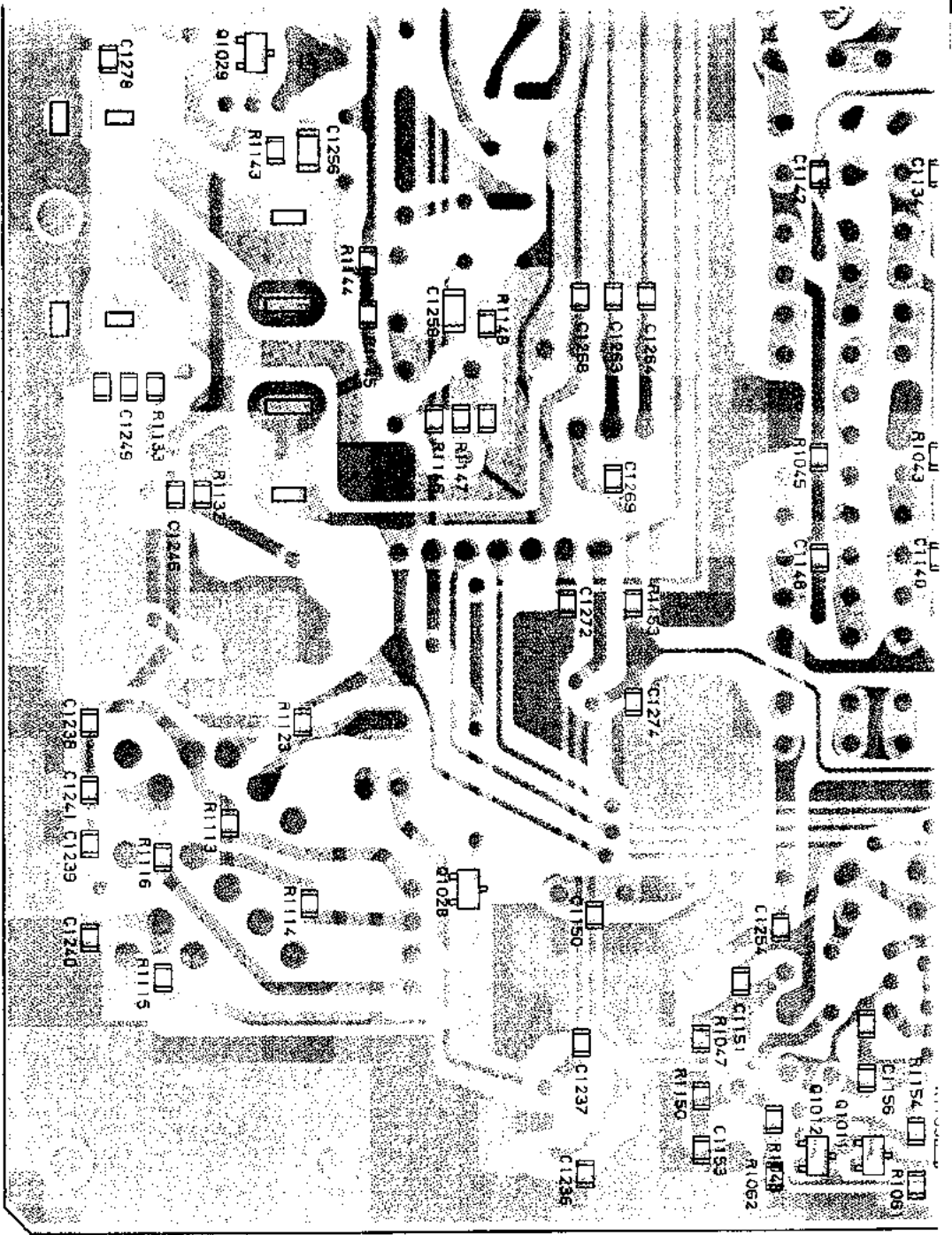

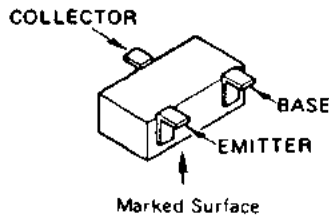
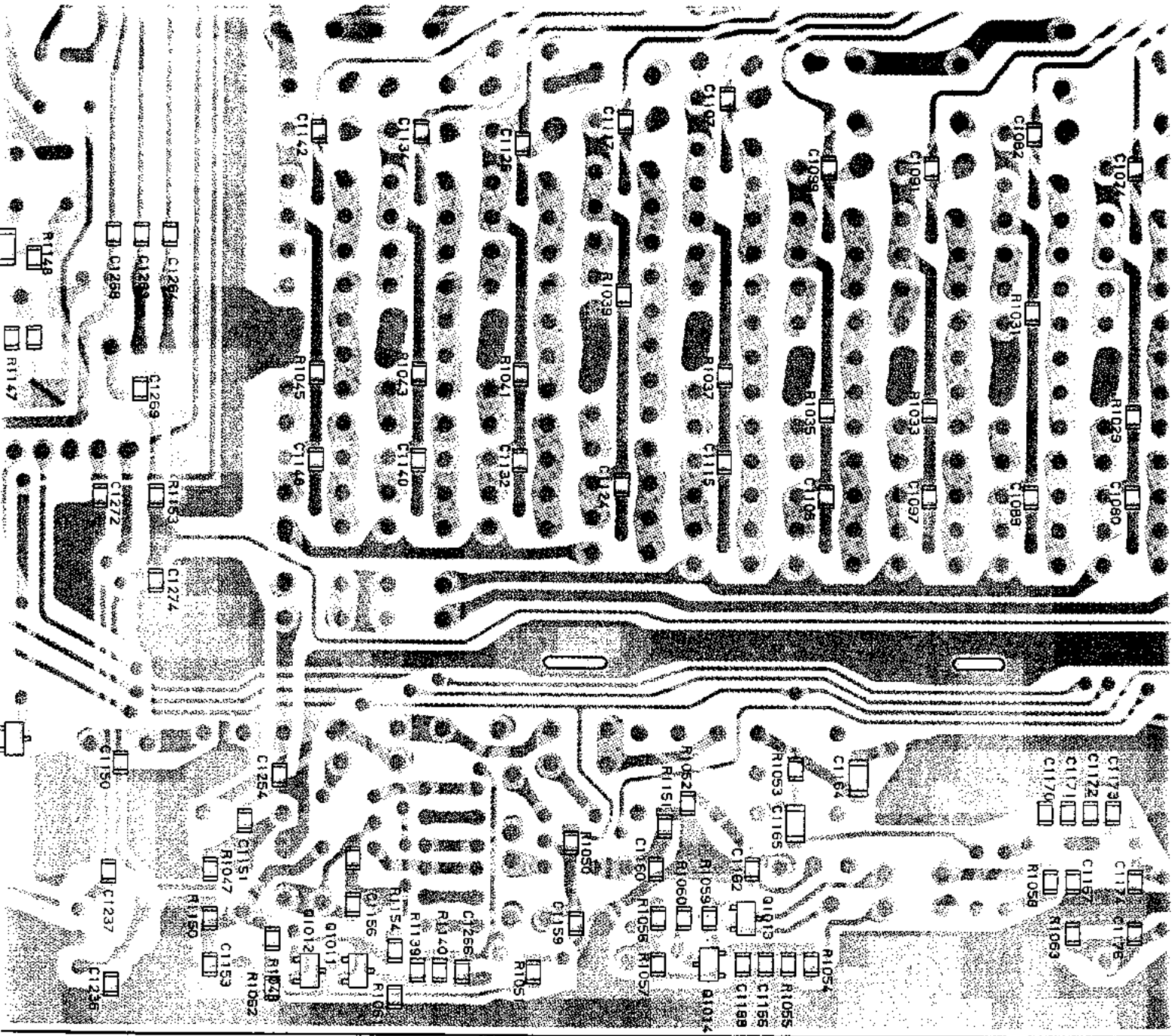

For Service Manuals Contact
MAURITRON TECHNICAL SERVICES
 8 Cherry Tree Rd, Chinnor
 Oxon OX9 4QY
 Tel: 01844-351634 Fax: 01844-352554
 Email: enquiries@mauritron.co.uk

SOURCE

- FA1A4P(L34)
 (Q1002, Q1008, Q1026,
 Q1028, Q1029, Q1032)
- FN1A4P(M34)
 (Q1011, Q1012, Q1031)
- 2SA1162GR(SG)
 (Q1013)
- 2SC2712GR(LG)
 (Q1003, Q1014, Q1023)

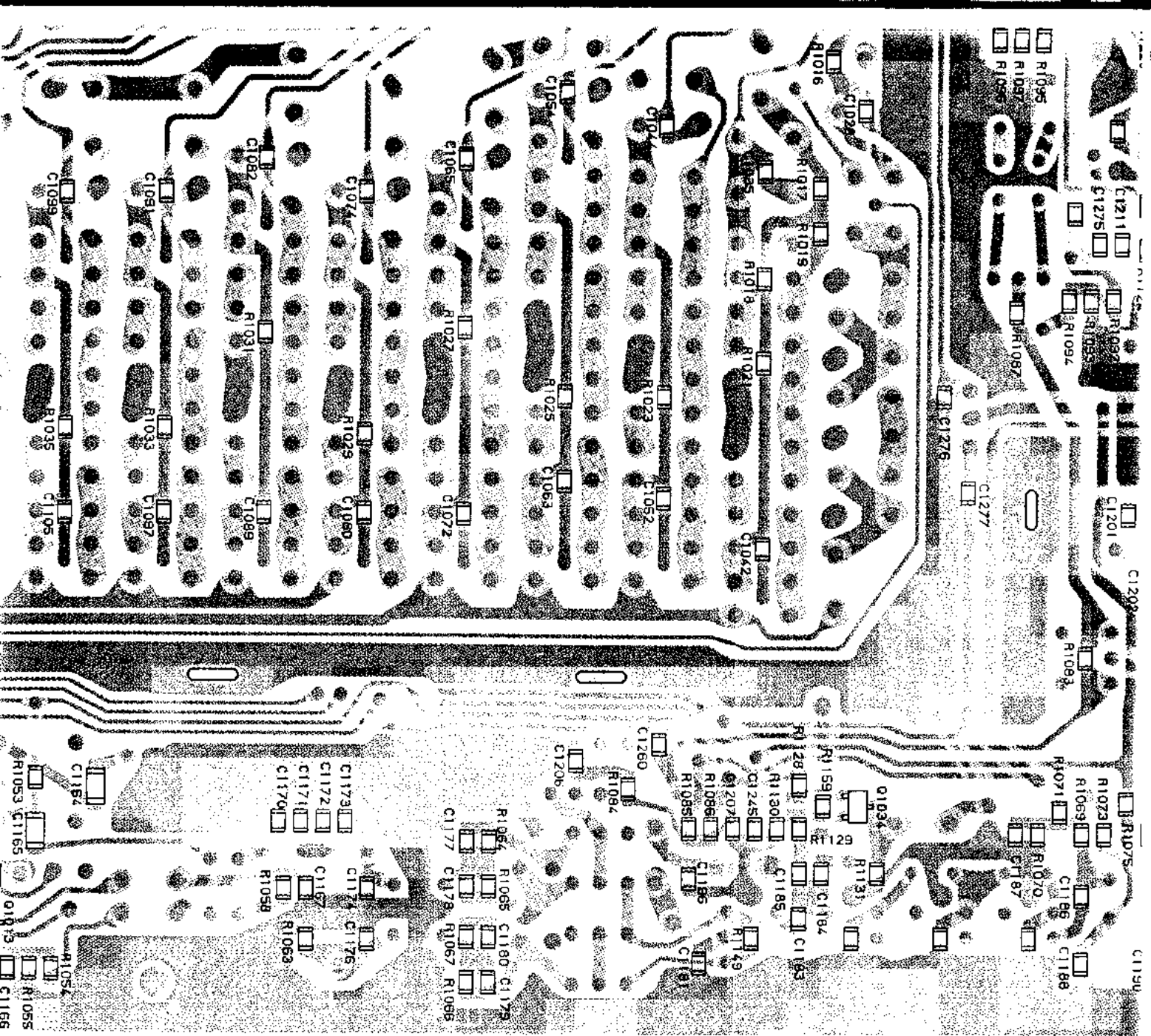

(obverse view)

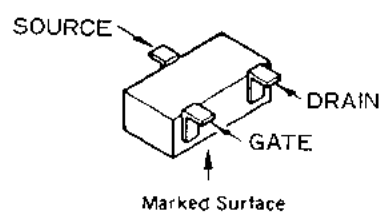

2SK302GR (TGR)
(Q1033, Q1034)

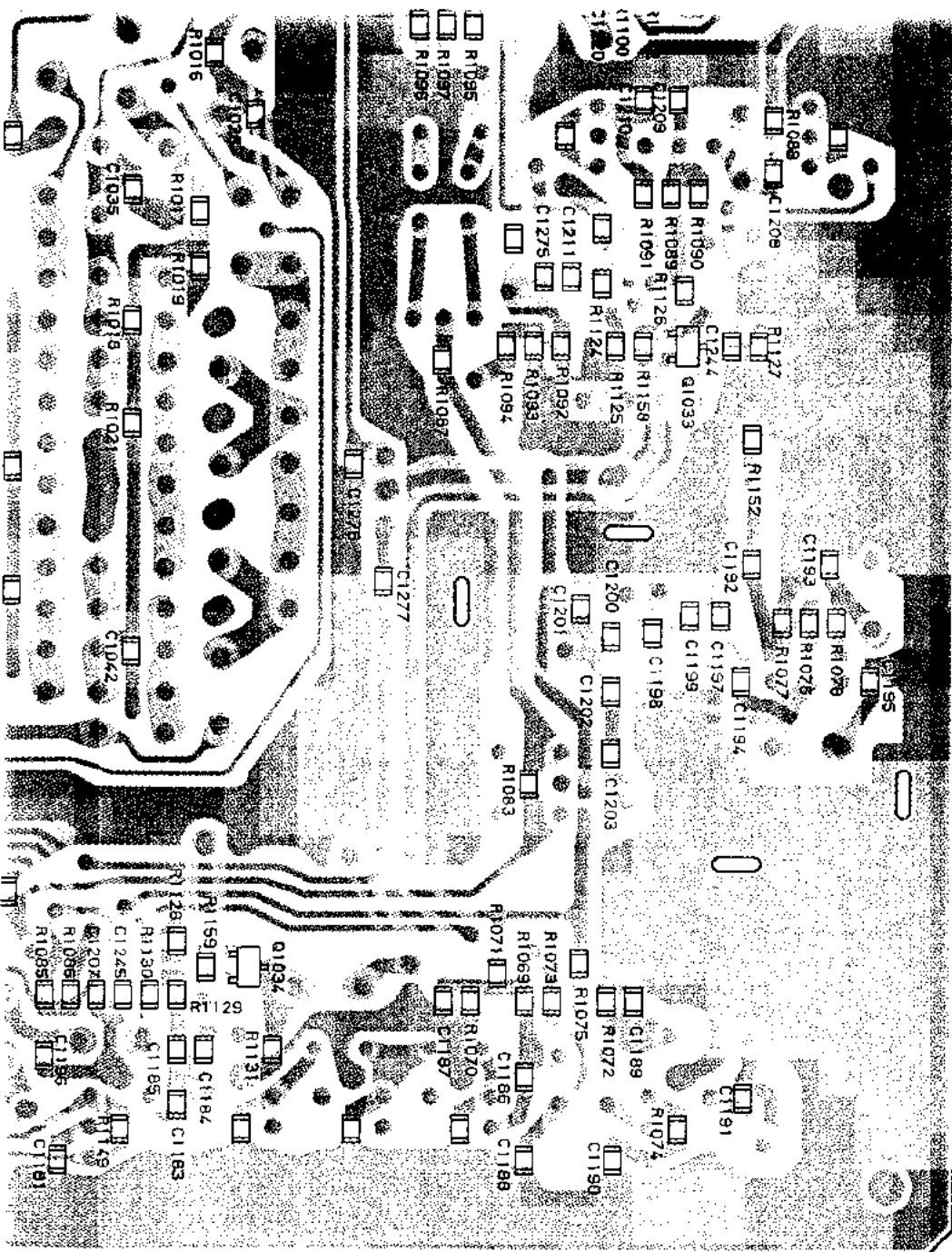

For Service Manuals Contact
MAURITRON TECHNICAL SERVICES
 8 Cherry Tree Rd, Chinnor
 Oxon OX9 4QY
 Tel: 01844-351694 Fax: 01844-352554
 Email: enquires@mauritron.co.uk

(obverse view of "chip-only" side)

For Service Manuals Contact
MAURITRON TECHNICAL SERVICES
B Cherry Tree Rd, Chinnor
Oxon OX9 4QY
Tel: 01844-351694 Fax: 01844-352554
Email: enquiries@mauritron.co.uk

RF UNIT
F3059101B

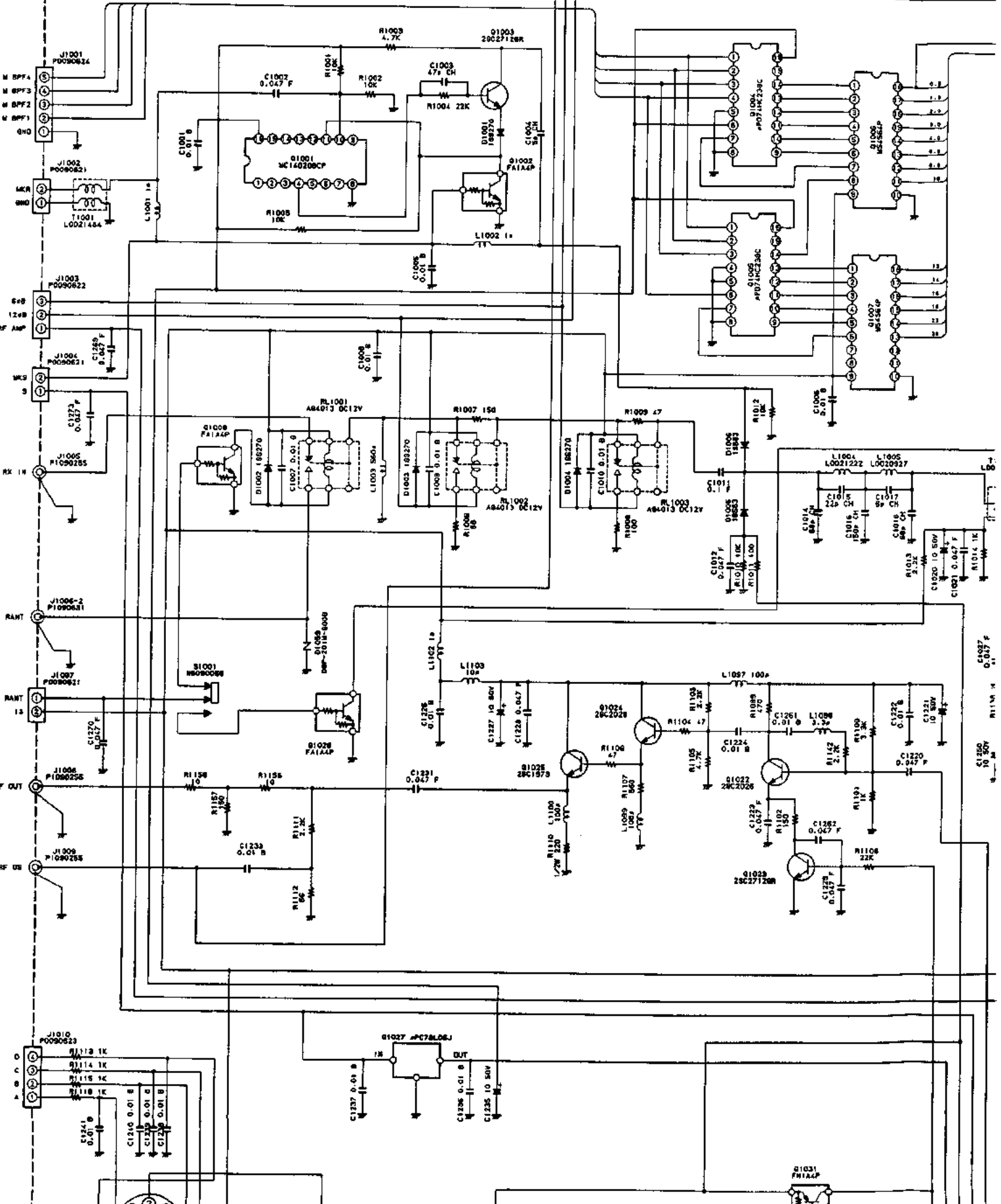

For Service Manuals Contact
MAURITRON TECHNICAL SERVICES
8 Cherry Tree Rd, Chinnor
Oxon OX9 4QY

Tel: 01844 351694 Fax: 01844 352554

Email: enquiries@mauritron.co.uk

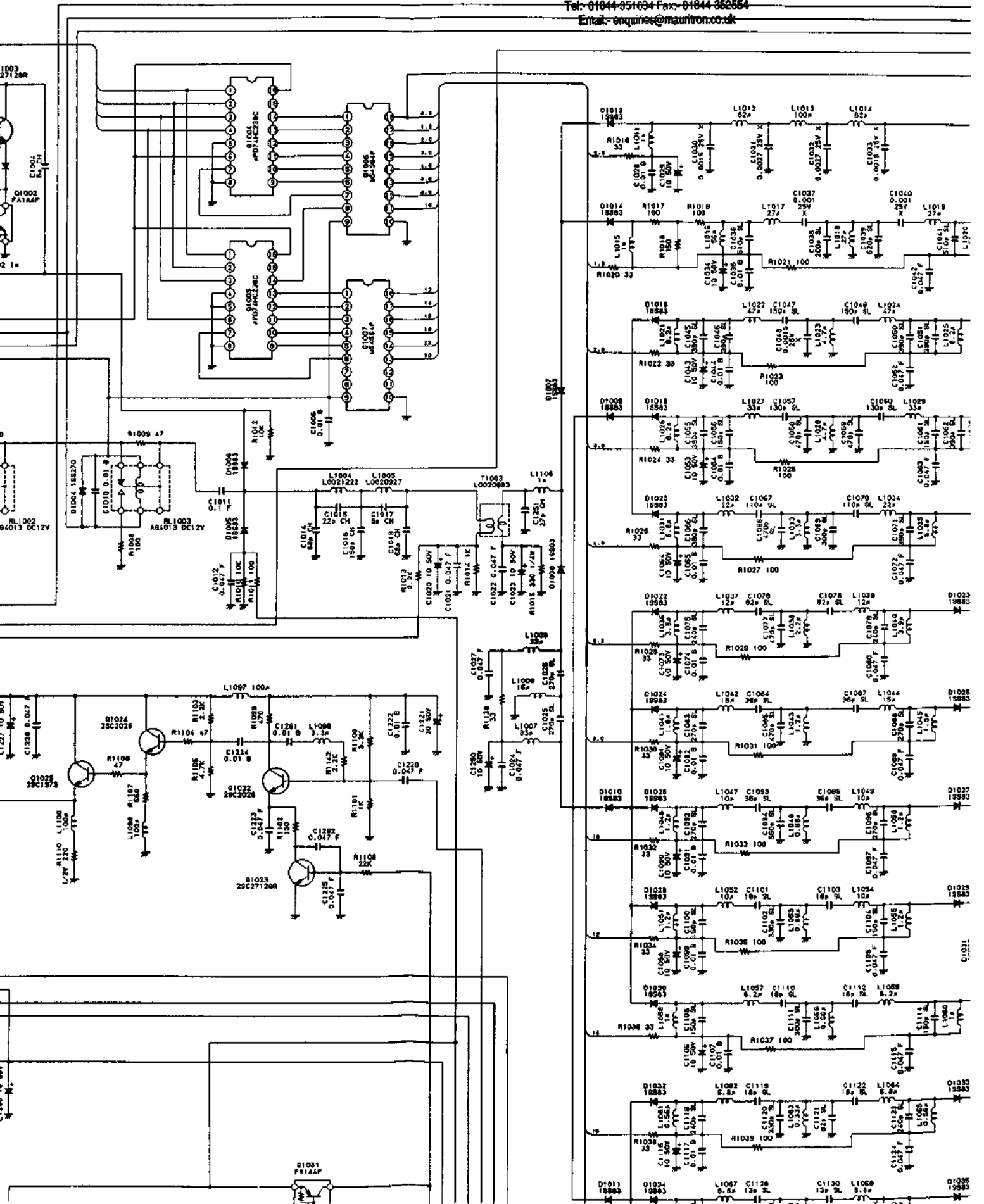

RF Unit Schematic Diagram

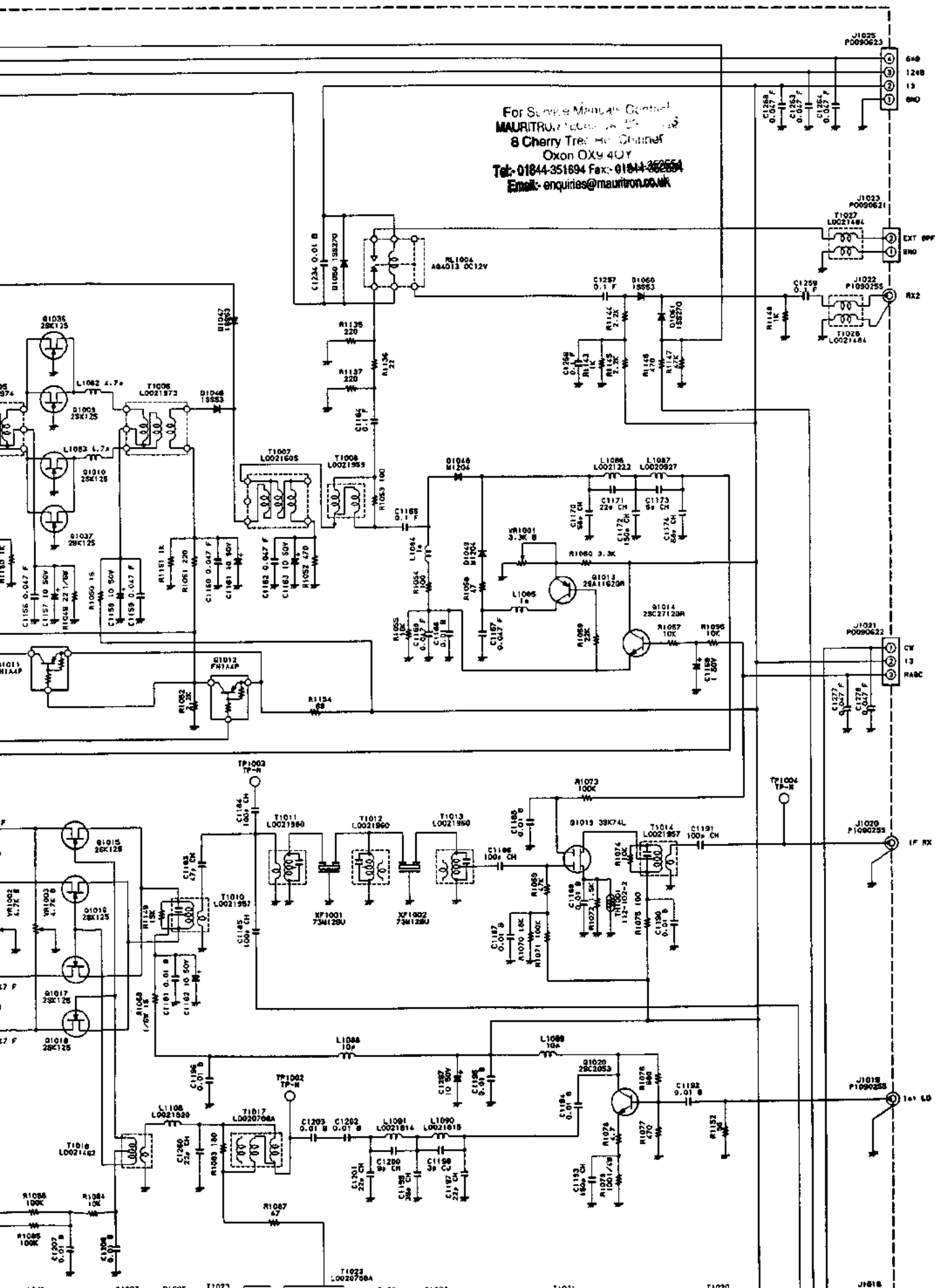

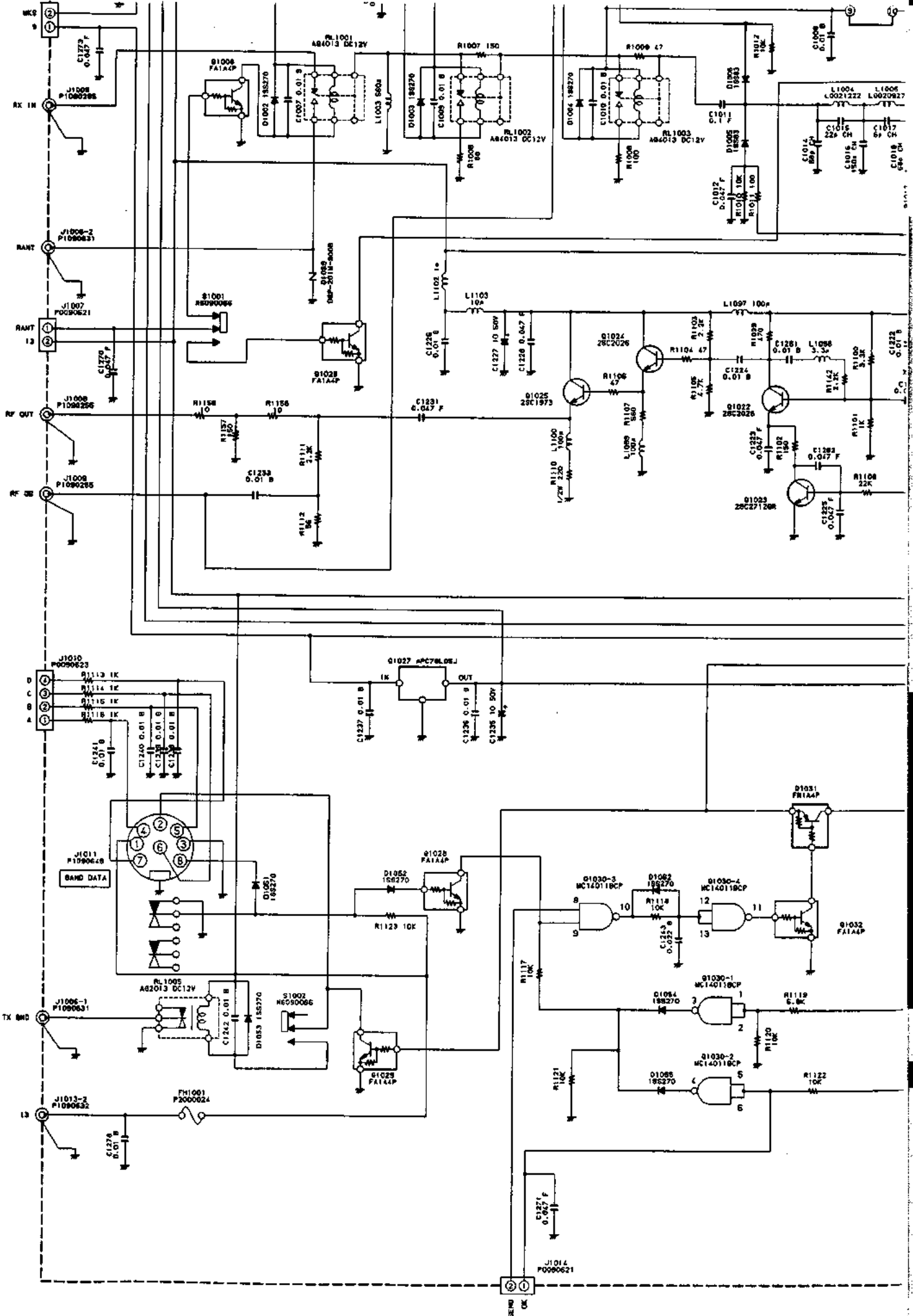

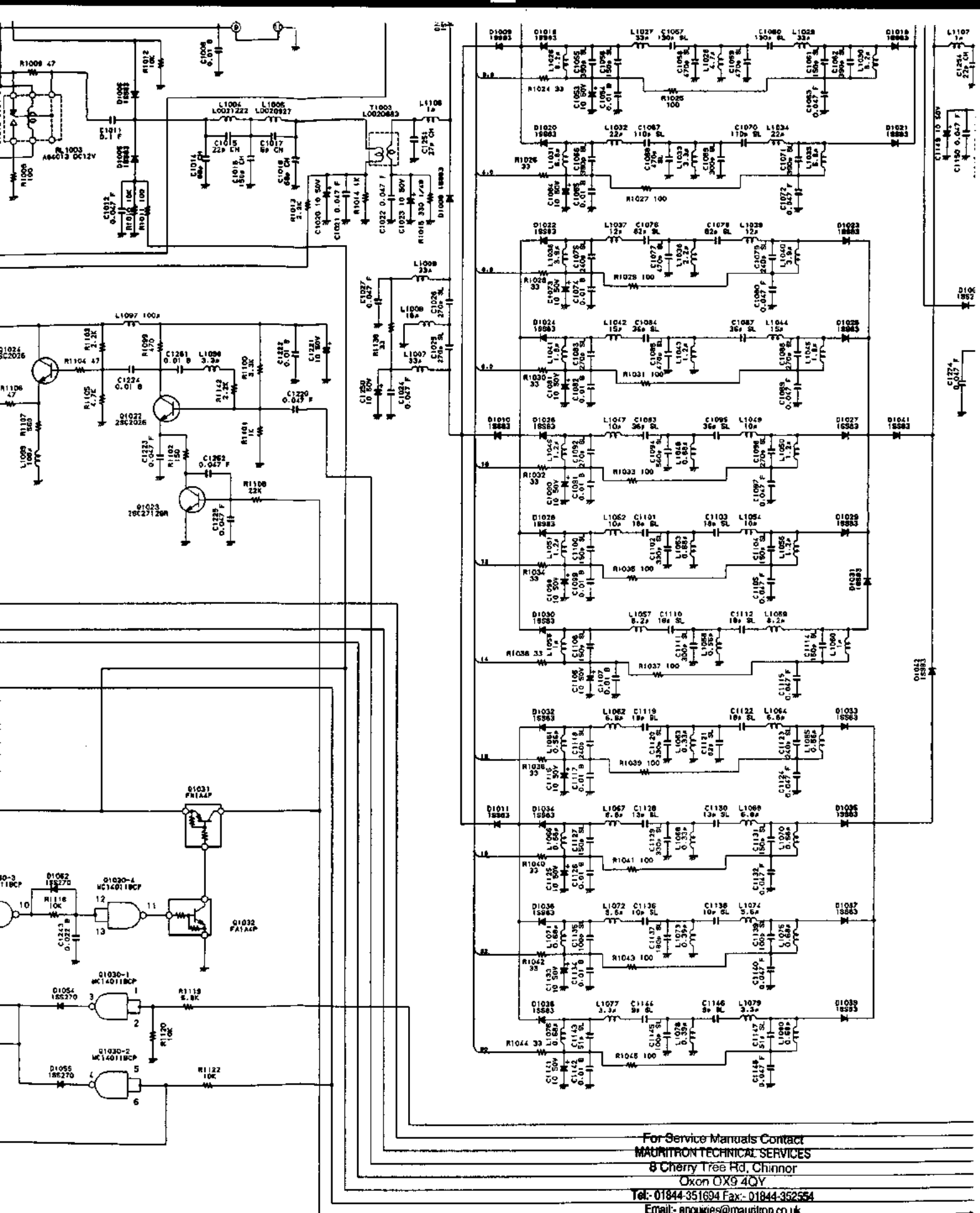

For Service Manuals Contact
MAURITRON TECHNICAL SERVICES
 8 Cherry Tree Hd, Chinnor
 Oxon OX9 4QY
 Tel: 01844-351694 Fax: 01844-352554
 Email: enquiries@mauritron.co.uk

C1274
0.027 F

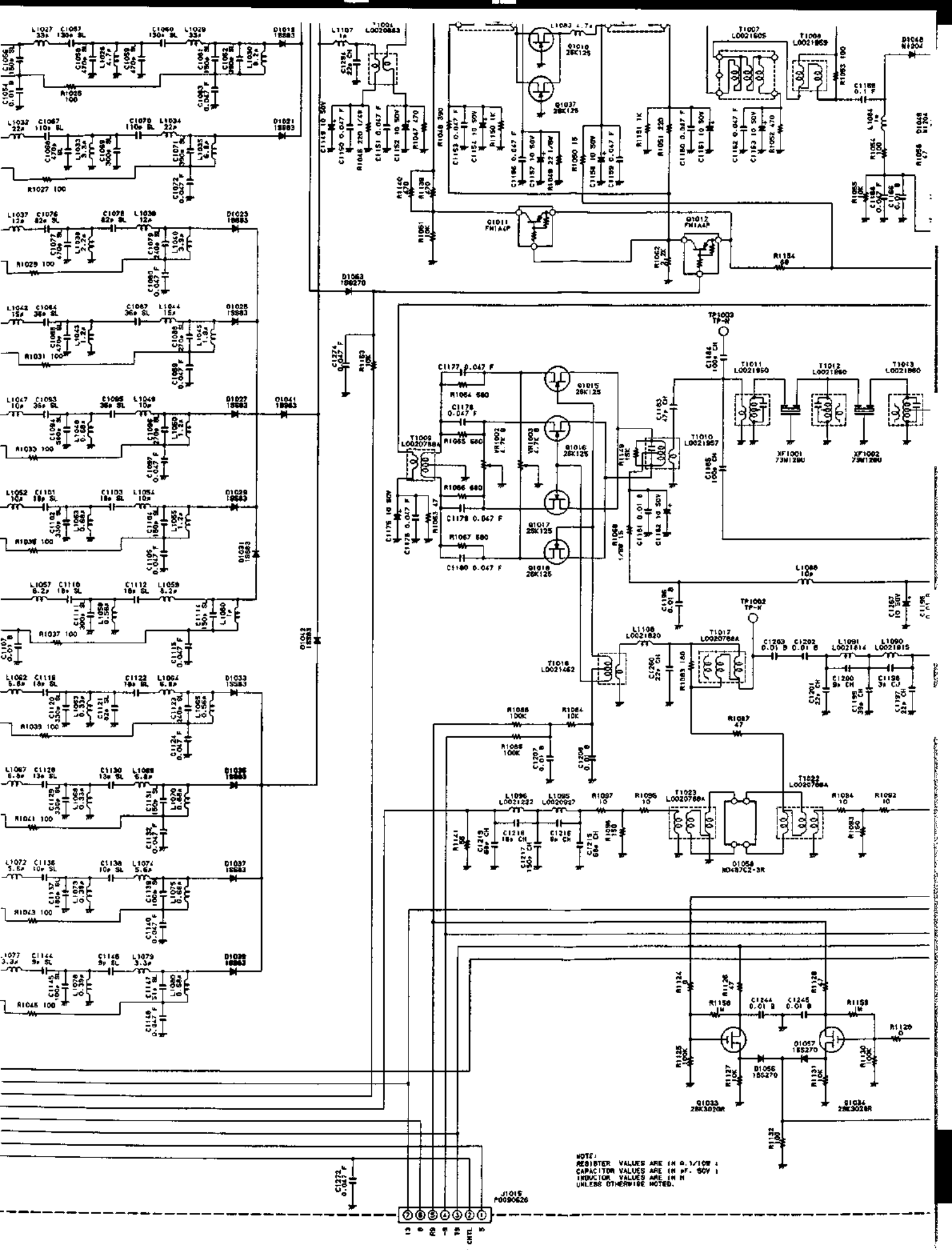

NOTE:
 RESISTOR VALUES ARE IN Ω, 1/10 Ω,
 CAPACITOR VALUES ARE IN P.F., 50V, 1
 INDUCTOR VALUES ARE IN M.H.
 UNLESS OTHERWISE NOTED.

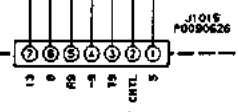

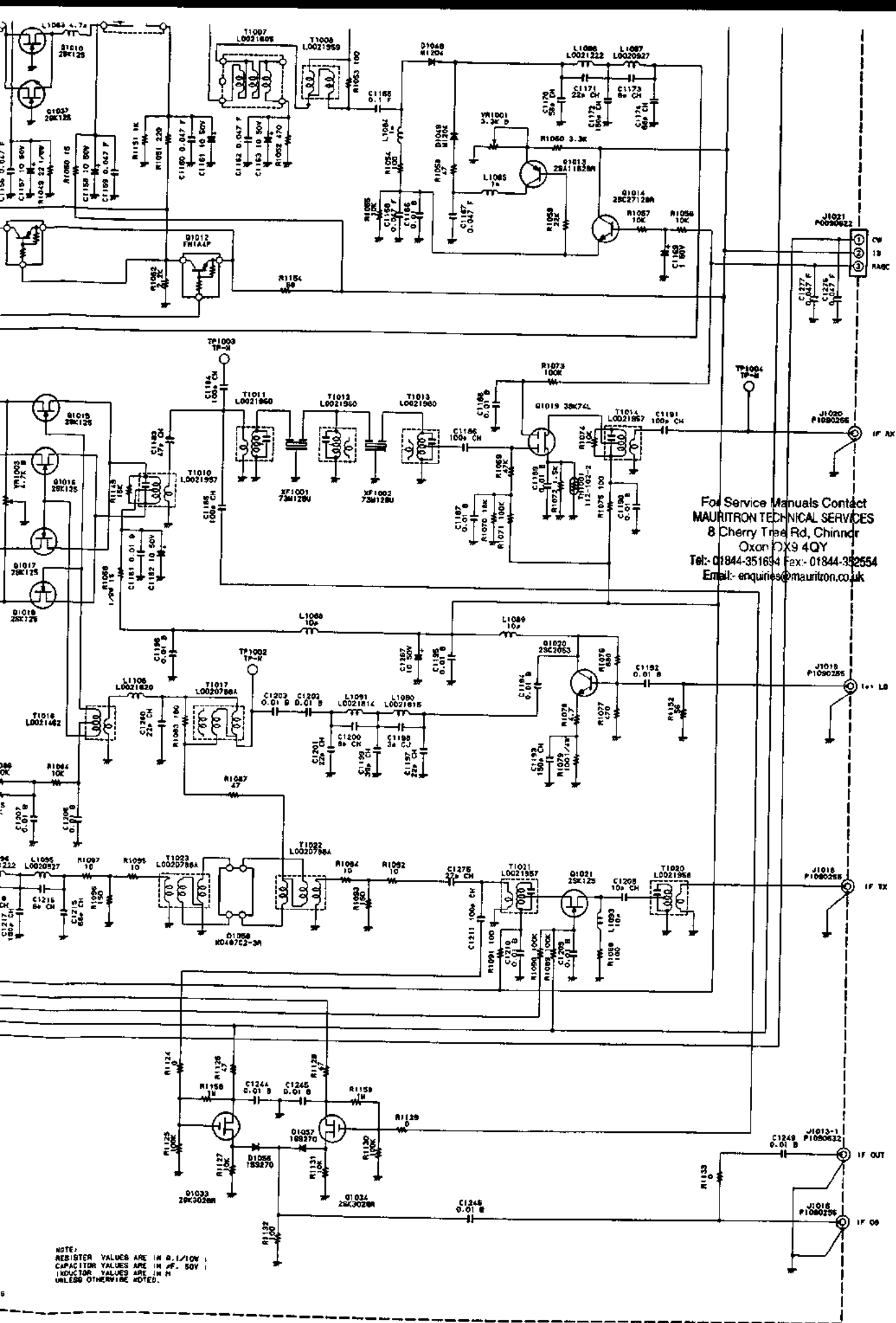

RF UNIT SCHEMATIC DIAGRAM

IF Unit Parts List

ADD	CODE NO	DESCRIPTION	DEVICE	TYP	VAL
** UNIT NAME : IF-UNIT					
C 2001	K22170805	CHIP CAP.	GRM40B102M50PT	0.001uF	50V B
C 2002	K22170817	CHIP CAP.	GRM40B103M50PT	0.01uF	50V B
C 2003	K22170805	CHIP CAP.	GRM40B102M50PT	0.001uF	50V B
C 2004	K22170805	CHIP CAP.	GRM40B102M50PT	0.001uF	50V B
C 2005	K22170817	CHIP CAP.	GRM40B103M50PT	0.01uF	50V B
C 2006	K22170817	CHIP CAP.	GRM40B103M50PT	0.01uF	50V B
C 2007	K22170817	CHIP CAP.	GRM40B103M50PT	0.01uF	50V B
C 2008	K22170817	CHIP CAP.	GRM40B103M50PT	0.01uF	50V B
C 2009	K22170817	CHIP CAP.	GRM40B103M50PT	0.01uF	50V B
C 2010	K22170817	CHIP CAP.	GRM40B103M50PT	0.01uF	50V B
C 2011	K22170235	CHIP CAP.	GRM40CH101J50PT	100pF	50V CH
C 2012	K22170817	CHIP CAP.	GRM40B103M50PT	0.01uF	50V B
C 2013	K22170817	CHIP CAP.	GRM40B103M50PT	0.01uF	50V B
C 2014	K22170817	CHIP CAP.	GRM40B103M50PT	0.01uF	50V B
C 2015	K22170817	CHIP CAP.	GRM40B103M50PT	0.01uF	50V B
C 2016	K22170817	CHIP CAP.	GRM40B103M50PT	0.01uF	50V B
C 2017	K22170817	CHIP CAP.	GRM40B103M50PT	0.01uF	50V B
C 2018	K22170235	CHIP CAP.	GRM40CH101J50PT	100pF	50V CH
C 2019	K22170817	CHIP CAP.	GRM40B103M50PT	0.01uF	50V B
C 2020	K22170235	CHIP CAP.	GRM40CH101J50PT	100pF	50V CH
C 2021	K22170243	CHIP CAP.	GRM40CH221J50PT	220pF	50V CH
C 2022	K22170243	CHIP CAP.	GRM40CH221J50PT	220pF	50V CH
C 2023	K46160004	AL. ELECTRO. CAP.	35V4R7M4X7TR2	4.7uF	35V
C 2024	K46120004	AL. ELECTRO. CAP.	16V100M4X7TR2	10uF	16V
C 2025	K22170817	CHIP CAP.	GRM40B103M50PT	0.01uF	50V B
C 2026	K46170026	AL. ELECTRO. CAP.	50VR10M4X7TR2	0.1uF	50V
C 2027	K22170817	CHIP CAP.	GRM40B103M50PT	0.01uF	50V B
C 2028	K22170817	CHIP CAP.	GRM40B103M50PT	0.01uF	50V B
C 2029	K22170817	CHIP CAP.	GRM40B103M50PT	0.01uF	50V B
C 2030	K22170817	CHIP CAP.	GRM40B103M50PT	0.01uF	50V B
C 2031	K22170817	CHIP CAP.	GRM40B103M50PT	0.01uF	50V B
C 2032	K22170211	CHIP CAP.	GRM40CH100D50PT	10pF	50V CH
C 2033	K22170817	CHIP CAP.	GRM40B103M50PT	0.01uF	50V B
C 2034	K22170211	CHIP CAP.	GRM40CH100D50PT	10pF	50V CH
C 2035	K22170817	CHIP CAP.	GRM40B103M50PT	0.01uF	50V B
C 2036	K22170817	CHIP CAP.	GRM40B103M50PT	0.01uF	50V B
C 2037	K22170817	CHIP CAP.	GRM40B103M50PT	0.01uF	50V B
C 2038	K22170817	CHIP CAP.	GRM40B103M50PT	0.01uF	50V B
C 2039	K22170817	CHIP CAP.	GRM40B103M50PT	0.01uF	50V B
C 2040	K46170030	AL. ELECTRO. CAP.	50V010M4X7TR2	1uF	50V
C 2041	K22170211	CHIP CAP.	GRM40CH100D50PT	10pF	50V CH
C 2045	K22170817	CHIP CAP.	GRM40B103M50PT	0.01uF	50V B
C 2046	K22171008	CHIP CAP.	GRM40F473Z50PT	0.047uF	50V F
C 2047	K22170817	CHIP CAP.	GRM40B103M50PT	0.01uF	50V B
C 2048	K22170817	CHIP CAP.	GRM40B103M50PT	0.01uF	50V B
C 2049	K22170817	CHIP CAP.	GRM40B103M50PT	0.01uF	50V B
C 2050	K22170817	CHIP CAP.	GRM40B103M50PT	0.01uF	50V B
C 2051	K22171008	CHIP CAP.	GRM40F473Z50PT	0.047uF	50V F
C 2052	K22170817	CHIP CAP.	GRM40B103M50PT	0.01uF	50V B
C 2053	K22170817	CHIP CAP.	GRM40B103M50PT	0.01uF	50V B
C 2054	K22171008	CHIP CAP.	GRM40F473Z50PT	0.047uF	50V F
C 2055	K22171008	CHIP CAP.	GRM40F473Z50PT	0.047uF	50V F
C 2056	K22170817	CHIP CAP.	GRM40B103M50PT	0.01uF	50V B
C 2057	K22170817	CHIP CAP.	GRM40B103M50PT	0.01uF	50V B
C 2058	K22171008	CHIP CAP.	GRM40F473Z50PT	0.047uF	50V F
C 2059	K22171008	CHIP CAP.	GRM40F473Z50PT	0.047uF	50V F
C 2060	K22170817	CHIP CAP.	GRM40B103M50PT	0.01uF	50V B
C 2061	K22170817	CHIP CAP.	GRM40B103M50PT	0.01uF	50V B
C 2062	K22171008	CHIP CAP.	GRM40F473Z50PT	0.047uF	50V F
C 2063	K22171008	CHIP CAP.	GRM40F473Z50PT	0.047uF	50V F
C 2064	K22170817	CHIP CAP.	GRM40B103M50PT	0.01uF	50V B
C 2065	K22170817	CHIP CAP.	GRM40B103M50PT	0.01uF	50V B
C 2066	K22171008	CHIP CAP.	GRM40F473Z50PT	0.047uF	50V F
C 2067	K22171008	CHIP CAP.	GRM40F473Z50PT	0.047uF	50V F
C 2068	K22170817	CHIP CAP.	GRM40B103M50PT	0.01uF	50V B
C 2069	K22170817	CHIP CAP.	GRM40B103M50PT	0.01uF	50V B
C 2070	K22171008	CHIP CAP.	GRM40F473Z50PT	0.047uF	50V F
C 2071	K22171008	CHIP CAP.	GRM40F473Z50PT	0.047uF	50V F
C 2072	K22171008	CHIP CAP.	GRM40F473Z50PT	0.047uF	50V F
C 2073	K22141809	CHIP CAP.	GRM42-6B104M25PT	0.1uF	25V B
C 2074	K22170817	CHIP CAP.	GRM40B103M50PT	0.01uF	50V B
C 2075	K22171008	CHIP CAP.	GRM40F473Z50PT	0.047uF	50V F
C 2076	K22171008	CHIP CAP.	GRM40F473Z50PT	0.047uF	50V F
C 2077	K22171008	CHIP CAP.	GRM40F473Z50PT	0.047uF	50V F
C 2078	K22171008	CHIP CAP.	GRM40F473Z50PT	0.047uF	50V F
C 2079	K22170817	CHIP CAP.	GRM40B103M50PT	0.01uF	50V B
C 2080	K22170817	CHIP CAP.	GRM40B103M50PT	0.01uF	50V B
C 2081	K46170030	AL. ELECTRO. CAP.	50V010M4X7TR2	1uF	50V
C 2082	K22171008	CHIP CAP.	GRM40F473Z50PT	0.047uF	50V F
C 2083	K22170817	CHIP CAP.	GRM40B103M50PT	0.01uF	50V B
C 2084	K46170030	AL. ELECTRO. CAP.	50V010M4X7TR2	1uF	50V
C 2085	K22171008	CHIP CAP.	GRM40F473Z50PT	0.047uF	50V F

IF Unit Parts List

ADD	CODE NO	DESCRIPTION	DEVICE	TYP	VAL
C 2086	K51176182	STYROL CAP. 50S2U182K	50S2U182K	0.0018	50V
C 2087	K51176182	STYROL CAP. 50S2U182K	50S2U182K	0.0018	50V
C 2088	K19149025	CERAMIC CAP.	UAT10X104K-L45AE	0.1uF	25V X
C 2089	K22171008	CHIP CAP.	GRM40F473Z50PT	0.047uF	50V F
C 2091	K22171008	CHIP CAP.	GRM40F473Z50PT	0.047uF	50V F
C 2092	K22171008	CHIP CAP.	GRM40F473Z50PT	0.047uF	50V F
C 2093	K22170817	CHIP CAP.	GRM40B103M50PT	0.01uF	50V B
C 2094	K46170030	AL. ELECTRO. CAP.	50V010M4X7TR2	1uF	50V
C 2095	K22171008	CHIP CAP.	GRM40F473Z50PT	0.047uF	50V F
C 2096	K22170805	CHIP CAP.	GRM40B102M50PT	0.001uF	50V B
C 2097	K22170227	CHIP CAP.	GRM40CH470J50PT	47pF	50V CH
C 2098	K22170805	CHIP CAP.	GRM40B102M50PT	0.001uF	50V B
C 2099	K22171008	CHIP CAP.	GRM40F473Z50PT	0.047uF	50V F
C 2100	K22171008	CHIP CAP.	GRM40F473Z50PT	0.047uF	50V F
C 2101	K46170030	AL. ELECTRO. CAP.	50V010M4X7TR2	1uF	50V
C 2102	K22170817	CHIP CAP.	GRM40B103M50PT	0.01uF	50V B
C 2103	K46170030	AL. ELECTRO. CAP.	50V010M4X7TR2	1uF	50V
C 2104	K22170805	CHIP CAP.	GRM40B102M50PT	0.001uF	50V B
C 2105	K22170817	CHIP CAP.	GRM40B103M50PT	0.01uF	50V B
C 2106	K46170032	AL. ELECTRO. CAP.	50V3R3M4X7TR2	3.3uF	50V
C 2107	K22170235	CHIP CAP.	GRM40CH101J50PT	100pF	50V CH
C 2108	K22170817	CHIP CAP.	GRM40B103M50PT	0.01uF	50V B
C 2109	K22170817	CHIP CAP.	GRM40B103M50PT	0.01uF	50V B
C 2110	K22141809	CHIP CAP.	GRM42-6B104M25PT	0.1uF	25V B
C 2111	K19149001	CERAMIC CAP.	UAT04X102K-L05AE	0.001uF	25V X
C 2112	K19149001	CERAMIC CAP.	UAT04X102K-L05AE	0.001uF	25V X
C 2113	K22170805	CHIP CAP.	GRM40B102M50PT	0.001uF	50V B
C 2114	K22170237	CHIP CAP.	GRM40CH121J50PT	120pF	50V CH
C 2115	K22141809	CHIP CAP.	GRM42-6B104M25PT	0.1uF	25V B
C 2116	K22170817	CHIP CAP.	GRM40B103M50PT	0.01uF	50V B
C 2117	K46160004	AL. ELECTRO. CAP.	35V4R7M4X7TR2	4.7uF	35V
C 2118	K46170030	AL. ELECTRO. CAP.	50V010M4X7TR2	1uF	50V
C 2119	K46170029	AL. ELECTRO. CAP.	50VR47M4X7TR2	0.47uF	50V
C 2120	K50177223	FILM CAP. 50F2U223M	50F2U223M	0.022	50V
C 2121	K22141809	CHIP CAP.	GRM42-6B104M25PT	0.1uF	25V B
C 2122	K22141809	CHIP CAP.	GRM42-6B104M25PT	0.1uF	25V B
C 2123	K22170251	CHIP CAP.	GRM40CH471J50PT	470pF	50V CH
C 2124	K46170030	AL. ELECTRO. CAP.	50V010M4X7TR2	1uF	50V
C 2125	K22170813	CHIP CAP.	GRM40B472M50PT	0.0047uF	50V B
C 2126	K46170030	AL. ELECTRO. CAP.	50V010M4X7TR2	1uF	50V
C 2127	K46100007	AL. ELECTRO. CAP.	10V330M4X7TR2	33uF	10V
C 2128	K46120005	AL. ELECTRO. CAP.	16V220M5X7TR2	22uF	16V
C 2129	K22170243	CHIP CAP.	GRM40CH221J50PT	220pF	50V CH
C 2130	K22170805	CHIP CAP.	GRM40B102M50PT	0.001uF	50V B
C 2131	K22170251	CHIP CAP.	GRM40CH471J50PT	470pF	50V CH
C 2132	K22171008	CHIP CAP.	GRM40F473Z50PT	0.047uF	50V F
C 2133	K46170030	AL. ELECTRO. CAP.	50V010M4X7TR2	1uF	50V
C 2134	K46170030	AL. ELECTRO. CAP.	50V010M4X7TR2	1uF	50V
C 2136	K22170219	CHIP CAP.	GRM40CH220J50PT	22pF	50V CH
C 2137	K22170202	CHIP CAP.	GRM40CK010C50PT	1pF	50V CK
C 2138	K22170817	CHIP CAP.	GRM40B103M50PT	0.01uF	50V B
C 2139	K22170805	CHIP CAP.	GRM40B102M50PT	0.001uF	50V B
C 2140	K22170805	CHIP CAP.	GRM40B102M50PT	0.001uF	50V B
C 2141	K22171008	CHIP CAP.	GRM40F473Z50PT	0.047uF	50V F
C 2142	K22170817	CHIP CAP.	GRM40B103M50PT	0.01uF	50V B
C 2143	K22170817	CHIP CAP.	GRM40B103M50PT	0.01uF	50V B
C 2144	K22170817	CHIP CAP.	GRM40B103M50PT	0.01uF	50V B
C 2145	K22170817	CHIP CAP.	GRM40B103M50PT	0.01uF	50V B
C 2146	K22171008	CHIP CAP.	GRM40F473Z50PT	0.047uF	50V F
C 2147	K22170817	CHIP CAP.	GRM40B103M50PT	0.01uF	50V B
C 2148	K22170223	CHIP CAP.	GRM40CH330J50PT	33pF	50V CN
C 2149	K22170817	CHIP CAP.	GRM40B103M50PT	0.01uF	50V B
C 2150	K22170817	CHIP CAP.	GRM40B103M50PT	0.01uF	50V B
C 2151	K22170817	CHIP CAP.	GRM40B103M50PT	0.01uF	50V B
C 2152	K22170817	CHIP CAP.	GRM40B103M50PT	0.01uF	50V B
C 2153	K22171008	CHIP CAP.	GRM40F473Z50PT	0.047uF	50V F
C 2154	K22171008	CHIP CAP.	GRM40F473Z50PT	0.047uF	50V F
C 2155	K22171008	CHIP CAP.	GRM40F473Z50PT	0.047uF	50V F
C 2156	K22170817	CHIP CAP.	GRM40B103M50PT	0.01uF	50V B
C 2157	K22170805	CHIP CAP.	GRM40B102M50PT	0.001uF	50V B
C 2158	K22170817	CHIP CAP.	GRM40B103M50PT	0.01uF	50V B
C 2159	K22170805	CHIP CAP.	GRM40B102M50PT	0.001uF	50V B
C 2160	K22170817	CHIP CAP.	GRM40B103M50PT	0.01uF	50V B
C 2161	K46170030	AL. ELECTRO. CAP.	50V010M4X7TR2	1uF	50V
C 2162	K22171008	CHIP CAP.	GRM40F473Z50PT	0.047uF	50V F
C 2163	K22171008	CHIP CAP.	GRM40F473Z50PT	0.047uF	50V F
C 2164	K46170030	AL. ELECTRO. CAP.	50V010M4X7TR2	1uF	50V
C 2165	K22171008	CHIP CAP.	GRM40F473Z50PT	0.047uF	50V F
C 2166	K22171008	CHIP CAP.	GRM40F473Z50PT	0.047uF	50V F
C 2167	K22170817	CHIP CAP.	GRM40B103M50PT	0.01uF	50V B
C 2168	K22170817	CHIP CAP.	GRM40B103M50PT	0.01uF	50V B
C 2169	K22170817	CHIP CAP.	GRM40B103M50PT	0.01uF	50V B
C 2170	K22171008	CHIP CAP.	GRM40F473Z50PT	0.047uF	50V F

For Service Manuals Contact
MAURITRON TECHNICAL SERVICES
 8 Cherry Tree Rd, Chinnor
 Oxon OX9 4DY
 Tel: 01844-351684 Fax: 01844-352554
 Email: enquiries@mauritron.co.uk

IF Unit Parts List

ADD	CODE NO	DESCRIPTION	DEVICE	TYP	VAL
C 2171	K22170817	CHIP CAP.	GRM40B103M50PT	0.01uF	50V B
C 2172	K22171008	CHIP CAP.	GRM40F473Z50PT	0.047uF	50V F
C 2173	K22170817	CHIP CAP.	GRM40B103M50PT	0.01uF	50V B
C 2174	K22170235	CHIP CAP.	GRM40CH101J50PT	100pF	50V CH
C 2175	K22141809	CHIP CAP.	GRM42-6B104M25PT	0.1uF	25V B
C 2176	K22170817	CHIP CAP.	GRM40B103M50PT	0.01uF	50V B
C 2177	K22170817	CHIP CAP.	GRM40B103M50PT	0.01uF	50V B
C 2178	K22170817	CHIP CAP.	GRM40B103M50PT	0.01uF	50V B
C 2179	K22170817	CHIP CAP.	GRM40B103M50PT	0.01uF	50V B
C 2180	K22170817	CHIP CAP.	GRM40B103M50PT	0.01uF	50V B
C 2181	K22170817	CHIP CAP.	GRM40B103M50PT	0.01uF	50V B
C 2184	K22170223	CHIP CAP.	GRM40CH330J50PT	33pF	50V CH
C 2185	K22170817	CHIP CAP.	GRM40B103M50PT	0.01uF	50V B
C 2186	K22170817	CHIP CAP.	GRM40B103M50PT	0.01uF	50V B
C 2187	K22170225	CHIP CAP.	GRM40CH390J50PT	39pF	50V CH
C 2188	K22170223	CHIP CAP.	GRM40CH330J50PT	33pF	50V CH
C 2189	K22170817	CHIP CAP.	GRM40B103M50PT	0.01uF	50V B
C 2190	K22170817	CHIP CAP.	GRM40B103M50PT	0.01uF	50V B
C 2191	K46120004	AL. ELECTRO. CAP.	16V100M4X7TR2	10uF	16V
C 2192	K22171008	CHIP CAP.	GRM40F473Z50PT	0.047uF	50V F
C 2193	K22170206	CHIP CAP.	GRM40CH050C50PT	5pF	50V CH
C 2194	K22170817	CHIP CAP.	GRM40B103M50PT	0.01uF	50V B
C 2195	K46170030	AL. ELECTRO. CAP.	50V010M4X7TR2	1uF	50V
C 2196	K46170030	AL. ELECTRO. CAP.	50V010M4X7TR2	1uF	50V
C 2197	K22170817	CHIP CAP.	GRM40B103M50PT	0.01uF	50V B
C 2198	K22170817	CHIP CAP.	GRM40B103M50PT	0.01uF	50V B
C 2201	K22170817	CHIP CAP.	GRM40B103M50PT	0.01uF	50V B
C 2203	K22170206	CHIP CAP.	GRM40CH050C50PT	5pF	50V CH
C 2204	K22170817	CHIP CAP.	GRM40B103M50PT	0.01uF	50V B
C 2205	K22170219	CHIP CAP.	GRM40CH220J50PT	22pF	50V CH
C 2206	K22170235	CHIP CAP.	GRM40CH101J50PT	100pF	50V CH
C 2207	K22170817	CHIP CAP.	GRM40B103M50PT	0.01uF	50V B
C 2208	K22170817	CHIP CAP.	GRM40B103M50PT	0.01uF	50V B
C 2210	K22170223	CHIP CAP.	GRM40CH330J50PT	33pF	50V CH
C 2211	K22170223	CHIP CAP.	GRM40CH330J50PT	33pF	50V CH
C 2212	K22170817	CHIP CAP.	GRM40B103M50PT	0.01uF	50V B
C 2213	K22170817	CHIP CAP.	GRM40B103M50PT	0.01uF	50V B
C 2214	K22170817	CHIP CAP.	GRM40B103M50PT	0.01uF	50V B
C 2215	K22170223	CHIP CAP.	GRM40CH330J50PT	33pF	50V CH
C 2216	K22170817	CHIP CAP.	GRM40B103M50PT	0.01uF	50V B
C 2217	K22170817	CHIP CAP.	GRM40B103M50PT	0.01uF	50V B
C 2218	K22170241	CHIP CAP.	GRM40CH181J50PT	180pF	50V CH
C 2219	K22170241	CHIP CAP.	GRM40CH181J50PT	180pF	50V CH
C 2220	K22170211	CHIP CAP.	GRM40CH100D50PT	10pF	50V CH
C 2221	K22170817	CHIP CAP.	GRM40B103M50PT	0.01uF	50V B
C 2223	K22170817	CHIP CAP.	GRM40B103M50PT	0.01uF	50V B
C 2224	K22170817	CHIP CAP.	GRM40B103M50PT	0.01uF	50V B
C 2226	K22170219	CHIP CAP.	GRM40CH220J50PT	22pF	50V CH
C 2227	K22170247	CHIP CAP.	GRM40CH331J50PT	330pF	50V CH
C 2228	K22170247	CHIP CAP.	GRM40CH331J50PT	330pF	50V CH
C 2230	K22170817	CHIP CAP.	GRM40B103M50PT	0.01uF	50V B
C 2231	K22170817	CHIP CAP.	GRM40B103M50PT	0.01uF	50V B
C 2232	K22170805	CHIP CAP.	GRM40B102M50PT	0.001uF	50V B
C 2240	K46120004	AL. ELECTRO. CAP.	16V100M4X7TR2	10uF	16V
C 2241	K46170029	AL. ELECTRO. CAP.	50VR47M4X7TR2	0.47uF	50V
C 2242	K22170243	CHIP CAP.	GRM40CH221J50PT	220pF	50V CH
C 2243	K22170235	CHIP CAP.	GRM40CH101J50PT	100pF	50V CH
C 2244	K22171008	CHIP CAP.	GRM40F473Z50PT	0.047uF	50V F
C 2245	K22171008	CHIP CAP.	GRM40F473Z50PT	0.047uF	50V F
C 2246	K22171008	CHIP CAP.	GRM40F473Z50PT	0.047uF	50V F
C 2248	K22171008	CHIP CAP.	GRM40F473Z50PT	0.047uF	50V F
C 2249	K22170805	CHIP CAP.	GRM40B102M50PT	0.001uF	50V B
C 2250	K22170805	CHIP CAP.	GRM40B102M50PT	0.001uF	50V B
C 2260	K22171008	CHIP CAP.	GRM40F473Z50PT	0.047uF	50V F
C 2261	K22170202	CHIP CAP.	GRM40CK010C50PT	1pF	50V CK
C 2262	K22170223	CHIP CAP.	GRM40CH330J50PT	33pF	50V CH
C 2263	K22170223	CHIP CAP.	GRM40CH330J50PT	33pF	50V CH
C 2264	K22170817	CHIP CAP.	GRM40B103M50PT	0.01uF	50V B
C 2265	K22170817	CHIP CAP.	GRM40B103M50PT	0.01uF	50V B
C 2266	K22170817	CHIP CAP.	GRM40B103M50PT	0.01uF	50V B
C 2267	K22170817	CHIP CAP.	GRM40B103M50PT	0.01uF	50V B
C 2268	K22170817	CHIP CAP.	GRM40B103M50PT	0.01uF	50V B
C 2269	K22170817	CHIP CAP.	GRM40B103M50PT	0.01uF	50V B
C 2270	K46170030	AL. ELECTRO. CAP.	50V010M4X7TR2	1uF	50V
C 2271	K46160004	AL. ELECTRO. CAP.	35V4R7M4X7TR2	4.7uF	35V
C 2272	K46170032	AL. ELECTRO. CAP.	50V3R3M4X7TR2	3.3uF	50V
C 2273	K22170219	CHIP CAP.	GRM40CH220J50PT	22pF	50V CH
C 2274	K22171008	CHIP CAP.	GRM40F473Z50PT	0.047uF	50V F
C 2275	K22171008	CHIP CAP.	GRM40F473Z50PT	0.047uF	50V F
C 2276	K22171008	CHIP CAP.	GRM40F473Z50PT	0.047uF	50V F
C 2277	K22170219	CHIP CAP.	GRM40CH220J50PT	22pF	50V CH
C 2278	K22170219	CHIP CAP.	GRM40CH220J50PT	22pF	50V CH
C 2279	K22170219	CHIP CAP.	GRM40CH220J50PT	22pF	50V CH

IF Unit Parts List

ADD	CODE NO	DESCRIPTION	DEVICE	TYP	VAL
C 2280	K22170219	CHIP CAP.	GRM40CH220J50PT	22pF	50V CH
C 2281	K22170203	CHIP CAP.	GRM40CK020C50PT	2pF	50V CK
C 2282	K22170805	CHIP CAP.	GRM40B102M50PT	0.001uF	50V B
C 2283	K22170817	CHIP CAP.	GRM40B103M50PT	0.01uF	50V B
C 2284	K22171008	CHIP CAP.	GRM40F473Z50PT	0.047uF	50V F
C 2285	K22171008	CHIP CAP.	GRM40F473Z50PT	0.047uF	50V F
C 2286	K22171008	CHIP CAP.	GRM40F473Z50PT	0.047uF	50V F
C 2287	K22170817	CHIP CAP.	GRM40B103M50PT	0.01uF	50V B
C 2288	K22170201	CHIP CAP.	GRM40CK0R5C50PT	0.5pF	50V CK
CD2001	H7900180	CERAMIC DISC	CDB455C7		
CF2001	H3900387	CERAMIC FILTER	LF-H85		
CF2002	H3900401	CERAMIC FILTER	SLF-D6Y		
D 2001	G2060004	DIODE	1SS270TJ		
D 2002	G2090244	DIODE	1SS106		
D 2003	G2090244	DIODE	1SS106		
D 2004	G2060004	DIODE	1SS270TJ		
D 2005	G2070009	DIODE	1SS184 TE85R		
D 2006	G2060004	DIODE	1SS270TJ		
D 2007	G2060004	DIODE	1SS270TJ		
D 2008	G2060004	DIODE	1SS270TJ		
D 2009	G2060004	DIODE	1SS270TJ		
D 2010	G2060004	DIODE	1SS270TJ		
D 2011	G2060004	DIODE	1SS270TJ		
D 2012	G2060004	DIODE	1SS270TJ		
D 2013	G2060004	DIODE	1SS270TJ		
D 2014	G2060004	DIODE	1SS270TJ		
D 2015	G2060004	DIODE	1SS270TJ		
D 2016	G2060004	DIODE	1SS270TJ		
D 2017	G2060004	DIODE	1SS270TJ		
D 2018	G2060004	DIODE	1SS270TJ		
D 2019	G2060004	DIODE	1SS270TJ		
D 2020	G2060004	DIODE	1SS270TJ		
D 2021	G2060004	DIODE	1SS270TJ		
D 2022	G2060004	DIODE	1SS270TJ		
D 2023	G2060004	DIODE	1SS270TJ		
D 2024	G2060004	DIODE	1SS270TJ		
D 2026	G2060004	DIODE	1SS270TJ		
D 2027	G2060004	DIODE	1SS270TJ		
D 2028	G2060004	DIODE	1SS270TJ		
D 2029	G2060004	DIODE	1SS270TJ		
D 2030	G2060004	DIODE	1SS270TJ		
D 2031	G2060004	DIODE	1SS270TJ		
D 2033	G2060004	DIODE	1SS270TJ		
D 2034	G2060004	DIODE	1SS270TJ		
D 2035	G2060004	DIODE	1SS270TJ		
D 2036	G2060004	DIODE	1SS270TJ		
D 2037	G2060004	DIODE	1SS270TJ		
D 2038	G2060004	DIODE	1SS270TJ		
D 2039	G2060004	DIODE	1SS270TJ		
D 2040	G2060004	DIODE	1SS270TJ		
D 2041	G2060004	DIODE	1SS270TJ		
D 2042	G2060004	DIODE	1SS270TJ		
D 2043	G2060004	DIODE	1SS270TJ		
D 2044	G2060004	DIODE	1SS270TJ		
D 2048	G2060004	DIODE	1SS270TJ		
D 2049	G2060004	DIODE	1SS270TJ		
D 2050	G2060004	DIODE	1SS270TJ		
D 2051	G2060004	DIODE	1SS270TJ		
D 2052	G2060004	DIODE	1SS270TJ		
D 2053	G2060004	DIODE	1SS270TJ		
D 2054	G2060004	DIODE	1SS270TJ		
D 2055	G2060004	DIODE	1SS270TJ		
D 2056	G2060004	DIODE	1SS270TJ		
D 2057	G2060004	DIODE	1SS270TJ		
D 2058	G2060004	DIODE	1SS270TJ		
D 2059	G2060004	DIODE	1SS270TJ		
D 2060	G2090244	DIODE	1SS106		
D 2061	G2090244	DIODE	1SS106		
D 2062	G2090244	DIODE	1SS106		
D 2065	G2060004	DIODE	1SS270TJ		
D 2067	G2060004	DIODE	1SS270TJ		
D 2068	G2060004	DIODE	1SS270TJ		
D 2069	G2060004	DIODE	1SS270TJ		
D 2070	G2060004	DIODE	1SS270TJ		
D 2071	G2070009	DIODE	1SS184 TE85R		
D 2072	G2060004	DIODE	1SS270TJ		
D 2073	G2060004	DIODE	1SS270TJ		
D 2074	G9090007	VARIATOR MV-12	MV-12 (KB265)		
D 2075	G2090180	DIODE	FC-53N-5		
D 2078	G2090244	DIODE	1SS106		
D 2079	G2090244	DIODE	1SS106		
D 2080	G2090185	DIODE	FC-52N-5		
D 2081	G2060004	DIODE	1SS270TJ		

For Service Manuals Contact
MAURITRON TECHNICAL SERVICES
 8 Cherry Tree Rd, Chinnor
 Oxon OX9 4QY
 Tel: 01844-351894 Fax: 01844-352554
 Email: enquiries@mauritron.co.uk

IF Unit Parts List

ADD	CODE NO	DESCRIPTION	DEVICE	TYP VAL	
D	2082	G2060004	DIODE	1SS270TJ	
D	2084	G2060004	DIODE	1SS270TJ	
D	2085	G2060004	DIODE	1SS270TJ	
D	2086	G2060004	DIODE	1SS270TJ	
D	2087	G2060004	DIODE	1SS270TJ	
D	2088	G2060004	DIODE	1SS270TJ	
D	2090	G2070009	DIODE	1SS184 TE85R	
D	2091	G2070009	DIODE	1SS184 TE85R	
D	2092	G2070009	DIODE	1SS184 TE85R	
D	2093	G2070009	DIODE	1SS184 TE85R	
D	2094	G2060004	DIODE	1SS270TJ	
D	2095	G2060004	DIODE	1SS270TJ	
D	2096	G2060004	DIODE	1SS270TJ	
D	2097	G2060004	DIODE	1SS270TJ	
D	2098	G2060004	DIODE	1SS270TJ	
D	2099	G2060004	DIODE	1SS270TJ	
D	2100	G2060004	DIODE	1SS270TJ	
D	2101	G2060004	DIODE	1SS270TJ	
D	2102	G2060004	DIODE	1SS270TJ	
D	2103	G2090027	DIODE	1SS53	
D	2104	G2070003	DIODE	1SS226 TE85R	
J	2001	P0090624	CONNECTOR	SC25-05WS	
J	2002	P0090621	CONNECTOR	SC25-02WS	
J	2003	P1090255	CONNECTOR	TMP-JA	
J	2004	P1090255	CONNECTOR	TMP-JA	
J	2005	P0090622	CONNECTOR	SC25-03WS	
J	2006	P0090625	CONNECTOR	SC25-06WS	
J	2007	P0090626	CONNECTOR	SC25-07WS	
J	2008	P0090626	CONNECTOR	SC25-07WS	
J	2009	P0090622	CONNECTOR	SC25-03WS	
J	2010	P0090621	CONNECTOR	SC25-02WS	
J	2011	P0090621	CONNECTOR	SC25-02WS	
J	2012	P1090255	CONNECTOR	TMP-JA	
J	2013	P1090255	CONNECTOR	TMP-JA	
J	2014	P1090255	CONNECTOR	TMP-JA	
J	2015	P0090621	CONNECTOR	SC25-02WS	
J	2017	P1090255	CONNECTOR	TMP-JA	
J	2018	P1090255	CONNECTOR	TMP-JA	
J	2019	P0090621	CONNECTOR	SC25-02WS	
J	2020	P0090624	CONNECTOR	SC25-05WS	
J	2021	P0090621	CONNECTOR	SC25-02WS	
J	2022	P0090621	CONNECTOR	SC25-02WS	
J	2023	P0090621	CONNECTOR	SC25-02WS	
J	2024	P0090621	CONNECTOR	SC25-02WS	
J	2025	P0090621	CONNECTOR	SC25-02WS	
J	2026	P0090624	CONNECTOR	SC25-05WS	
J	2027	P0090624	CONNECTOR	SC25-05WS	
J	2028	P0090624	CONNECTOR	SC25-05WS	
J	2029	P0090523	CONNECTOR	3022-04B	
J	2030	P0090523	CONNECTOR	3022-04B	
J	2031	P0090523	CONNECTOR	3022-04B	
J	2032	P0090523	CONNECTOR	3022-04B	
J	2033	P0090523	CONNECTOR	3022-04B	
J	2034	P0090523	CONNECTOR	3022-04B	
J	2035	P0090523	CONNECTOR	3022-04B	
J	2036	P0090523	CONNECTOR	3022-04B	
J	2037	P0090523	CONNECTOR	3022-04B	
J	2038	P0090523	CONNECTOR	3022-04B	
J	2039	P0090523	CONNECTOR	3022-04B	
J	2040	P0090523	CONNECTOR	3022-04B	
L	2001	L1790072	M.RFC	LAP02TA151K	150uH
L	2002	L1790072	M.RFC	LAP02TA151K	150uH
L	2003	L1790072	M.RFC	LAP02TA151K	150uH
L	2004	L1790072	M.RFC	LAP02TA151K	150uH
L	2005	L1790072	M.RFC	LAP02TA151K	150uH
L	2006	L1790072	M.RFC	LAP02TA151K	150uH
L	2007	L1790072	M.RFC	LAP02TA151K	150uH
L	2008	L1790072	M.RFC	LAP02TA151K	150uH
L	2009	L1790072	M.RFC	LAP02TA151K	150uH
L	2010	L1790072	M.RFC	LAP02TA151K	150uH
L	2012	L1790072	M.RFC	LAP02TA151K	150uH
L	2013	L1190102	M.RFC	S17-104K	100m
L	2014	L1190102	M.RFC	S17-104K	100m
L	2015	L1190382	M.RFC	RCR-875D-222K	2.2m
L	2016	L1790072	M.RFC	LAP02TA151K	150uH
L	2018	L1790070	M.RFC	LAP02TA101K	100uH
L	2020	L1790119	M.RFC	LAL03TA102K	1mH
L	2022	L1790059	M.RFC	LAP02TA100K	10uH
L	2023	L1790072	M.RFC	LAP02TA151K	150uH
L	2024	L1790072	M.RFC	LAP02TA151K	150uH
L	2025	L1790046	M.RFC	LAP02TA1R0K	1uH
L	2026	L1790119	M.RFC	LAL03TA102K	1mH
L	2027	L1790072	M.RFC	LAP02TA151K	150uH

IF Unit Parts List

ADD	CODE NO	DESCRIPTION	DEVICE	TYP VAL
L 2028	L1790119	M.RFC	LAL03TA102K	1mH
L 2029	L1790060	M.RFC	LAP02TA150K	15uH
L 2030	L1790119	M.RFC	LAL03TA102K	1mH
Q 2001	G3070006	TRANSISTOR	FA1A4P-T2B	
Q 2002	G3070006	TRANSISTOR	FA1A4P-T2B	
Q 2003	G4800740L	FET	3SK74L	
Q 2004	G4800740L	FET	3SK74L	
Q 2005	G3327127G	TRANSISTOR	2SC2712GR TE85R	
Q 2006	G3327127G	TRANSISTOR	2SC2712GR TE85R	
Q 2007	G3801607F	FET	2SK160-T2B K6	
Q 2008	G3327127G	TRANSISTOR	2SC2712GR TE85R	
Q 2009	G3111627G	TRANSISTOR	2SA1162GR TE85R	
Q 2010	G1090649	IC	M5218L	
Q 2011	G3327127G	TRANSISTOR	2SC2712GR TE85R	
Q 2012	G3070011	TRANSISTOR	FN1A4P-T2B	
Q 2013	G3803027G	FET	2SK302GR TE85R	
Q 2014	G3803027G	FET	2SK302GR TE85R	
Q 2015	G1090101	IC	UPC1037H	
Q 2016	G3803027G	FET	2SK302GR TE85R	
Q 2017	G1090145	IC	MC3357P	
Q 2018	G4800740L	FET	3SK74L	
Q 2019	G4800740L	FET	3SK74L	
Q 2020	G3070006	TRANSISTOR	FA1A4P-T2B	
Q 2023	G3327127G	TRANSISTOR	2SC2712GR TE85R	
Q 2024	G4800740L	FET	3SK74L	
Q 2025	G1090283	IC	UPD4066BC	
Q 2026	G1090649	IC	M5218L	
Q 2027	G3327127G	TRANSISTOR	2SC2712GR TE85R	
Q 2028	G3327127G	TRANSISTOR	2SC2712GR TE85R	
Q 2029	G3327127G	TRANSISTOR	2SC2712GR TE85R	
Q 2030	G3070006	TRANSISTOR	FA1A4P-T2B	
Q 2031	G3070011	TRANSISTOR	FN1A4P-T2B	
Q 2032	G3803027G	FET	2SK302GR TE85R	
Q 2033	G3803027G	FET	2SK302GR TE85R	
Q 2034	G4800740L	FET	3SK74L	
Q 2035	G1090101	IC	UPC1037H	
Q 2036	G4800740L	FET	3SK74L	
Q 2037	G1090413	IC	TA7302P	
Q 2038	G4800740L	FET	3SK74L	
Q 2039	G3801607F	FET	2SK160-T2B K6	
Q 2040	G3070006	TRANSISTOR	FA1A4P-T2B	
Q 2041	G3070006	TRANSISTOR	FA1A4P-T2B	
Q 2042	G1090283	IC	UPD4066BC	
Q 2043	G3070006	TRANSISTOR	FA1A4P-T2B	
Q 2044	G3327127G	TRANSISTOR	2SC2712GR TE85R	
Q 2045	G4800740L	FET	3SK74L	
Q 2046	G3070011	TRANSISTOR	FN1A4P-T2B	
Q 2047	G3070006	TRANSISTOR	FA1A4P-T2B	
Q 2048	G3327147Y	TRANSISTOR	2SC2714YTE85R	
Q 2049	G3327127G	TRANSISTOR	2SC2712GR TE85R	
Q 2050	G3327127G	TRANSISTOR	2SC2712GR TE85R	
Q 2051	G1090101	IC	UPC1037H	
Q 2052	G3327127G	TRANSISTOR	2SC2712GR TE85R	
Q 2053	G3327127G	TRANSISTOR	2SC2712GR TE85R	
Q 2054	G3327127G	TRANSISTOR	2SC2712GR TE85R	
Q 2055	G3327127G	TRANSISTOR	2SC2712GR TE85R	
Q 2056	G3327127G	TRANSISTOR	2SC2712GR TE85R	
Q 2057	G1090988	IC	M5223L	
Q 2058	G3070006	TRANSISTOR	FA1A4P-T2B	
Q 2059	G3327127G	TRANSISTOR	2SC2712GR TE85R	
Q 2060	G3327127G	TRANSISTOR	2SC2712GR TE85R	
Q 2061	G3070011	TRANSISTOR	FN1A4P-T2B	
Q 2062	G3070006	TRANSISTOR	FA1A4P-T2B	
Q 2063	G3070011	TRANSISTOR	FN1A4P-T2B	
Q 2064	G3070006	TRANSISTOR	FA1A4P-T2B	
Q 2065	G3070006	TRANSISTOR	FA1A4P-T2B	
Q 2066	G3070006	TRANSISTOR	FA1A4P-T2B	
Q 2067	G3070006	TRANSISTOR	FA1A4P-T2B	
Q 2068	G3070006	TRANSISTOR	FA1A4P-T2B	
Q 2069	G3070006	TRANSISTOR	FA1A4P-T2B	
R 2001	J24205104	CHIP RES.	RMC1/10T 104J	100K 1/10W
R 2002	J24205104	CHIP RES.	RMC1/10T 104J	100K 1/10W
R 2004	J24205101	CHIP RES.	RMC1/10T 101J	100 1/10W
R 2005	J24205881	CHIP RES.	RMC1/10T 681J	680 1/10W
R 2006	J24205471	CHIP RES.	RMC1/10T 471J	470 1/10W
R 2007	J24205472	CHIP RES.	RMC1/10T 472J	4.7K 1/10W
R 2008	J24205222	CHIP RES.	RMC1/10T 222J	2.2K 1/10W
R 2009	J24205102	CHIP RES.	RMC1/10T 102J	1K 1/10W
R 2010	J24205102	CHIP RES.	RMC1/10T 102J	1K 1/10W
R 2011	J24205102	CHIP RES.	RMC1/10T 102J	1K 1/10W
R 2012	J24205473	CHIP RES.	RMC1/10T 473J	47K 1/10W
R 2013	J24205221	CHIP RES.	RMC1/10T 221J	220 1/10W
R 2014	J24205101	CHIP RES.	RMC1/10T 101J	100 1/10W

For Service Manuals Contact
MAURITRON TECHNICAL SERVICES
 8 Cherry Tree Rd, Chinnor
 Oxon OX9 4QY
 Tel: 01844-351694 Fax: 01844-352554
 Email: enquiries@mauritron.co.uk

IF Unit Parts List

ADD	CODE NO	DESCRIPTION	DEVICE	TYP	VAL
R 2015	J24205103	CHIP RES.	RMC1/10T 103J	10K	1/10W
R 2016	J24205683	CHIP RES.	RMC1/10T 683J	68K	1/10W
R 2017	J24205102	CHIP RES.	RMC1/10T 102J	1K	1/10W
R 2018	J24205101	CHIP RES.	RMC1/10T 101J	100	1/10W
R 2019	J24205103	CHIP RES.	RMC1/10T 103J	10K	1/10W
R 2020	J24205101	CHIP RES.	RMC1/10T 101J	100	1/10W
R 2021	J24205104	CHIP RES.	RMC1/10T 104J	100K	1/10W
R 2022	J24205101	CHIP RES.	RMC1/10T 101J	100	1/10W
R 2023	J24205102	CHIP RES.	RMC1/10T 102J	1K	1/10W
R 2024	J24205103	CHIP RES.	RMC1/10T 103J	10K	1/10W
R 2025	J24205153	CHIP RES.	RMC1/10T 153J	15K	1/10W
R 2026	J24205154	CHIP RES.	RMC1/10T 154J	150K	1/10W
R 2027	J24205334	CHIP RES.	RMC1/10T 334J	330K	1/10W
R 2028	J24205682	CHIP RES.	RMC1/10T 682J	6.8K	1/10W
R 2029	J24205102	CHIP RES.	RMC1/10T 102J	1K	1/10W
R 2030	J24205473	CHIP RES.	RMC1/10T 473J	47K	1/10W
R 2031	J24205473	CHIP RES.	RMC1/10T 473J	47K	1/10W
R 2032	J24205683	CHIP RES.	RMC1/10T 683J	68K	1/10W
R 2034	J24205102	CHIP RES.	RMC1/10T 102J	1K	1/10W
R 2035	J24205103	CHIP RES.	RMC1/10T 103J	10K	1/10W
R 2036	J24205472	CHIP RES.	RMC1/10T 472J	4.7K	1/10W
R 2037	J24205472	CHIP RES.	RMC1/10T 472J	4.7K	1/10W
R 2038	J24205103	CHIP RES.	RMC1/10T 103J	10K	1/10W
R 2039	J24205473	CHIP RES.	RMC1/10T 473J	47K	1/10W
R 2040	J24205154	CHIP RES.	RMC1/10T 154J	150K	1/10W
R 2041	J24205101	CHIP RES.	RMC1/10T 101J	100	1/10W
R 2042	J24205101	CHIP RES.	RMC1/10T 101J	100	1/10W
R 2043	J24205101	CHIP RES.	RMC1/10T 101J	100	1/10W
R 2044	J24205101	CHIP RES.	RMC1/10T 101J	100	1/10W
R 2045	J24205101	CHIP RES.	RMC1/10T 101J	100	1/10W
R 2046	J24205101	CHIP RES.	RMC1/10T 101J	100	1/10W
R 2047	J24205101	CHIP RES.	RMC1/10T 101J	100	1/10W
R 2048	J24205101	CHIP RES.	RMC1/10T 101J	100	1/10W
R 2049	J24205271	CHIP RES.	RMC1/10T 271J	270	1/10W
R 2050	J24205271	CHIP RES.	RMC1/10T 271J	270	1/10W
R 2051	J24205331	CHIP RES.	RMC1/10T 331J	330	1/10W
R 2052	J24205681	CHIP RES.	RMC1/10T 681J	680	1/10W
R 2053	J24205103	CHIP RES.	RMC1/10T 103J	10K	1/10W
R 2054	J24205223	CHIP RES.	RMC1/10T 223J	22K	1/10W
R 2060	J24205102	CHIP RES.	RMC1/10T 102J	1K	1/10W
R 2062	J24205331	CHIP RES.	RMC1/10T 331J	330	1/10W
R 2064	J24205102	CHIP RES.	RMC1/10T 102J	1K	1/10W
R 2065	J24205221	CHIP RES.	RMC1/10T 221J	220	1/10W
R 2066	J24205472	CHIP RES.	RMC1/10T 472J	4.7K	1/10W
R 2067	J24205101	CHIP RES.	RMC1/10T 101J	100	1/10W
R 2068	J24205101	CHIP RES.	RMC1/10T 101J	100	1/10W
R 2069	J24205472	CHIP RES.	RMC1/10T 472J	4.7K	1/10W
R 2070	J24205101	CHIP RES.	RMC1/10T 101J	100	1/10W
R 2071	J24205101	CHIP RES.	RMC1/10T 101J	100	1/10W
R 2072	J24205472	CHIP RES.	RMC1/10T 472J	4.7K	1/10W
R 2073	J24205101	CHIP RES.	RMC1/10T 101J	100	1/10W
R 2074	J24205101	CHIP RES.	RMC1/10T 101J	100	1/10W
R 2075	J24205472	CHIP RES.	RMC1/10T 472J	4.7K	1/10W
R 2076	J24205101	CHIP RES.	RMC1/10T 101J	100	1/10W
R 2077	J24205101	CHIP RES.	RMC1/10T 101J	100	1/10W
R 2078	J24205332	CHIP RES.	RMC1/10T 332J	3.3K	1/10W
R 2079	J24205101	CHIP RES.	RMC1/10T 101J	100	1/10W
R 2080	J24205101	CHIP RES.	RMC1/10T 101J	100	1/10W
R 2081	J24205472	CHIP RES.	RMC1/10T 472J	4.7K	1/10W
R 2082	J24205472	CHIP RES.	RMC1/10T 472J	4.7K	1/10W
R 2083	J24205472	CHIP RES.	RMC1/10T 472J	4.7K	1/10W
R 2084	J24205472	CHIP RES.	RMC1/10T 472J	4.7K	1/10W
R 2085	J24205332	CHIP RES.	RMC1/10T 332J	3.3K	1/10W
R 2090	J24205221	CHIP RES.	RMC1/10T 221J	220	1/10W
R 2092	J24205473	CHIP RES.	RMC1/10T 473J	47K	1/10W
R 2093	J24205153	CHIP RES.	RMC1/10T 153J	15K	1/10W
R 2094	J24205331	CHIP RES.	RMC1/10T 331J	330	1/10W
R 2095	J24205102	CHIP RES.	RMC1/10T 102J	1K	1/10W
R 2097	J24205101	CHIP RES.	RMC1/10T 101J	100	1/10W
R 2098	J24205103	CHIP RES.	RMC1/10T 103J	10K	1/10W
R 2099	J24205473	CHIP RES.	RMC1/10T 473J	47K	1/10W
R 2100	J24205823	CHIP RES.	RMC1/10T 823J	82K	1/10W
R 2101	J24205560	CHIP RES.	RMC1/10T 560J	56	1/10W
R 2102	J24205473	CHIP RES.	RMC1/10T 473J	47K	1/10W
R 2103	J24205471	CHIP RES.	RMC1/10T 471J	470	1/10W
R 2104	J24205472	CHIP RES.	RMC1/10T 472J	4.7K	1/10W
R 2105	J24205101	CHIP RES.	RMC1/10T 101J	100	1/10W
R 2106	J24205102	CHIP RES.	RMC1/10T 102J	1K	1/10W
R 2107	J24205222	CHIP RES.	RMC1/10T 222J	2.2K	1/10W
R 2108	J24205393	CHIP RES.	RMC1/10T 393J	39K	1/10W
R 2109	J24205472	CHIP RES.	RMC1/10T 472J	4.7K	1/10W
R 2110	J24205473	CHIP RES.	RMC1/10T 473J	47K	1/10W
R 2111	J24205683	CHIP RES.	RMC1/10T 683J	68K	1/10W

IF Unit Parts List

ADD	CODE NO	DESCRIPTION	DEVICE	TYP	VAL
R 2112	J24205102	CHIP RES.	RMC1/10T 102J	1K	1/10W
R 2113	J24205101	CHIP RES.	RMC1/10T 101J	100	1/10W
R 2116	J24205102	CHIP RES.	RMC1/10T 102J	1K	1/10W
R 2117	J24205333	CHIP RES.	RMC1/10T 333J	33K	1/10W
R 2118	J24205151	CHIP RES.	RMC1/10T 151J	150	1/10W
R 2119	J24205472	CHIP RES.	RMC1/10T 472J	4.7K	1/10W
R 2120	J24205101	CHIP RES.	RMC1/10T 101J	100	1/10W
R 2121	J24205101	CHIP RES.	RMC1/10T 101J	100	1/10W
R 2122	J24205104	CHIP RES.	RMC1/10T 104J	100K	1/10W
R 2123	J24205103	CHIP RES.	RMC1/10T 103J	10K	1/10W
R 2124	J24205101	CHIP RES.	RMC1/10T 101J	100	1/10W
R 2125	J24205102	CHIP RES.	RMC1/10T 102J	1K	1/10W
R 2126	J24205221	CHIP RES.	RMC1/10T 221J	220	1/10W
R 2127	J24205154	CHIP RES.	RMC1/10T 154J	150K	1/10W
R 2128	J24205222	CHIP RES.	RMC1/10T 222J	2.2K	1/10W
R 2129	J24205222	CHIP RES.	RMC1/10T 222J	2.2K	1/10W
R 2130	J24205473	CHIP RES.	RMC1/10T 473J	47K	1/10W
R 2131	J24205152	CHIP RES.	RMC1/10T 152J	1.5K	1/10W
R 2132	J24205332	CHIP RES.	RMC1/10T 332J	3.3K	1/10W
R 2133	J24205152	CHIP RES.	RMC1/10T 152J	1.5K	1/10W
R 2134	J24205153	CHIP RES.	RMC1/10T 153J	15K	1/10W
R 2135	J24205334	CHIP RES.	RMC1/10T 334J	330K	1/10W
R 2136	J24205102	CHIP RES.	RMC1/10T 102J	1K	1/10W
R 2137	J24205472	CHIP RES.	RMC1/10T 472J	4.7K	1/10W
R 2138	J24205103	CHIP RES.	RMC1/10T 103J	10K	1/10W
R 2139	J24205101	CHIP RES.	RMC1/10T 101J	100	1/10W
R 2140	J24205103	CHIP RES.	RMC1/10T 103J	10K	1/10W
R 2141	J24205103	CHIP RES.	RMC1/10T 103J	10K	1/10W
R 2142	J24205102	CHIP RES.	RMC1/10T 102J	1K	1/10W
R 2143	J24205103	CHIP RES.	RMC1/10T 103J	10K	1/10W
R 2145	J24205104	CHIP RES.	RMC1/10T 104J	100K	1/10W
R 2146	J24205102	CHIP RES.	RMC1/10T 102J	1K	1/10W
R 2147	J24205334	CHIP RES.	RMC1/10T 334J	330K	1/10W
R 2148	J24205221	CHIP RES.	RMC1/10T 221J	220	1/10W
R 2149	J24205155	CHIP RES.	RMC1/10T 155J	1.5M	1/10W
R 2150	J24205222	CHIP RES.	RMC1/10T 222J	2.2K	1/10W
R 2151	J24205101	CHIP RES.	RMC1/10T 101J	100	1/10W
R 2152	J24205153	CHIP RES.	RMC1/10T 153J	15K	1/10W
R 2153	J24205100	CHIP RES.	RMC1/10T 100J	10	1/10W
R 2154	J24205102	CHIP RES.	RMC1/10T 102J	1K	1/10W
R 2155	J24205102	CHIP RES.	RMC1/10T 102J	1K	1/10W
R 2156	J24205104	CHIP RES.	RMC1/10T 104J	100K	1/10W
R 2157	J24205104	CHIP RES.	RMC1/10T 104J	100K	1/10W
R 2160	J24205473	CHIP RES.	RMC1/10T 473J	47K	1/10W
R 2161	J24205473	CHIP RES.	RMC1/10T 473J	47K	1/10W
R 2162	J24205222	CHIP RES.	RMC1/10T 222J	2.2K	1/10W
R 2164	J24205154	CHIP RES.	RMC1/10T 154J	150K	1/10W
R 2165	J24205472	CHIP RES.	RMC1/10T 472J	4.7K	1/10W
R 2166	J24205104	CHIP RES.	RMC1/10T 104J	100K	1/10W
R 2167	J24205104	CHIP RES.	RMC1/10T 104J	100K	1/10W
R 2168	J24205104	CHIP RES.	RMC1/10T 104J	100K	1/10W
R 2169	J24205104	CHIP RES.	RMC1/10T 104J	100K	1/10W
R 2170	J24205103	CHIP RES.	RMC1/10T 103J	10K	1/10W
R 2171	J24205101	CHIP RES.	RMC1/10T 101J	100	1/10W
R 2173	J24205104	CHIP RES.	RMC1/10T 104J	100K	1/10W
R 2174	J24205104	CHIP RES.	RMC1/10T 104J	100K	1/10W
R 2176	J24205101	CHIP RES.	RMC1/10T 101J	100	1/10W
R 2177	J24205681	CHIP RES.	RMC1/10T 681J	680	1/10W
R 2179	J24205821	CHIP RES.	RMC1/10T 821J	820	1/10W
R 2180	J24205222	CHIP RES.	RMC1/10T 222J	2.2K	1/10W
R 2181	J24205102	CHIP RES.	RMC1/10T 102J	1K	1/10W
R 2182	J24205102	CHIP RES.	RMC1/10T 102J	1K	1/10W
R 2184	J24205681	CHIP RES.	RMC1/10T 681J	680	1/10W
R 2185	J24205331	CHIP RES.	RMC1/10T 331J	330	1/10W
R 2186	J24205471	CHIP RES.	RMC1/10T 471J	470	1/10W
R 2191	J24205101	CHIP RES.	RMC1/10T 101J	100	1/10W
R 2192	J24205331	CHIP RES.	RMC1/10T 331J	330	1/10W
R 2193	J24205683	CHIP RES.	RMC1/10T 683J	68K	1/10W
R 2194	J24205222	CHIP RES.	RMC1/10T 222J	2.2K	1/10W
R 2195	J24205102	CHIP RES.	RMC1/10T 102J	1K	1/10W
R 2196	J24205102	CHIP RES.	RMC1/10T 102J	1K	1/10W
R 2197	J24205221	CHIP RES.	RMC1/10T 221J	220	1/10W
R 2198	J24205101	CHIP RES.	RMC1/10T 101J	100	1/10W
R 2200	J24205101	CHIP RES.	RMC1/10T 101J	100	1/10W
R 2202	J24205331	CHIP RES.	RMC1/10T 331J	330	1/10W
R 2203	J24205102	CHIP RES.	RMC1/10T 102J	1K	1/10W
R 2204	J24205473	CHIP RES.	RMC1/10T 473J	47K	1/10W
R 2205	J24205103	CHIP RES.	RMC1/10T 103J	10K	1/10W
R 2206	J24205102	CHIP RES.	RMC1/10T 102J	1K	1/10W
R 2207	J24205222	CHIP RES.	RMC1/10T 222J	2.2K	1/10W
R 2208	J24205471	CHIP RES.	RMC1/10T 471J	470	1/10W
R 2209	J24205101	CHIP RES.	RMC1/10T 101J	100	1/10W
R 2210	J24205104	CHIP RES.	RMC1/10T 104J	100K	1/10W

For Service Manuals Contact
MAURITRON TECHNICAL SERVICES
 8 Cherry Tree Rd, Chimbor
 Oxon OX9 4QY
 Tel: 01844-351694 Fax: 01844-352554
 Email: enquiries@mauritron.co.uk

IF Unit Parts List

ADD	CODE NO	DESCRIPTION	DEVICE	TYP	VAL
R 2211	J24205103	CHIP RES.	RMC1/10T 103J	10K	1/10W
R 2212	J24205103	CHIP RES.	RMC1/10T 103J	10K	1/10W
R 2213	J24205392	CHIP RES.	RMC1/10T 392J	3.9K	1/10W
R 2214	J24205682	CHIP RES.	RMC1/10T 682J	6.8K	1/10W
R 2215	J24205105	CHIP RES.	RMC1/10T 105J	1M	1/10W
R 2216	J24205104	CHIP RES.	RMC1/10T 104J	100K	1/10W
R 2217	J24205101	CHIP RES.	RMC1/10T 101J	100	1/10W
R 2218	J24205683	CHIP RES.	RMC1/10T 683J	68K	1/10W
R 2219	J24205101	CHIP RES.	RMC1/10T 101J	100	1/10W
R 2220	J24205682	CHIP RES.	RMC1/10T 682J	6.8K	1/10W
R 2221	J24205473	CHIP RES.	RMC1/10T 473J	47K	1/10W
R 2222	J24205221	CHIP RES.	RMC1/10T 221J	220	1/10W
R 2223	J24205151	CHIP RES.	RMC1/10T 151J	150	1/10W
R 2224	J24205332	CHIP RES.	RMC1/10T 332J	3.3K	1/10W
R 2225	J24205821	CHIP RES.	RMC1/10T 821J	820	1/10W
R 2226	J24205223	CHIP RES.	RMC1/10T 223J	22K	1/10W
R 2227	J24205103	CHIP RES.	RMC1/10T 103J	10K	1/10W
R 2228	J24205471	CHIP RES.	RMC1/10T 471J	470	1/10W
R 2229	J24205103	CHIP RES.	RMC1/10T 103J	10K	1/10W
R 2230	J24205101	CHIP RES.	RMC1/10T 101J	100	1/10W
R 2231	J24205104	CHIP RES.	RMC1/10T 104J	100K	1/10W
R 2232	J24205471	CHIP RES.	RMC1/10T 471J	470	1/10W
R 2233	J24205101	CHIP RES.	RMC1/10T 101J	100	1/10W
R 2234	J24205151	CHIP RES.	RMC1/10T 151J	150	1/10W
R 2235	J24205560	CHIP RES.	RMC1/10T 560J	56	1/10W
R 2236	J24205104	CHIP RES.	RMC1/10T 104J	100K	1/10W
R 2237	J24205101	CHIP RES.	RMC1/10T 101J	100	1/10W
R 2238	J24205471	CHIP RES.	RMC1/10T 471J	470	1/10W
R 2239	J24205331	CHIP RES.	RMC1/10T 331J	330	1/10W
R 2240	J24205223	CHIP RES.	RMC1/10T 223J	22K	1/10W
R 2241	J24205103	CHIP RES.	RMC1/10T 103J	10K	1/10W
R 2242	J24205471	CHIP RES.	RMC1/10T 471J	470	1/10W
R 2243	J24205103	CHIP RES.	RMC1/10T 103J	10K	1/10W
R 2244	J24205101	CHIP RES.	RMC1/10T 101J	100	1/10W
R 2246	J24205101	CHIP RES.	RMC1/10T 101J	100	1/10W
R 2247	J24205102	CHIP RES.	RMC1/10T 102J	1K	1/10W
R 2248	J24205473	CHIP RES.	RMC1/10T 473J	47K	1/10W
R 2249	J24205223	CHIP RES.	RMC1/10T 223J	22K	1/10W
R 2250	J24205471	CHIP RES.	RMC1/10T 471J	470	1/10W
R 2251	J24205101	CHIP RES.	RMC1/10T 101J	100	1/10W
R 2252	J24205223	CHIP RES.	RMC1/10T 223J	22K	1/10W
R 2253	J24205103	CHIP RES.	RMC1/10T 103J	10K	1/10W
R 2256	J24205104	CHIP RES.	RMC1/10T 104J	100K	1/10W
R 2257	J24205104	CHIP RES.	RMC1/10T 104J	100K	1/10W
R 2258	J24205103	CHIP RES.	RMC1/10T 103J	10K	1/10W
R 2259	J24205332	CHIP RES.	RMC1/10T 332J	3.3K	1/10W
R 2260	J24205103	CHIP RES.	RMC1/10T 103J	10K	1/10W
R 2261	J24205102	CHIP RES.	RMC1/10T 102J	1K	1/10W
R 2262	J24205472	CHIP RES.	RMC1/10T 472J	4.7K	1/10W
R 2263	J24205472	CHIP RES.	RMC1/10T 472J	4.7K	1/10W
R 2264	J24205103	CHIP RES.	RMC1/10T 103J	10K	1/10W
R 2266	J24205103	CHIP RES.	RMC1/10T 103J	10K	1/10W
R 2267	J24205103	CHIP RES.	RMC1/10T 103J	10K	1/10W
R 2268	J24205104	CHIP RES.	RMC1/10T 104J	100K	1/10W
R 2269	J24205151	CHIP RES.	RMC1/10T 151J	150	1/10W
R 2270	J24205101	CHIP RES.	RMC1/10T 101J	100	1/10W
R 2271	J24205104	CHIP RES.	RMC1/10T 104J	100K	1/10W
R 2272	J24205151	CHIP RES.	RMC1/10T 151J	150	1/10W
R 2273	J24205101	CHIP RES.	RMC1/10T 101J	100	1/10W
R 2274	J24205102	CHIP RES.	RMC1/10T 102J	1K	1/10W
R 2275	J24205221	CHIP RES.	RMC1/10T 221J	220	1/10W
R 2276	J24205104	CHIP RES.	RMC1/10T 104J	100K	1/10W
R 2277	J24205104	CHIP RES.	RMC1/10T 104J	100K	1/10W
R 2278	J24205222	CHIP RES.	RMC1/10T 222J	2.2K	1/10W
R 2279	J24205104	CHIP RES.	RMC1/10T 104J	100K	1/10W
R 2280	J24205104	CHIP RES.	RMC1/10T 104J	100K	1/10W
R 2282	J24205471	CHIP RES.	RMC1/10T 471J	470	1/10W
R 2284	J24205471	CHIP RES.	RMC1/10T 471J	470	1/10W
R 2285	J24205221	CHIP RES.	RMC1/10T 221J	220	1/10W
R 2286	J24205104	CHIP RES.	RMC1/10T 104J	100K	1/10W
R 2288	J24205471	CHIP RES.	RMC1/10T 471J	470	1/10W
R 2289	J24205223	CHIP RES.	RMC1/10T 223J	22K	1/10W
R 2290	J24205182	CHIP RES.	RMC1/10T 182J	1.8K	1/10W
R 2291	J24205102	CHIP RES.	RMC1/10T 102J	1K	1/10W
R 2292	J24205104	CHIP RES.	RMC1/10T 104J	100K	1/10W
R 2293	J24205153	CHIP RES.	RMC1/10T 153J	15K	1/10W
R 2294	J24205223	CHIP RES.	RMC1/10T 223J	22K	1/10W
R 2296	J24205101	CHIP RES.	RMC1/10T 101J	100	1/10W
R 2297	J24205103	CHIP RES.	RMC1/10T 103J	10K	1/10W
R 2298	J24205103	CHIP RES.	RMC1/10T 103J	10K	1/10W
R 2300	J24205000	CHIP RES.	RMC1/10T 000J	0	1/10W
R 2301	J24205000	CHIP RES.	RMC1/10T 000J	0	1/10W

IF Unit Parts List

ADD	CODE NO	DESCRIPTION	DEVICE	TYP	VAL
R 2303	J24205472	CHIP RES.	RMC1/10T 472J	4.7K	1/10W
R 2304	J24205102	CHIP RES.	RMC1/10T 102J	1K	1/10W
R 2305	J24205560	CHIP RES.	RMC1/10T 560J	56	1/10W
R 2306	J24205221	CHIP RES.	RMC1/10T 221J	220	1/10W
R 2307	J24205103	CHIP RES.	RMC1/10T 103J	10K	1/10W
R 2308	J24205103	CHIP RES.	RMC1/10T 103J	10K	1/10W
R 2309	J24205103	CHIP RES.	RMC1/10T 103J	10K	1/10W
R 2310	J24205103	CHIP RES.	RMC1/10T 103J	10K	1/10W
R 2311	J24205103	CHIP RES.	RMC1/10T 103J	10K	1/10W
R 2312	J24205103	CHIP RES.	RMC1/10T 103J	10K	1/10W
R 2313	J24205103	CHIP RES.	RMC1/10T 103J	10K	1/10W
R 2314	J24205103	CHIP RES.	RMC1/10T 103J	10K	1/10W
R 2315	J24205471	CHIP RES.	RMC1/10T 471J	470	1/10W
R 2316	J24205471	CHIP RES.	RMC1/10T-471J	470	1/10W
R 2317	J24205103	CHIP RES.	RMC1/10T 103J	10K	1/10W
R 2318	J24205472	CHIP RES.	RMC1/10T 472J	4.7K	1/10W
R 2319	J24205103	CHIP RES.	RMC1/10T 103J	10K	1/10W
R 2320	J24205103	CHIP RES.	RMC1/10T 103J	10K	1/10W
R 2321	J24205153	CHIP RES.	RMC1/10T 153J	15K	1/10W
R 2322	J24205681	CHIP RES.	RMC1/10T 681J	680	1/10W
R 2323	J24205101	CHIP RES.	RMC1/10T 101J	100	1/10W
R 2324	J24205101	CHIP RES.	RMC1/10T 101J	100	1/10W
R 2325	J24205102	CHIP RES.	RMC1/10T 102J	1K	1/10W
R 2326	J24205221	CHIP RES.	RMC1/10T 221J	220	1/10W
R 2327	J24205221	CHIP RES.	RMC1/10T 221J	220	1/10W
R 2328	J24205471	CHIP RES.	RMC1/10T 471J	470	1/10W
R 2329	J24205221	CHIP RES.	RMC1/10T 221J	220	1/10W
R 2330	J24205221	CHIP RES.	RMC1/10T 221J	220	1/10W
R 2331	J24205471	CHIP RES.	RMC1/10T 471J	470	1/10W
R 2332	J24205000	CHIP RES.	RMC1/10T 000J	0	1/10W
R 2333	J24205102	CHIP RES.	RMC1/10T 102J	1K	1/10W
R 2334	J24205470	CHIP RES.	RMC1/10T 470J	47	1/10W
R 2335	J24205222	CHIP RES.	RMC1/10T 222J	2.2K	1/10W
R 2336	J24205103	CHIP RES.	RMC1/10T 103J	10K	1/10W
R 2337	J24206474	CHIP RES.	RMC1/10T 474J	470K	1/10W
R 2338	J24205103	CHIP RES.	RMC1/10T 103J	10K	1/10W
R 2339	J24205224	CHIP RES.	RMC1/10T 224J	220K	1/10W
R 2340	J24205332	CHIP RES.	RMC1/10T 332J	3.3K	1/10W
T 2001	L0021961	COIL	73.62M R12-J759A		
T 2002	L0021396	COIL	8.21M R12-6368A		
T 2003	L0021199	COIL	8.20M R12-4043A		
T 2004	L0021199	COIL	8.20M R12-4043A		
T 2005	L0021199	COIL	8.20M R12-4043A		
T 2006	L0021199	COIL	8.20M R12-4043A		
T 2007	L0021396	COIL	8.21M R12-6368A		
T 2008	L0020422	COIL	R12-7947C		
T 2009	L0020422	COIL	R12-7947C		
T 2010	L0021965	COIL	R12-J763A		
T 2011	L0021966	COIL	S-135-213		
T 2012	L0020421	COIL	R12-7935A		
T 2013	L0021965	COIL	R12-J763A		
T 2014	L0021958	COIL	R12-J758A		
T 2015	L0021961	COIL	73.62M R12-J759A		
T 2016	L0021395	COIL	8.21M R12-6367A		
T 2017	L0021199	COIL	8.20M R12-4043A		
T 2018	L0021199	COIL	8.20M R12-4043A		
T 2019	L0020422	COIL	R12-7947C		
T 2020	L0020422	COIL	R12-7947C		
T 2022	L0021962	COIL	R12-J760A		
T 2023	L0021968	COIL	1-1 RID-Q5B		
T 2024	L0021968	COIL	1-1 RID-Q5B		
T 2025	L0021964	COIL	R12-J762A		
T 2026	L0021963	COIL	R12-J761A		
T 2027	L0021276	COIL	6.70U _R12-3301X		
T 2029	L0021863	COIL	31U R12-G456X		
T 2030	L0190002	COIL	455K		
TC2001	K91000086	TRIMMER CAP.	VCT51E117	20PF	20p
TC2002	K91000086	TRIMMER CAP.	VCT51E117	20PF	20p
TH2002	G9090016	THERMISTOR	112252-2		
TH2003	G9090010	THERMISTOR	112302-2		
TH2004	G9090016	THERMISTOR	112252-2		
TH2005	G9090010	THERMISTOR	112302-2		
TH2006	G9090039	THERMISTOR	112152-2		
TP2001	Q5000026	TP-F	TP-F IPS-1032		
TP2002	Q5000026	TP-F	TP-F IPS-1032		
TP2003	Q5000026	TP-F	TP-F IPS-1032		
TP2004	Q5000026	TP-F	TP-F IPS-1032		
TP2005	Q5000026	TP-F	TP-F IPS-1032		
TP2006	Q5000026	TP-F	TP-F IPS-1032		
VR2001	J51745102	POT.	H0651A007-1KB	1KB	
VR2002	J51745102	POT.	H0651A007-1KB	1KB	
VR2003	J51745473	POT.	H0651A017-47KB	47KB	
VR2004	J51745103	POT.	H0651A013-10KB	10KB	

For Service Manuals Contact
MAURITRON TECHNICAL SERVICES
 8 Cherry Tree Rd, Chinnor
 Oxon OX9 4QY
 Tel: 01844 351694 Fax: 01844 352554
 Email: enquiries@mauritron.co.uk

IF Unit Parts List

ADD	CODE NO	DESCRIPTION	DEVICE	TYP VAL
VR2005	J51745102	POT.	H0651A007-1KB	1KB
VR2006	J51745103	POT.	H0651A013-10KB	10KB
VR2007	J51745103	POT.	H0651A013-10KB	10KB
VR2008	J51745103	POT.	H0651A013-10KB	10KB
VR2009	J51745222	POT.	H0651A009-2.2KB	2.2KB
X 2001	H0102934	XTAL		8.215MHZ
X 2002	H0102936	XTAL		12.283MHZ
X 2003	H0102935	XTAL		12.280MHZ
XF2001	H1102156	XTAL	8.2M12	
XF2002	H1102157	XTAL	XF-8.2M-262-01	
XF2003	H1102158	XTAL	XF-8.2M-501-03	
D 2025	G2060004	DIODE	1SS270TJ	FLT NO
D 2032	G2060004	DIODE	1SS270TJ	FLT NO
D 2045	G2060004	DIODE	1SS270TJ	FLT NO
D 2046	G2060004	DIODE	1SS270TJ	FLT NO
D 2047	G2060004	DIODE	1SS270TJ	FLT NO

For Service Manuals Contact
MAURITRON TECHNICAL SERVICES
 8 Cherry Tree Rd, Chinnor
 Oxon OX9 4QY
 Tel:- 01844-351694 Fax:- 01844-352554
 Email:- enquiries@mauritron.co.uk

For Service Manuals Contact
MAURITRON TECHNICAL SERVICES
8 Cherry Tree Rd, Chinnor
Oxon OX9 4QY
Tel: 01844-351694 Fax: 01844-352554
Email: enquiries@mauritron.co.uk

For Service Manuals Contact
MAURITRON TECHNICAL SERVICES
8 Cherry Tree Rd, Chimbor
Oxon OX9 4QY
Tel: 01844-351634 Fax: 01844-352554
Email: enquiries@mauritron.co.uk

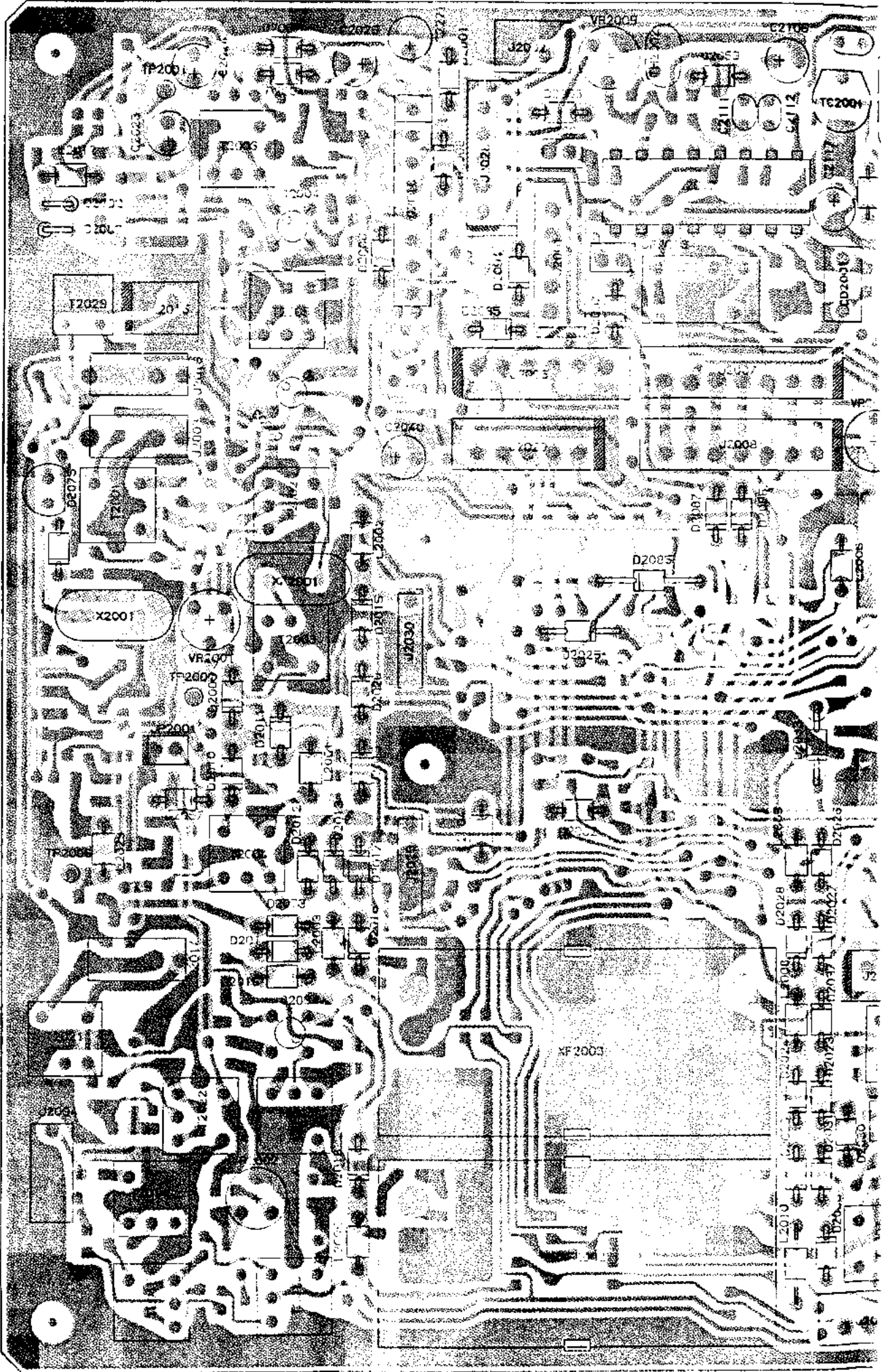

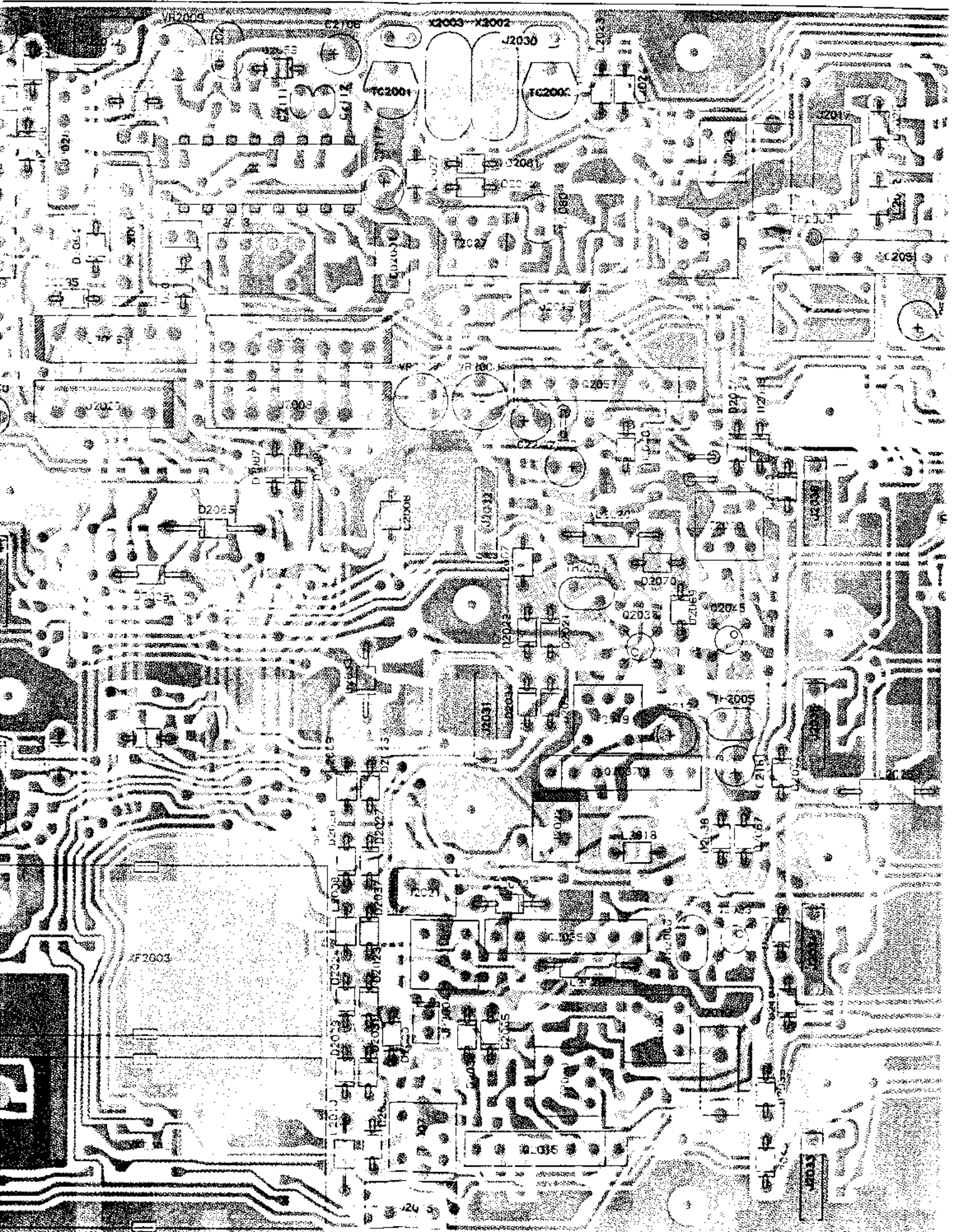

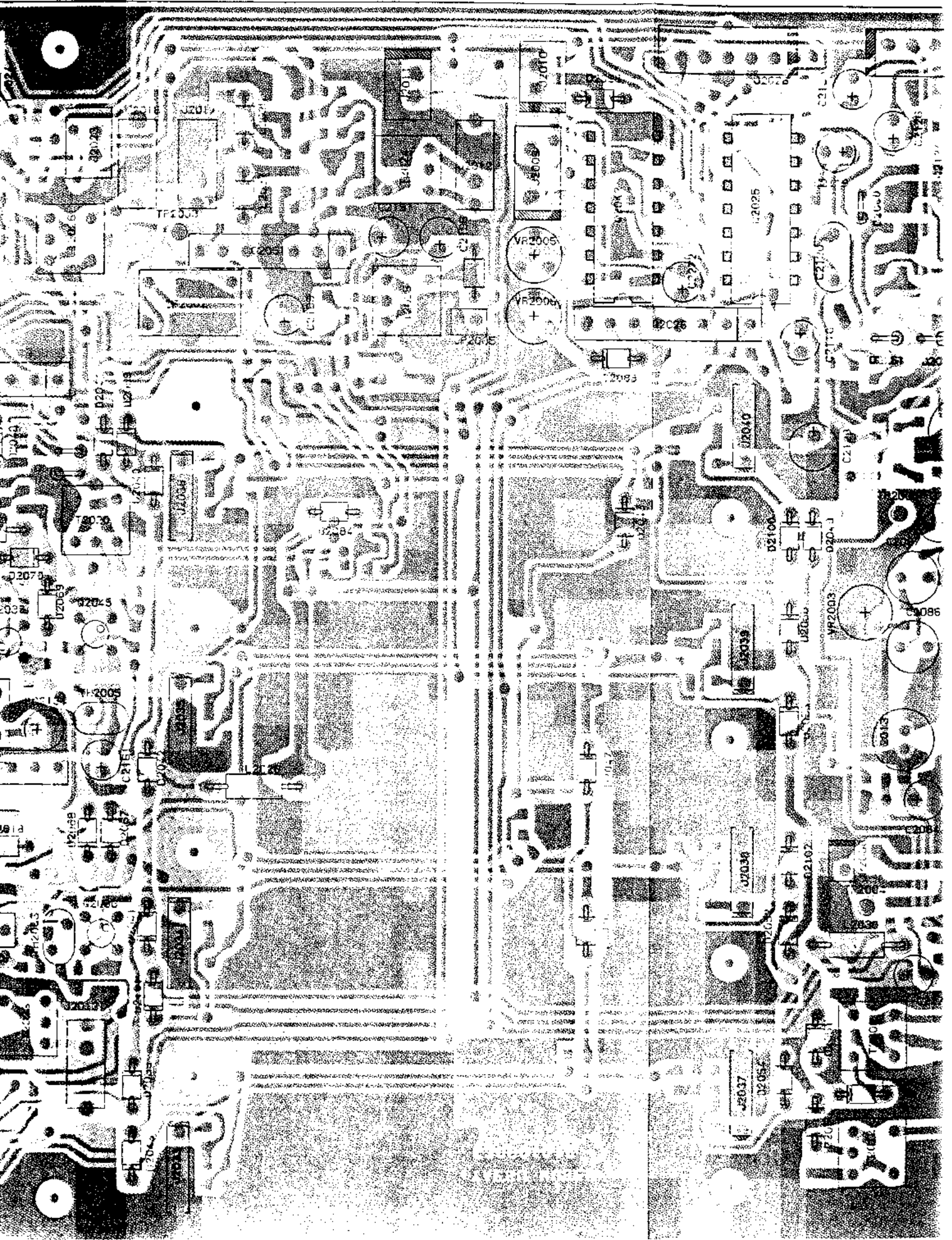

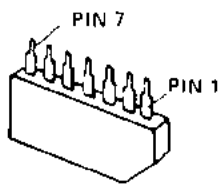
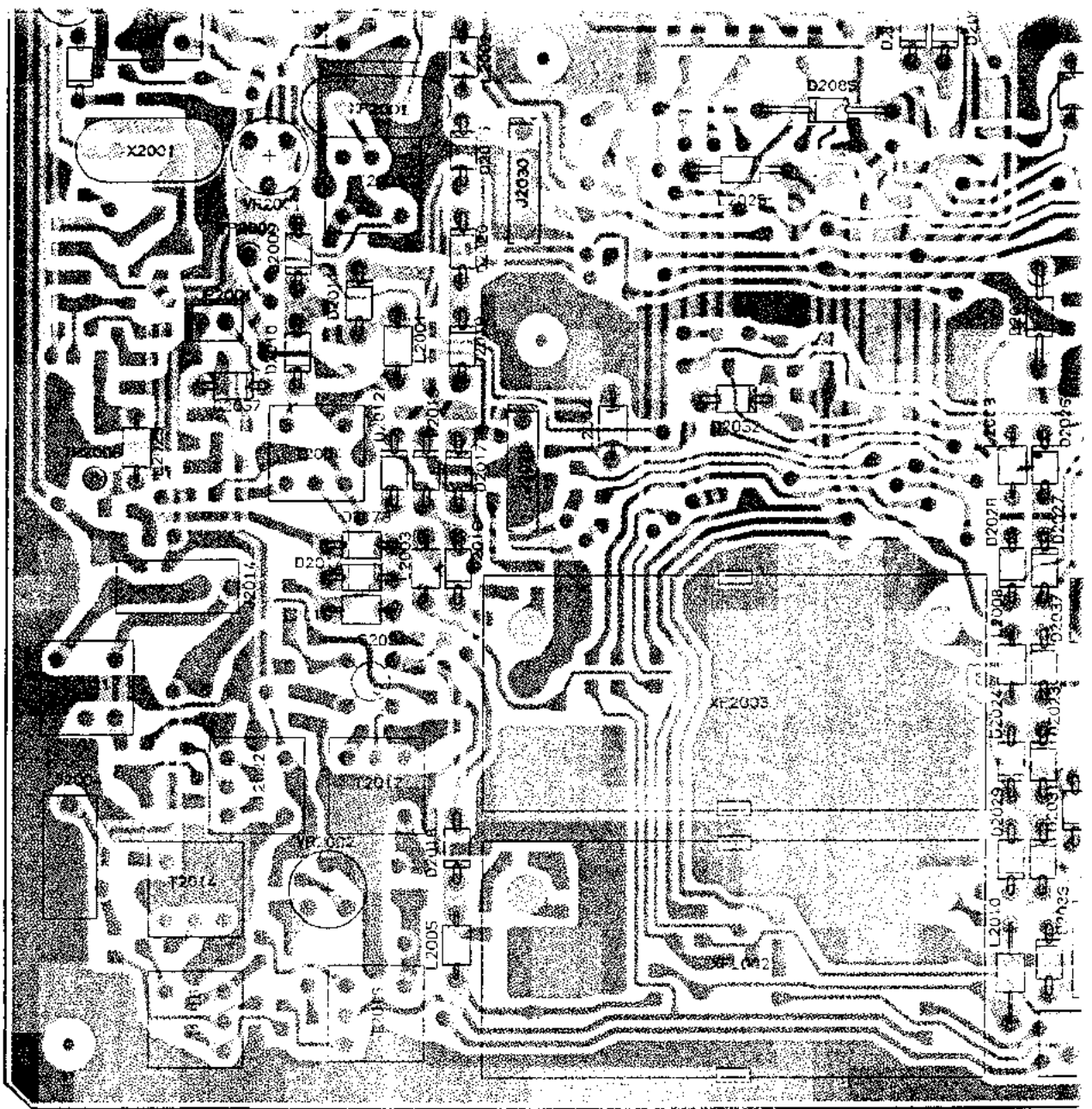

TA7302P
(Q2037)

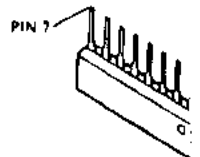

μ PC1037H
(Q2015, Q2035)

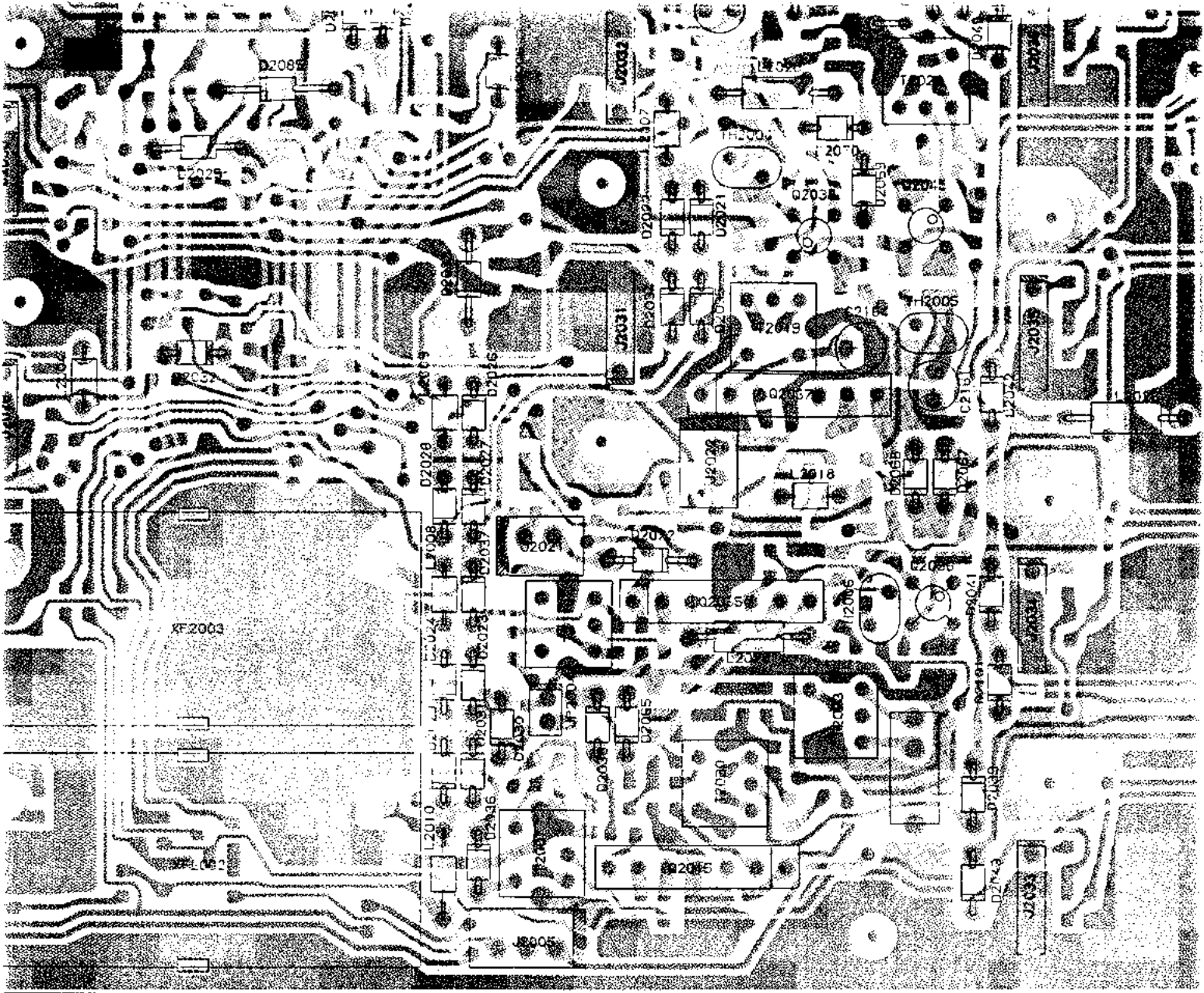

For Service Manuals Contact
MAURITRON TECHNICAL SERVICES
 8 Cherry Tree Rd, Chinnor
 Oxon OX9 4QY
 Tel: 01844-351694 Fax: 01844-352554
 Email: enquiries@mauritron.co.uk

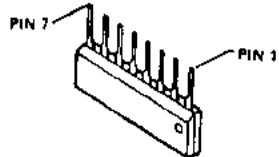

μPC1037H
 (Q2015, Q2035, Q2051)

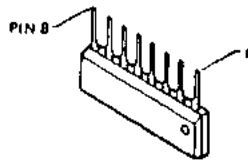

M5218L
 (Q2010, Q2026)

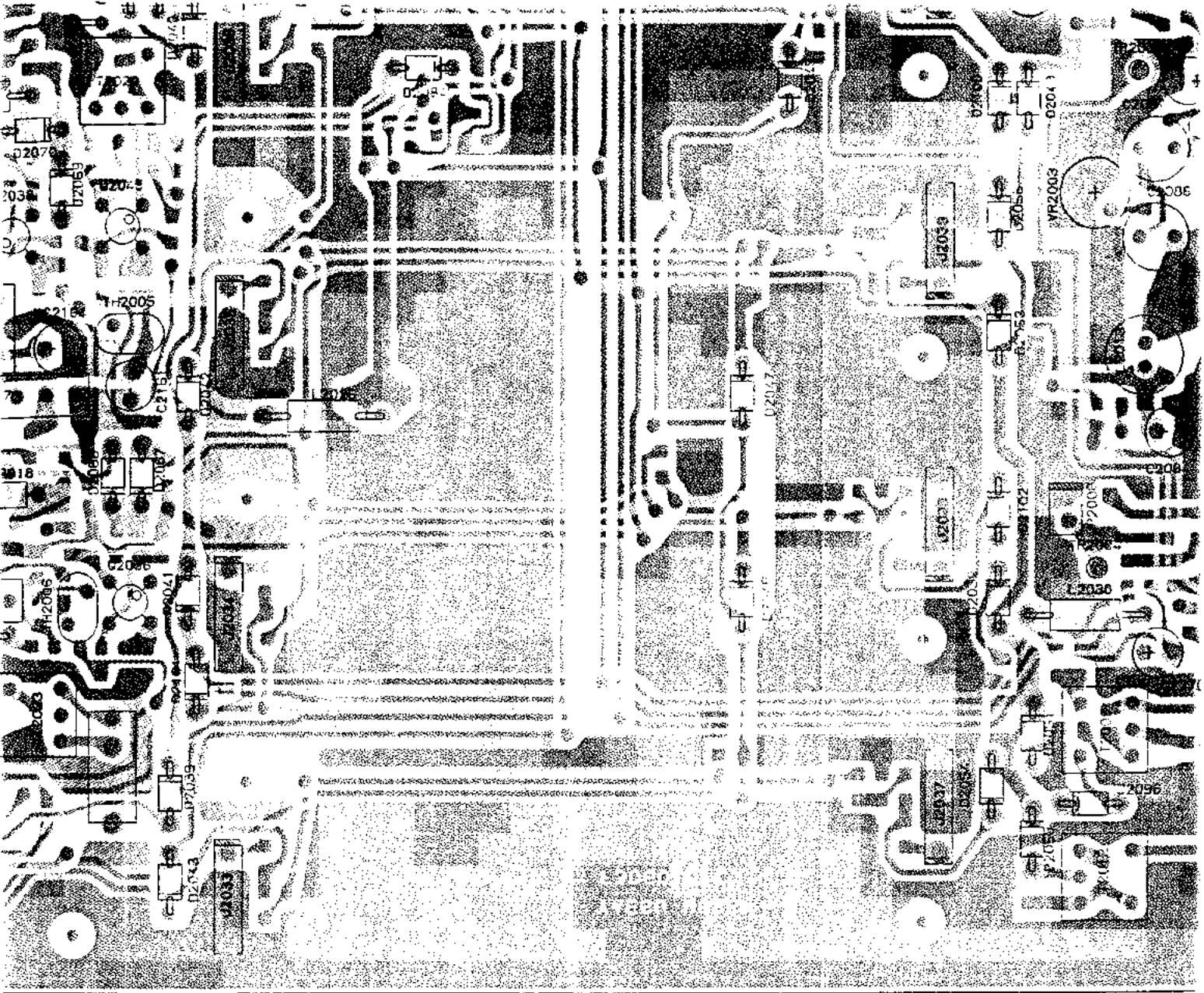

(obverse view of "compo

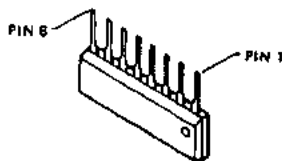

M5218L
(Q2010, Q2026)

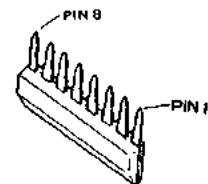

M5223L
(Q2057)

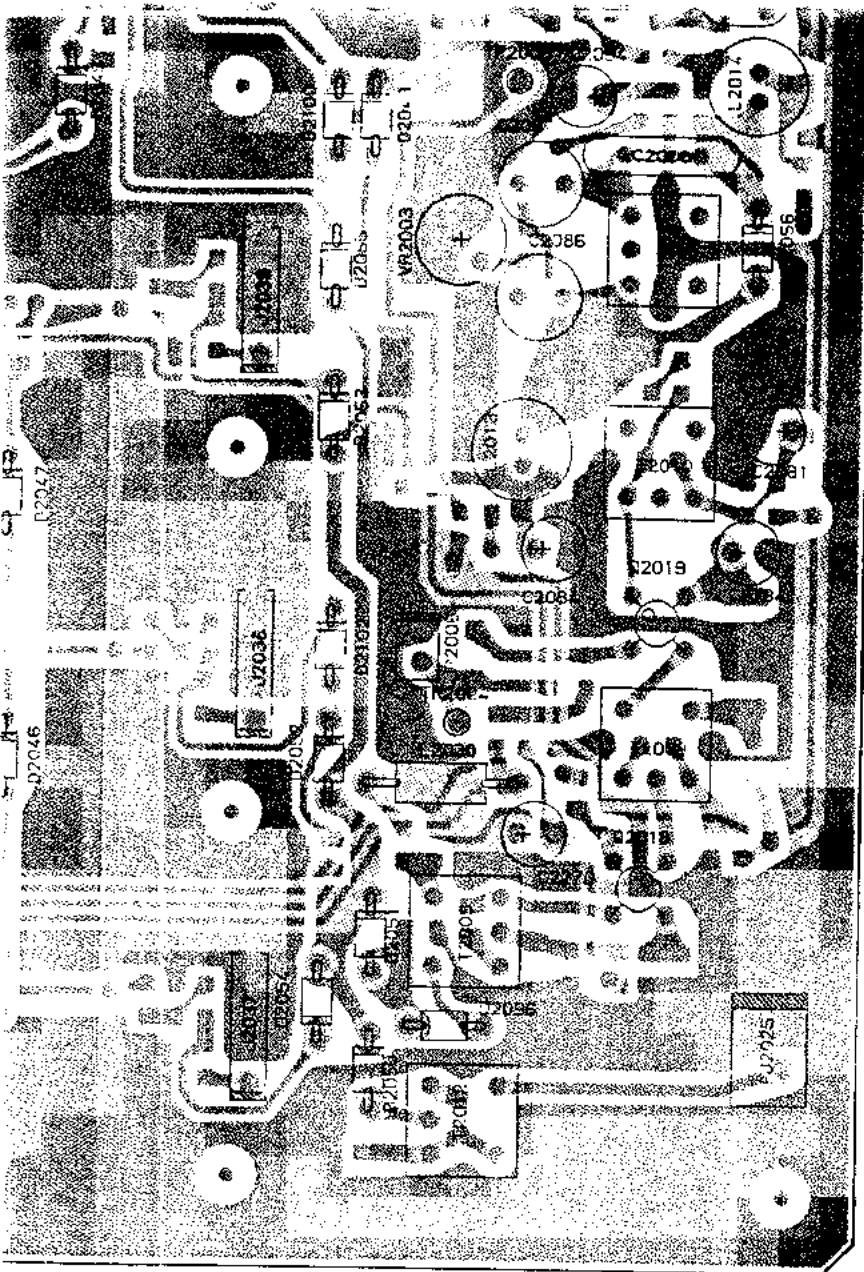

(obverse view of "component" side)

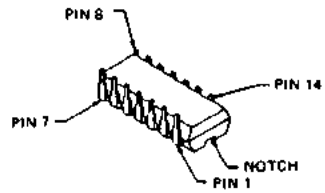

μ PD4066BC
(Q2025, Q2042)

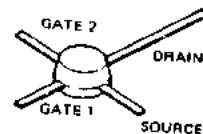

3SK74L
(Q2003, Q2004, Q2018,
Q2019, Q2024, Q2034,
Q2036, Q2038, Q2045)

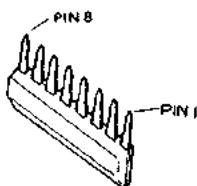

M5223L
(Q2057)

For Service Manuals Contact
MAURITRON TECHNICAL SERVICES
8 Cherry Tree Rd, Chinnor
Oxon, OX9 4QY
Tel: 01844 351694 Fax: 01844 352554
Email: enquiries@mauritron.co.uk

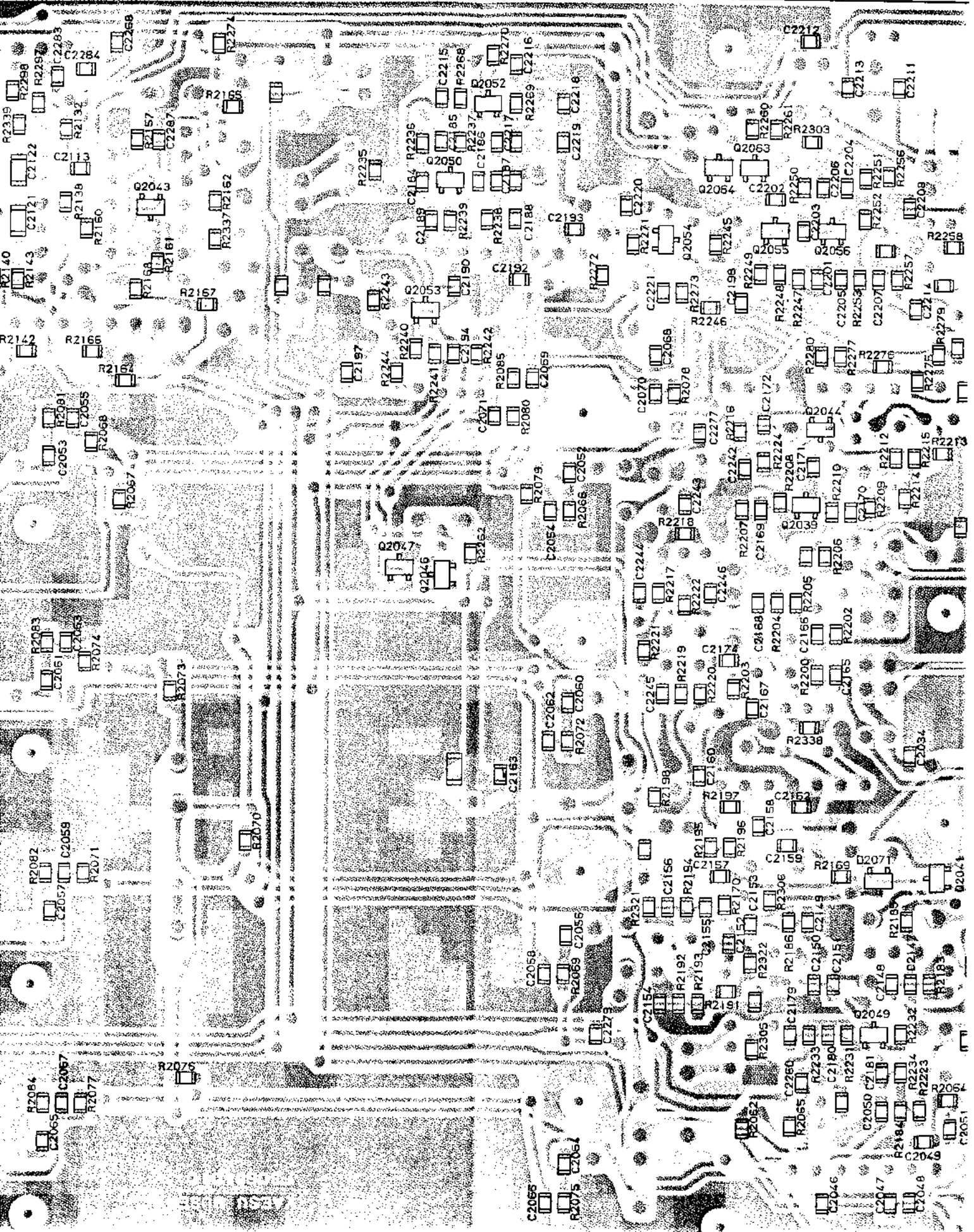

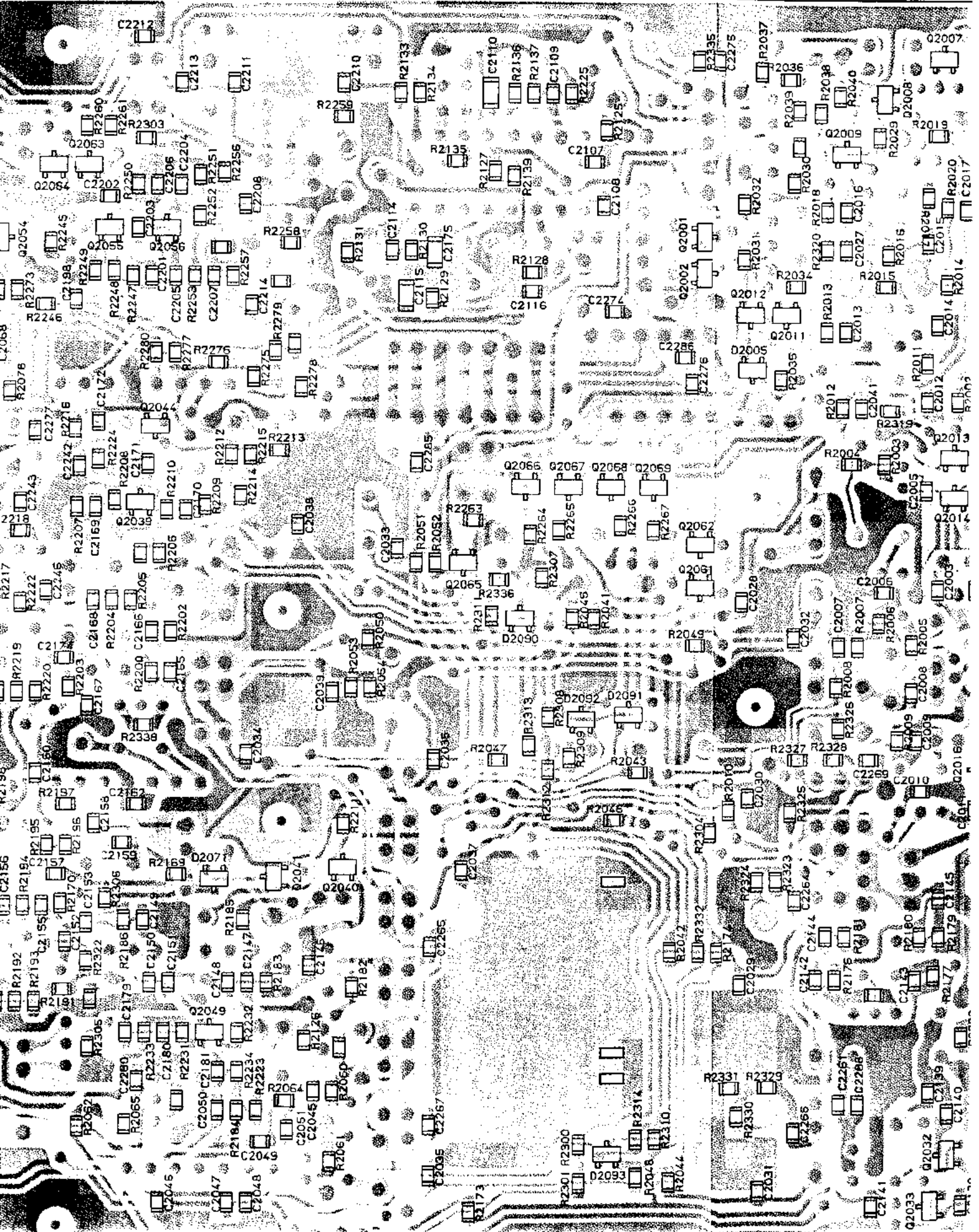

IF Unit Board Layout

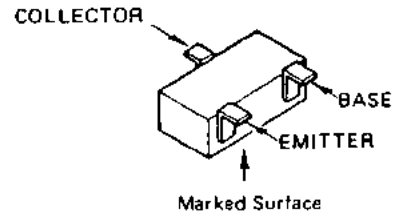
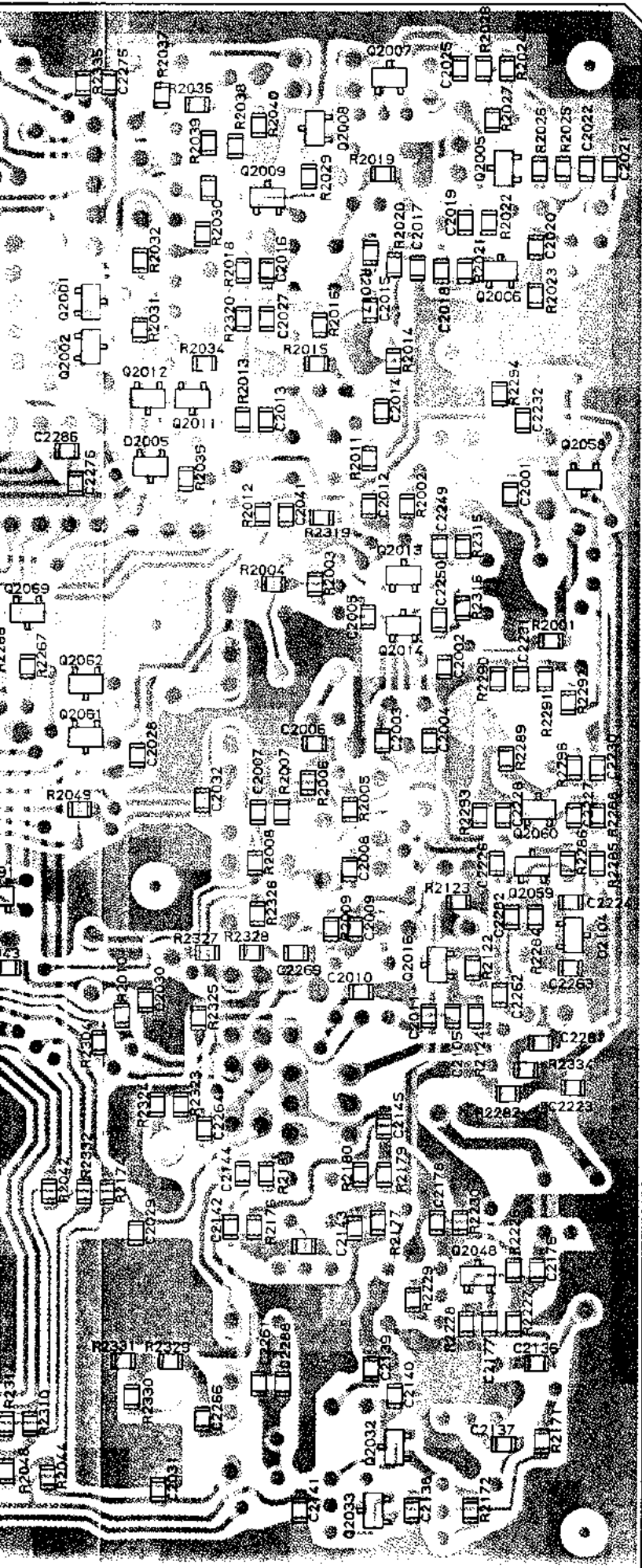

FA1A4P(L34)

(Q2001, Q2002, Q2020,
Q2030, Q2040, Q2041,
Q2043, Q2047, Q2058,
Q2062, Q2064, Q2065,
Q2066, Q2067, Q2068,
Q2069)

FN1A4P(M34)

(Q2012, Q2031, Q2046,
Q2061, Q2063)

2SA1162GR(SG)

(Q2009)

2SC2712GR(LG)

(Q2005, Q2006, Q2008,
Q2011, Q2023, Q2027,
Q2028, Q2029, Q2044,
Q2049, Q2050, Q2052,
Q2053, Q2054, Q2055,
Q2056, Q2059, Q2060,)

2SC2714

(Q2048)

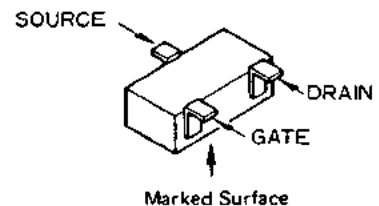

2SK302GR(TGR)

(Q2013, Q2014, Q2016,
Q2032, Q2033)

For Service Manuals Contact
MAURITRON TECHNICAL SERVICES
8 Cherry Tree Rd, Chinnor
Oxon OX9 4QY
Tel: 01844-351694 Fax: 01844-352554
Email: enquiries@mauritron.co.uk

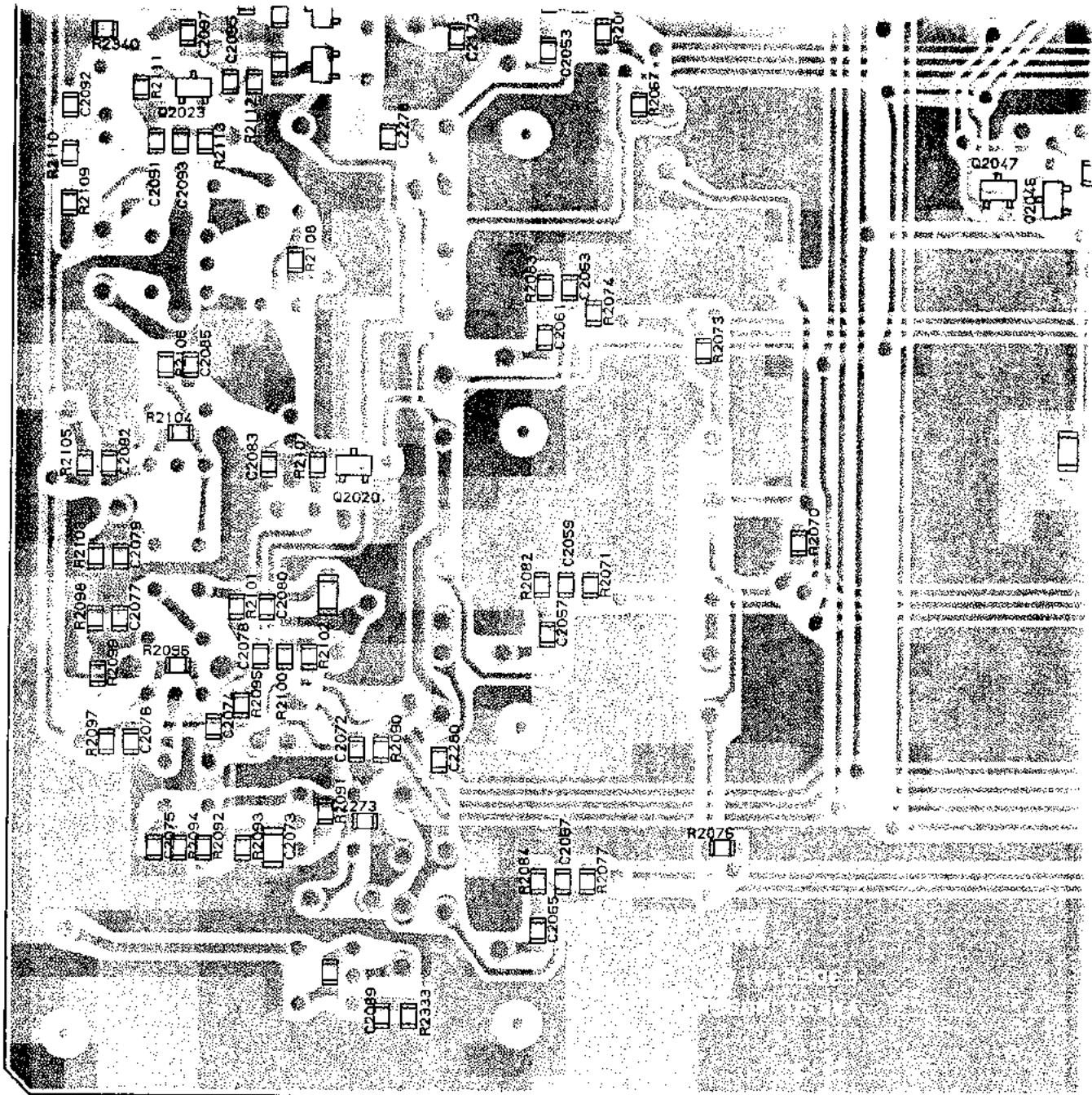

ANODE 1/CATHODE 2

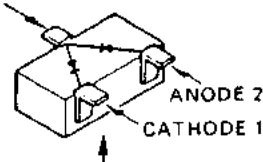

Marked Surface

1SS226 (03)

(D2104)

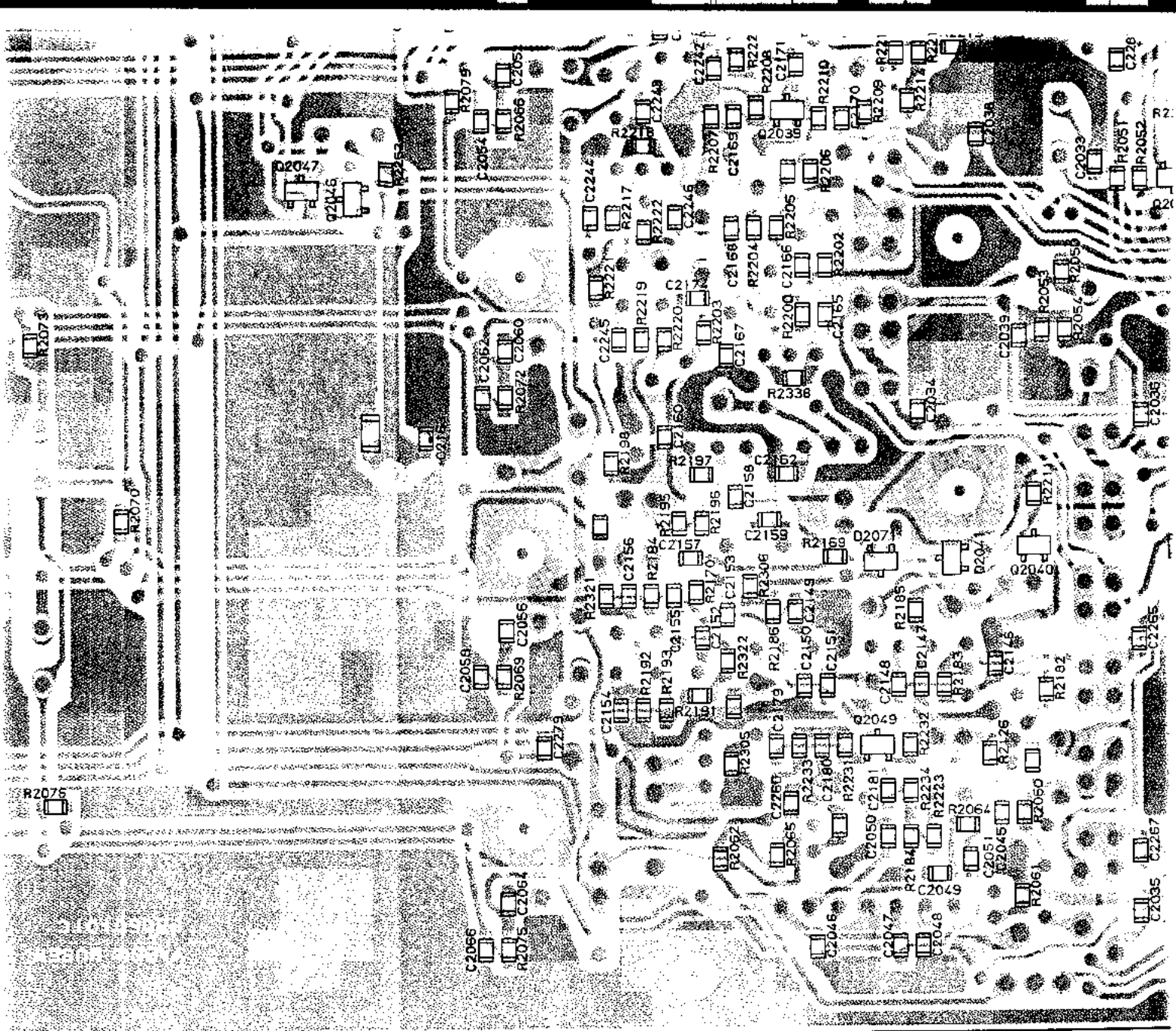

For Service Manuals Contact
MAURITRON TECHNICAL SERVICES
 8 Cherry Tree Rd, Chinnor
 Oxon OX9 4QY
 Tel: 01844-351634 Fax: 01844-352554
 Email: enquiries@mauritron.co.uk



Surface

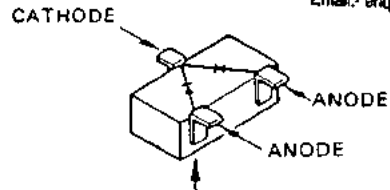

Marked Surface

1SS184(B3)
 (D2005, D2071, D2090,
 D2091, D2092, D2093)

5(C3)
 04)

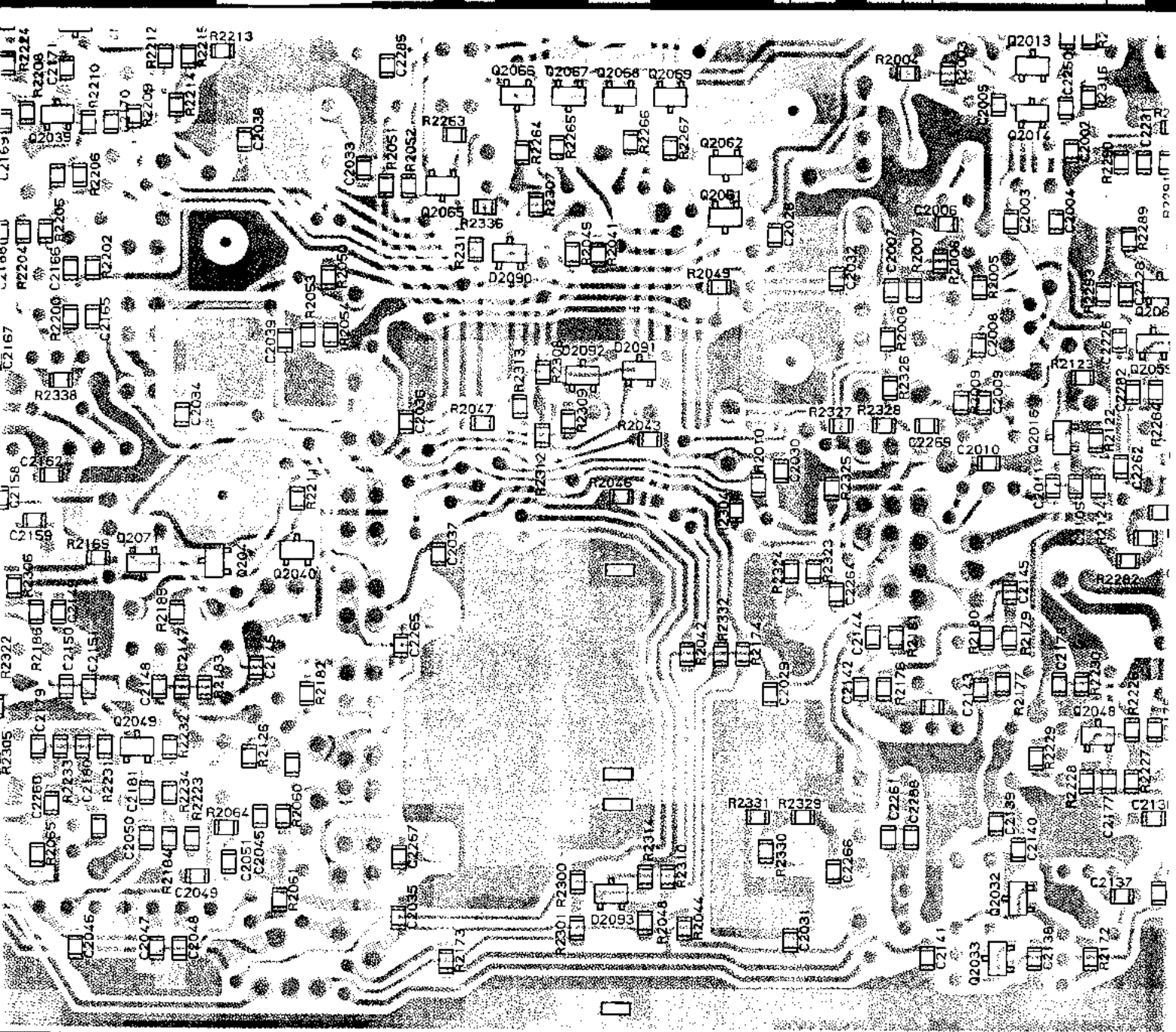

(obverse view of "chip-only" side)

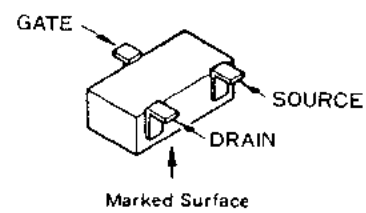
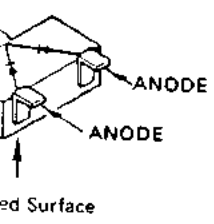

3)
 D2071, D2090,
 D2092, D2093

2SK160(K6)
 (Q2007, Q2039)

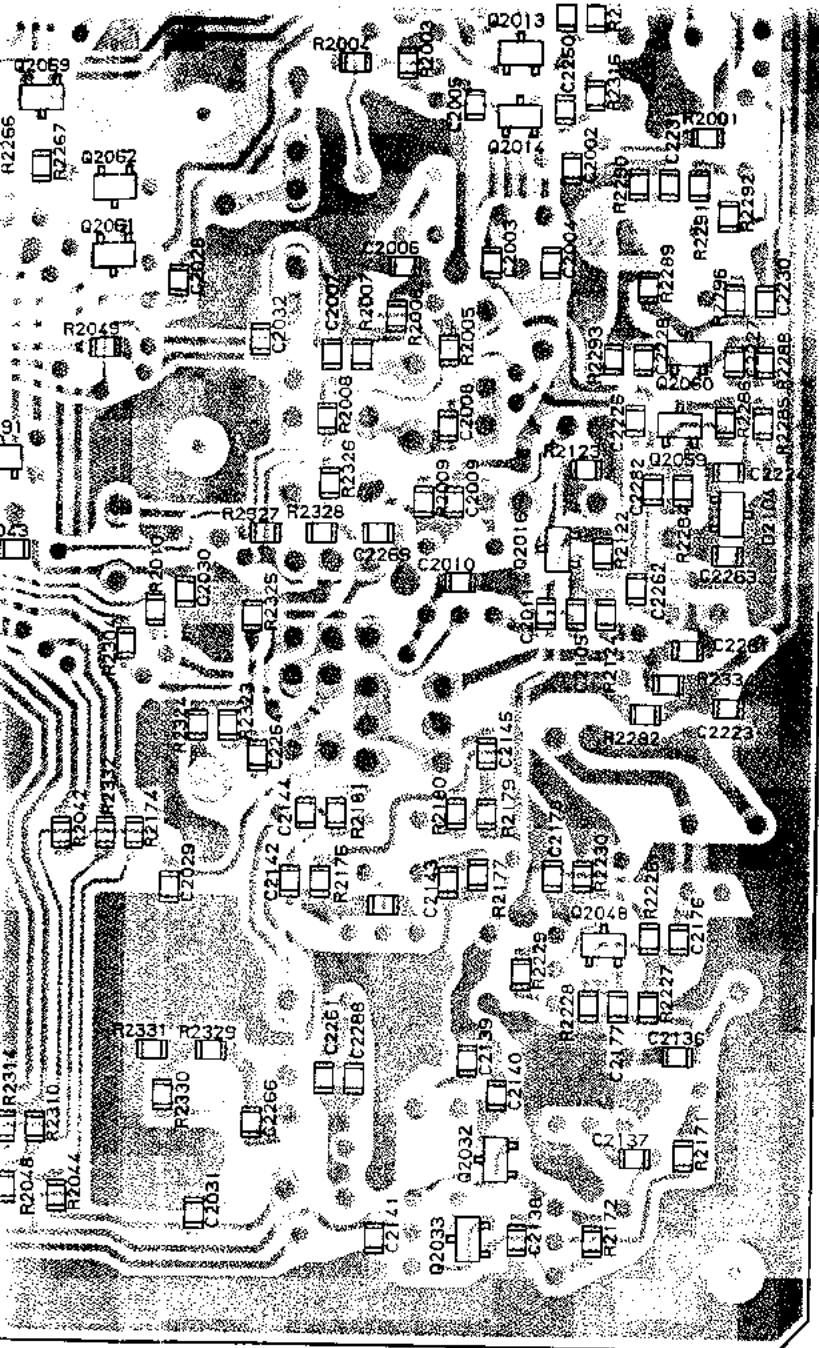

(obverse view of "chip-only" side)

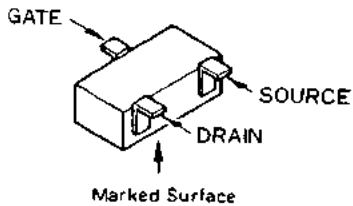

2SK160(K6)
(Q2007, Q2039)

FN1A4P(M34)
(Q2012, Q2031, Q2046,
Q2061, Q2063)

2SA1162GR(SG)
(Q2009)

2SC2712GR(LG)
(Q2005, Q2006, Q2008,
Q2011, Q2023, Q2027,
Q2028, Q2029, Q2044,
Q2049, Q2050, Q2052,
Q2053, Q2054, Q2055,
Q2056, Q2059, Q2060,

2SC2714
(Q2048)

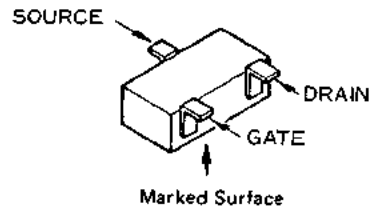

2SK302GR(TGR)
(Q2013, Q2014, Q2016,
Q2032, Q2033)

For Service Manuals Contact
MAURITRON TECHNICAL SERVICES
8 Cherry Tree Rd, Chinnor
Oxon OX9 4QY
Tel: 01844-351694 Fax: 01844-352554
Email: enquires@mauritron.co.uk

For Service Manuals Contact
MAURITRON TECHNICAL SERVICES

Cherry Tree Rd. Chinner

Oxon OX9 4QY

Tel: 01844-351694 Fax: 01844-352554

Email: enquiries@mauritron.co.uk

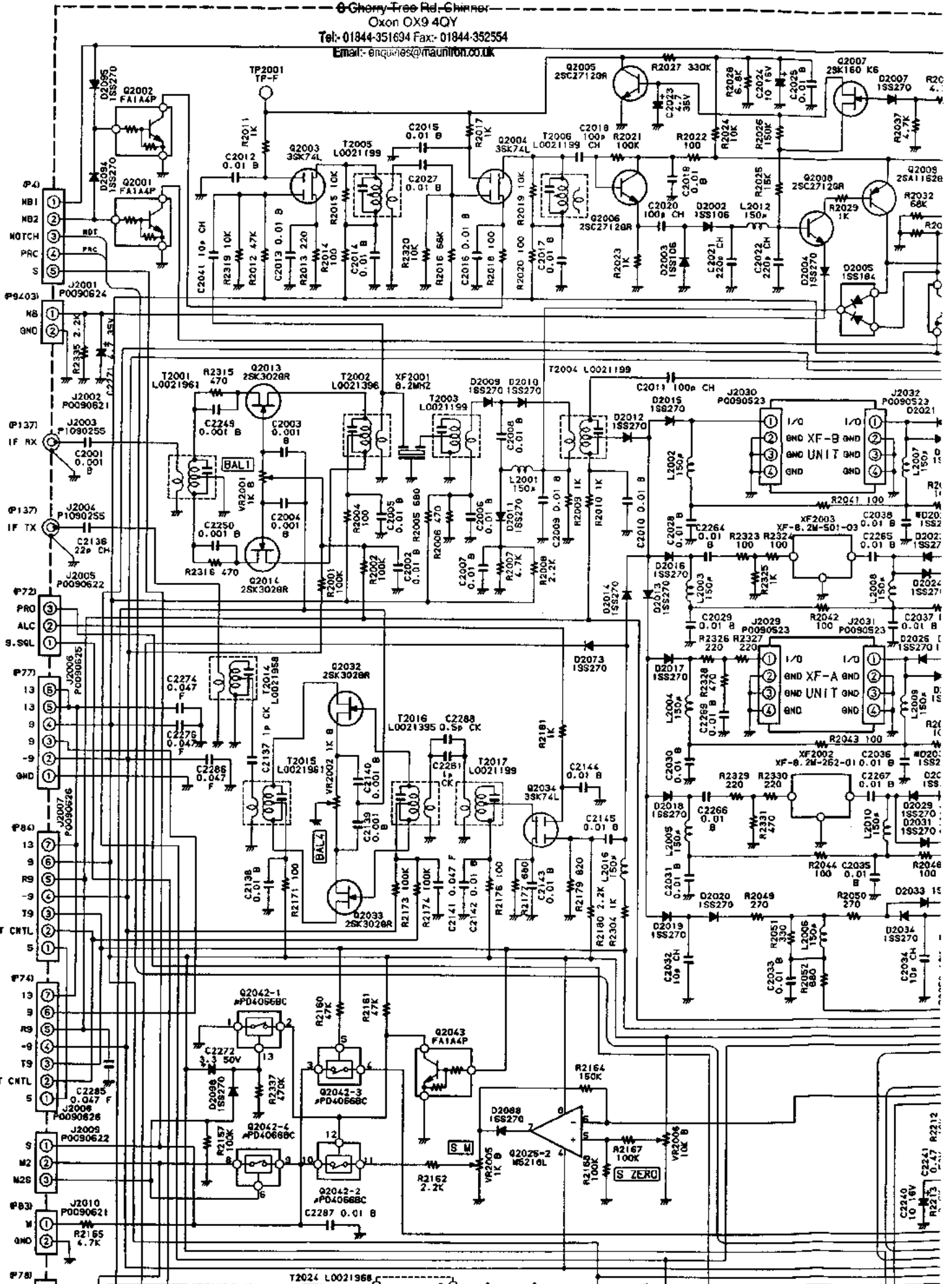

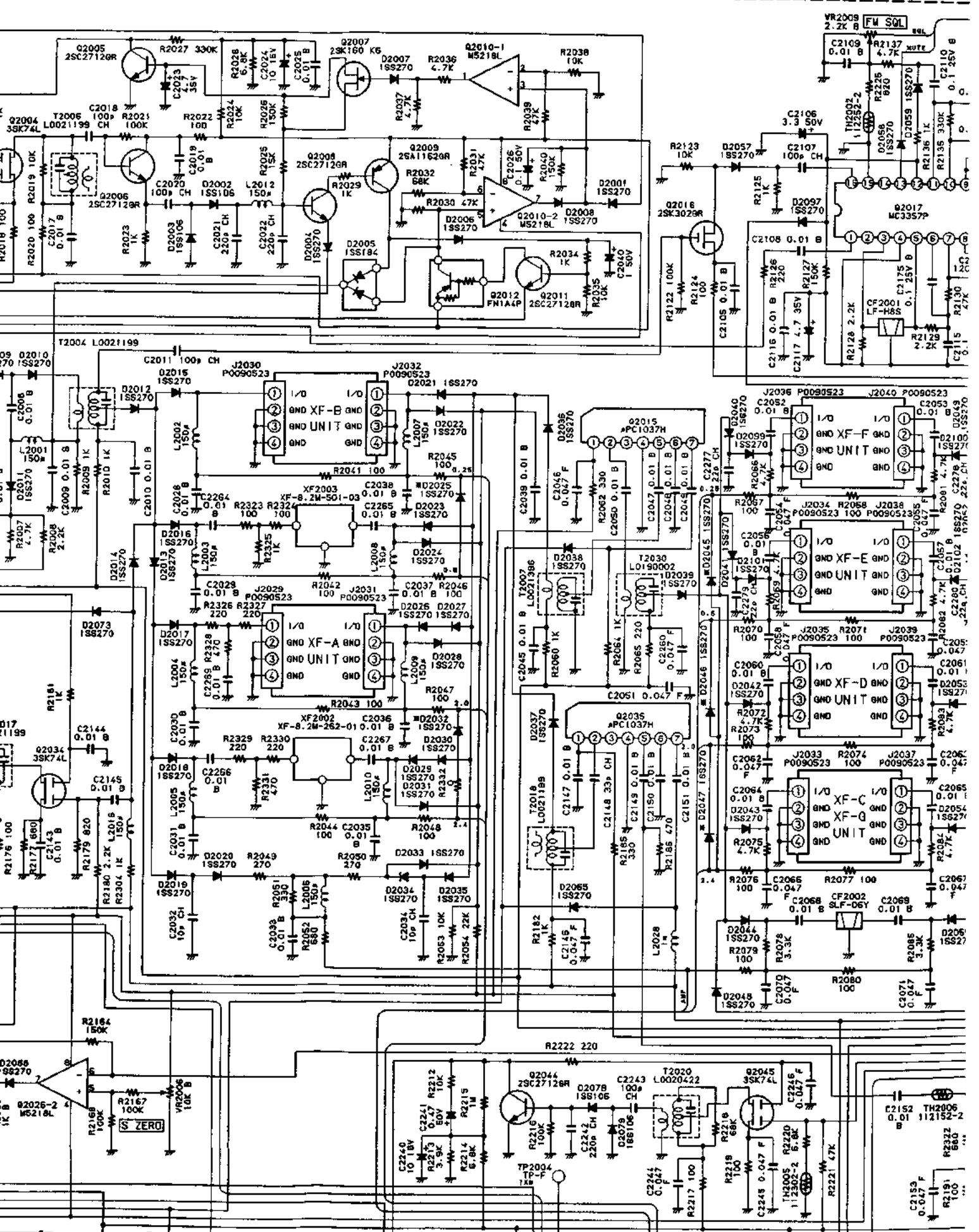

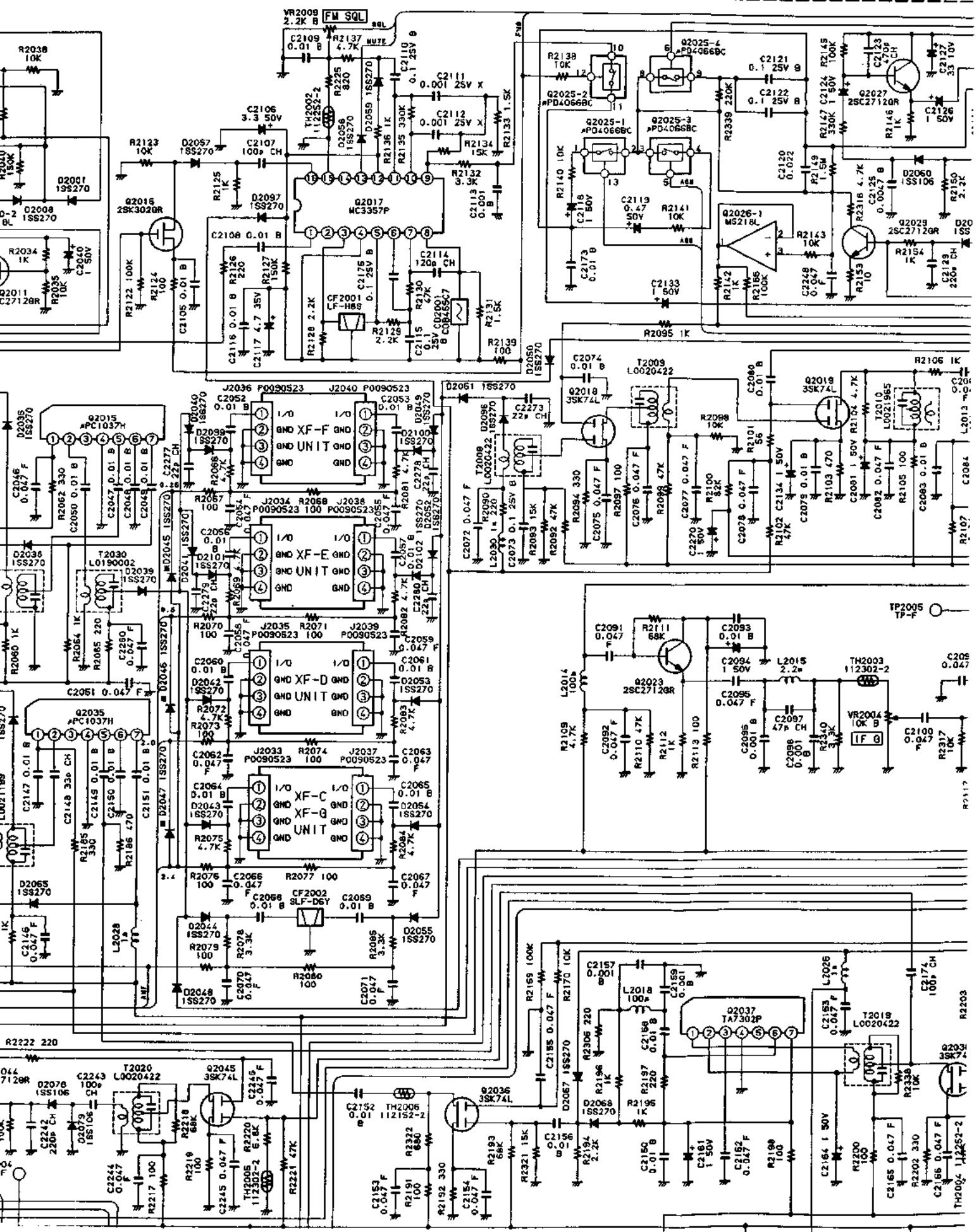

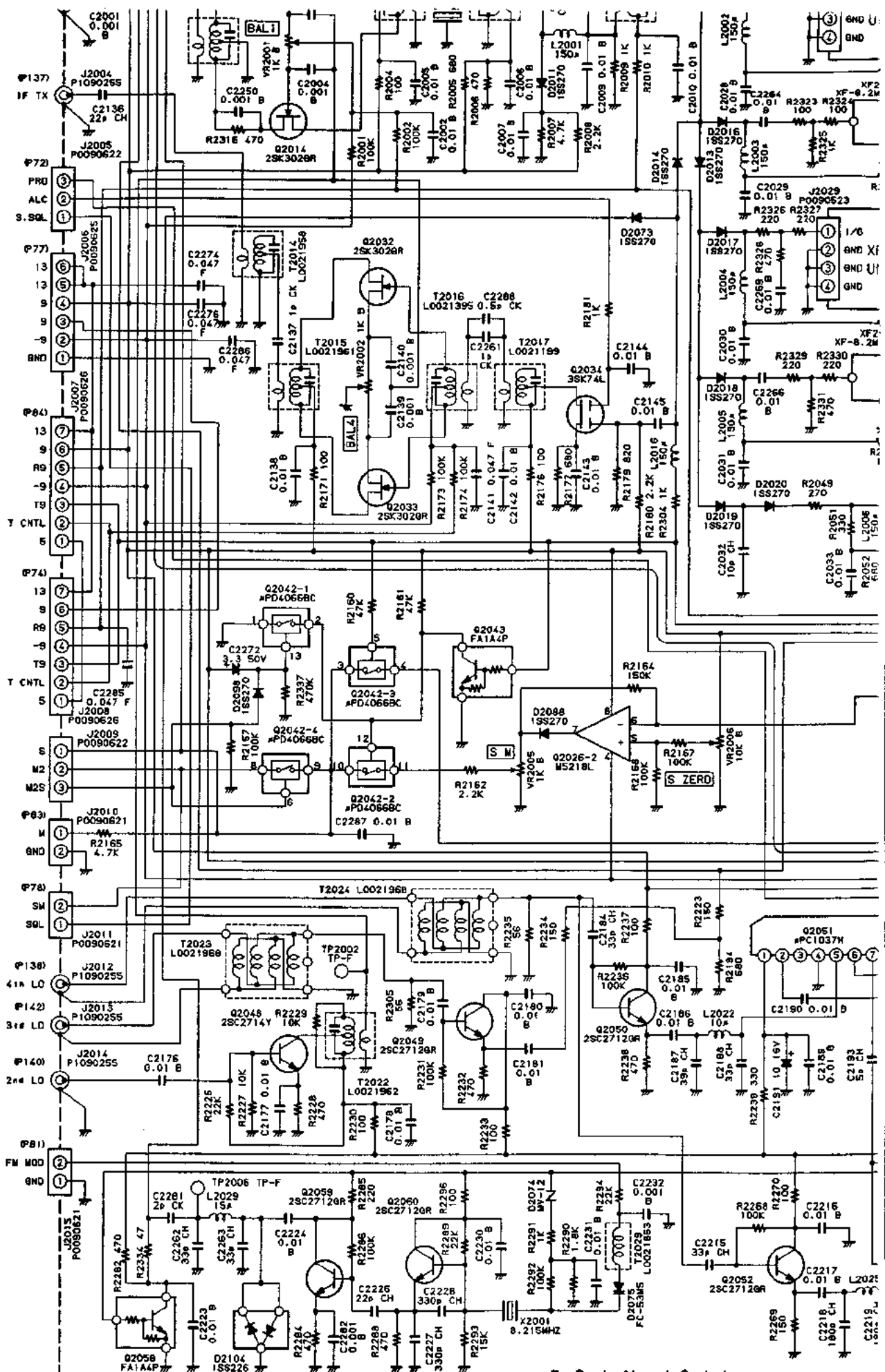

For Service Manuals Contact
MAURITRON TECHNICAL SERVICES
 8 Chery Tree Rd, Chinnor
 Oxon OX9 4QY
 Tel: 01844-351694 Fax: 01844-352554
 Email: enquiries@mauritron.co.uk

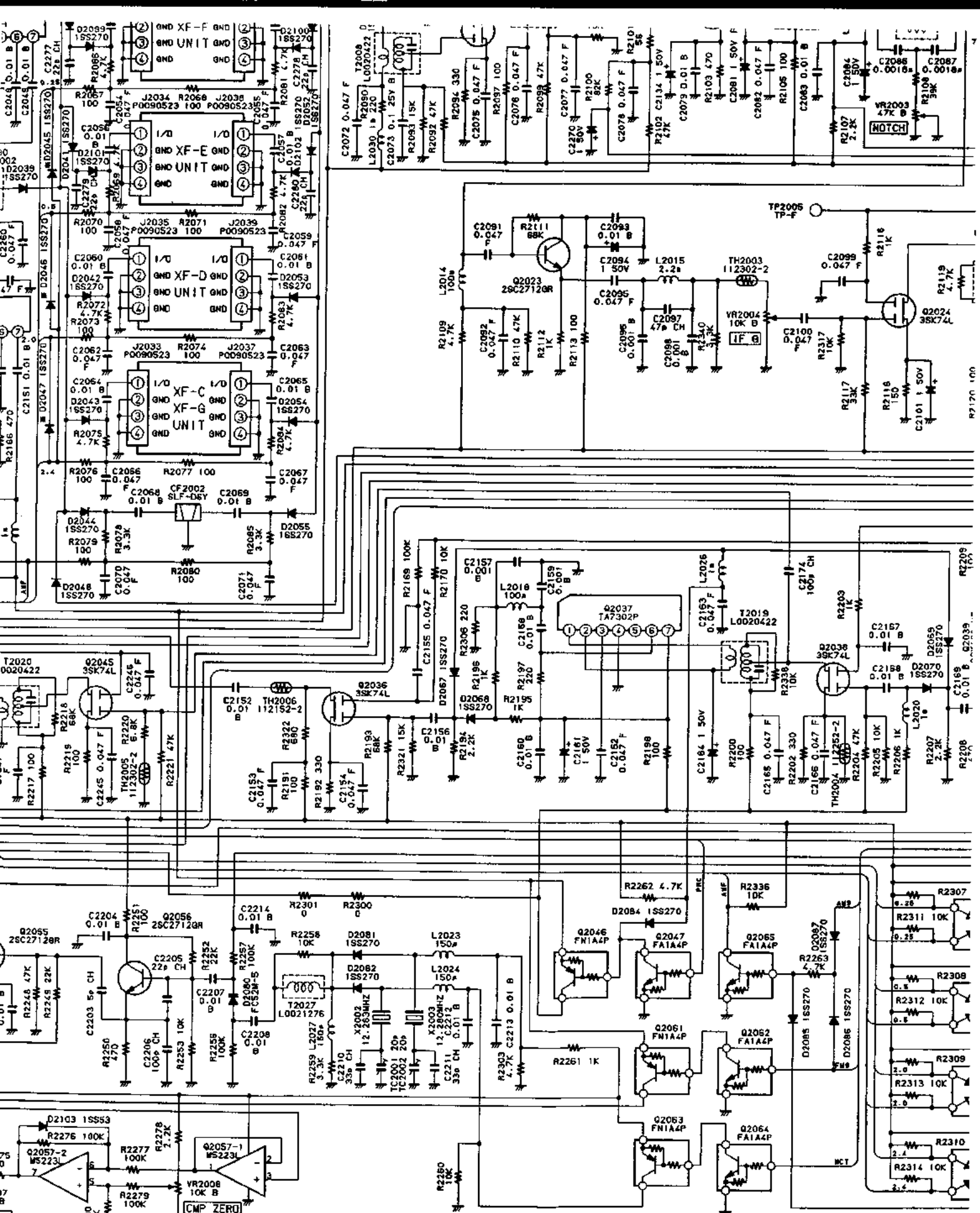

IF UNIT F3060101C

NOTE:
 RESISTOR VALUES ARE IN Ω, 1/10Ω;
 CAPACITOR VALUES ARE IN pF, 50V;
 INDUCTOR VALUES ARE IN H;
 UNLESS OTHERWISE NOTED.

	XF-A	XF-B	XF-C	XF-D	XF-E
R2000					
R2001	X				
R2002					
R2003					
R2004					
R2005					
R2006					
R2007					

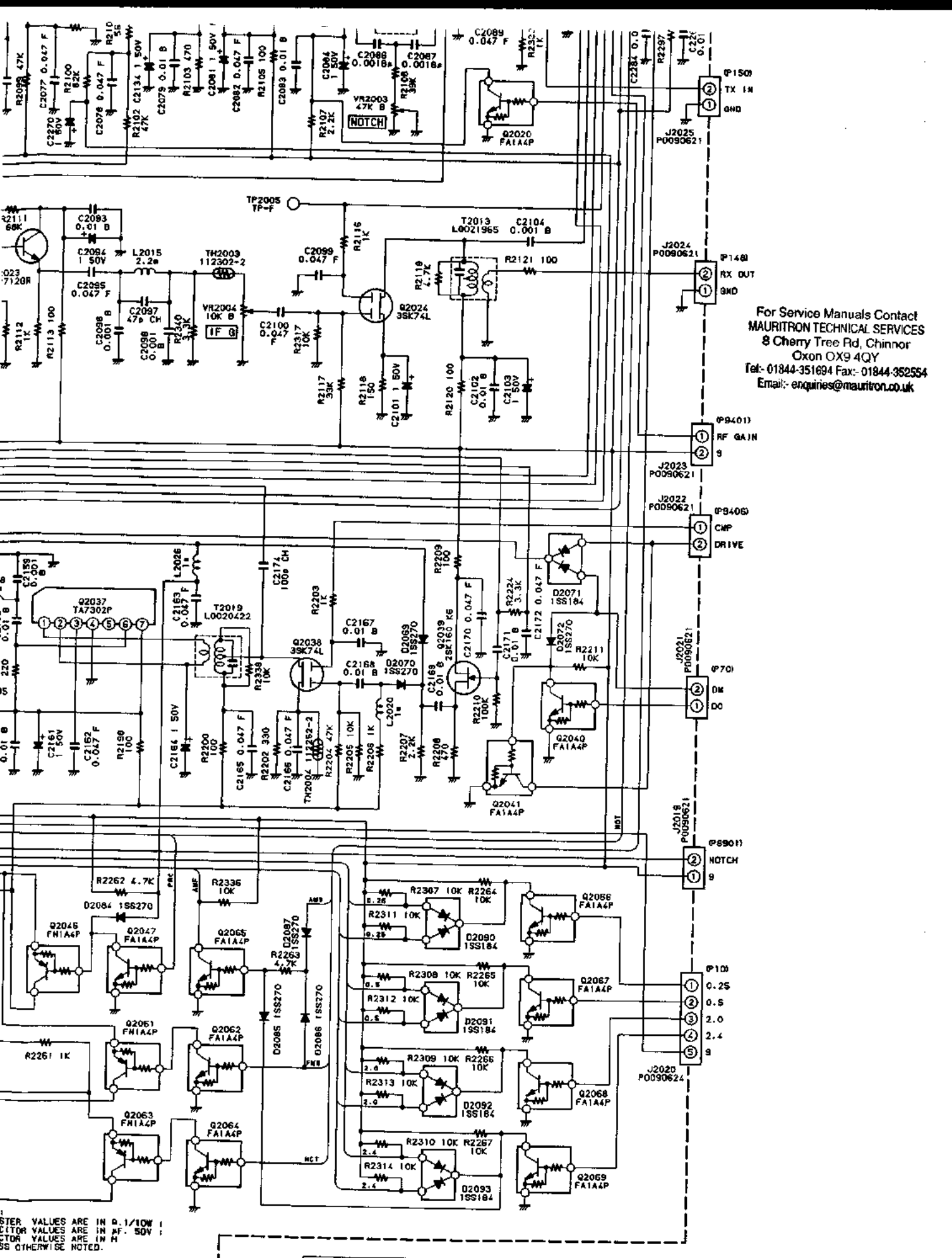

For Service Manuals Contact
MAURITRON TECHNICAL SERVICES
 8 Cherry Tree Rd, Chinnor
 Oxon OX9 4QY
 Tel: 01844-351694 Fax: 01844-352554
 Email: enquiries@mauritron.co.uk

RESISTOR VALUES ARE IN Ω , 1/10W
 CAPACITOR VALUES ARE IN nF, 50V
 UNLESS OTHERWISE NOTED.

	XF-A	XF-B	XF-C	XF-D	XF-E	XF-F
Q2020	X					
Q2021		X				
Q2022			X			
Q2023				X		
Q2024					X	
Q2025						X

IF UNIT SCHEMATIC DIAGRAM

AF Unit Parts List

ADD	CODE NO	DESCRIPTION	DEVICE			TYP	VAL
** UNIT NAME : AF-UNIT							
C 3001	K22170817	CHIP CAP.	GRM40B103M50PT	0.01uF	50V	B	
C 3002	K19149021	CERAMIC CAP.	UAT08X473K-L45AE	0.047uF	25V	X	
C 3003	K22170217	CHIP CAP.	GRM40CH180J50PT	18pF	50V	CH	
C 3004	K22170243	CHIP CAP.	GRM40CH221J50PT	220pF	50V	CH	
C 3005	K22170235	CHIP CAP.	GRM40CH101J50PT	100pF	50V	CH	
C 3006	K22170817	CHIP CAP.	GRM40B103M50PT	0.01uF	50V	B	
C 3007	K22170206	CHIP CAP.	GRM40CH050C50PT	5pF	50V	CH	
C 3008	K22170817	CHIP CAP.	GRM40B103M50PT	0.01uF	50V	B	
C 3009	K22170817	CHIP CAP.	GRM40B103M50PT	0.01uF	50V	B	
C 3010	K22170219	CHIP CAP.	GRM40CH220J50PT	22pF	50V	CH	
C 3011	K22170219	CHIP CAP.	GRM40CH220J50PT	22pF	50V	CH	
C 3012	K22170817	CHIP CAP.	GRM40B103M50PT	0.01uF	50V	B	
C 3013	K46120004	AL. ELECTRO. CAP.	16V100M4X7TR2	10uF	16V		
C 3014	K22171008	CHIP CAP.	GRM40F473Z50PT	0.047uF	50V	F	
C 3015	K22171008	CHIP CAP.	GRM40F473Z50PT	0.047uF	50V	F	
C 3016	K22170817	CHIP CAP.	GRM40B103M50PT	0.01uF	50V	B	
C 3017	K46170030	AL. ELECTRO. CAP.	50V010M4X7TR2	1uF	50V		
C 3018	K22170817	CHIP CAP.	GRM40B103M50PT	0.01uF	50V	B	
C 3019	K22170817	CHIP CAP.	GRM40B103M50PT	0.01uF	50V	B	
C 3021	K22171008	CHIP CAP.	GRM40F473Z50PT	0.047uF	50V	F	
C 3022	K46170030	AL. ELECTRO. CAP.	50V010M4X7TR2	1uF	50V		
C 3023	K22170817	CHIP CAP.	GRM40B103M50PT	0.01uF	50V	B	
C 3024	K46170030	AL. ELECTRO. CAP.	50V010M4X7TR2	1uF	50V		
C 3025	K22171008	CHIP CAP.	GRM40F473Z50PT	0.047uF	50V	F	
C 3026	K22170817	CHIP CAP.	GRM40B103M50PT	0.01uF	50V	B	
C 3027	K22170203	CHIP CAP.	GRM40CK020C50PT	2pF	50V	CK	
C 3028	K22170817	CHIP CAP.	GRM40B103M50PT	0.01uF	50V	B	
C 3029	K22171008	CHIP CAP.	GRM40F473Z50PT	0.047uF	50V	F	
C 3030	K22170239	CHIP CAP.	GRM40CH151J50PT	150pF	50V	CH	
C 3031	K22171008	CHIP CAP.	GRM40F473Z50PT	0.047uF	50V	F	
C 3032	K22170817	CHIP CAP.	GRM40B103M50PT	0.01uF	50V	B	
C 3033	K22170251	CHIP CAP.	GRM40CH471J50PT	470pF	50V	CH	
C 3034	K22170251	CHIP CAP.	GRM40CH471J50PT	470pF	50V	CH	
C 3035	K22170817	CHIP CAP.	GRM40B103M50PT	0.01uF	50V	B	
C 3036	K22141809	CHIP CAP.	GRM42-6B104M25PT	0.1uF	25V	B	
C 3037	K22170817	CHIP CAP.	GRM40B103M50PT	0.01uF	50V	B	
C 3038	K22170817	CHIP CAP.	GRM40B103M50PT	0.01uF	50V	B	
C 3039	K22170817	CHIP CAP.	GRM40B103M50PT	0.01uF	50V	B	
C 3040	K22170817	CHIP CAP.	GRM40B103M50PT	0.01uF	50V	B	
C 3041	K22170219	CHIP CAP.	GRM40CH220J50PT	22pF	50V	CH	
C 3042	K22170817	CHIP CAP.	GRM40B103M50PT	0.01uF	50V	B	
C 3043	K22170817	CHIP CAP.	GRM40B103M50PT	0.01uF	50V	B	
C 3044	K22170219	CHIP CAP.	GRM40CH220J50PT	22pF	50V	CH	
C 3045	K22170219	CHIP CAP.	GRM40CH220J50PT	22pF	50V	CH	
C 3046	K22170817	CHIP CAP.	GRM40B103M50PT	0.01uF	50V	B	
C 3047	K22170817	CHIP CAP.	GRM40B103M50PT	0.01uF	50V	B	
C 3048	K22141809	CHIP CAP.	GRM42-6B104M25PT	0.1uF	25V	B	
C 3049	K46170030	AL. ELECTRO. CAP.	50V010M4X7TR2	1uF	50V		
C 3050	K22170817	CHIP CAP.	GRM40B103M50PT	0.01uF	50V	B	
C 3051	K22171008	CHIP CAP.	GRM40F473Z50PT	0.047uF	50V	F	
C 3052	K22171008	CHIP CAP.	GRM40F473Z50PT	0.047uF	50V	F	
C 3053	K22170817	CHIP CAP.	GRM40B103M50PT	0.01uF	50V	B	
C 3054	K46120004	AL. ELECTRO. CAP.	16V100M4X7TR2	10uF	16V		
C 3057	K22171008	CHIP CAP.	GRM40F473Z50PT	0.047uF	50V	F	
C 3058	K22170817	CHIP CAP.	GRM40B103M50PT	0.01uF	50V	B	
C 3059	K46170030	AL. ELECTRO. CAP.	50V010M4X7TR2	1uF	50V		
C 3060	K22170817	CHIP CAP.	GRM40B103M50PT	0.01uF	50V	B	
C 3061	K46120004	AL. ELECTRO. CAP.	16V100M4X7TR2	10uF	16V		
C 3062	K46160004	AL. ELECTRO. CAP.	35V4R7M4X7TR2	4.7uF	35V		
C 3063	K22170815	CHIP CAP.	GRM40B682M50PT	0.0068uF	50V	B	
C 3064	K22170811	CHIP CAP.	GRM40B332M50PT	0.0033uF	50V	B	
C 3065	K46160004	AL. ELECTRO. CAP.	35V4R7M4X7TR2	4.7uF	35V		
C 3066	K22170813	CHIP CAP.	GRM40B472M50PT	0.0047uF	50V	B	
C 3067	K22170809	CHIP CAP.	GRM40B222M50PT	0.0022uF	50V	B	
C 3068	K46160004	AL. ELECTRO. CAP.	35V4R7M4X7TR2	4.7uF	35V		
C 3069	K22170819	CHIP CAP.	GRM40B153M50PT	0.015	50V	B	
C 3070	K22170815	CHIP CAP.	GRM40B682M50PT	0.0068uF	50V	B	
C 3071	K46160004	AL. ELECTRO. CAP.	35V4R7M4X7TR2	4.7uF	35V		
C 3072	K46160004	AL. ELECTRO. CAP.	35V4R7M4X7TR2	4.7uF	35V		
C 3073	K22170821	CHIP CAP.	GRM40B223M50PT	0.022uF	50V	B	
C 3074	K22170821	CHIP CAP.	GRM40B223M50PT	0.022uF	50V	B	
C 3075	K46120004	AL. ELECTRO. CAP.	16V100M4X7TR2	10uF	16V		
C 3076	K46160004	AL. ELECTRO. CAP.	35V4R7M4X7TR2	4.7uF	35V		
C 3077	K46170030	AL. ELECTRO. CAP.	50V010M4X7TR2	1uF	50V		
C 3078	K22171008	CHIP CAP.	GRM40F473Z50PT	0.047uF	50V	F	
C 3079	K46120004	AL. ELECTRO. CAP.	16V100M4X7TR2	10uF	16V		
C 3080	K22170809	CHIP CAP.	GRM40B222M50PT	0.0022uF	50V	B	
C 3081	K46170030	AL. ELECTRO. CAP.	50V010M4X7TR2	1uF	50V		
C 3082	K46120005	AL. ELECTRO. CAP.	16V220M5X7TR2	22uF	16V		
C 3083	K46170030	AL. ELECTRO. CAP.	50V010M4X7TR2	1uF	50V		
C 3084	K46170030	AL. ELECTRO. CAP.	50V010M4X7TR2	1uF	50V		
C 3085	K22170817	CHIP CAP.	GRM40B103M50PT	0.01uF	50V	B	

AF Unit Parts List

ADD	CODE NO	DESCRIPTION	DEVICE	TYP	VAL
C 3086	K46120004	AL. ELECTRO. CAP.	16V100M4X7TR2	10uF	16V
C 3087	K46170030	AL. ELECTRO. CAP.	50V010M4X7TR2	1uF	50V
C 3088	K46120005	AL. ELECTRO. CAP.	16V220M5X7TR2	22uF	16V
C 3089	K46170030	AL. ELECTRO. CAP.	50V010M4X7TR2	1uF	50V
C 3090	K46170030	AL. ELECTRO. CAP.	50V010M4X7TR2	1uF	50V
C 3091	K22170817	CHIP CAP.	GRM40B103M50PT	0.01uF	50V B
C 3092	K46120005	AL. ELECTRO. CAP.	16V220M5X7TR2	22uF	16V
C 3093	K22170817	CHIP CAP.	GRM40B103M50PT	0.01uF	50V B
C 3094	K46120004	AL. ELECTRO. CAP.	16V100M4X7TR2	10uF	16V
C 3095	K22170817	CHIP CAP.	GRM40B103M50PT	0.01uF	50V B
C 3096	K46120005	AL. ELECTRO. CAP.	16V220M5X7TR2	22uF	16V
C 3097	K46120005	AL. ELECTRO. CAP.	16V220M5X7TR2	22uF	16V
C 3098	K46170030	AL. ELECTRO. CAP.	50V010M4X7TR2	1uF	50V
C 3099	K22170817	CHIP CAP.	GRM40B103M50PT	0.01uF	50V B
C 3100	K46170030	AL. ELECTRO. CAP.	50V010M4X7TR2	1uF	50V
C 3101	K22170817	CHIP CAP.	GRM40B103M50PT	0.01uF	50V B
C 3102	K46120004	AL. ELECTRO. CAP.	16V100M4X7TR2	10uF	16V
C 3103	K22170821	CHIP CAP.	GRM40B223M50PT	0.022uF	50V B
C 3104	K22170817	CHIP CAP.	GRM40B103M50PT	0.01uF	50V B
C 3105	K46120007	AL. ELECTRO. CAP.	16V101M6X7TR2	100uF	16V
C 3106	K40089025	AL. ELECTRO. CAP.	RE2-6V471M	470uF	6.3V
C 3107	K40129049	AL. ELECTRO. CAP.	RE2-16V471M	470uF	16V
C 3108	K46120007	AL. ELECTRO. CAP.	16V101M6X7TR2	100uF	16V
C 3109	K46120006	AL. ELECTRO. CAP.	16V470M6X7TR2	47uF	16V
C 3110	K50177104	FILM CAP. 50F2U104M	50F2U104M	0.1	50V
C 3111	K22170817	CHIP CAP.	GRM40B103M50PT	0.01uF	50V B
C 3112	K22170817	CHIP CAP.	GRM40B103M50PT	0.01uF	50V B
C 3113	K22171008	CHIP CAP.	GRM40F473Z50PT	0.047uF	50V F
C 3114	K22170817	CHIP CAP.	GRM40B103M50PT	0.01uF	50V B
C 3115	K22170817	CHIP CAP.	GRM40B103M50PT	0.01uF	50V B
C 3116	K22170817	CHIP CAP.	GRM40B103M50PT	0.01uF	50V B
C 3117	K46120004	AL. ELECTRO. CAP.	16V100M4X7TR2	10uF	16V
C 3118	K22170219	CHIP CAP.	GRM40CH220J50PT	22pF	50V CH
C 3119	K22170817	CHIP CAP.	GRM40B103M50PT	0.01uF	50V B
C 3120	K22170817	CHIP CAP.	GRM40B103M50PT	0.01uF	50V B
C 3121	K22170817	CHIP CAP.	GRM40B103M50PT	0.01uF	50V B
C 3122	K46120004	AL. ELECTRO. CAP.	16V100M4X7TR2	10uF	16V
C 3123	K46160004	AL. ELECTRO. CAP.	35V4R7M4X7TR2	4.7uF	35V
C 3124	K46160004	AL. ELECTRO. CAP.	35V4R7M4X7TR2	4.7uF	35V
C 3125	K46160004	AL. ELECTRO. CAP.	35V4R7M4X7TR2	4.7uF	35V
C 3126	K22170243	CHIP CAP.	GRM40CH221J50PT	220pF	50V CH
C 3127	K46120004	AL. ELECTRO. CAP.	16V100M4X7TR2	10uF	16V
C 3128	K46160004	AL. ELECTRO. CAP.	35V4R7M4X7TR2	4.7uF	35V
C 3129	K22170817	CHIP CAP.	GRM40B103M50PT	0.01uF	50V B
C 3130	K46120005	AL. ELECTRO. CAP.	16V220M5X7TR2	22uF	16V
C 3131	K46160004	AL. ELECTRO. CAP.	35V4R7M4X7TR2	4.7uF	35V
C 3132	K46100005	AL. ELECTRO. CAP.	10V221M6X11TR5	220uF	10V
C 3133	K46120004	AL. ELECTRO. CAP.	16V100M4X7TR2	10uF	16V
C 3134	K22170805	CHIP CAP.	GRM40B102M50PT	0.001uF	50V B
C 3135	K46170030	AL. ELECTRO. CAP.	50V010M4X7TR2	1uF	50V
C 3136	K22170805	CHIP CAP.	GRM40B102M50PT	0.001uF	50V B
C 3137	K46120004	AL. ELECTRO. CAP.	16V100M4X7TR2	10uF	16V
C 3138	K46170030	AL. ELECTRO. CAP.	50V010M4X7TR2	1uF	50V
C 3139	K22171008	CHIP CAP.	GRM40F473Z50PT	0.047uF	50V F
C 3140	K46120004	AL. ELECTRO. CAP.	16V100M4X7TR2	10uF	16V
C 3141	K46170030	AL. ELECTRO. CAP.	50V010M4X7TR2	1uF	50V
C 3142	K46170029	AL. ELECTRO. CAP.	50VR47M4X7TR2	0.47uF	50V
C 3143	K46170030	AL. ELECTRO. CAP.	50V010M4X7TR2	1uF	50V
C 3144	K46120004	AL. ELECTRO. CAP.	16V100M4X7TR2	10uF	16V
C 3145	K52170007	FILM CAP. ECQ-V1H474JZW	ECQ-V1H474JZW	0.47	50V
C 3146	K22171008	CHIP CAP.	GRM40F473Z50PT	0.047uF	50V F
C 3147	K46120004	AL. ELECTRO. CAP.	16V100M4X7TR2	10uF	16V
C 3148	K46170030	AL. ELECTRO. CAP.	50V010M4X7TR2	1uF	50V
C 3149	K46170030	AL. ELECTRO. CAP.	50V010M4X7TR2	1uF	50V
C 3150	K46120004	AL. ELECTRO. CAP.	16V100M4X7TR2	10uF	16V
C 3151	K46170030	AL. ELECTRO. CAP.	50V010M4X7TR2	1uF	50V
C 3152	K46170030	AL. ELECTRO. CAP.	50V010M4X7TR2	1uF	50V
C 3153	K46120004	AL. ELECTRO. CAP.	16V100M4X7TR2	10uF	16V
C 3154	K46170030	AL. ELECTRO. CAP.	50V010M4X7TR2	1uF	50V
C 3155	K46170030	AL. ELECTRO. CAP.	50V010M4X7TR2	1uF	50V
C 3156	K46120004	AL. ELECTRO. CAP.	16V100M4X7TR2	10uF	16V
C 3157	K46170030	AL. ELECTRO. CAP.	50V010M4X7TR2	1uF	50V
C 3158	K46170030	AL. ELECTRO. CAP.	50V010M4X7TR2	1uF	50V
C 3159	K46120004	AL. ELECTRO. CAP.	16V100M4X7TR2	10uF	16V
C 3160	K46170030	AL. ELECTRO. CAP.	50V010M4X7TR2	1uF	50V
C 3161	K46170030	AL. ELECTRO. CAP.	50V010M4X7TR2	1uF	50V
C 3162	K46120004	AL. ELECTRO. CAP.	16V100M4X7TR2	10uF	16V
C 3163	K46170030	AL. ELECTRO. CAP.	50V010M4X7TR2	1uF	50V
C 3167	K46120005	AL. ELECTRO. CAP.	16V220M5X7TR2	22uF	16V
C 3168	K22170817	CHIP CAP.	GRM40B103M50PT	0.01uF	50V B
C 3169	K46120004	AL. ELECTRO. CAP.	16V100M4X7TR2	10uF	16V
C 3170	K22170222	CHIP CAP.	GRM40CH300J50PT	30p	50V CH
C 3171	K22170222	CHIP CAP.	GRM40CH300J50PT	30p	50V CH

AF Unit Parts List

ADD	CODE NO	DESCRIPTION	DEVICE	TYP	VAL
C	3172	K46120004	AL.ELECTRO.CAP.	16V100M4X7TR2	10uF 16V
C	3173	K22170805	CHIP CAP.	GRM40B102M50PT	0.001uF 50V B
C	3174	K22170805	CHIP CAP.	GRM40B102M50PT	0.001uF 50V B
C	3175	K22170817	CHIP CAP.	GRM40B103M50PT	0.01uF 50V B
C	3176	K22171008	CHIP CAP.	GRM40F473Z50PT	0.047uF 50V F
C	3177	K22171008	CHIP CAP.	GRM40F473Z50PT	0.047uF 50V F
C	3178	K46120004	AL.ELECTRO.CAP.	16V100M4X7TR2	10uF 16V
C	3181	K22170204	CHIP CAP.	GRM40CJ030C50PT	3pF 50V CJ
C	3185	K22170817	CHIP CAP.	GRM40B103M50PT	0.01uF 50V B
C	3186	K22170225	CHIP CAP.	GRM40CH390J50PT	39pF 50V CH
C	3187	K22170225	CHIP CAP.	GRM40CH390J50PT	39pF 50V CH
C	3190	K22170817	CHIP CAP.	GRM40B103M50PT	0.01uF 50V B
C	3191	K46120004	AL.ELECTRO.CAP.	16V100M4X7TR2	10uF 16V
C	3193	K22170815	CHIP CAP.	GRM40B682M50PT	0.0068uF 50V B
C	3194	K22170811	CHIP CAP.	GRM40B332M50PT	0.0033uF 50V B
C	3198	K22170821	CHIP CAP.	GRM40B223M50PT	0.022uF 50V B
C	3199	K22170817	CHIP CAP.	GRM40B103M50PT	0.01uF 50V B
C	3201	K22170817	CHIP CAP.	GRM40B103M50PT	0.01uF 50V B
C	3202	K46170030	AL.ELECTRO.CAP.	50V010M4X7TR2	1uF 50V
C	3203	K46170030	AL.ELECTRO.CAP.	50V010M4X7TR2	1uF 50V
C	3204	K46120004	AL.ELECTRO.CAP.	16V100M4X7TR2	10uF 16V
C	3205	K46170029	AL.ELECTRO.CAP.	50VR47M4X7TR2	0.47uF 50V
C	3207	K46120004	AL.ELECTRO.CAP.	16V100M4X7TR2	10uF 16V
C	3208	K22170805	CHIP CAP.	GRM40B102M50PT	0.001uF 50V B
C	3209	K22170235	CHIP CAP.	GRM40CH101J50PT	100pF 50V CH
C	3210	K22170235	CHIP CAP.	GRM40CH101J50PT	100pF 50V CH
C	3211	K46170031	AL.ELECTRO.CAP.	50V2R2M4X7TR2	2.2uF 50V
C	3212	K22170805	CHIP CAP.	GRM40B102M50PT	0.001uF 50V B
C	3213	K22170817	CHIP CAP.	GRM40B103M50PT	0.01uF 50V B
C	3214	K22170817	CHIP CAP.	GRM40B103M50PT	0.01uF 50V B
C	3221	K22171008	CHIP CAP.	GRM40F473Z50PT	0.047uF 50V F
C	3223	K46120004	AL.ELECTRO.CAP.	16V100M4X7TR2	10uF 16V
C	3224	K22170817	CHIP CAP.	GRM40B103M50PT	0.01uF 50V B
C	3225	K22170817	CHIP CAP.	GRM40B103M50PT	0.01uF 50V B
C	3226	K46120007	AL.ELECTRO.CAP.	16V101M6X7TR2	100uF 16V
C	3227	K22171008	CHIP CAP.	GRM40F473Z50PT	0.047uF 50V F
C	3228	K22171008	CHIP CAP.	GRM40F473Z50PT	0.047uF 50V F
C	3229	K46120004	AL.ELECTRO.CAP.	16V100M4X7TR2	10uF 16V
C	3230	K46170030	AL.ELECTRO.CAP.	50V010M4X7TR2	1uF 50V
C	3231	K46170030	AL.ELECTRO.CAP.	50V010M4X7TR2	1uF 50V
C	3232	K22170811	CHIP CAP.	GRM40B332M50PT	0.0033uF 50V B
C	3233	K46170030	AL.ELECTRO.CAP.	50V010M4X7TR2	1uF 50V
C	3234	K46170030	AL.ELECTRO.CAP.	50V010M4X7TR2	1uF 50V
C	3235	K46120004	AL.ELECTRO.CAP.	16V100M4X7TR2	10uF 16V
C	3236	K22171008	CHIP CAP.	GRM40F473Z50PT	0.047uF 50V F
C	3237	K22170813	CHIP CAP.	GRM40B472M50PT	0.0047uF 50V B
C	3238	K22170813	CHIP CAP.	GRM40B472M50PT	0.0047uF 50V B
C	3239	K22170813	CHIP CAP.	GRM40B472M50PT	0.0047uF 50V B
C	3240	K46120004	AL.ELECTRO.CAP.	16V100M4X7TR2	10uF 16V
C	3241	K46170030	AL.ELECTRO.CAP.	50V010M4X7TR2	1uF 50V
C	3242	K46170029	AL.ELECTRO.CAP.	50VR47M4X7TR2	0.47uF 50V
C	3243	K46170030	AL.ELECTRO.CAP.	50V010M4X7TR2	1uF 50V
C	3244	K46140006	AL.ELECTRO.CAP.	25V221M8X11TR5	220uF 25V
C	3245	K46140006	AL.ELECTRO.CAP.	25V221M8X11TR5	220uF 25V
C	3246	K46170027	AL.ELECTRO.CAP.	50VR22M4X7TR2	0.22uF 50V
C	3247	K22170817	CHIP CAP.	GRM40B103M50PT	0.01uF 50V B
C	3248	K22170817	CHIP CAP.	GRM40B103M50PT	0.01uF 50V B
C	3249	K22170805	CHIP CAP.	GRM40B102M50PT	0.001uF 50V B
C	3250	K46170028	AL.ELECTRO.CAP.	50VR33M4X7TR2	0.33uF 50V
C	3251	K46170032	AL.ELECTRO.CAP.	50V3R3M4X7TR2	3.3uF 50V
C	3252	K22170817	CHIP CAP.	GRM40B103M50PT	0.01uF 50V B
C	3253	K46170032	AL.ELECTRO.CAP.	50V3R3M4X7TR2	3.3uF 50V
C	3254	K22170817	CHIP CAP.	GRM40B103M50PT	0.01uF 50V B
C	3255	K22170817	CHIP CAP.	GRM40B103M50PT	0.01uF 50V B
C	3256	K22170817	CHIP CAP.	GRM40B103M50PT	0.01uF 50V B
C	3257	K22170817	CHIP CAP.	GRM40B103M50PT	0.01uF 50V B
C	3258	K22170817	CHIP CAP.	GRM40B103M50PT	0.01uF 50V B
C	3259	K22141005	CHIP CAP.	GRM40F104Z25PT	0.1uF 25V F
C	3260	K22141005	CHIP CAP.	GRM40F104Z25PT	0.1uF 25V F
C	3261	K22170817	CHIP CAP.	GRM40B103M50PT	0.01uF 50V B
C	3262	K22171008	CHIP CAP.	GRM40F473Z50PT	0.047uF 50V F
C	3263	K22171008	CHIP CAP.	GRM40F473Z50PT	0.047uF 50V F
C	3264	K22171008	CHIP CAP.	GRM40F473Z50PT	0.047uF 50V F
C	3265	K22170817	CHIP CAP.	GRM40B103M50PT	0.01uF 50V B
C	3266	K22171008	CHIP CAP.	GRM40F473Z50PT	0.047uF 50V F
C	3267	K22171008	CHIP CAP.	GRM40F473Z50PT	0.047uF 50V F
C	3268	K46170030	AL.ELECTRO.CAP.	50V010M4X7TR2	1uF 50V
CO	3001	H7900170	CERAMIC OSC	CSA4.00MG5	
D	3001	G2090073	DIODE	FC-52M	
D	3002	G2060004	DIODE	1SS270TJ	
D	3003	G2090188	DIODE	HZ5C1	
D	3004	G2060004	DIODE	1SS270TJ	
D	3005	G2090247	DIODE	ND487C1-3R	

For Service Manuals Contact
MAURITRON TECHNICAL SERVICES
 8 Cherry Tree Rd, Chinnor
 Oxon OX9 4QY
 Tel: 01844-351694 Fax: 01844-352554
 Email: enquiries@maurtron.co.uk

AF Unit Parts List

ADD	CODE NO	DESCRIPTION	DEVICE	TYP VAL
D	3006	G2060004	DIODE	1SS270TJ
D	3007	G2060004	DIODE	1SS270TJ
D	3008	G2060004	DIODE	1SS270TJ
D	3009	G2060004	DIODE	1SS270TJ
D	3010	G2060004	DIODE	1SS270TJ
D	3011	G2060004	DIODE	1SS270TJ
D	3012	G2060004	DIODE	1SS270TJ
D	3013	G2060004	DIODE	1SS270TJ
D	3014	G2060004	DIODE	1SS270TJ
D	3015	G2060004	DIODE	1SS270TJ
D	3016	G2060004	DIODE	1SS270TJ
D	3017	G2060004	DIODE	1SS270TJ
D	3018	G2060004	DIODE	1SS270TJ
D	3019	G2060004	DIODE	1SS270TJ
D	3020	G2060004	DIODE	1SS270TJ
D	3021	G2060004	DIODE	1SS270TJ
D	3022	G2060004	DIODE	1SS270TJ
D	3023	G2060004	DIODE	1SS270TJ
D	3024	G2060004	DIODE	1SS270TJ
D	3025	G2060004	DIODE	1SS270TJ
D	3026	G2060004	DIODE	1SS270TJ
D	3027	G2060004	DIODE	1SS270TJ
D	3028	G2090188	DIODE	HZ5C1
D	3029	G2090188	DIODE	HZ5C1
D	3030	G2060004	DIODE	1SS270TJ
D	3031	G2060004	DIODE	1SS270TJ
D	3032	G2060004	DIODE	1SS270TJ
D	3033	G2060004	DIODE	1SS270TJ
D	3034	G2060004	DIODE	1SS270TJ
D	3035	G2060004	DIODE	1SS270TJ
D	3036	G2060004	DIODE	1SS270TJ
D	3037	G2060004	DIODE	1SS270TJ
D	3038	G2060004	DIODE	1SS270TJ
D	3039	G2060004	DIODE	1SS270TJ
D	3042	G2060004	DIODE	1SS270TJ
D	3043	G2060004	DIODE	1SS270TJ
D	3044	G2060004	DIODE	1SS270TJ
D	3045	G2060004	DIODE	1SS270TJ
D	3047	G2090384	DIODE	HZ7C2
D	3048	G2060004	DIODE	1SS270TJ
D	3049	G2060004	DIODE	1SS270TJ
D	3050	G2060004	DIODE	1SS270TJ
D	3051	G2060004	DIODE	1SS270TJ
D	3052	G2060004	DIODE	1SS270TJ
D	3054	G2060004	DIODE	1SS270TJ
D	3055	G2090149	DIODE	HZ12B2
D	3056	G2090149	DIODE	HZ12B2
D	3057	G9090007	VARIABLE MV-12	MV-12 (KB265)
D	3058	G2060004	DIODE	1SS270TJ
D	3059	G2060004	DIODE	1SS270TJ
D	3062	G2060004	DIODE	1SS270TJ
D	3063	G2060004	DIODE	1SS270TJ
D	3064	G2060004	DIODE	1SS270TJ
D	3065	G2060004	DIODE	1SS270TJ
D	3066	G2060004	DIODE	1SS270TJ
D	3067	G2060004	DIODE	1SS270TJ
D	3068	G2060004	DIODE	1SS270TJ
D	3069	G2060004	DIODE	1SS270TJ
D	3070	G2060004	DIODE	1SS270TJ
D	3071	G2060004	DIODE	1SS270TJ
D	3072	G2060004	DIODE	1SS270TJ
D	3073	G2090217	DIODE	HZ3C1
J	3001	P0090621	CONNECTOR	SC25-02WS
J	3002	P1090630	CONNECTOR	JPJ2043-01-211
J	3003	P0090622	CONNECTOR	SC25-03WS
J	3004	P0090621	CONNECTOR	SC25-02WS
J	3005	P0090621	CONNECTOR	SC25-02WS
J	3006	P0090621	CONNECTOR	SC25-02WS
J	3007	P0090622	CONNECTOR	SC25-03WS
J	3008	P1090255	CONNECTOR	TMP-JA
J	3010	P0090621	CONNECTOR	SC25-02WS
J	3011	P0090624	CONNECTOR	SC25-05WS
J	3012	P1090255	CONNECTOR	TMP-JA
J	3013	P0090621	CONNECTOR	SC25-02WS
J	3014	P0090626	CONNECTOR	SC25-07WS
J	3015	P0090621	CONNECTOR	SC25-02WS
J	3016	P0090621	CONNECTOR	SC25-02WS
J	3017	P0090621	CONNECTOR	SC25-02WS
J	3018	P0090622	CONNECTOR	SC25-03WS
J	3019	P0090627	CONNECTOR	SC25-08WS
J	3020	P0090623	CONNECTOR	SC25-04WS
J	3021	P0090629	CONNECTOR	SC25-10WS
J	3022	P0090621	CONNECTOR	SC25-02WS

For Service Manuals Contact
MAURITRON TECHNICAL SERVICES
 8 Cherry Tree Rd, Chinnor
 Oxon OX9 4QY
 Tel: 01844-351694 Fax: 01844-352554
 Email: enquiries@mauritron.co.uk

AF Unit Parts List

ADD	CODE NO	DESCRIPTION	DEVICE	TYP VAL	
J	3023	P0090625	CONNECTOR	SC25-06WS	
J	3024	P0090626	CONNECTOR	SC25-07WS	
J	3025	P0090621	CONNECTOR	SC25-02WS	
J	3026	P0090624	CONNECTOR	SC25-05WS	
J	3027	P1090351	CONNECTOR	S-G4617#03	
J	3029	P1090645	CONNECTOR	TCS5073-14-4151	
J	3030	P1090646	CONNECTOR	TCS5073-15-4151	
J	3031	P1090648	CONNECTOR	TCS5073-17-4151	
J	3032	P1090647	CONNECTOR	TCS5073-16-4151	
J	3033	P0090623	CONNECTOR	SC25-04WS	
J	3034	P0090624	CONNECTOR	SC25-05WS	
J	3035	P0090621	CONNECTOR	SC25-02WS	
J	3036	P0090624	CONNECTOR	SC25-05WS	
J	3037	P0090622	CONNECTOR	SC25-03WS	
J	3039	P0090622	CONNECTOR	SC25-03WS	
J	3040	P1090546	CONNECTOR	HSJ0916-01-010	
J	3042	P0090624	CONNECTOR	SC25-05WS	
J	3043	P0090622	CONNECTOR	SC25-03WS	
J	3044	P0090621	CONNECTOR	SC25-02WS	
J	3045	P0090622	CONNECTOR	SC25-03WS	
J	3046	P0090621	CONNECTOR	SC25-02WS	
J	3047	P1090350	CONNECTOR	SG8035#01	
J	3048	P0090621	CONNECTOR	SC25-02WS	
J	3049	P0090625	CONNECTOR	SC25-06WS	
J	3051	P0090624	CONNECTOR	SC25-05WS	
J	3052	P0090622	CONNECTOR	SC25-03WS	
J	3053	P0090622	CONNECTOR	SC25-03WS	
L	3001	L1790051	M. RFC	LAP02TA2R7K	2.7u
L	3002	L1790058	M. RFC	LAP02TA100K	10uH
L	3003	L1790058	M. RFC	LAP02TA100K	10uH
L	3004	L1190189	M. RFC	LAL03NA102K	1mH
L	3005	L1190189	M. RFC	LAL03NA102K	1mH
L	3006	L1790072	M. RFC	LAP02TA151K	150uH
L	3007	L1790072	M. RFC	LAP02TA151K	150uH
L	3008	L1790071	M. RFC	LAP02TA121K	120uH
L	3009	L1790070	M. RFC	LAP02TA101K	100uH
L	3010	L1190090	M. RFC	LAL04NA102K	1mH
L	3011	L1190090	M. RFC	LAL04NA102K	1mH
Q	3001	G1090739	IC	MC145163SL	
Q	3002	G3327127G	TRANSISTOR	2SC2712GR TE85R	
Q	3003	G3327127G	TRANSISTOR	2SC2712GR TE85R	
Q	3004	G1090101	IC	UPC1037H	
Q	3005	G3327127G	TRANSISTOR	2SC2712GR TE85R	
Q	3006	G3327127G	TRANSISTOR	2SC2712GR TE85R	
Q	3007	G3327127G	TRANSISTOR	2SC2712GR TE85R	
Q	3008	G1090101	IC	UPC1037H	
Q	3010	G3327127G	TRANSISTOR	2SC2712GR TE85R	
Q	3011	G3327127G	TRANSISTOR	2SC2712GR TE85R	
Q	3012	G3327127G	TRANSISTOR	2SC2712GR TE85R	
Q	3013	G1090697	IC	M54455L	
Q	3014	G3327127G	TRANSISTOR	2SC2712GR TE85R	
Q	3015	G1090649	IC	M5218L	
Q	3016	G1090649	IC	M5218L	
Q	3017	G1090283	IC	UPD4066BC	
Q	3018	G3070006	TRANSISTOR	FA1A4P-T2B	
Q	3019	G3801607F	FET	2SK160-T2B K6	
Q	3020	G3327127G	TRANSISTOR	2SC2712GR TE85R	
Q	3021	G3070006	TRANSISTOR	FA1A4P-T2B	
Q	3022	G3070006	TRANSISTOR	FA1A4P-T2B	
Q	3023	G1090854	IC	M51523AL	
Q	3024	G1090854	IC	M51523AL	
Q	3025	G1090283	IC	UPD4066BC	
Q	3026	G3070006	TRANSISTOR	FA1A4P-T2B	
Q	3027	G3406670C	TRANSISTOR	2SD667C	
Q	3028	G3327127G	TRANSISTOR	2SC2712GR TE85R	
Q	3029	G1090769	IC	TDA2003	
Q	3030	G3327127G	TRANSISTOR	2SC2712GR TE85R	
Q	3031	G1090101	IC	UPC1037H	
Q	3032	G3327127G	TRANSISTOR	2SC2712GR TE85R	
Q	3033	G3070006	TRANSISTOR	FA1A4P-T2B	
Q	3034	G3327127G	TRANSISTOR	2SC2712GR TE85R	
Q	3035	G3327127G	TRANSISTOR	2SC2712GR TE85R	
Q	3036	G3070006	TRANSISTOR	FA1A4P-T2B	
Q	3037	G3070006	TRANSISTOR	FA1A4P-T2B	
Q	3038	G3070006	TRANSISTOR	FA1A4P-T2B	
Q	3039	G3112830D	TRANSISTOR	2SA1283D	
Q	3040	G3112830D	TRANSISTOR	2SA1283D	
Q	3041	G1090649	IC	M5218L	
Q	3042	G1090649	IC	M5218L	
Q	3043	G1090283	IC	UPD4066BC	
Q	3044	G3327127G	TRANSISTOR	2SC2712GR TE85R	
Q	3045	G1090154	IC	NE567N	
Q	3046	G3070006	TRANSISTOR	FA1A4P-T2B	

AF Unit Parts List

ADD	CODE NO	DESCRIPTION	DEVICE	TYP	VAL
Q 3047	G3070011	TRANSISTOR	FN1A4P-T2B		
Q 3048	G3327127G	TRANSISTOR	2SC2712GR TE85R		
Q 3049	G3327127G	TRANSISTOR	2SC2712GR TE85R		
Q 3050	G3327127G	TRANSISTOR	2SC2712GR TE85R		
Q 3051	G3327127G	TRANSISTOR	2SC2712GR TE85R		
Q 3052	G3327127G	TRANSISTOR	2SC2712GR TE85R		
Q 3054	G3327127G	TRANSISTOR	2SC2712GR TE85R		
Q 3055	G3327127G	TRANSISTOR	2SC2712GR TE85R		
Q 3056	G1090999	IC	MB8854-1244M		
Q 3057	G1090068	IC	MC14011BCP		
Q 3058	G3070006	TRANSISTOR	FA1A4P-T2B		
Q 3059	G3070011	TRANSISTOR	FN1A4P-T2B		
Q 3060	G3070006	TRANSISTOR	FA1A4P-T2B		
Q 3061	G3070011	TRANSISTOR	FN1A4P-T2B		
Q 3062	G3070006	TRANSISTOR	FA1A4P-T2B		
Q 3063	G3070006	TRANSISTOR	FA1A4P-T2B		
Q 3064	G1091001	IC	MB88202H-635M		
Q 3065	G1091000	IC	MB88202H-634M		
Q 3066	G1090088	IC	MC14028BCP		
Q 3067	G3070007	TRANSISTOR	FA1F4N-T2B		
Q 3068	G3070006	TRANSISTOR	FA1A4P-T2B		
Q 3069	G3327127G	TRANSISTOR	2SC2712GR TE85R		
Q 3070	G3070006	TRANSISTOR	FA1A4P-T2B		
Q 3071	G3070006	TRANSISTOR	FA1A4P-T2B		
Q 3072	G1090649	IC	M5218L		
Q 3073	G3327127G	TRANSISTOR	2SC2712GR TE85R		
Q 3074	G1090649	IC	M5218L		
Q 3075	G1090649	IC	M5218L		
Q 3076	G1090649	IC	M5218L		
Q 3077	G1090649	IC	M5218L		
Q 3078	G3070006	TRANSISTOR	FA1A4P-T2B		
Q 3079	G3327127G	TRANSISTOR	2SC2712GR TE85R		
Q 3080	G3327127G	TRANSISTOR	2SC2712GR TE85R		
Q 3081	G3327127G	TRANSISTOR	2SC2712GR TE85R		
Q 3082	G1090649	IC	M5218L		
Q 3083	G3070006	TRANSISTOR	FA1A4P-T2B		
Q 3084	G3070011	TRANSISTOR	FN1A4P-T2B		
Q 3087	G1090991	IC	M51943BML-301		
R 3001	J24205682	CHIP RES.	RMC1/10T 682J	6.8K	1/10W
R 3002	J24205222	CHIP RES.	RMC1/10T 222J	2.2K	1/10W
R 3003	J24205104	CHIP RES.	RMC1/10T 104J	100K	1/10W
R 3004	J24205103	CHIP RES.	RMC1/10T 103J	10K	1/10W
R 3005	J24205222	CHIP RES.	RMC1/10T 222J	2.2K	1/10W
R 3006	J24205101	CHIP RES.	RMC1/10T 101J	100	1/10W
R 3007	J24205104	CHIP RES.	RMC1/10T 104J	100K	1/10W
R 3008	J24205101	CHIP RES.	RMC1/10T 101J	100	1/10W
R 3009	J24205471	CHIP RES.	RMC1/10T 471J	470	1/10W
R 3010	J24205101	CHIP RES.	RMC1/10T 101J	100	1/10W
R 3011	J24205000	CHIP RES.	RMC1/10T 000J	0	1/10W
R 3012	J24205471	CHIP RES.	RMC1/10T 471J	470	1/10W
R 3013	J24205102	CHIP RES.	RMC1/10T 102J	1K	1/10W
R 3014	J24205223	CHIP RES.	RMC1/10T 223J	22K	1/10W
R 3015	J24205101	CHIP RES.	RMC1/10T 101J	100	1/10W
R 3017	J24205103	CHIP RES.	RMC1/10T 103J	10K	1/10W
R 3018	J24205104	CHIP RES.	RMC1/10T 104J	100K	1/10W
R 3019	J24205101	CHIP RES.	RMC1/10T 101J	100	1/10W
R 3020	J24205471	CHIP RES.	RMC1/10T 471J	470	1/10W
R 3021	J24205104	CHIP RES.	RMC1/10T 104J	100K	1/10W
R 3022	J24205101	CHIP RES.	RMC1/10T 101J	100	1/10W
R 3023	J24205471	CHIP RES.	RMC1/10T 471J	470	1/10W
R 3024	J24205101	CHIP RES.	RMC1/10T 101J	100	1/10W
R 3025	J24205271	CHIP RES.	RMC1/10T 271J	270	1/10W
R 3026	J24205391	CHIP RES.	RMC1/10T 391J	390	1/10W
R 3031	J24205104	CHIP RES.	RMC1/10T 104J	100K	1/10W
R 3032	J24205471	CHIP RES.	RMC1/10T 471J	470	1/10W
R 3033	J24205101	CHIP RES.	RMC1/10T 101J	100	1/10W
R 3034	J24205560	CHIP RES.	RMC1/10T 560J	56	1/10W
R 3035	J24205104	CHIP RES.	RMC1/10T 104J	100K	1/10W
R 3036	J24205101	CHIP RES.	RMC1/10T 101J	100	1/10W
R 3037	J24205471	CHIP RES.	RMC1/10T 471J	470	1/10W
R 3038	J24205104	CHIP RES.	RMC1/10T 104J	100K	1/10W
R 3039	J24205101	CHIP RES.	RMC1/10T 101J	100	1/10W
R 3040	J24205471	CHIP RES.	RMC1/10T 471J	470	1/10W
R 3041	J24205471	CHIP RES.	RMC1/10T 471J	470	1/10W
R 3042	J24205561	CHIP RES.	RMC1/10T 561J	560	1/10W
R 3043	J24205223	CHIP RES.	RMC1/10T 223J	22K	1/10W
R 3044	J24205153	CHIP RES.	RMC1/10T 153J	15K	1/10W
R 3045	J24205472	CHIP RES.	RMC1/10T 472J	4.7K	1/10W
R 3046	J24205221	CHIP RES.	RMC1/10T 221J	220	1/10W
R 3047	J24205471	CHIP RES.	RMC1/10T 471J	470	1/10W
R 3048	J24205471	CHIP RES.	RMC1/10T 471J	470	1/10W
R 3049	J24205104	CHIP RES.	RMC1/10T 104J	100K	1/10W
R 3050	J24205101	CHIP RES.	RMC1/10T 101J	100	1/10W

For Service Manuals Contact
MAURITRON TECHNICAL SERVICES
 8 Cherry Tree Rd, Chinnor
 Oxon OX9 4QY
 Tel: 01844-351694 Fax: 01844-352554
 Email: enquiries@mauritron.co.uk

AF Unit Parts List

ADD	CODE NO	DESCRIPTION	DEVICE		TYP	VAL
R 3051	J24205471	CHIP RES.	RMC1/10T 471J	470	1/10W	
R 3052	J24205153	CHIP RES.	RMC1/10T 153J	15K	1/10W	
R 3053	J24205153	CHIP RES.	RMC1/10T 153J	15K	1/10W	
R 3054	J24205473	CHIP RES.	RMC1/10T 473J	47K	1/10W	
R 3055	J24205103	CHIP RES.	RMC1/10T 103J	10K	1/10W	
R 3056	J24205103	CHIP RES.	RMC1/10T 103J	10K	1/10W	
R 3057	J24205473	CHIP RES.	RMC1/10T 473J	47K	1/10W	
R 3058	J24205123	CHIP RES.	RMC1/10T 123J	12K	1/10W	
R 3059	J24205123	CHIP RES.	RMC1/10T 123J	12K	1/10W	
R 3060	J24205473	CHIP RES.	RMC1/10T 473J	47K	1/10W	
R 3061	J24205102	CHIP RES.	RMC1/10T 102J	1K	1/10W	
R 3062	J24205682	CHIP RES.	RMC1/10T 682J	6.8K	1/10W	
R 3063	J24205103	CHIP RES.	RMC1/10T 103J	10K	1/10W	
R 3064	J24205103	CHIP RES.	RMC1/10T 103J	10K	1/10W	
R 3065	J24205474	CHIP RES.	RMC1/10T 474J	470K	1/10W	
R 3066	J24205332	CHIP RES.	RMC1/10T 332J	3.3K	1/10W	
R 3067	J24205101	CHIP RES.	RMC1/10T 101J	100	1/10W	
R 3068	J24205223	CHIP RES.	RMC1/10T 223J	22K	1/10W	
R 3069	J24205473	CHIP RES.	RMC1/10T 473J	47K	1/10W	
R 3070	J24205104	CHIP RES.	RMC1/10T 104J	100K	1/10W	
R 3071	J24205104	CHIP RES.	RMC1/10T 104J	100K	1/10W	
R 3072	J24205104	CHIP RES.	RMC1/10T 104J	100K	1/10W	
R 3073	J24205104	CHIP RES.	RMC1/10T 104J	100K	1/10W	
R 3074	J24205104	CHIP RES.	RMC1/10T 104J	100K	1/10W	
R 3075	J24205104	CHIP RES.	RMC1/10T 104J	100K	1/10W	
R 3076	J24205104	CHIP RES.	RMC1/10T 104J	100K	1/10W	
R 3077	J24205104	CHIP RES.	RMC1/10T 104J	100K	1/10W	
R 3078	J24205473	CHIP RES.	RMC1/10T 473J	47K	1/10W	
R 3079	J24205104	CHIP RES.	RMC1/10T 104J	100K	1/10W	
R 3080	J24205683	CHIP RES.	RMC1/10T 683J	68K	1/10W	
R 3081	J24205104	CHIP RES.	RMC1/10T 104J	100K	1/10W	
R 3083	J24205473	CHIP RES.	RMC1/10T 473J	47K	1/10W	
R 3084	J24205472	CHIP RES.	RMC1/10T 472J	4.7K	1/10W	
R 3085	J24205223	CHIP RES.	RMC1/10T 223J	22K	1/10W	
R 3086	J24205683	CHIP RES.	RMC1/10T 683J	68K	1/10W	
R 3087	J24205101	CHIP RES.	RMC1/10T 101J	100	1/10W	
R 3088	J24205332	CHIP RES.	RMC1/10T 332J	3.3K	1/10W	
R 3089	J24205472	CHIP RES.	RMC1/10T 472J	4.7K	1/10W	
R 3090	J24205220	CHIP RES.	RMC1/10T 220J	22	1/10W	
R 3091	J24205102	CHIP RES.	RMC1/10T 102J	1K	1/10W	
R 3092	J24205101	CHIP RES.	RMC1/10T 101J	100	1/10W	
R 3093	J24205472	CHIP RES.	RMC1/10T 472J	4.7K	1/10W	
R 3094	J24205472	CHIP RES.	RMC1/10T 472J	4.7K	1/10W	
R 3096	J24205104	CHIP RES.	RMC1/10T 104J	100K	1/10W	
R 3097	J24205102	CHIP RES.	RMC1/10T 102J	1K	1/10W	
R 3098	J24205104	CHIP RES.	RMC1/10T 104J	100K	1/10W	
R 3099	J24205101	CHIP RES.	RMC1/10T 101J	100	1/10W	
R 3100	J24205103	CHIP RES.	RMC1/10T 103J	10K	1/10W	
R 3101	J24205563	CHIP RES.	RMC1/10T 563J	56K	1/10W	
R 3103	J24205104	CHIP RES.	RMC1/10T 104J	100K	1/10W	
R 3105	J24205103	CHIP RES.	RMC1/10T 103J	10K	1/10W	
R 3106	J24205103	CHIP RES.	RMC1/10T 103J	10K	1/10W	
R 3107	J24205103	CHIP RES.	RMC1/10T 103J	10K	1/10W	
R 3108	J24205104	CHIP RES.	RMC1/10T 104J	100K	1/10W	
R 3109	J07225221	CARBON FILM RES.	RD16TPJ221 220	220	1/6W	
R 3110	J07225229	CARBON FILM RES.	RD16TPJ2R2 2.2	2.2	1/6W	
R 3111	J07225010	CARBON FILM RES.	RD16TPJ010 1	1	1/6W	
R 3113	J24205222	CHIP RES.	RMC1/10T 222J	2.2K	1/10W	
R 3116	J24205103	CHIP RES.	RMC1/10T 103J	10K	1/10W	
R 3117	J24205101	CHIP RES.	RMC1/10T 101J	100	1/10W	
R 3118	J24205101	CHIP RES.	RMC1/10T 101J	100	1/10W	
R 3119	J24205101	CHIP RES.	RMC1/10T 101J	100	1/10W	
R 3120	J24205683	CHIP RES.	RMC1/10T 683J	68K	1/10W	
R 3121	J24205221	CHIP RES.	RMC1/10T 221J	220	1/10W	
R 3122	J24205221	CHIP RES.	RMC1/10T 221J	220	1/10W	
R 3123	J24205151	CHIP RES.	RMC1/10T 151J	150	1/10W	
R 3124	J24205101	CHIP RES.	RMC1/10T 101J	100	1/10W	
R 3125	J24205102	CHIP RES.	RMC1/10T 102J	1K	1/10W	
R 3126	J24205222	CHIP RES.	RMC1/10T 222J	2.2K	1/10W	
R 3127	J24205221	CHIP RES.	RMC1/10T 221J	220	1/10W	
R 3128	J24205153	CHIP RES.	RMC1/10T 153J	15K	1/10W	
R 3129	J24205101	CHIP RES.	RMC1/10T 101J	100	1/10W	
R 3130	J24205473	CHIP RES.	RMC1/10T 473J	47K	1/10W	
R 3131	J24205101	CHIP RES.	RMC1/10T 101J	100	1/10W	
R 3132	J24205332	CHIP RES.	RMC1/10T 332J	3.3K	1/10W	
R 3133	J24205683	CHIP RES.	RMC1/10T 683J	68K	1/10W	
R 3134	J24205181	CHIP RES.	RMC1/10T 181J	180	1/10W	
R 3135	J24205102	CHIP RES.	RMC1/10T 102J	1K	1/10W	
R 3136	J24205223	CHIP RES.	RMC1/10T 223J	22K	1/10W	
R 3139	J24205473	CHIP RES.	RMC1/10T 473J	47K	1/10W	
R 3140	J24205102	CHIP RES.	RMC1/10T 102J	1K	1/10W	
R 3141	J24205472	CHIP RES.	RMC1/10T 472J	4.7K	1/10W	
R 3142	J24205102	CHIP RES.	RMC1/10T 102J	1K	1/10W	

AF Unit Parts List

ADD	CODE NO	DESCRIPTION	DEVICE	TYP VAL
R 3143	J24205101	CHIP RES.	RMC1/10T 101J	100 1/10W
R 3144	J24205222	CHIP RES.	RMC1/10T 222J	2.2K 1/10W
R 3145	J24205104	CHIP RES.	RMC1/10T 104J	100K 1/10W
R 3147	J24205223	CHIP RES.	RMC1/10T 223J	22K 1/10W
R 3148	J24205183	CHIP RES.	RMC1/10T 183J	18K 1/10W
R 3149	J24205820	CHIP RES.	RMC1/10T 820J	82 1/10W
R 3150	J24205471	CHIP RES.	RMC1/10T 471J	470 1/10W
R 3151	J24205103	CHIP RES.	RMC1/10T 103J	10K 1/10W
R 3152	J24205102	CHIP RES.	RMC1/10T 102J	1K 1/10W
R 3153	J24205104	CHIP RES.	RMC1/10T 104J	100K 1/10W
R 3154	J24205104	CHIP RES.	RMC1/10T 104J	100K 1/10W
R 3155	J24205472	CHIP RES.	RMC1/10T 472J	4.7K 1/10W
R 3156	J24205104	CHIP RES.	RMC1/10T 104J	100K 1/10W
R 3157	J24205333	CHIP RES.	RMC1/10T 333J	33K 1/10W
R 3158	J24205225	CHIP RES.	RMC1/10T 225J	2.2M 1/10W
R 3159	J24205225	CHIP RES.	RMC1/10T 225J	2.2M 1/10W
R 3160	J24205471	CHIP RES.	RMC1/10T 471J	470 1/10W
R 3161	J24205102	CHIP RES.	RMC1/10T 102J	1K 1/10W
R 3162	J24205473	CHIP RES.	RMC1/10T 473J	47K 1/10W
R 3163	J24205473	CHIP RES.	RMC1/10T 473J	47K 1/10W
R 3164	J24205102	CHIP RES.	RMC1/10T 102J	1K 1/10W
R 3165	J24205103	CHIP RES.	RMC1/10T 103J	10K 1/10W
R 3166	J24205473	CHIP RES.	RMC1/10T 473J	47K 1/10W
R 3167	J24205473	CHIP RES.	RMC1/10T 473J	47K 1/10W
R 3168	J24205473	CHIP RES.	RMC1/10T 473J	47K 1/10W
R 3170	J24205103	CHIP RES.	RMC1/10T 103J	10K 1/10W
R 3171	J24205104	CHIP RES.	RMC1/10T 104J	100K 1/10W
R 3172	J24205101	CHIP RES.	RMC1/10T 101J	100 1/10W
R 3173	J24205102	CHIP RES.	RMC1/10T 102J	1K 1/10W
R 3174	J24205331	CHIP RES.	RMC1/10T 331J	330 1/10W
R 3175	J24205101	CHIP RES.	RMC1/10T 101J	100 1/10W
R 3176	J24205104	CHIP RES.	RMC1/10T 104J	100K 1/10W
R 3177	J24205102	CHIP RES.	RMC1/10T 102J	1K 1/10W
R 3178	J24205103	CHIP RES.	RMC1/10T 103J	10K 1/10W
R 3179	J24205102	CHIP RES.	RMC1/10T 102J	1K 1/10W
R 3180	J24205104	CHIP RES.	RMC1/10T 104J	100K 1/10W
R 3181	J24205101	CHIP RES.	RMC1/10T 101J	100 1/10W
R 3182	J24205102	CHIP RES.	RMC1/10T 102J	1K 1/10W
R 3183	J24205104	CHIP RES.	RMC1/10T 104J	100K 1/10W
R 3184	J24205101	CHIP RES.	RMC1/10T 101J	100 1/10W
R 3185	J24205102	CHIP RES.	RMC1/10T 102J	1K 1/10W
R 3186	J24205104	CHIP RES.	RMC1/10T 104J	100K 1/10W
R 3187	J24205101	CHIP RES.	RMC1/10T 101J	100 1/10W
R 3188	J24205102	CHIP RES.	RMC1/10T 102J	1K 1/10W
R 3189	J24205102	CHIP RES.	RMC1/10T 102J	1K 1/10W
R 3190	J24205104	CHIP RES.	RMC1/10T 104J	100K 1/10W
R 3191	J24205101	CHIP RES.	RMC1/10T 101J	100 1/10W
R 3192	J24205102	CHIP RES.	RMC1/10T 102J	1K 1/10W
R 3193	J24205102	CHIP RES.	RMC1/10T 102J	1K 1/10W
R 3194	J24205104	CHIP RES.	RMC1/10T 104J	100K 1/10W
R 3195	J24205101	CHIP RES.	RMC1/10T 101J	100 1/10W
R 3196	J24205102	CHIP RES.	RMC1/10T 102J	1K 1/10W
R 3201	J24205102	CHIP RES.	RMC1/10T 102J	1K 1/10W
R 3202	J24205102	CHIP RES.	RMC1/10T 102J	1K 1/10W
R 3203	J24205102	CHIP RES.	RMC1/10T 102J	1K 1/10W
R 3204	J24205102	CHIP RES.	RMC1/10T 102J	1K 1/10W
R 3205	J24205223	CHIP RES.	RMC1/10T 223J	22K 1/10W
R 3206	J24205103	CHIP RES.	RMC1/10T 103J	10K 1/10W
R 3207	J24205334	CHIP RES.	RMC1/10T 334J	330K 1/10W
R 3208	J24205104	CHIP RES.	RMC1/10T 104J	100K 1/10W
R 3209	J24205103	CHIP RES.	RMC1/10T 103J	10K 1/10W
R 3210	J24205104	CHIP RES.	RMC1/10T 104J	100K 1/10W
R 3211	J24205104	CHIP RES.	RMC1/10T 104J	100K 1/10W
R 3212	J24205104	CHIP RES.	RMC1/10T 104J	100K 1/10W
R 3213	J24205103	CHIP RES.	RMC1/10T 103J	10K 1/10W
R 3214	J24205103	CHIP RES.	RMC1/10T 103J	10K 1/10W
R 3219	J24205473	CHIP RES.	RMC1/10T 473J	47K 1/10W
R 3224	J24205473	CHIP RES.	RMC1/10T 473J	47K 1/10W
R 3225	J24205103	CHIP RES.	RMC1/10T 103J	10K 1/10W
R 3226	J24205103	CHIP RES.	RMC1/10T 103J	10K 1/10W
R 3227	J24205333	CHIP RES.	RMC1/10T 333J	33K 1/10W
R 3228	J24205103	CHIP RES.	RMC1/10T 103J	10K 1/10W
R 3229	J24205103	CHIP RES.	RMC1/10T 103J	10K 1/10W
R 3230	J24205153	CHIP RES.	RMC1/10T 153J	15K 1/10W
R 3231	J24205153	CHIP RES.	RMC1/10T 153J	15K 1/10W
R 3232	J24205102	CHIP RES.	RMC1/10T 102J	1K 1/10W
R 3233	J24205103	CHIP RES.	RMC1/10T 103J	10K 1/10W
R 3234	J24205103	CHIP RES.	RMC1/10T 103J	10K 1/10W
R 3235	J24205102	CHIP RES.	RMC1/10T 102J	1K 1/10W
R 3237	J24205683	CHIP RES.	RMC1/10T 683J	68K 1/10W
R 3238	J24205104	CHIP RES.	RMC1/10T 104J	100K 1/10W
R 3239	J24205103	CHIP RES.	RMC1/10T 103J	10K 1/10W
R 3240	J24205104	CHIP RES.	RMC1/10T 104J	100K 1/10W

AF Unit Parts List

ADD	CODE NO	DESCRIPTION	DEVICE	TYP	VAL
R 3241	J24205224	CHIP RES.	RMC1/10T 224J	220K	1/10W
R 3242	J24205332	CHIP RES.	RMC1/10T 332J	3.3K	1/10W
R 3243	J24205472	CHIP RES.	RMC1/10T 472J	4.7K	1/10W
R 3244	J24205105	CHIP RES.	RMC1/10T 105J	1M	1/10W
R 3245	J24205332	CHIP RES.	RMC1/10T 332J	3.3K	1/10W
R 3246	J24205103	CHIP RES.	RMC1/10T 103J	10K	1/10W
R 3248	J24205473	CHIP RES.	RMC1/10T 473J	47K	1/10W
R 3249	J24205103	CHIP RES.	RMC1/10T 103J	10K	1/10W
R 3250	J24205392	CHIP RES.	RMC1/10T 392J	3.9K	1/10W
R 3251	J24205473	CHIP RES.	RMC1/10T 473J	47K	1/10W
R 3252	J24205104	CHIP RES.	RMC1/10T 104J	100K	1/10W
R 3253	J24205104	CHIP RES.	RMC1/10T 104J	100K	1/10W
R 3255	J24205104	CHIP RES.	RMC1/10T 104J	100K	1/10W
R 3256	J24205154	CHIP RES.	RMC1/10T 154J	150K	1/10W
R 3257	J24205104	CHIP RES.	RMC1/10T 104J	100K	1/10W
R 3258	J24205154	CHIP RES.	RMC1/10T 154J	150K	1/10W
R 3259	J24205333	CHIP RES.	RMC1/10T 333J	33K	1/10W
R 3260	J24205154	CHIP RES.	RMC1/10T 154J	150K	1/10W
R 3261	J24205104	CHIP RES.	RMC1/10T 104J	100K	1/10W
R 3262	J24205154	CHIP RES.	RMC1/10T 154J	150K	1/10W
R 3263	J24205333	CHIP RES.	RMC1/10T 333J	33K	1/10W
R 3264	J24205473	CHIP RES.	RMC1/10T 473J	47K	1/10W
R 3265	J24205473	CHIP RES.	RMC1/10T 473J	47K	1/10W
R 3266	J24205152	CHIP RES.	RMC1/10T 152J	1.5K	1/10W
R 3267	J24205103	CHIP RES.	RMC1/10T 103J	10K	1/10W
R 3268	J24205103	CHIP RES.	RMC1/10T 103J	10K	1/10W
R 3269	J24205224	CHIP RES.	RMC1/10T 224J	220K	1/10W
R 3270	J24205224	CHIP RES.	RMC1/10T 224J	220K	1/10W
R 3271	J24205152	CHIP RES.	RMC1/10T 152J	1.5K	1/10W
R 3272	J24205222	CHIP RES.	RMC1/10T 222J	2.2K	1/10W
R 3273	J24205222	CHIP RES.	RMC1/10T 222J	2.2K	1/10W
R 3274	J24205334	CHIP RES.	RMC1/10T 334J	330K	1/10W
R 3275	J24205333	CHIP RES.	RMC1/10T 333J	33K	1/10W
R 3276	J24205224	CHIP RES.	RMC1/10T 224J	220K	1/10W
R 3277	J24205473	CHIP RES.	RMC1/10T 473J	47K	1/10W
R 3278	J24205104	CHIP RES.	RMC1/10T 104J	100K	1/10W
R 3279	J24205104	CHIP RES.	RMC1/10T 104J	100K	1/10W
R 3280	J24205473	CHIP RES.	RMC1/10T 473J	47K	1/10W
R 3281	J24205472	CHIP RES.	RMC1/10T 472J	4.7K	1/10W
R 3282	J24205152	CHIP RES.	RMC1/10T 152J	1.5K	1/10W
R 3283	J24205682	CHIP RES.	RMC1/10T 682J	6.8K	1/10W
R 3284	J24205102	CHIP RES.	RMC1/10T 102J	1K	1/10W
R 3286	J24205101	CHIP RES.	RMC1/10T 101J	100	1/10W
R 3287	J24205473	CHIP RES.	RMC1/10T 473J	47K	1/10W
R 3288	J24205684	CHIP RES.	RMC1/10T 684J	680K	1/10W
R 3289	J24205472	CHIP RES.	RMC1/10T 472J	4.7K	1/10W
R 3290	J24205182	CHIP RES.	RMC1/10T 182J	1.8K	1/10W
R 3291	J24205102	CHIP RES.	RMC1/10T 102J	1K	1/10W
R 3292	J24205103	CHIP RES.	RMC1/10T 103J	10K	1/10W
R 3293	J24205102	CHIP RES.	RMC1/10T 102J	1K	1/10W
R 3294	J24205104	CHIP RES.	RMC1/10T 104J	100K	1/10W
R 3295	J24205331	CHIP RES.	RMC1/10T 331J	330	1/10W
R 3296	J24205221	CHIP RES.	RMC1/10T 221J	220	1/10W
R 3298	J24205104	CHIP RES.	RMC1/10T 104J	100K	1/10W
R 3300	J24205104	CHIP RES.	RMC1/10T 104J	100K	1/10W
R 3301	J24205104	CHIP RES.	RMC1/10T 104J	100K	1/10W
R 3302	J24205104	CHIP RES.	RMC1/10T 104J	100K	1/10W
R 3303	J24205104	CHIP RES.	RMC1/10T 104J	100K	1/10W
R 3304	J24205104	CHIP RES.	RMC1/10T 104J	100K	1/10W
R 3305	J24205102	CHIP RES.	RMC1/10T 102J	1K	1/10W
R 3306	J24205102	CHIP RES.	RMC1/10T 102J	1K	1/10W
R 3308	J24205102	CHIP RES.	RMC1/10T 102J	1K	1/10W
R 3309	J24205332	CHIP RES.	RMC1/10T 332J	3.3K	1/10W
R 3310	J24205560	CHIP RES.	RMC1/10T 560J	56	1/10W
R 3311	J24205332	CHIP RES.	RMC1/10T 332J	3.3K	1/10W
R 3312	J24205104	CHIP RES.	RMC1/10T 104J	100K	1/10W
R 3313	J24205103	CHIP RES.	RMC1/10T 103J	10K	1/10W
R 3314	J24205104	CHIP RES.	RMC1/10T 104J	100K	1/10W
R 3315	J24205101	CHIP RES.	RMC1/10T 101J	100	1/10W
R 3316	J24205104	CHIP RES.	RMC1/10T 104J	100K	1/10W
R 3317	J24205102	CHIP RES.	RMC1/10T 102J	1K	1/10W
R 3318	J24205103	CHIP RES.	RMC1/10T 103J	10K	1/10W
R 3319	J24205154	CHIP RES.	RMC1/10T 154J	150K	1/10W
R 3320	J24205101	CHIP RES.	RMC1/10T 101J	100	1/10W
R 3321	J24205473	CHIP RES.	RMC1/10T 473J	47K	1/10W
R 3322	J24205393	CHIP RES.	RMC1/10T 393J	39K	1/10W
R 3323	J24205103	CHIP RES.	RMC1/10T 103J	10K	1/10W
R 3324	J24205683	CHIP RES.	RMC1/10T 683J	68K	1/10W
R 3325	J24205101	CHIP RES.	RMC1/10T 101J	100	1/10W
R 3326	J24205104	CHIP RES.	RMC1/10T 104J	100K	1/10W
R 3327	J24205102	CHIP RES.	RMC1/10T 102J	1K	1/10W
R 3328	J24205333	CHIP RES.	RMC1/10T 333J	33K	1/10W
R 3329	J24205183	CHIP RES.	RMC1/10T 183J	18K	1/10W

For Service Manuals Contact
MAURITRON TECHNICAL SERVICES
 8 Cherry Tree Rd, Chinnor
 Oxon OX9 4QY
 Tel: 01844-351654 Fax: 01844-352554
 Email: enquiries@mauritron.co.uk

AF Unit Parts List

ADD	CODE NO	DESCRIPTION	DEVICE	TYP	VAL
R 3330	J24205183	CHIP RES.	RMC1/10T 183J	18K	1/10W
R 3331	J24205153	CHIP RES.	RMC1/10T 153J	15K	1/10W
R 3332	J24205153	CHIP RES.	RMC1/10T 153J	15K	1/10W
R 3333	J24205563	CHIP RES.	RMC1/10T 563J	56K	1/10W
R 3334	J24205103	CHIP RES.	RMC1/10T 103J	10K	1/10W
R 3335	J24205562	CHIP RES.	RMC1/10T 562J	5.6K	1/10W
R 3336	J24205154	CHIP RES.	RMC1/10T 154J	150K	1/10W
R 3337	J24205154	CHIP RES.	RMC1/10T 154J	150K	1/10W
R 3338	J24205563	CHIP RES.	RMC1/10T 563J	56K	1/10W
R 3339	J24205000	CHIP RES.	RMC1/10T 000J	0	1/10W
R 3340	J24205102	CHIP RES.	RMC1/10T 102J	1K	1/10W
R 3341	J24205473	CHIP RES.	RMC1/10T 473J	47K	1/10W
R 3343	J24205104	CHIP RES.	RMC1/10T 104J	100K	1/10W
R 3344	J24205104	CHIP RES.	RMC1/10T 104J	100K	1/10W
R 3345	J24205100	CHIP RES.	RMC1/10T 100J	10	1/10W
R 3346	J24205472	CHIP RES.	RMC1/10T 472J	4.7K	1/10W
R 3347	J24205153	CHIP RES.	RMC1/10T 153J	15K	1/10W
R 3348	J24205000	CHIP RES.	RMC1/10T 000J	0	1/10W
R 3350	J24205222	CHIP RES.	RMC1/10T 222J	2.2K	1/10W
R 3351	J24205103	CHIP RES.	RMC1/10T 103J	10K	1/10W
R 3352	J24205104	CHIP RES.	RMC1/10T 104J	100K	1/10W
R 3353	J24205104	CHIP RES.	RMC1/10T 104J	100K	1/10W
R 3354	J24205104	CHIP RES.	RMC1/10T 104J	100K	1/10W
R 3355	J24205221	CHIP RES.	RMC1/10T 221J	220	1/10W
R 3356	J24205122	CHIP RES.	RMC1/10T 122J	1.2K	1/10W
R 3357	J24205102	CHIP RES.	RMC1/10T 102J	1K	1/10W
R 3358	J24205102	CHIP RES.	RMC1/10T 102J	1K	1/10W
R 3359	J24205472	CHIP RES.	RMC1/10T 472J	4.7K	1/10W
R 3360	J24205101	CHIP RES.	RMC1/10T 101J	100	1/10W
R 3361	J24205101	CHIP RES.	RMC1/10T 101J	100	1/10W
R 3365	J24205102	CHIP RES.	RMC1/10T 102J	1K	1/10W
R 3366	J24205222	CHIP RES.	RMC1/10T 222J	2.2K	1/10W
RB3001	J40900172	BLOCK RES. RN3E5T0002	RN3E5T0002	RN3E5T0002	
RB3002	J40900172	BLOCK RES. RN3E5T0002	RN3E5T0002	RN3E5T0002	
S 3001	N6090064	SLIDE SWITCH	SS912		
S 3002	N6090064	SLIDE SWITCH	SS912		
S 3003	N7090012	DIP SWITCH SCS-04A	SCS-04A R66-3245		
T 3001	L0021965	COIL	R12-J763A		
T 3003	L0021484	COIL			
T 3005	L0021484	COIL			
T 3006	L0021484	COIL			
T 3007	L0020788A	COIL			
TC3001	K91000089	TRIMMER CAP.	4-1 2D3 TR6X3 VCT51G	50PF	50P
TP3001	Q5000026	TP-F	TP-F IPS-1032		
TP3002	Q5000026	TP-F	TP-F IPS-1032		
TP3003	Q5000016	TP-E/	TP-E/MS-60124		
TP3004	Q5000026	TP-F	TP-F IPS-1032		
TP3005	Q5000026	TP-F	TP-F IPS-1032		
VR3001	J51745102	POT.	H0651A007-1KB	1KB	
VR3002	J51745103	POT.	H0651A013-10KB	10KB	
VR3003	J51745103	POT.	H0651A013-10KB	10KB	
VR3004	J51745474	POT.	H0651A023-470KB	470KB	
VR3005	J51745102	POT.	H0651A007-1KB	1KB	
VR3006	J51745102	POT.	H0651A007-1KB	1KB	
VR3007	J51745103	POT.	H0651A013-10KB	10KB	
VR3008	J51745103	POT.	H0651A013-10KB	10KB	
VR3010	J51745102	POT.	H0651A007-1KB	1KB	
VR3011	J51745103	POT.	H0651A013-10KB	10KB	
VR3012	J51745103	POT.	H0651A013-10KB	10KB	
VR3013	J51745103	POT.	H0651A013-10KB	10KB	
VR3014	J51745473	POT.	H0651A017-47KB	47KB	
VR3015	J51745103	POT.	H0651A013-10KB	10KB	
VR3016	J51745103	POT.	H0651A013-10KB	10KB	
VR3017	J51745472	POT.	H0651A011-4.7KB	4.7KB	
VR3018	J51745473	POT.	H0651A017-47KB	47KB	
VR3019	J51745103	POT.	H0651A013-10KB	10KB	
VR3020	J51745473	POT.	H0651A017-47KB	47KB	
X 3001	H0102938	XTAL		12.18MHZ	
X 3002	H0102409	XTAL		7.20MHZ	

For Service Manuals Contact
MAURITRON TECHNICAL SERVICES
 8 Cherry Tree Rd, Chinnor
 Oxon OX9 4QY
 Tel: 01844-351694 Fax: 01844-352554
 Email: enquiries@mauritron.co.uk

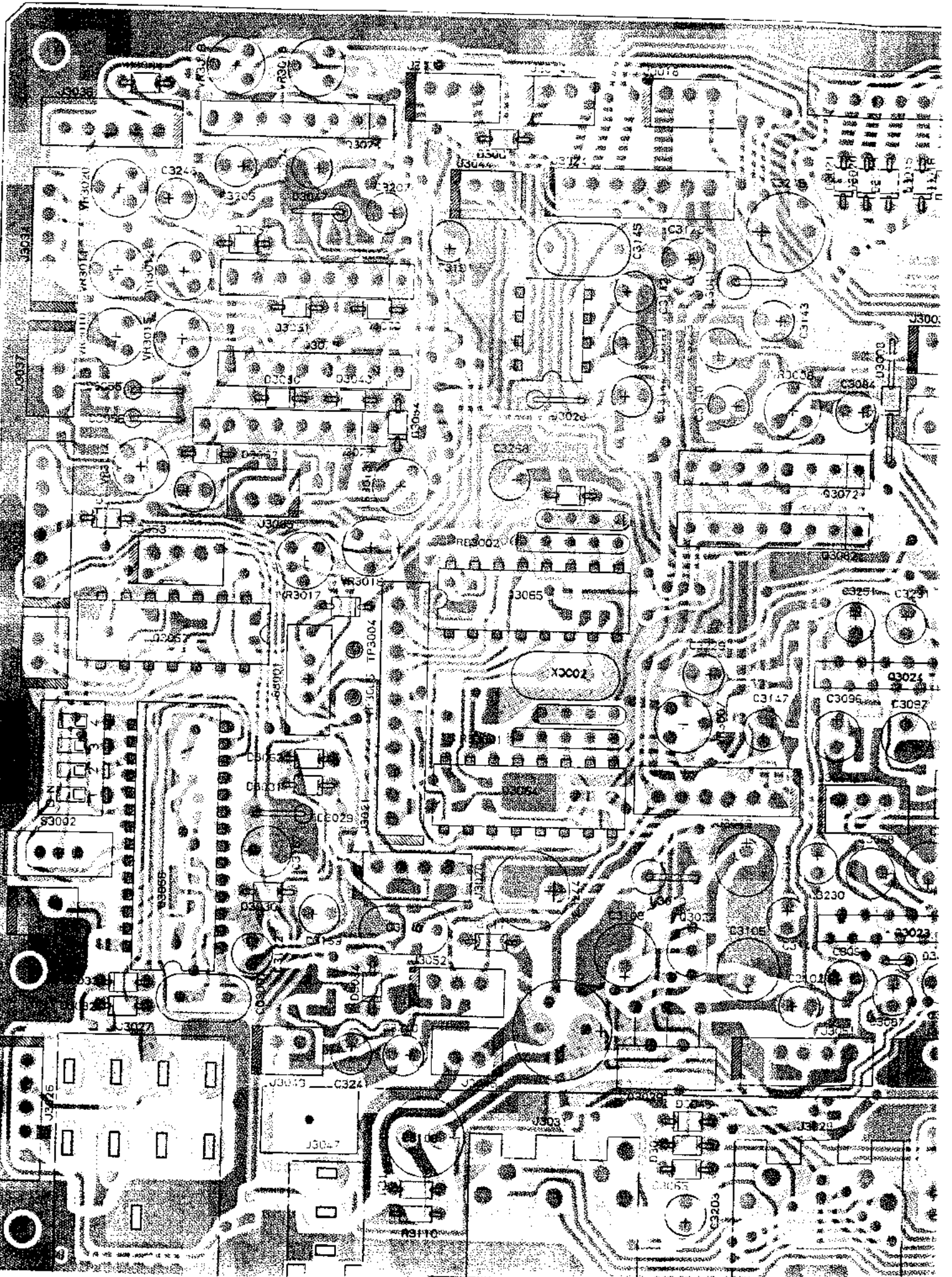

For Service Manuals Contact
MAURITRON TECHNICAL SERVICES
8 Cherry Tree Rd, Chinnor
Oxon OX9 4QY
Tel: 01844 351694 Fax: 01844 352554
Email: enquiries@mauratron.com

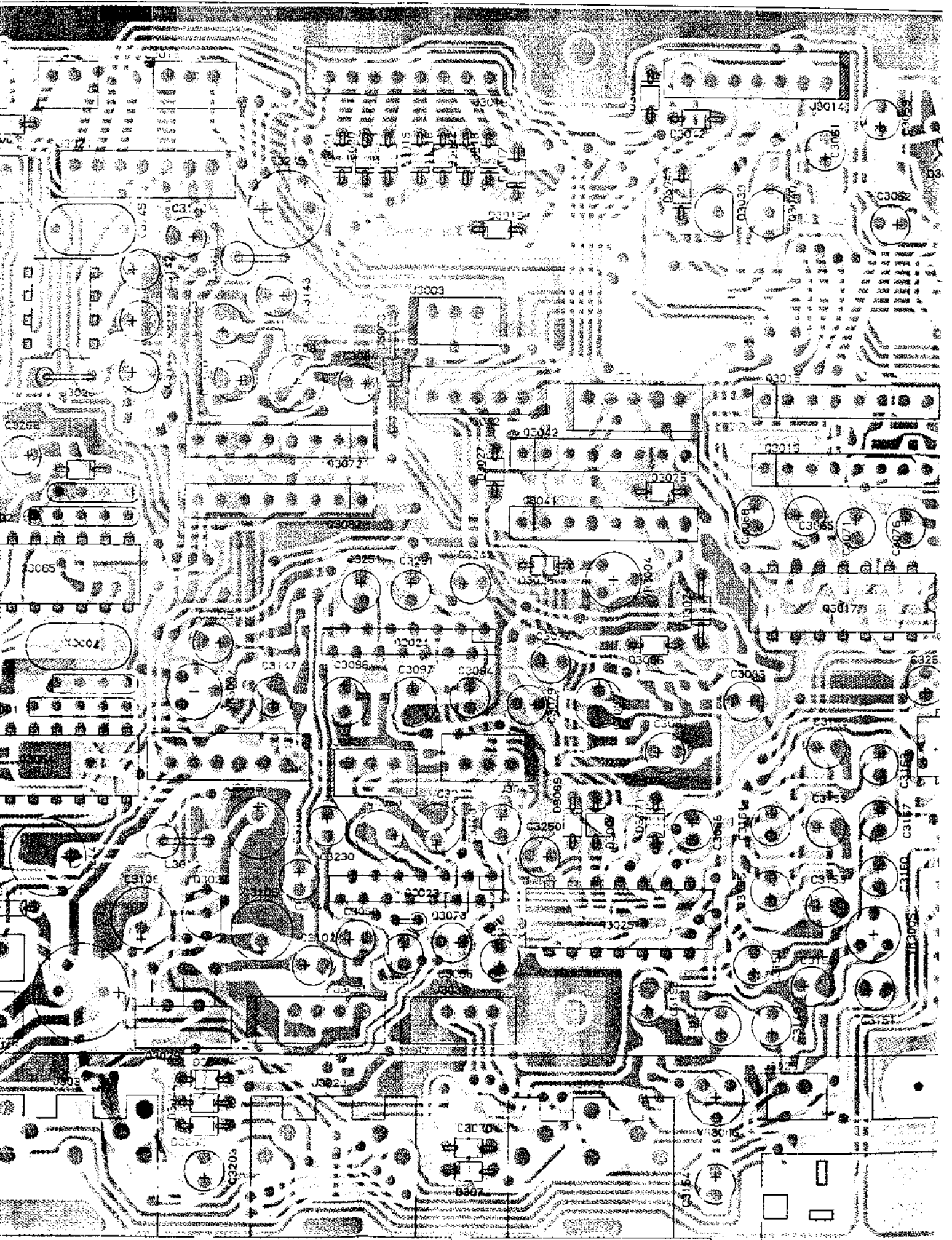

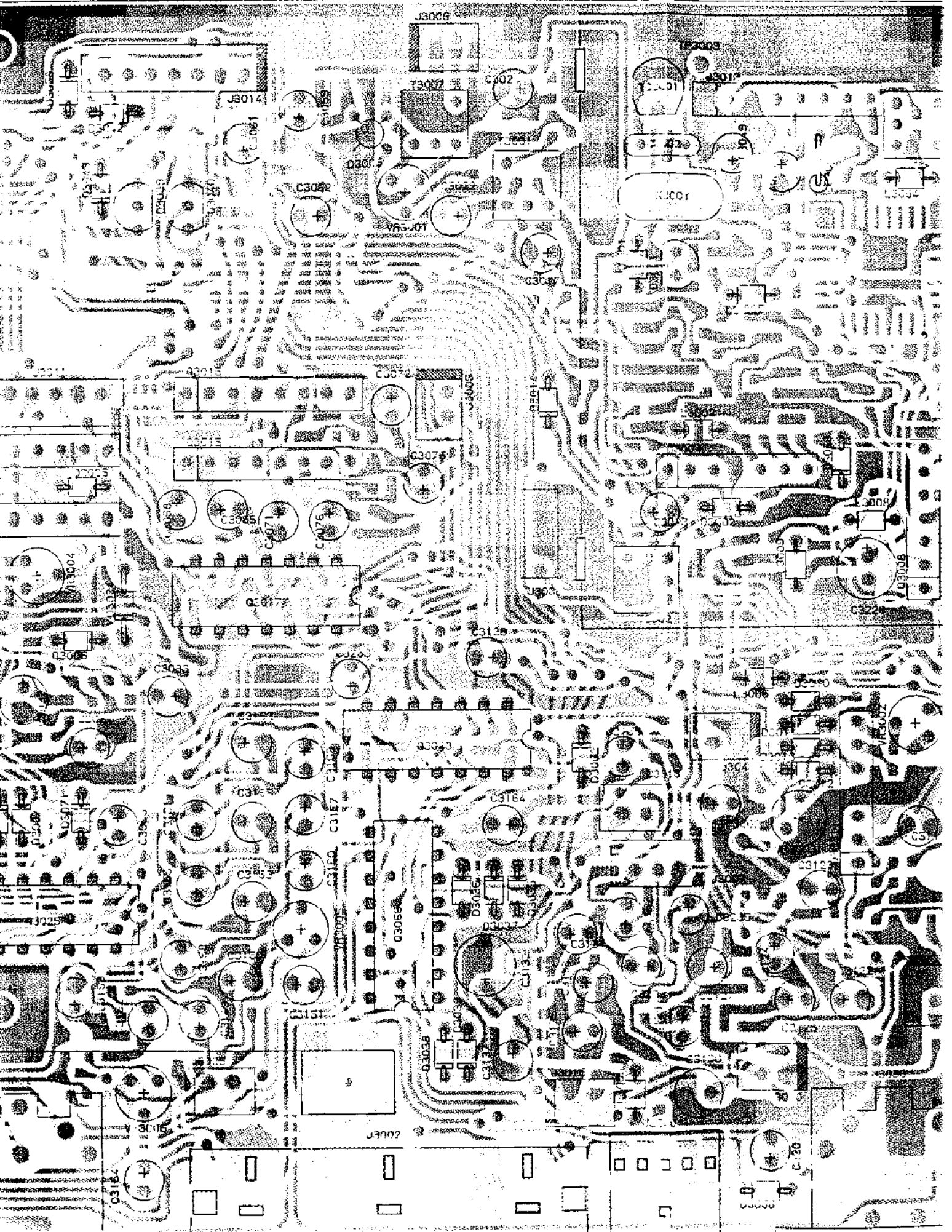

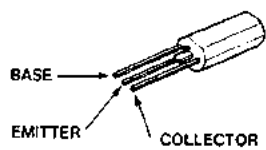
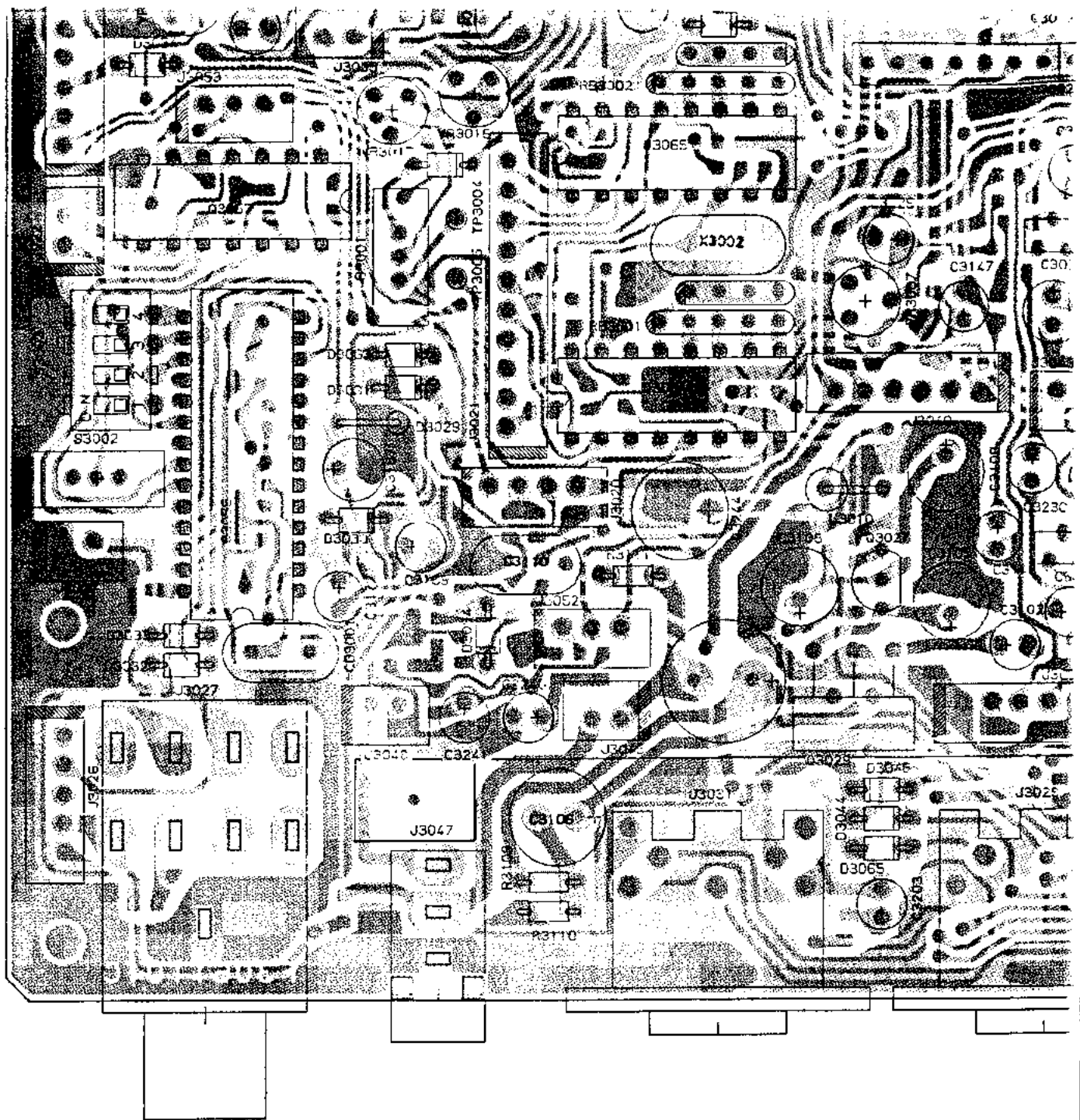

2SA1283D
(Q3039, Q3040)

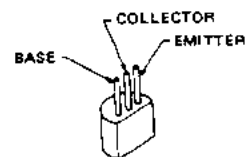

2SD6670
(Q3027)

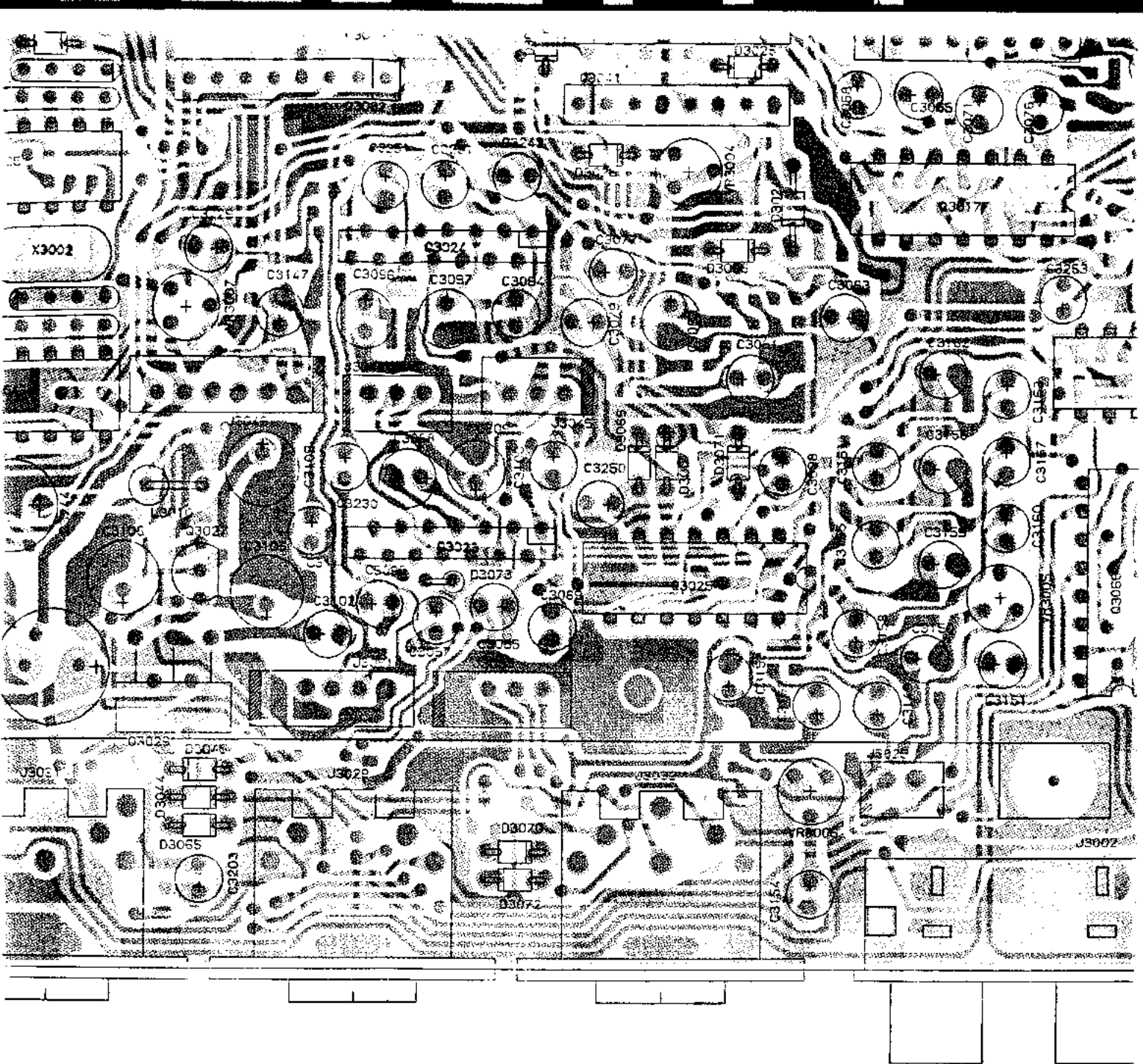

For Service Manuals Contact
MAURITRON TECHNICAL SERVICES
 8 Cherry Tree Rd. Chinnor
 Oxon OX9 4QY
 Tel:- 01844-351694 Fax:- 01844-352554
 Email:- enquiries@mauritron.co.uk

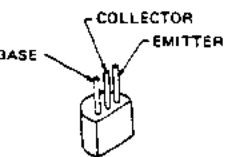

2SD667C
 (Q3027)

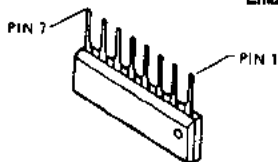

μPC1037H
 (Q3004, Q3008, Q3031)

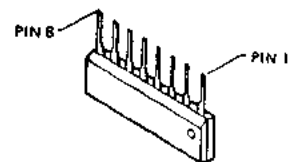

M5218L
 (Q3041, Q3042,
 Q3072, Q3074,
 Q3075, Q3076,
 Q3077, Q3082,
 Q3015, Q3016)

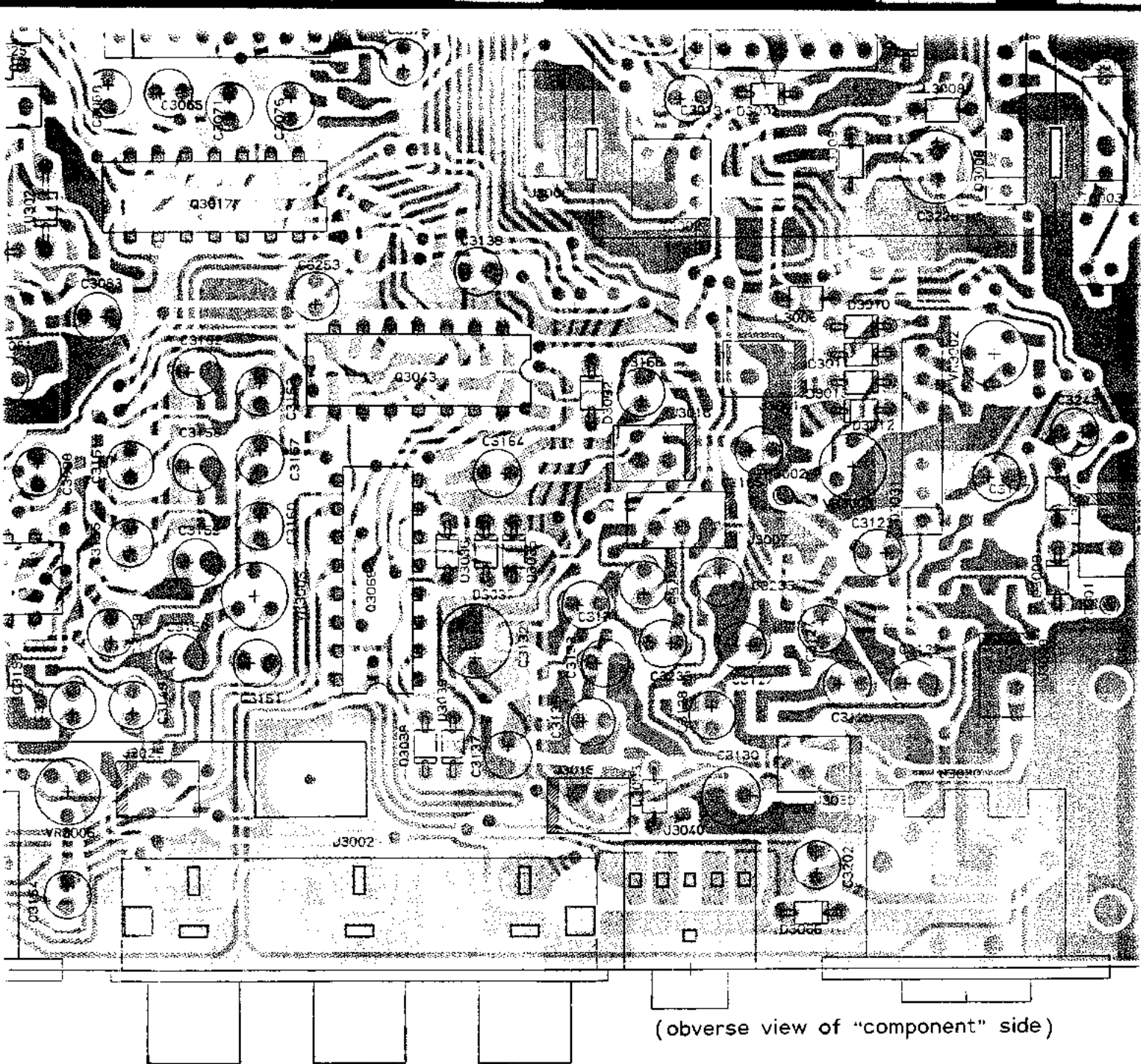

(obverse view of "component" side)

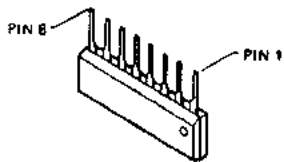

M5218L

- Q3041, Q3042,
- Q3072, Q3074,
- Q3075, Q3076,
- Q3077, Q3082,
- Q3015, Q3016

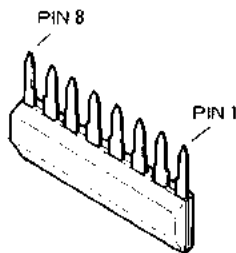

M54455L
(Q3013)

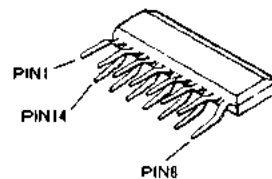

M51523AL
(Q3023, Q3024)

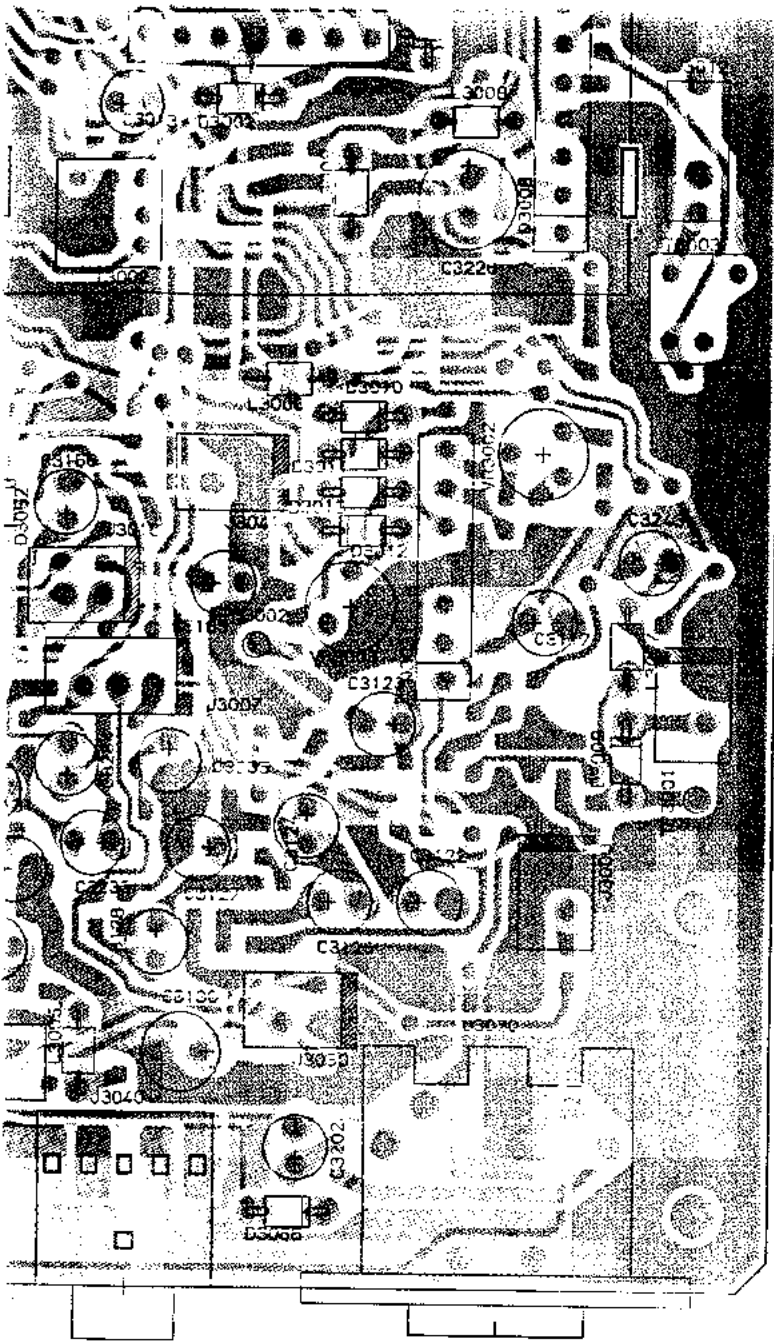

(obverse view of "component" side)



MC14028BCP
(Q3066)
MB88202H-634M
(Q3065)
MB88202H-635M
(Q3064)

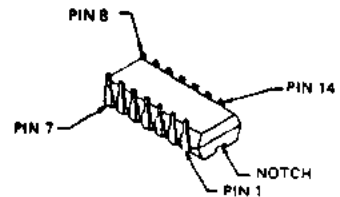

MC14011BCP
(Q3057)
μPD4066BC
(Q3017, Q3025, Q3043)

For Service Manuals Contact
MAURITRON TECHNICAL SERVICES
8 Cherry Tree Rd, Chinnor
Oxon OX9 4QY
Tel: 01844-351694 Fax: 01844-352554
Email: enquiries@mauritron.co.uk

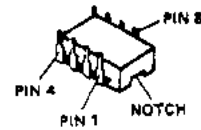

NE567N
(Q3045)

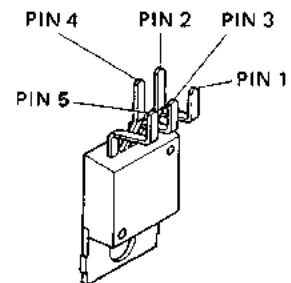

TDA2003
(Q3029)

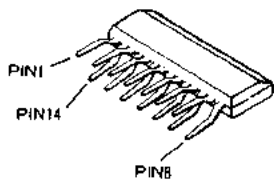

M51523AL
(Q3023, Q3024)

For Service Manuals Contact
MAURITRON TECHNICAL SERVICES
8 Cherry Tree Rd, Chinnor
Oxon OX9 4QY
Tel: 01844-351694 Fax: 01844-352554

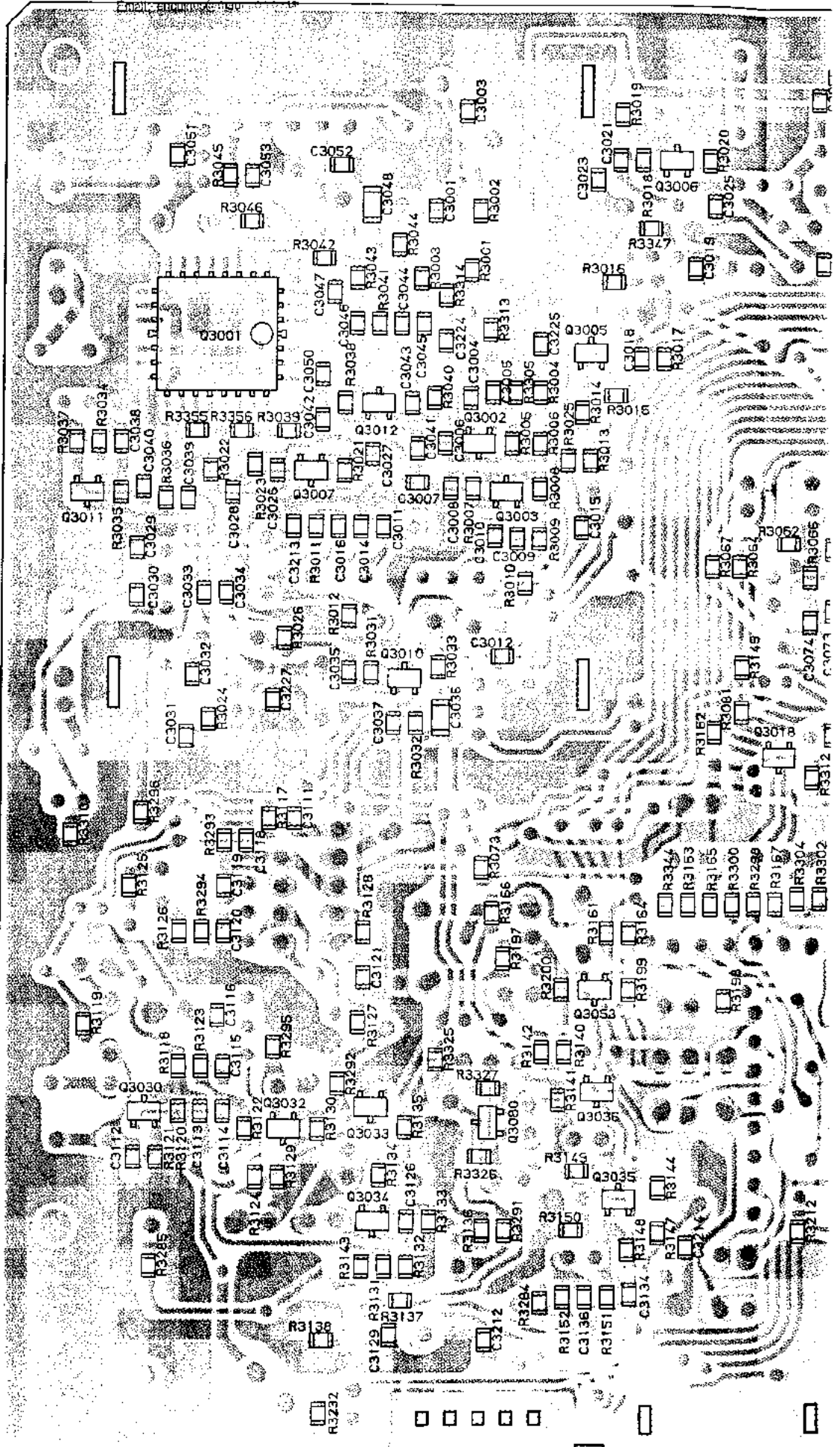

For Service Manuals Contact
MAURITRON TECHNICAL SERVICES
1 Chantry Way, Hemel Hempstead,
Oxon OX9 4QY
Tel: 01844-351634 Fax: 01844-352554
Email: enquiries@maurtron.co.uk

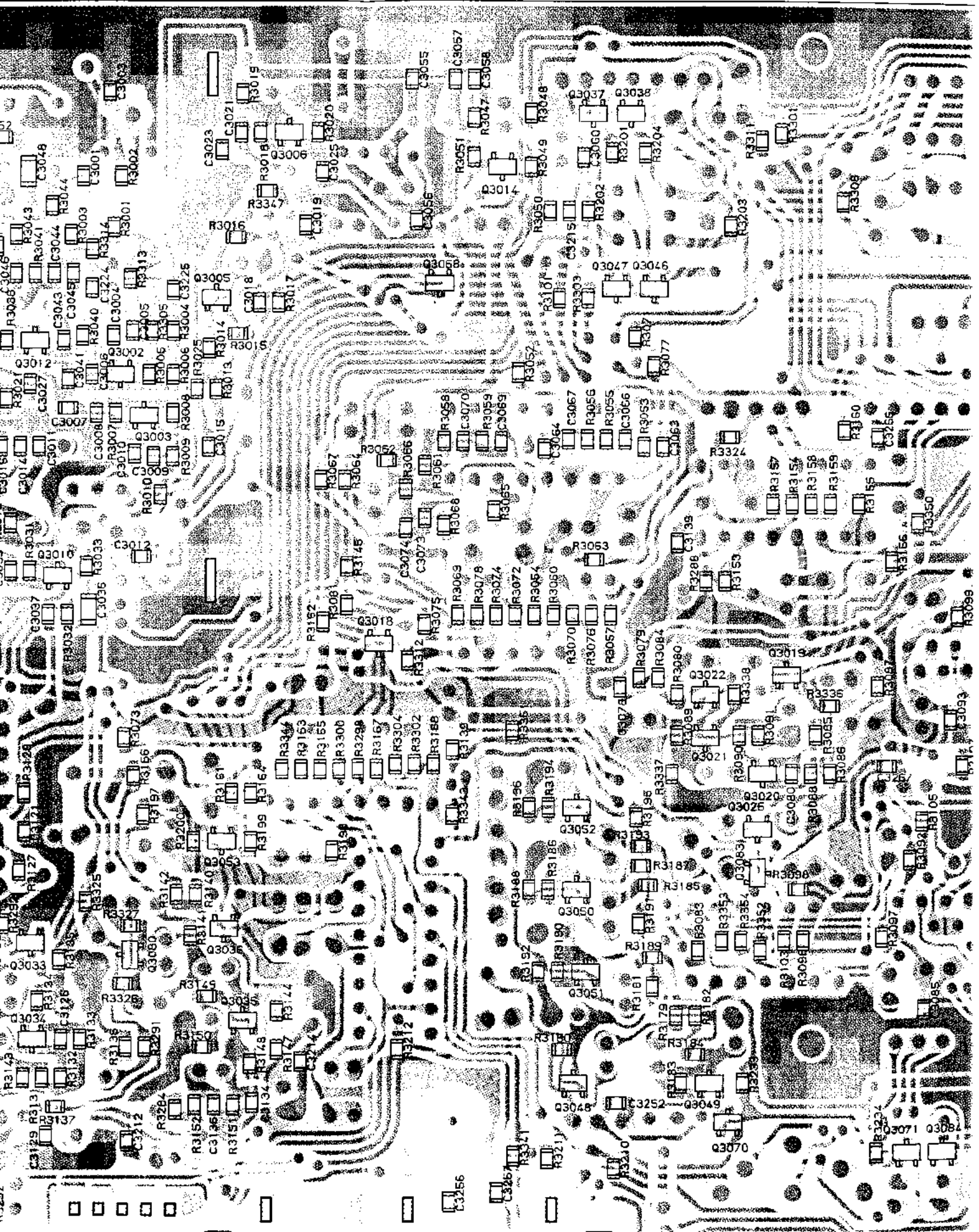

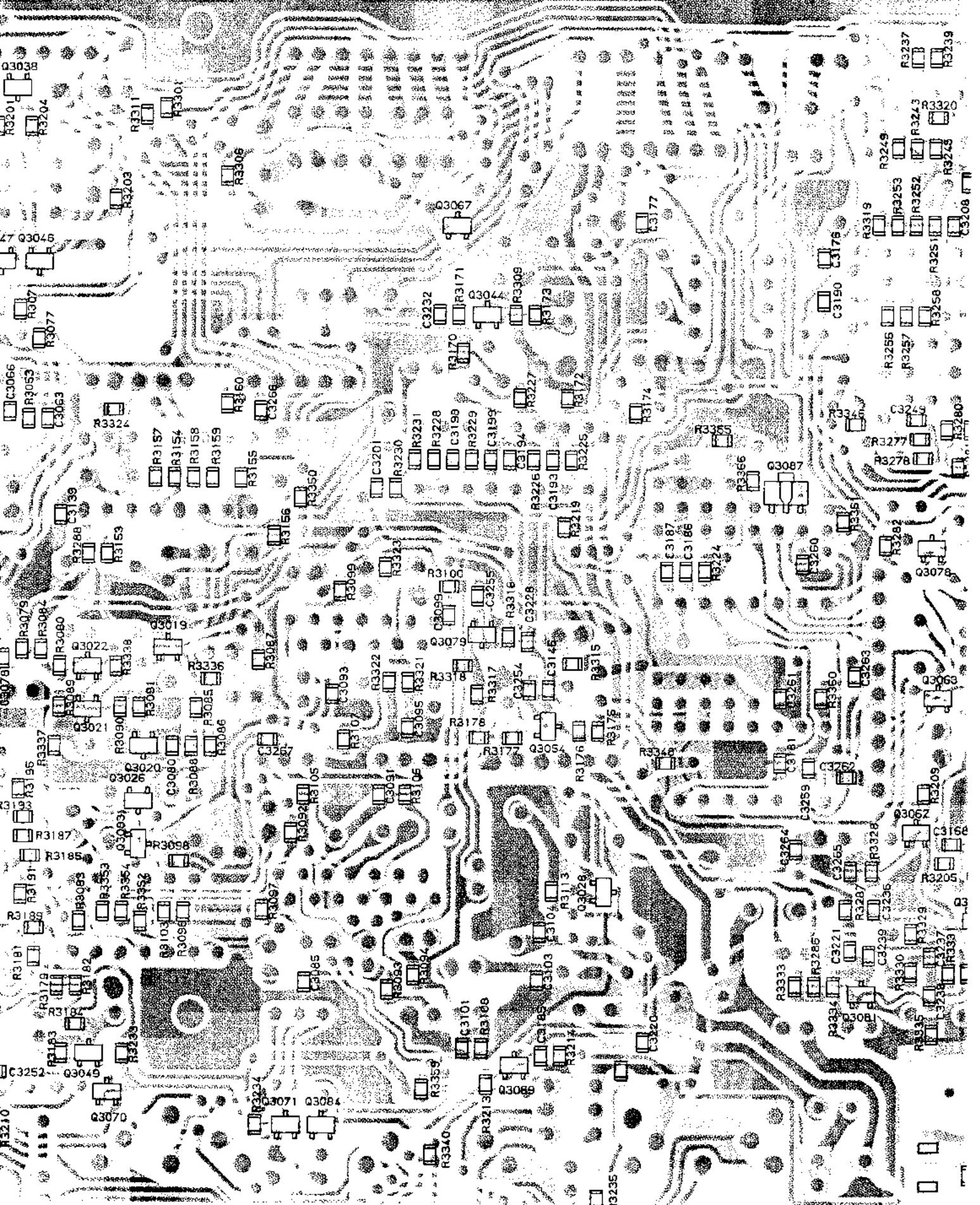

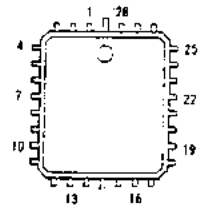
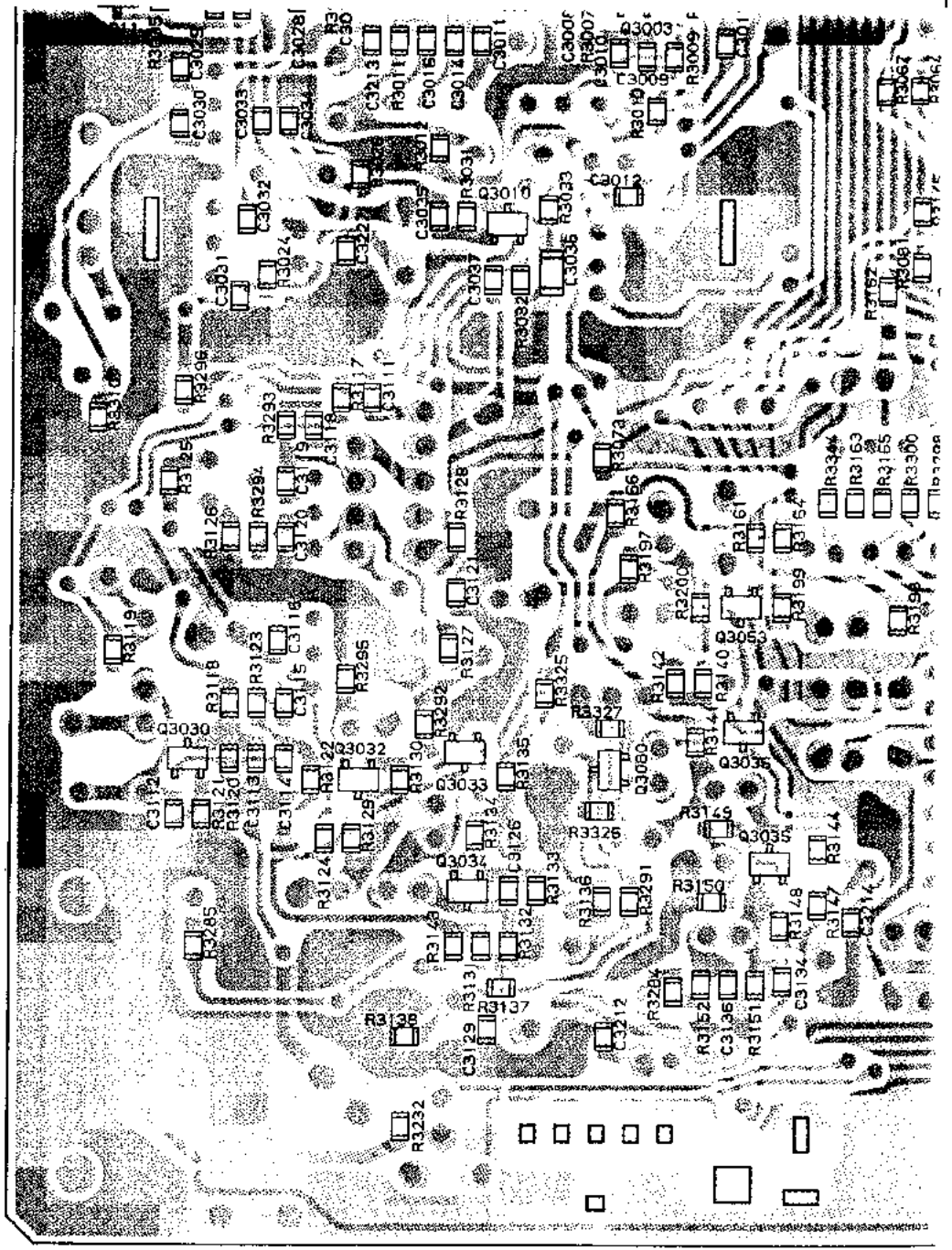

MC145163SL
(Q3001)

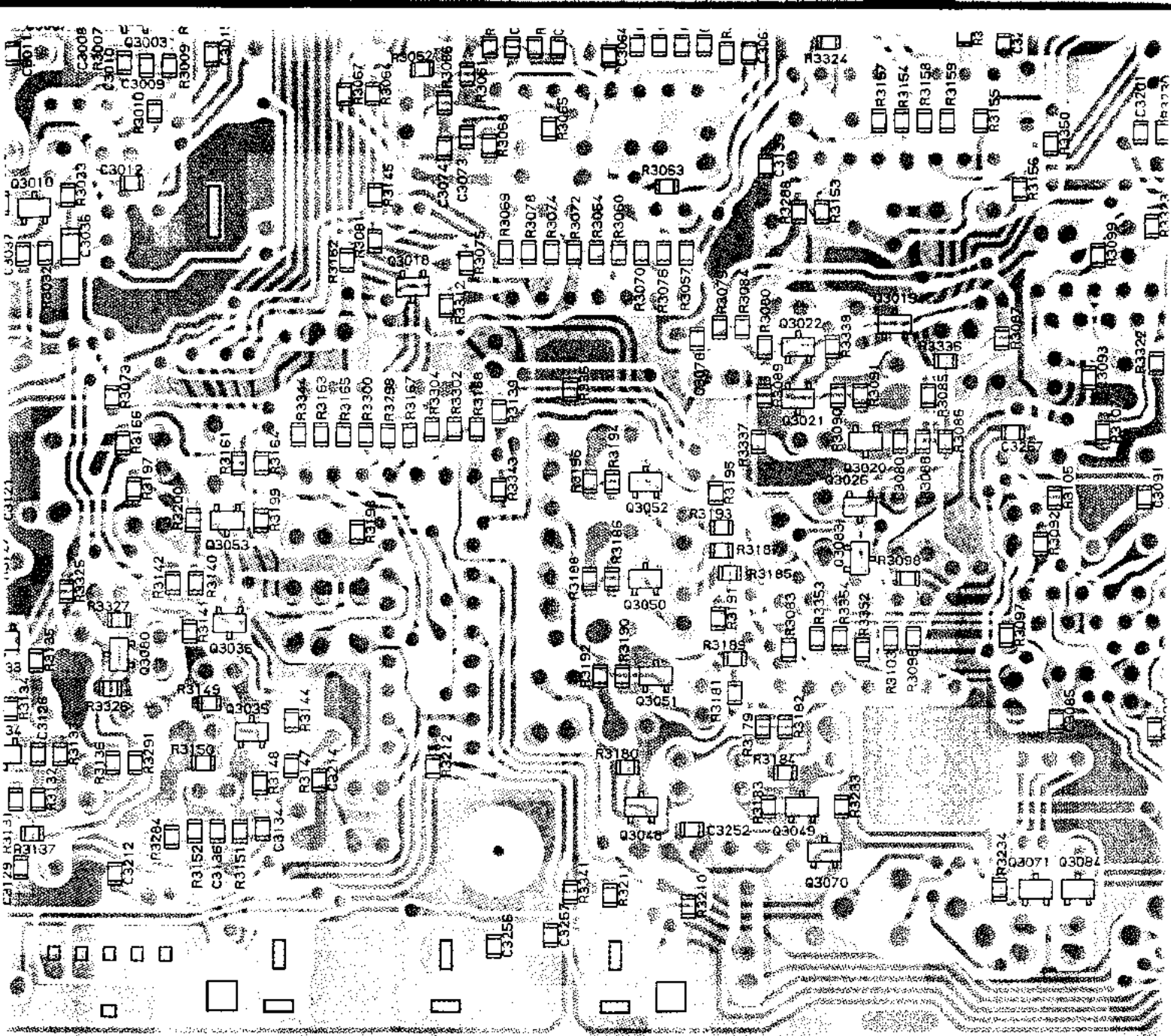

For Service Manuals Contact
MAURITRON TECHNICAL SERVICES
 8 Cherry Tree Rd, Chinnor
 Oxon OX9 4QY
 Tel: 01844-351694 Fax: 01844-352554
 Email: enquires@mauritron.co.uk

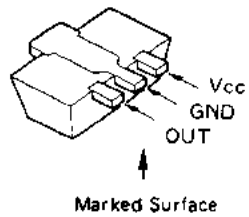
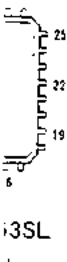

Marked Surface

M51943BML (A4)
(Q3087)

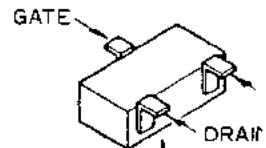

Marked Surface

2SK160 (K6)
(Q3019)

3SL

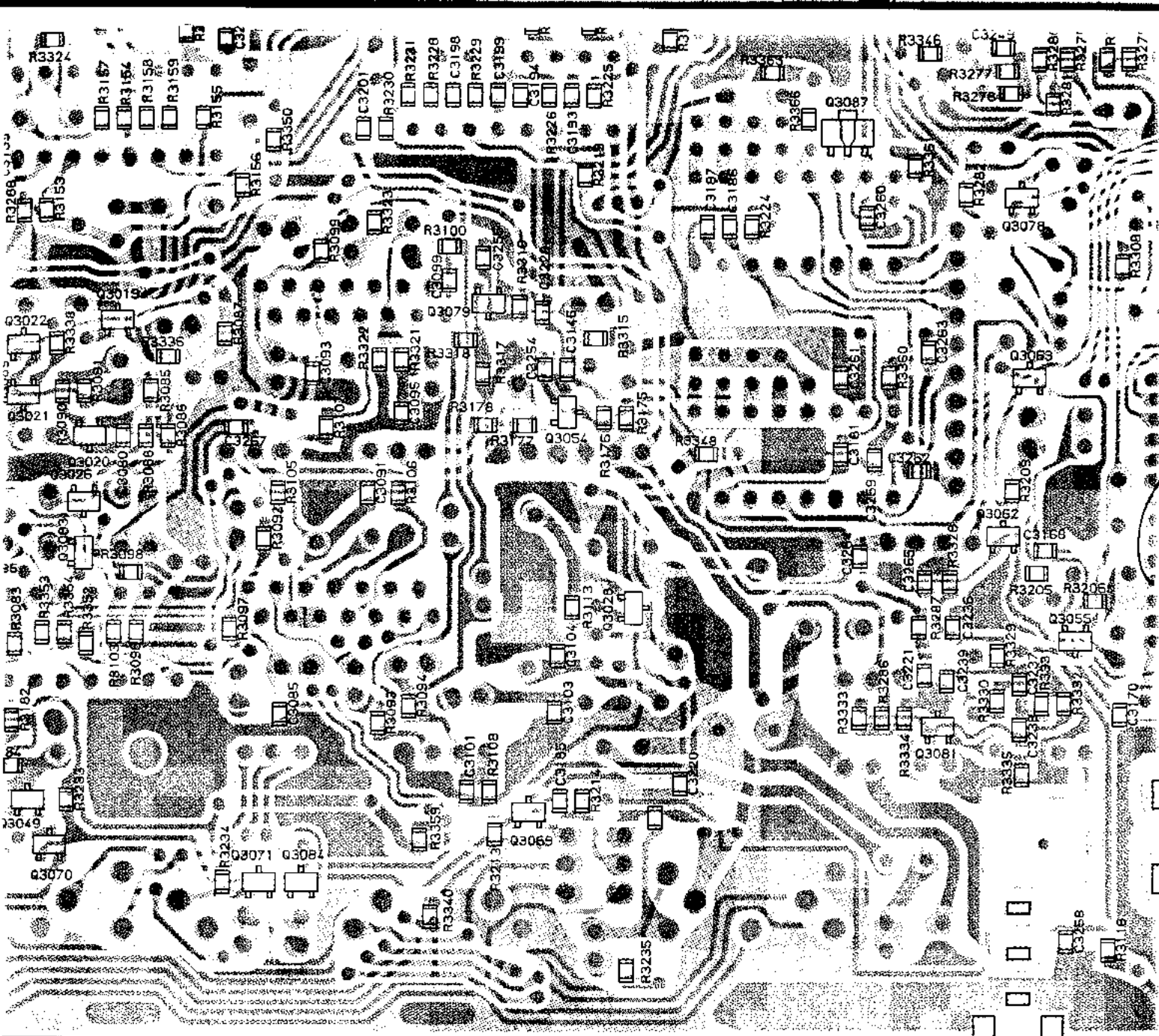

(obverse view of

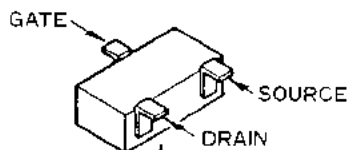

Marked Surface
2SK160(K6)
(Q3019)

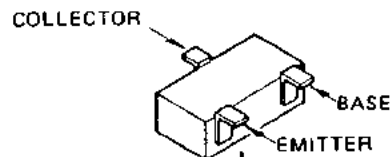

Marked Surface
2SC2712GR(LG)
(Q3002, Q3002, Q3012, Q3012, Q3035, Q3035, Q3054, Q3054)
FA1A4P(L34)
(Q3018, Q3021, Q3022, Q3026, Q3033, Q3037, Q3038, Q3046, Q3058, Q3060, Q3063, Q3068, Q3070, Q3071, Q3078, Q3078)
FA1F4N(L35)
(Q3067)
FN1A4P(M34)
(Q3047, Q3059, Q3061, Q3084)

For Service Manuals Contact
MAURITRON TECHNICAL SERVICES
 8 Cherry Tree Rd, Chinnor
 Oxon OX9 4QY
 Tel: 01844-351694 Fax: 01844-352554
 Email: enquiries@mairitron.co.uk

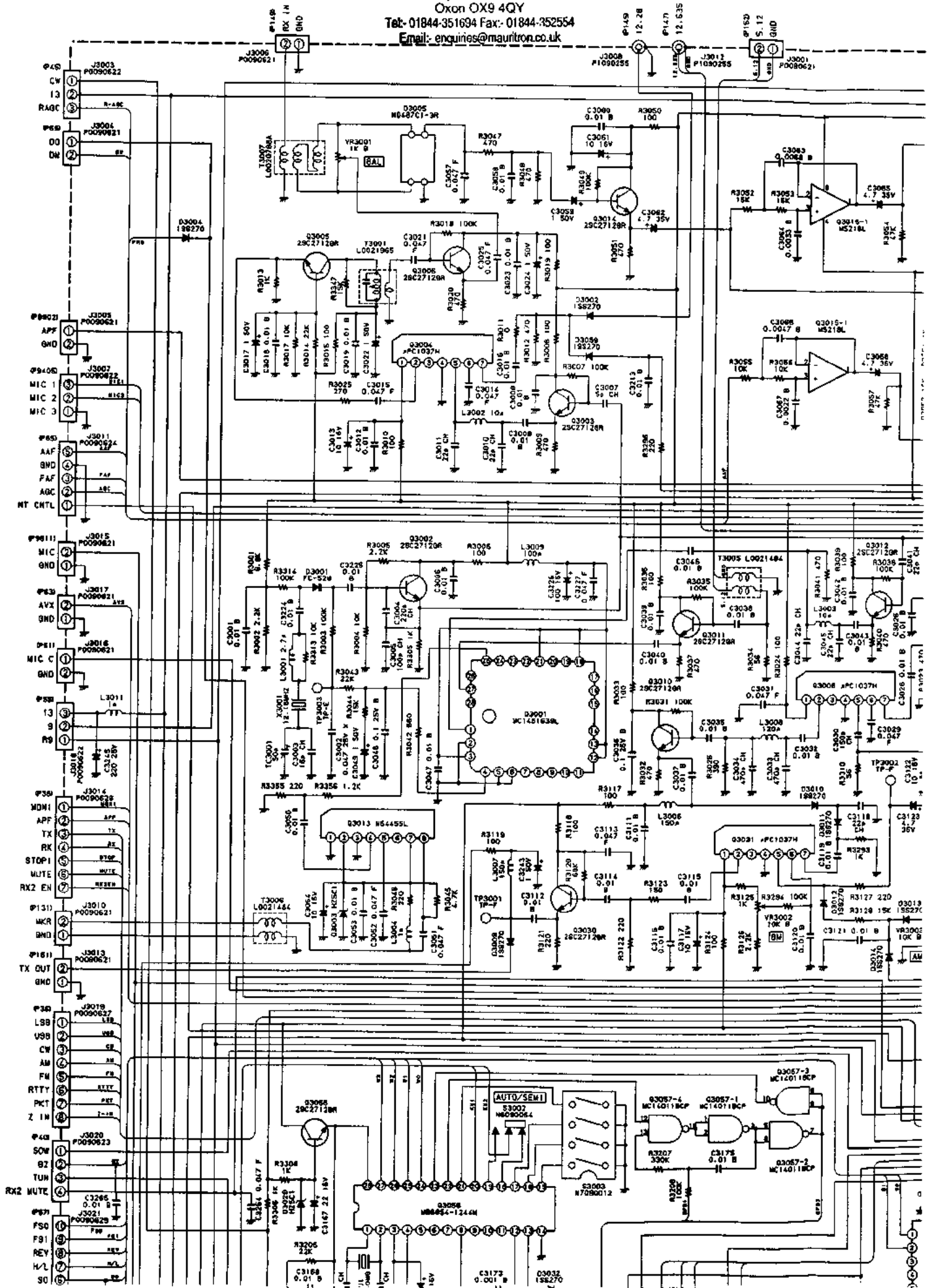

For Service Manuals Contact
MAURITRON TECHNICAL SERVICES
8 Cherry Tree Rd. Chinnor
Oxon OX9 4QY
Tel: 01844-351694 Fax: 01844-352554
Email: enquiries@mauritron.co.uk

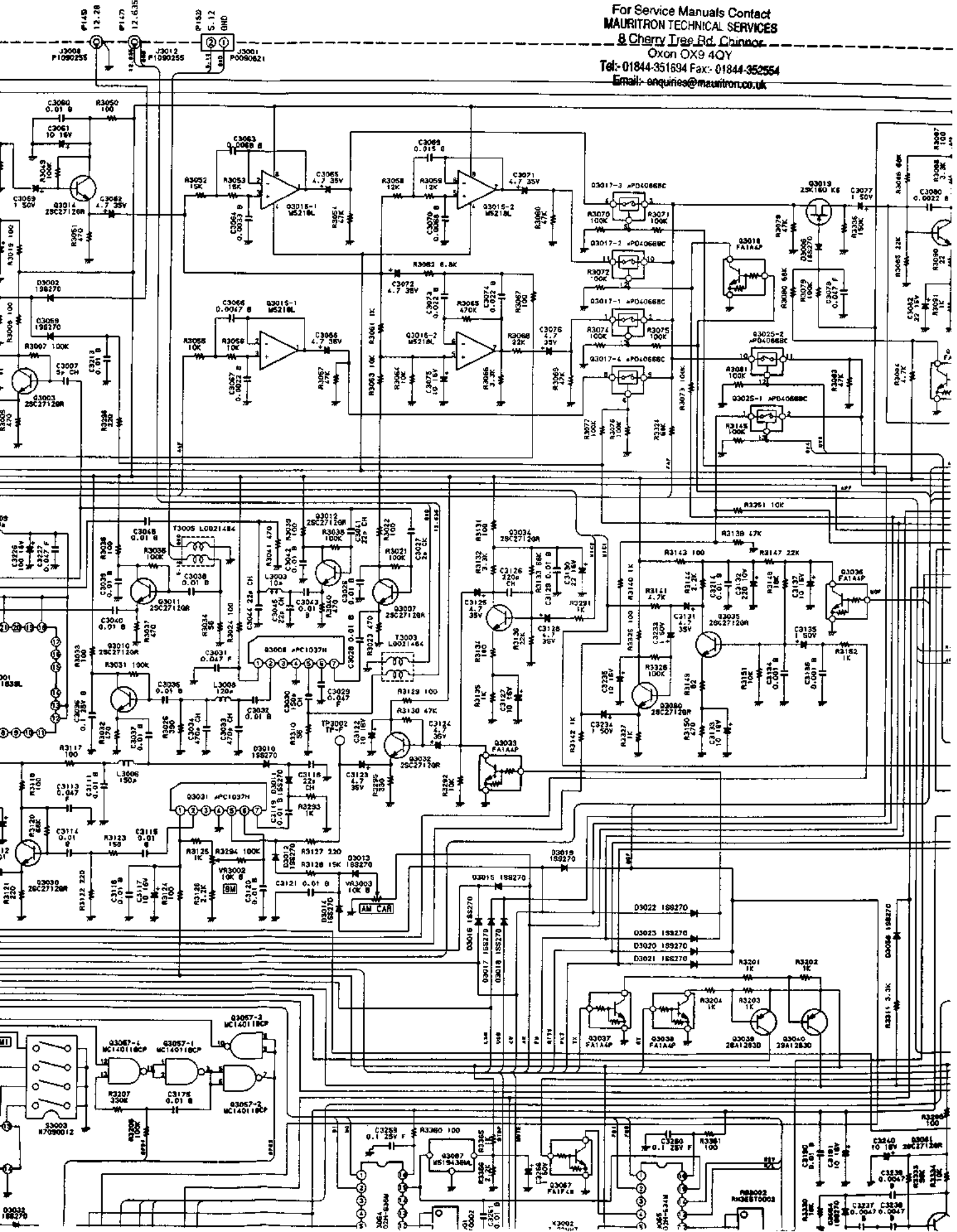

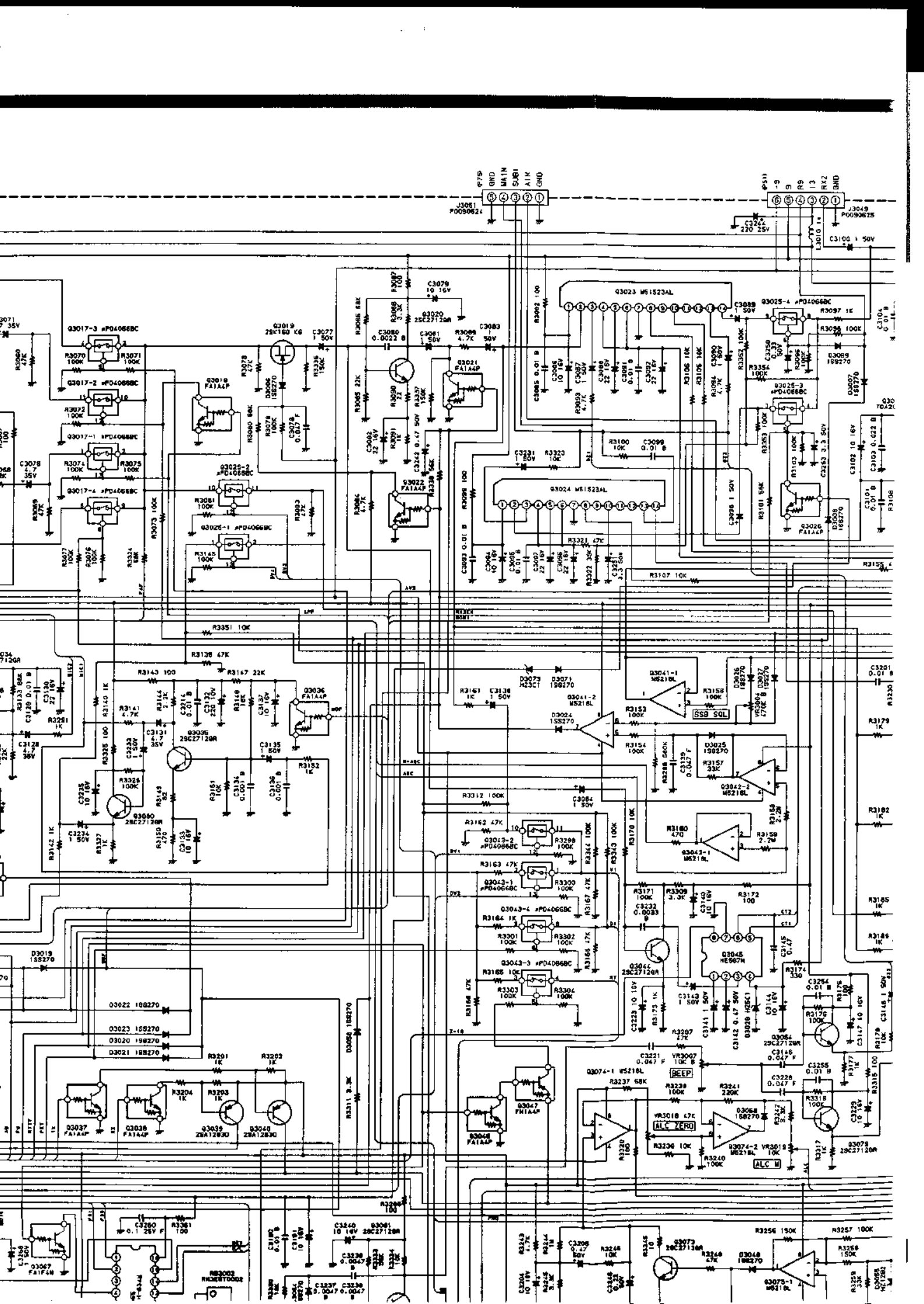

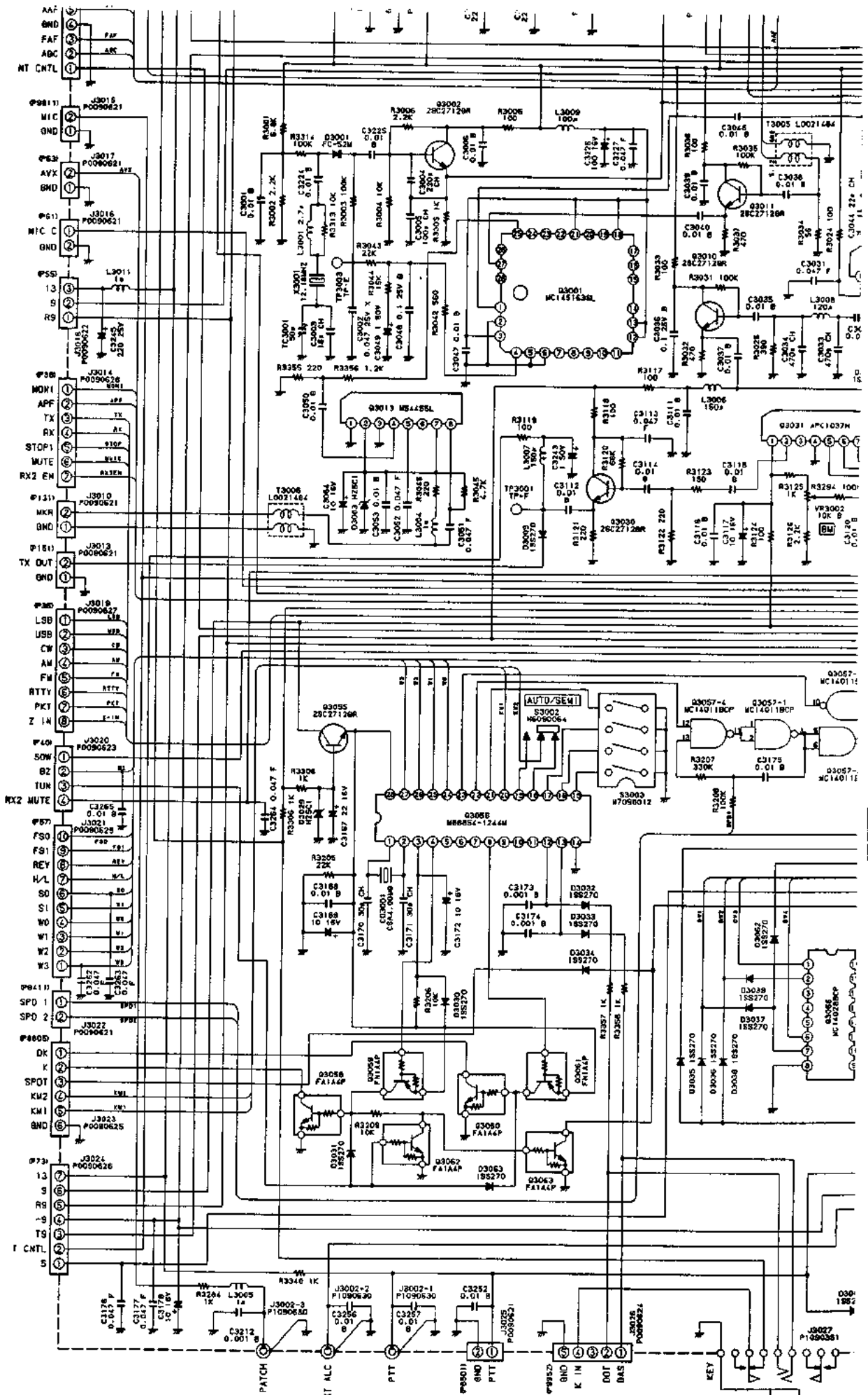

For Service Manuals Contact
MAURITRON TECHNICAL SERVICES
 8 Cherry Tree Rd, Chinnor
 Oxon OX9 4QY
 Tel: 01844-351694 Fax: 01844-352554
 Email: enquiries@mauritron.co.uk

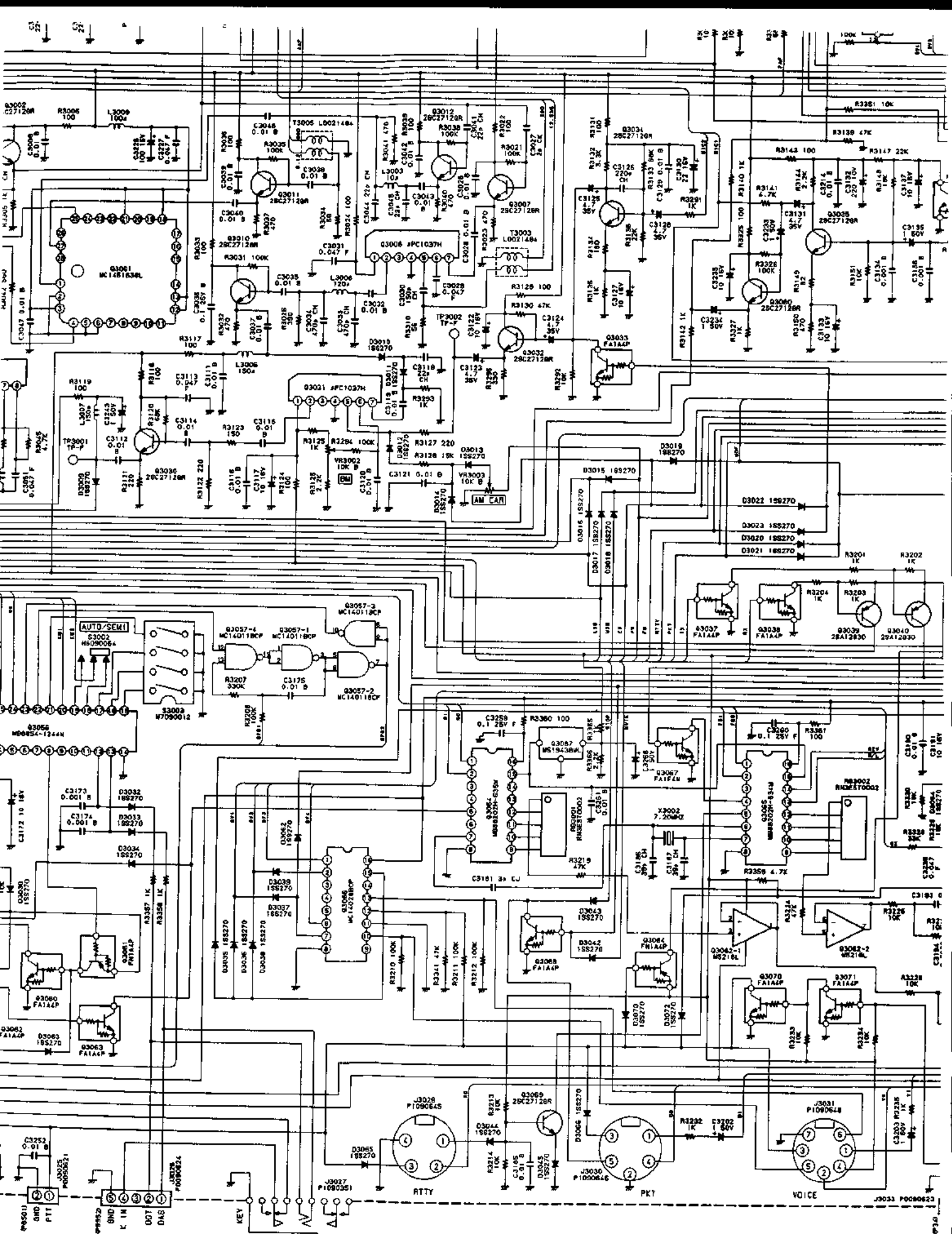

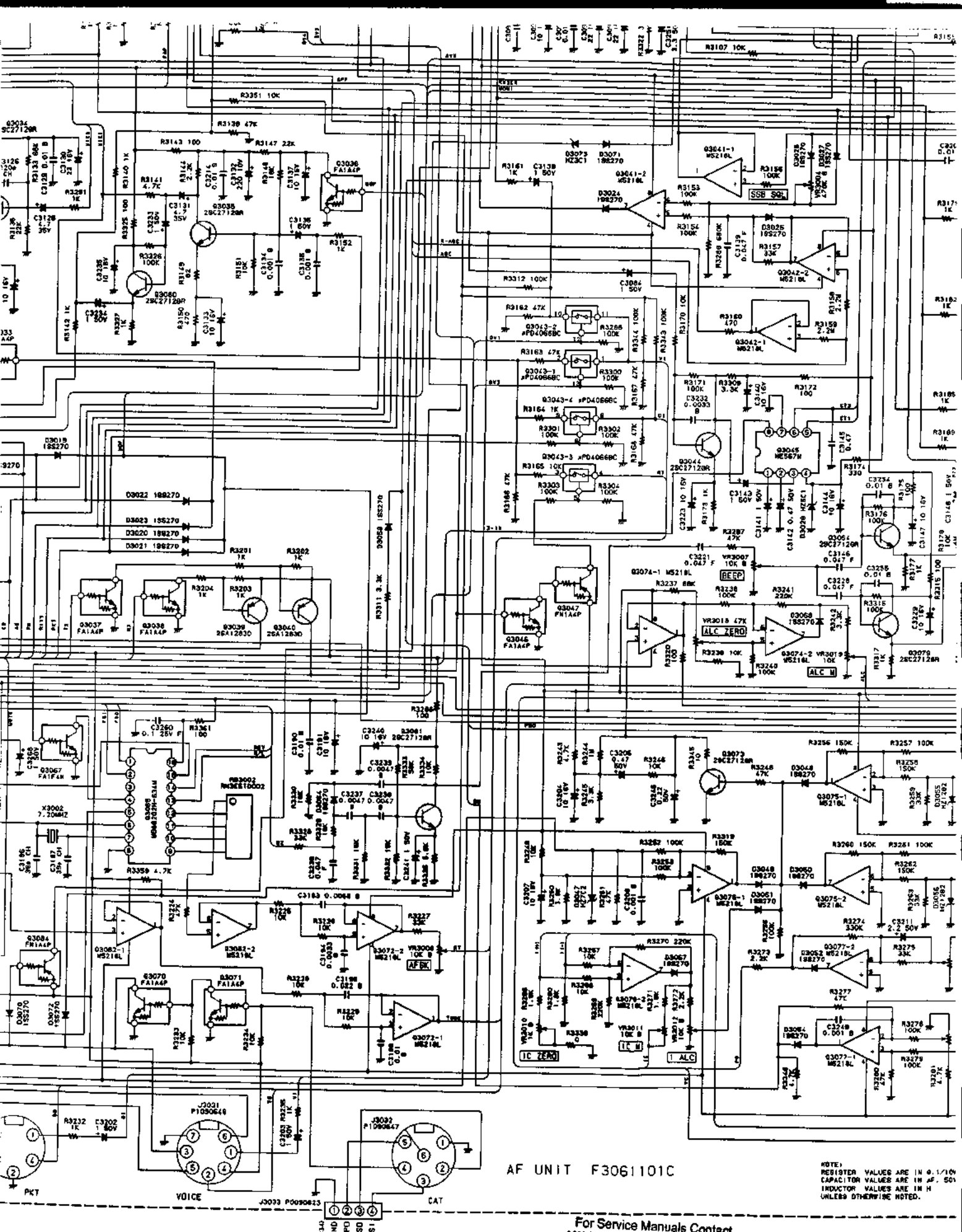

AF UNIT F3061101C

NOTE:
RESISTOR VALUES ARE IN Ω, 1/10Ω
CAPACITOR VALUES ARE IN μF, 50V
INDUCTOR VALUES ARE IN H
UNLESS OTHERWISE NOTED.

For Service Manuals Contact
MAURITRON TECHNICAL SERVICES
8 Cherry Tree Rd, Chinnor
Oxon, Ox4 5JW
Tel: 01844-351633 Fax: 01844-352354
Email: enquiries@mauritron.co.uk

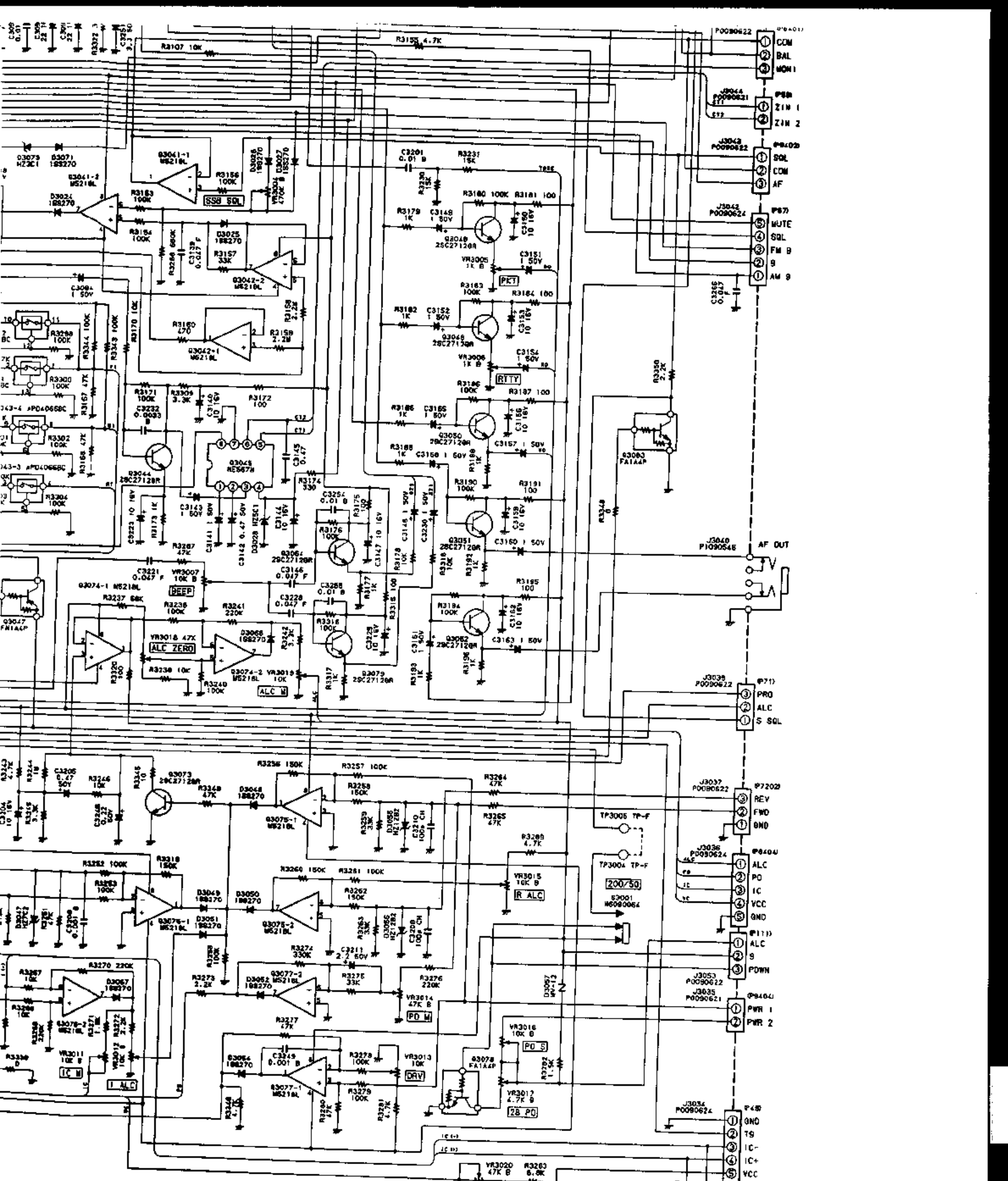

NOTE:
 RESISTOR VALUES ARE IN Ω , Ω /10K;
 CAPACITOR VALUES ARE IN μ F, SOV;
 INDUCTOR VALUES ARE IN H
 UNLESS OTHERWISE NOTED.

- J000622 P0090622 ① COM
- ② BAL
- ③ MON 1
- J0044 P0090621 ① PFM
- ② ZIN 1
- ③ ZIN 2
- J0042 P0090622 ① PFM 020
- ② SOL
- ③ COM
- ④ AF
- J0042 P0090624 ① PFM 7
- ② MUTE
- ③ SOL
- ④ FM B
- ⑤ S
- ⑥ AM 9
- J0040 P1000648 ① AF OUT
- J0039 P0090622 ① P71
- ② PRO
- ③ ALC
- ④ S SOL
- J0037 P0090622 ① P7202
- ② REV
- ③ FWD
- ④ GND
- J0036 P0090624 ① P8404
- ② ALC
- ③ PO
- ④ IC
- ⑤ VCC
- ⑥ GND
- ⑦ P111
- ⑧ ALC
- ⑨ S
- J0053 P0090612 ① P0W
- J0035 P0090621 ① P8404
- ② PWR 1
- ③ PWR 2
- J0034 P0090624 ① P45
- ② GND
- ③ TS
- ④ IC+
- ⑤ VCC

AF UNIT SCHEMATIC DIAGRAM

Local Unit Parts List

ADD	CODE NO	DESCRIPTION	DEVICE	TYP	VAL
** UNIT NAME : LOCAL-UNIT					
C 4001	K22170817	CHIP CAP.	GRM40B103M50PT	0.01uF	50V B
C 4002	K22170243	CHIP CAP.	GRM40CH221J50PT	220pF	50V CH
C 4003	K22170243	CHIP CAP.	GRM40CH221J50PT	220pF	50V CH
C 4004	K22170817	CHIP CAP.	GRM40B103M50PT	0.01uF	50V B
C 4005	K22170817	CHIP CAP.	GRM40B103M50PT	0.01uF	50V B
C 4006	K22170817	CHIP CAP.	GRM40B103M50PT	0.01uF	50V B
C 4007	K22170245	CHIP CAP.	GRM40CH271J50PT	270pF	50V CH
C 4008	K22170239	CHIP CAP.	GRM40CH151J50PT	150pF	50V CH
C 4009	K22170249	CHIP CAP.	GRM40CH391J50PT	390pF	50V CH
C 4010	K22170804	CHIP CAP.	GRM40B821M50PT	820pF	50V B
C 4011	K22170803	CHIP CAP.	GRM40B681M50PT	680pF	50V B
C 4012	K22170239	CHIP CAP.	GRM40CH151J50PT	150pF	50V CH
C 4013	K22170245	CHIP CAP.	GRM40CH271J50PT	270pF	50V CH
C 4014	K22170239	CHIP CAP.	GRM40CH151J50PT	150pF	50V CH
C 4015	K22170249	CHIP CAP.	GRM40CH391J50PT	390pF	50V CH
C 4016	K22170804	CHIP CAP.	GRM40B821M50PT	820pF	50V B
C 4017	K22170249	CHIP CAP.	GRM40CH391J50PT	390pF	50V CH
C 4018	K22170817	CHIP CAP.	GRM40B103M50PT	0.01uF	50V B
C 4019	K22170817	CHIP CAP.	GRM40B103M50PT	0.01uF	50V B
C 4020	K22170817	CHIP CAP.	GRM40B103M50PT	0.01uF	50V B
C 4021	K22170239	CHIP CAP.	GRM40CH151J50PT	150pF	50V CH
C 4022	K22170245	CHIP CAP.	GRM40CH271J50PT	270pF	50V CH
C 4023	K22170239	CHIP CAP.	GRM40CH151J50PT	150pF	50V CH
C 4024	K22170245	CHIP CAP.	GRM40CH271J50PT	270pF	50V CH
C 4025	K22170245	CHIP CAP.	GRM40CH271J50PT	270pF	50V CH
C 4026	K22170239	CHIP CAP.	GRM40CH151J50PT	150pF	50V CH
C 4027	K22170219	CHIP CAP.	GRM40CH220J50PT	22pF	50V CH
C 4028	K22170817	CHIP CAP.	GRM40B103M50PT	0.01uF	50V B
C 4029	K22170817	CHIP CAP.	GRM40B103M50PT	0.01uF	50V B
C 4030	K22170219	CHIP CAP.	GRM40CH220J50PT	22pF	50V CH
C 4031	K22170817	CHIP CAP.	GRM40B103M50PT	0.01uF	50V B
C 4032	K22170817	CHIP CAP.	GRM40B103M50PT	0.01uF	50V B
C 4033	K22170204	CHIP CAP.	GRM40CJ030C50PT	3pF	50V CJ
C 4034	K22170817	CHIP CAP.	GRM40B103M50PT	0.01uF	50V B
C 4035	K22170817	CHIP CAP.	GRM40B103M50PT	0.01uF	50V B
C 4036	K22170817	CHIP CAP.	GRM40B103M50PT	0.01uF	50V B
C 4037	K22141808	CHIP CAP.	GRM42-6B473M25PT	0.047uF	25V B
C 4038	K22170241	CHIP CAP.	GRM40CH181J50PT	180pF	50V CH
C 4039	K22170241	CHIP CAP.	GRM40CH181J50PT	180pF	50V CH
C 4040	K22170817	CHIP CAP.	GRM40B103M50PT	0.01uF	50V B
C 4041	K22170817	CHIP CAP.	GRM40B103M50PT	0.01uF	50V B
C 4042	K22171008	CHIP CAP.	GRM40F473Z50PT	0.047uF	50V F
C 4043	K46120004	AL. ELECTRO. CAP.	16V100M4X7TR2	10uF	16V B
C 4044	K22170817	CHIP CAP.	GRM40B103M50PT	0.01uF	50V B
C 4045	K46120006	AL. ELECTRO. CAP.	16V470M6X7TR2	47uF	16V B
C 4046	K70167334	TANTALUM CAP.	DN1VR33M1S	0.33uF	35V B
C 4047	K22140810	CHIP CAP.	GRM40B333M25PT	0.033uF	25V B
C 4048	K22170211	CHIP CAP.	GRM40CH100D50PT	10pF	50V CH
C 4049	K22170327	CHIP CAP.	GRM40UJ470J50PT	47pF	50V UJ
C 4050	K22170327	CHIP CAP.	GRM40UJ470J50PT	47pF	50V UJ
C 4051	K22170817	CHIP CAP.	GRM40B103M50PT	0.01uF	50V B
C 4052	K22170817	CHIP CAP.	GRM40B103M50PT	0.01uF	50V B
C 4053	K40129028	AL. ELECTRO. CAP.	RC2-16V470M(6X7)	47uF	16V B
C 4054	K22170202	CHIP CAP.	GRM40CK010C50PT	1pF	50V CK
C 4055	K22170817	CHIP CAP.	GRM40B103M50PT	0.01uF	50V B
C 4056	K22170805	CHIP CAP.	GRM40B102M50PT	0.001uF	50V B
C 4057	K22170805	CHIP CAP.	GRM40B102M50PT	0.001uF	50V B
C 4058	K22170805	CHIP CAP.	GRM40B102M50PT	0.001uF	50V B
C 4059	K22170805	CHIP CAP.	GRM40B102M50PT	0.001uF	50V B
C 4060	K22170805	CHIP CAP.	GRM40B102M50PT	0.001uF	50V B
C 4061	K22170805	CHIP CAP.	GRM40B102M50PT	0.001uF	50V B
C 4062	K22170205	CHIP CAP.	GRM40CH040C50PT	4pF	50V CH
C 4063	K70167105	TANTALUM CAP.	DN1V010M1S	1uF	35V B
C 4064	K22170817	CHIP CAP.	GRM40B103M50PT	0.01uF	50V B
C 4065	K70167105	TANTALUM CAP.	DN1V010M1S	1uF	35V B
C 4066	K22170805	CHIP CAP.	GRM40B102M50PT	0.001uF	50V B
C 4067	K22170327	CHIP CAP.	GRM40UJ470J50PT	47pF	50V UJ
C 4068	K22170327	CHIP CAP.	GRM40UJ470J50PT	47pF	50V UJ
C 4069	K22170817	CHIP CAP.	GRM40B103M50PT	0.01uF	50V B
C 4070	K22170817	CHIP CAP.	GRM40B103M50PT	0.01uF	50V B
C 4071	K46120006	AL. ELECTRO. CAP.	16V470M6X7TR2	47uF	16V B
C 4072	K22170203	CHIP CAP.	GRM40CK020C50PT	2pF	50V CK
C 4073	K22170817	CHIP CAP.	GRM40B103M50PT	0.01uF	50V B
C 4074	K22170203	CHIP CAP.	GRM40CK020C50PT	2pF	50V CK
C 4075	K22170211	CHIP CAP.	GRM40CH100D50PT	10pF	50V CH
C 4076	K22170211	CHIP CAP.	GRM40CH100D50PT	10pF	50V CH
C 4077	K22170203	CHIP CAP.	GRM40CK020C50PT	2pF	50V CK
C 4078	K22170817	CHIP CAP.	GRM40B103M50PT	0.01uF	50V B
C 4079	K22170817	CHIP CAP.	GRM40B103M50PT	0.01uF	50V B
C 4080	K22170817	CHIP CAP.	GRM40B103M50PT	0.01uF	50V B
C 4081	K22170817	CHIP CAP.	GRM40B103M50PT	0.01uF	50V B
C 4082	K22170221	CHIP CAP.	GRM40CH270J50PT	27pF	50V CH

Local Unit Parts List

ADD	CODE NO	DESCRIPTION	DEVICE			TYP	VAL
C 4083	K22170221	CHIP CAP.	GRM40CH270J50PT	27pF	50V	CH	
C 4084	K22170211	CHIP CAP.	GRM40CH100D50PT	10pF	50V	CH	
C 4085	K22170817	CHIP CAP.	GRM40B103M50PT	0.01uF	50V	B	
C 4086	K22170817	CHIP CAP.	GRM40B103M50PT	0.01uF	50V	B	
C 4087	K22170817	CHIP CAP.	GRM40B103M50PT	0.01uF	50V	B	
C 4089	K22170327	CHIP CAP.	GRM40UJ470J50PT	47pF	50V	UJ	
C 4090	K22170327	CHIP CAP.	GRM40UJ470J50PT	47pF	50V	UJ	
C 4091	K46120006	AL. ELECTRO. CAP.	16V470M6X7TR2	47uF	16V		
C 4092	K22170817	CHIP CAP.	GRM40B103M50PT	0.01uF	50V	B	
C 4093	K22170817	CHIP CAP.	GRM40B103M50PT	0.01uF	50V	B	
C 4094	K22170203	CHIP CAP.	GRM40CK020C50PT	2pF	50V	CK	
C 4095	K22170817	CHIP CAP.	GRM40B103M50PT	0.01uF	50V	B	
C 4096	K22170817	CHIP CAP.	GRM40B103M50PT	0.01uF	50V	B	
C 4097	K22170213	CHIP CAP.	GRM40CH120J50PT	12pF	50V	CH	
C 4098	K22170213	CHIP CAP.	GRM40CH120J50PT	12pF	50V	CH	
C 4099	K22170805	CHIP CAP.	GRM40B102M50PT	0.001uF	50V	B	
C 4100	K22170817	CHIP CAP.	GRM40B103M50PT	0.01uF	50V	B	
C 4101	K22170205	CHIP CAP.	GRM40CH040C50PT	4pF	50V	CH	
C 4102	K22170817	CHIP CAP.	GRM40B103M50PT	0.01uF	50V	B	
C 4103	K46120004	AL. ELECTRO. CAP.	16V100M4X7TR2	10uF	16V		
C 4104	K22170821	CHIP CAP.	GRM40B223M50PT	0.022uF	50V	B	
C 4105	K46120005	AL. ELECTRO. CAP.	16V220M5X7TR2	22uF	16V		
C 4106	K22171008	CHIP CAP.	GRM40F473Z50PT	0.047uF	50V	F	
C 4107	K22170809	CHIP CAP.	GRM40B222M50PT	0.0022uF	50V	B	
C 4108	K22170809	CHIP CAP.	GRM40B222M50PT	0.0022uF	50V	B	
C 4109	K22171008	CHIP CAP.	GRM40F473Z50PT	0.047uF	50V	F	
C 4110	K22141809	CHIP CAP.	GRM42-6B104M25PT	0.1uF	25V	B	
C 4111	K46120007	AL. ELECTRO. CAP.	16V101M6X7TR2	100uF	16V		
C 4112	K22141808	CHIP CAP.	GRM42-6B473M25PT	0.047uF	25V	B	
C 4113	K22170817	CHIP CAP.	GRM40B103M50PT	0.01uF	50V	B	
C 4114	K22171008	CHIP CAP.	GRM40F473Z50PT	0.047uF	50V	F	
C 4115	K22170821	CHIP CAP.	GRM40B223M50PT	0.022uF	50V	B	
C 4116	K22170807	CHIP CAP.	GRM40B152M50PT	0.0015	50V	B	
C 4117	K22170807	CHIP CAP.	GRM40B152M50PT	0.0015	50V	B	
C 4118	K22170225	CHIP CAP.	GRM40CH390J50PT	39pF	50V	CH	
C 4119	K22170241	CHIP CAP.	GRM40CH181J50PT	180pF	50V	CH	
C 4120	K22170241	CHIP CAP.	GRM40CH181J50PT	180pF	50V	CH	
C 4121	K46120006	AL. ELECTRO. CAP.	16V470M6X7TR2	47uF	16V		
C 4122	K22170817	CHIP CAP.	GRM40B103M50PT	0.01uF	50V	B	
C 4123	K22170202	CHIP CAP.	GRM40CK010C50PT	1pF	50V	CK	
C 4124	K22170817	CHIP CAP.	GRM40B103M50PT	0.01uF	50V	B	
C 4126	K22170219	CHIP CAP.	GRM40CH220J50PT	22pF	50V	CH	
C 4127	K22170225	CHIP CAP.	GRM40CH390J50PT	39pF	50V	CH	
C 4128	K22170219	CHIP CAP.	GRM40CH220J50PT	22pF	50V	CH	
C 4129	K22170821	CHIP CAP.	GRM40B223M50PT	0.022uF	50V	B	
C 4130	K46120006	AL. ELECTRO. CAP.	16V470M6X7TR2	47uF	16V		
C 4131	K22170821	CHIP CAP.	GRM40B223M50PT	0.022uF	50V	B	
C 4132	K46120006	AL. ELECTRO. CAP.	16V470M6X7TR2	47uF	16V		
C 4133	K22170821	CHIP CAP.	GRM40B223M50PT	0.022uF	50V	B	
C 4134	K22170821	CHIP CAP.	GRM40B223M50PT	0.022uF	50V	B	
C 4135	K22170211	CHIP CAP.	GRM40CH100D50PT	10pF	50V	CH	
C 4136	K22170817	CHIP CAP.	GRM40B103M50PT	0.01uF	50V	B	
C 4137	K22170817	CHIP CAP.	GRM40B103M50PT	0.01uF	50V	B	
C 4138	K22170235	CHIP CAP.	GRM40CH101J50PT	100pF	50V	CH	
C 4139	K22170235	CHIP CAP.	GRM40CH101J50PT	100pF	50V	CH	
C 4140	K22170817	CHIP CAP.	GRM40B103M50PT	0.01uF	50V	B	
C 4141	K22171008	CHIP CAP.	GRM40F473Z50PT	0.047uF	50V	F	
C 4142	K22171008	CHIP CAP.	GRM40F473Z50PT	0.047uF	50V	F	
C 4143	K46120007	AL. ELECTRO. CAP.	16V101M6X7TR2	100uF	16V		
C 4144	K22170235	CHIP CAP.	GRM40CH101J50PT	100pF	50V	CH	
C 4145	K22170235	CHIP CAP.	GRM40CH101J50PT	100pF	50V	CH	
C 4146	K22170817	CHIP CAP.	GRM40B103M50PT	0.01uF	50V	B	
C 4147	K22171008	CHIP CAP.	GRM40F473Z50PT	0.047uF	50V	F	
C 4148	K22171008	CHIP CAP.	GRM40F473Z50PT	0.047uF	50V	F	
C 4149	K46120007	AL. ELECTRO. CAP.	16V101M6X7TR2	100uF	16V		
C 4150	K22170809	CHIP CAP.	GRM40B222M50PT	0.0022uF	50V	B	
C 4151	K22170809	CHIP CAP.	GRM40B222M50PT	0.0022uF	50V	B	
C 4154	K22141808	CHIP CAP.	GRM42-6B473M25PT	0.047uF	25V	B	
C 4155	K22170817	CHIP CAP.	GRM40B103M50PT	0.01uF	50V	B	
C 4156	K22171008	CHIP CAP.	GRM40F473Z50PT	0.047uF	50V	F	
C 4157	K22170821	CHIP CAP.	GRM40B223M50PT	0.022uF	50V	B	
C 4158	K46120006	AL. ELECTRO. CAP.	16V470M6X7TR2	47uF	16V		
C 4159	K22171008	CHIP CAP.	GRM40F473Z50PT	0.047uF	50V	F	
C 4160	K70167224	TANTALUM CAP.	DN1VR22H1S	0.22uF	35V		
C 4161	K22170809	CHIP CAP.	GRM40B222M50PT	0.0022uF	50V	B	
C 4162	K22141808	CHIP CAP.	GRM42-6B333M25PT	0.033uF	25V	B	
C 4163	K22170306	CHIP CAP.	GRM40UJ050C50PT	5pF	50V	UJ	
C 4164	K22170209	CHIP CAP.	GRM40CH080D50PT	8pF	50V	CH	
C 4165	K22170321	CHIP CAP.	GRM40UJ270J50PT	27pF	50V	UJ	
C 4166	K22170315	CHIP CAP.	GRM40UJ150J50PT	15pF	50V	UJ	
C 4167	K22170211	CHIP CAP.	GRM40CH100D50PT	10pF	50V	CH	
C 4168	K22170817	CHIP CAP.	GRM40B103M50PT	0.01uF	50V	B	

Local Unit Parts List

ADD	CODE NO	DESCRIPTION	DEVICE	TYP	VAL
C 4169	K40129038	AL. ELECTRO. CAP.	RC2-16V101MS(6X7)	100uF	16V
C 4170	K22170202	CHIP CAP.	GRM40CK010C50PT	1pF	50V CK
C 4171	K22170817	CHIP CAP.	GRM40B103M50PT	0.01uF	50V B
C 4172	K22170817	CHIP CAP.	GRM40B103M50PT	0.01uF	50V B
C 4173	K22170817	CHIP CAP.	GRM40B103M50PT	0.01uF	50V B
C 4174	K22170817	CHIP CAP.	GRM40B103M50PT	0.01uF	50V B
C 4175	K22170817	CHIP CAP.	GRM40B103M50PT	0.01uF	50V B
C 4176	K22170821	CHIP CAP.	GRM40B223M50PT	0.022uF	50V B
C 4177	K22141808	CHIP CAP.	GRM42-6B473M25PT	0.047uF	25V B
C 4178	K22170821	CHIP CAP.	GRM40B223M50PT	0.022uF	50V B
C 4181	K22170241	CHIP CAP.	GRM40CH181J50PT	180pF	50V CH
C 4182	K22170243	CHIP CAP.	GRM40CH221J50PT	220pF	50V CH
C 4183	K22170251	CHIP CAP.	GRM40CH471J50PT	470pF	50V CH
C 4184	K22170231	CHIP CAP.	GRM40CH680J50PT	68pF	50V CH
C 4185	K22170251	CHIP CAP.	GRM40CH471J50PT	470pF	50V CH
C 4186	K22141808	CHIP CAP.	GRM42-6B473M25PT	0.047uF	25V B
C 4187	K22171008	CHIP CAP.	GRM40F473Z50PT	0.047uF	50V F
C 4188	K22171008	CHIP CAP.	GRM40F473Z50PT	0.047uF	50V F
C 4189	K22170821	CHIP CAP.	GRM40B223M50PT	0.022uF	50V B
C 4190	K22170821	CHIP CAP.	GRM40B223M50PT	0.022uF	50V B
C 4191	K22170817	CHIP CAP.	GRM40B103M50PT	0.01uF	50V B
C 4192	K22170217	CHIP CAP.	GRM40CH180J50PT	18pF	50V CH
C 4193	K22170217	CHIP CAP.	GRM40CH180J50PT	18pF	50V CH
C 4194	K22170817	CHIP CAP.	GRM40B103M50PT	0.01uF	50V B
C 4195	K22170817	CHIP CAP.	GRM40B103M50PT	0.01uF	50V B
C 4196	K22170817	CHIP CAP.	GRM40B103M50PT	0.01uF	50V B
C 4197	K22170204	CHIP CAP.	GRM40CJ030C50PT	3pF	50V CJ
C 4198	K22170227	CHIP CAP.	GRM40CH470J50PT	47pF	50V CH
C 4199	K22170215	CHIP CAP.	GRM40CH150J50PT	15pF	50V CH
C 4200	K22170817	CHIP CAP.	GRM40B103M50PT	0.01uF	50V B
C 4201	K22170817	CHIP CAP.	GRM40B103M50PT	0.01uF	50V B
C 4202	K22170817	CHIP CAP.	GRM40B103M50PT	0.01uF	50V B
C 4203	K22170211	CHIP CAP.	GRM40CH100D50PT	10pF	50V CH
C 4204	K22170211	CHIP CAP.	GRM40CH100D50PT	10pF	50V CH
C 4205	K22170206	CHIP CAP.	GRM40CH050C50PT	5pF	50V CH
C 4206	K22170206	CHIP CAP.	GRM40CH050C50PT	5pF	50V CH
C 4207	K22170817	CHIP CAP.	GRM40B103M50PT	0.01uF	50V B
C 4209	K22170805	CHIP CAP.	GRM40B102M50PT	0.001uF	50V B
C 4210	K22170817	CHIP CAP.	GRM40B103M50PT	0.01uF	50V B
C 4211	K22170817	CHIP CAP.	GRM40B103M50PT	0.01uF	50V B
C 4212	K22170817	CHIP CAP.	GRM40B103M50PT	0.01uF	50V B
C 4213	K22170211	CHIP CAP.	GRM40CH100D50PT	10pF	50V CH
C 4214	K22170213	CHIP CAP.	GRM40CH120J50PT	12pF	50V CH
C 4215	K22170217	CHIP CAP.	GRM40CH180J50PT	18pF	50V CH
C 4216	K22170207	CHIP CAP.	GRM40CH060D50PT	6pF	50V CH
C 4217	K22170219	CHIP CAP.	GRM40CH220J50PT	22pF	50V CH
C 4218	K22170205	CHIP CAP.	GRM40CH040C50PT	4pF	50V CH
C 4219	K22170217	CHIP CAP.	GRM40CH180J50PT	18pF	50V CH
C 4220	K22170817	CHIP CAP.	GRM40B103M50PT	0.01uF	50V B
C 4221	K22170817	CHIP CAP.	GRM40B103M50PT	0.01uF	50V B
C 4223	K40129028	AL. ELECTRO. CAP.	RC2-16V470M(6X7)	47uF	16V
C 4224	K22170817	CHIP CAP.	GRM40B103M50PT	0.01uF	50V B
C 4225	K22170805	CHIP CAP.	GRM40B102M50PT	0.001uF	50V B
C 4226	K22170805	CHIP CAP.	GRM40B102M50PT	0.001uF	50V B
C 4227	K40149012	AL. ELECTRO. CAP.	RC2-25V100M(5X7)	10uF	25V
C 4228	K22170219	CHIP CAP.	GRM40CH220J50PT	22pF	50V CH
C 4229	K70167334	TANTALUM CAP.	DN1VR33M1S	0.33uF	35V
C 4230	K22141808	CHIP CAP.	GRM42-6B473M25PT	0.047uF	25V B
C 4231	K46120007	AL. ELECTRO. CAP.	16V101M6X7TR2	100uF	16V
C 4232	K22170817	CHIP CAP.	GRM40B103M50PT	0.01uF	50V B
C 4233	K22170805	CHIP CAP.	GRM40B102M50PT	0.001uF	50V B
C 4234	K22170221	CHIP CAP.	GRM40CH270J50PT	27pF	50V CH
C 4235	K22170205	CHIP CAP.	GRM40CH040C50PT	4pF	50V CH
C 4236	K22170221	CHIP CAP.	GRM40CH270J50PT	27pF	50V CH
C 4237	K22170205	CHIP CAP.	GRM40CH040C50PT	4pF	50V CH
C 4238	K22170217	CHIP CAP.	GRM40CH180J50PT	18pF	50V CH
C 4239	K22170817	CHIP CAP.	GRM40B103M50PT	0.01uF	50V B
C 4240	K40129028	AL. ELECTRO. CAP.	RC2-16V470M(6X7)	47uF	16V
C 4241	K22170817	CHIP CAP.	GRM40B103M50PT	0.01uF	50V B
C 4242	K40129038	AL. ELECTRO. CAP.	RC2-16V101MS(6X7)	100uF	16V
C 4243	K22170805	CHIP CAP.	GRM40B102M50PT	0.001uF	50V B
C 4244	K22170219	CHIP CAP.	GRM40CH220J50PT	22pF	50V CH
C 4245	K22170203	CHIP CAP.	GRM40CK020C50PT	2pF	50V CK
C 4246	K22170221	CHIP CAP.	GRM40CH270J50PT	27pF	50V CH
C 4247	K22170205	CHIP CAP.	GRM40CH040C50PT	4pF	50V CH
C 4248	K22170217	CHIP CAP.	GRM40CH180J50PT	18pF	50V CH
C 4249	K22170817	CHIP CAP.	GRM40B103M50PT	0.01uF	50V B
C 4250	K40129028	AL. ELECTRO. CAP.	RC2-16V470M(6X7)	47uF	16V
C 4251	K22170805	CHIP CAP.	GRM40B102M50PT	0.001uF	50V B
C 4252	K22170221	CHIP CAP.	GRM40CH270J50PT	27pF	50V CH
C 4253	K22170211	CHIP CAP.	GRM40CH100D50PT	10pF	50V CH
C 4254	K22170221	CHIP CAP.	GRM40CH270J50PT	27pF	50V CH

Local Unit Parts List

ADD	CODE NO	DESCRIPTION	DEVICE			TYP VAL	
C	4255	K22170209	CHIP CAP.	GRM40CH080D50PT	8pF	50V	CH
C	4256	K22170221	CHIP CAP.	GRM40CH270J50PT	27pF	50V	CH
C	4257	K22170817	CHIP CAP.	GRM40B103M50PT	0.01uF	50V	B
C	4258	K40129028	AL. ELECTRO. CAP.	RC2-16V470M(6X7)	47uF	16V	
C	4259	K22170805	CHIP CAP.	GRM40B102M50PT	0.001uF	50V	B
C	4260	K22170219	CHIP CAP.	GRM40CH220J50PT	22pF	50V	CH
C	4261	K22170209	CHIP CAP.	GRM40CH080D50PT	8pF	50V	CH
C	4262	K22170221	CHIP CAP.	GRM40CH270J50PT	27pF	50V	CH
C	4263	K22170207	CHIP CAP.	GRM40CH060D50PT	6pF	50V	CH
C	4264	K22170219	CHIP CAP.	GRM40CH220J50PT	22pF	50V	CH
C	4265	K22170817	CHIP CAP.	GRM40B103M50PT	0.01uF	50V	B
C	4266	K40129028	AL. ELECTRO. CAP.	RC2-16V470M(6X7)	47uF	16V	
C	4267	K22170203	CHIP CAP.	GRM40CK020C50PT	2pF	50V	CK
C	4268	K22170817	CHIP CAP.	GRM40B103M50PT	0.01uF	50V	B
C	4269	K22170201	CHIP CAP.	GRM40CK0R5C50PT	0.5pF	50V	CK
C	4270	K22170817	CHIP CAP.	GRM40B103M50PT	0.01uF	50V	B
C	4271	K22170805	CHIP CAP.	GRM40B102M50PT	0.001uF	50V	B
C	4272	K22170205	CHIP CAP.	GRM40CH040C50PT	4pF	50V	CH
C	4273	K22170206	CHIP CAP.	GRM40CH050C50PT	5pF	50V	CH
C	4274	K22170817	CHIP CAP.	GRM40B103M50PT	0.01uF	50V	B
C	4275	K22170805	CHIP CAP.	GRM40B102M50PT	0.001uF	50V	B
C	4276	K22170817	CHIP CAP.	GRM40B103M50PT	0.01uF	50V	B
C	4277	K22170817	CHIP CAP.	GRM40B103M50PT	0.01uF	50V	B
C	4278	K22170226	CHIP CAP.	GRM40CH390J50PT	39pF	50V	CH
C	4279	K22170231	CHIP CAP.	GRM40CH680J50PT	68pF	50V	CH
C	4280	K22170225	CHIP CAP.	GRM40CH390J50PT	39pF	50V	CH
C	4281	K22170817	CHIP CAP.	GRM40B103M50PT	0.01uF	50V	B
C	4282	K22170817	CHIP CAP.	GRM40B103M50PT	0.01uF	50V	B
C	4283	K22170817	CHIP CAP.	GRM40B103M50PT	0.01uF	50V	B
C	4285	K22171008	CHIP CAP.	GRM40F473Z50PT	0.047uF	50V	F
C	4286	K22170805	CHIP CAP.	GRM40B102M50PT	0.001uF	50V	B
C	4287	K22170805	CHIP CAP.	GRM40B102M50PT	0.001uF	50V	B
C	4288	K22170805	CHIP CAP.	GRM40B102M50PT	0.001uF	50V	B
C	4289	K22170805	CHIP CAP.	GRM40B102M50PT	0.001uF	50V	B
C	4290	K22170321	CHIP CAP.	GRM40UJ270J50PT	27pF	50V	UJ
C	4291	K22170817	CHIP CAP.	GRM40B103M50PT	0.01uF	50V	B
C	4292	K22170817	CHIP CAP.	GRM40B103M50PT	0.01uF	50V	B
C	4293	K22170817	CHIP CAP.	GRM40B103M50PT	0.01uF	50V	B
C	4294	K22141808	CHIP CAP.	GRM42-6B473M25PT	0.047uF	25V	B
C	4295	K22170817	CHIP CAP.	GRM40B103M50PT	0.01uF	50V	B
C	4296	K22170817	CHIP CAP.	GRM40B103M50PT	0.01uF	50V	B
C	4297	K22170223	CHIP CAP.	GRM40CH330J50PT	33pF	50V	CH
C	4298	K22170229	CHIP CAP.	GRM40CH560J50PT	56pF	50V	CH
C	4299	K40129038	AL. ELECTRO. CAP.	RC2-16V101MS(6X7)	100uF	16V	
C	4300	K40129038	AL. ELECTRO. CAP.	RC2-16V101MS(6X7)	100uF	16V	
C	4301	K22170208	CHIP CAP.	GRM40CH070D50PT	7pF	50V	CH
C	4302	K46170030	AL. ELECTRO. CAP.	50V010M4X7TR2	1uF	50V	
C	4303	K22171008	CHIP CAP.	GRM40F473Z50PT	0.047uF	50V	F
C	4304	K22170213	CHIP CAP.	GRM40CH120J50PT	12pF	50V	CH
C	4305	K22170805	CHIP CAP.	GRM40B102M50PT	0.001uF	50V	B
C	4306	K22170805	CHIP CAP.	GRM40B102M50PT	0.001uF	50V	B
D	4001	G2090180	DIODE	FC-53M-5			
D	4002	G2090180	DIODE	FC-53M-5			
D	4003	G2090152	DIODE	RD5.1EB2			
D	4004	G2090023	DIODE	1SV50			
D	4005	G2090023	DIODE	1SV50			
D	4007	G2090165	DIODE	FC-52M-5			
D	4008	G2060002	DIODE	1SS53T1			
D	4009	G2090165	DIODE	FC-52M-5			
D	4010	G2060002	DIODE	1SS53T1			
D	4011	G2090165	DIODE	FC-52M-5			
D	4013	G2060002	DIODE	1SS53T1			
D	4014	G2090165	DIODE	FC-52M-5			
D	4016	G2060002	DIODE	1SS53T1			
D	4017	G2070009	DIODE	1SS184 TE85R			
D	4018	G2070009	DIODE	1SS184 TE85R			
D	4019	G2070009	DIODE	1SS184 TE85R			
D	4020	G2070009	DIODE	1SS184 TE85R			
D	4021	G2070009	DIODE	1SS184 TE85R			
D	4022	G2070001	DIODE	1SS181 TE85R			
D	4023	G2090225	DIODE	HZ6C2L			
J	4001	P0090622	CONNECTOR	SC25-03WS			
J	4002	P1090210	CONNECTOR	TMP-JV			
J	4003	P1090210	CONNECTOR	TMP-JV			
J	4004	P0090622	CONNECTOR	SC25-03WS			
J	4005	P1090210	CONNECTOR	TMP-JV			
J	4006	P1090210	CONNECTOR	TMP-JV			
J	4008	P0090627	CONNECTOR	SC25-08WS			
J	4009	P0090625	CONNECTOR	SC25-06WS			
J	4010	P0090625	CONNECTOR	SC25-06WS			
J	4011	P1090210	CONNECTOR	TMP-JV			
J	4012	P0090623	CONNECTOR	SC25-04WS			
J	4013	P0090621	CONNECTOR	SC25-02WS			

Local Unit Parts List

ADD	CODE NO	DESCRIPTION	DEVICE	TYP VAL	
J	4014	P1090210	CONNECTOR	TMP-JV	
J	4015	P1090210	CONNECTOR	TMP-JV	
L	4001	L1790047	M.RFC	LAP02TA1R2K	1.2u
L	4002	L1790045	M.RFC	LAP02TAR82K	0.82uH
L	4003	L1790045	M.RFC	LAP02TAR82K	0.82uH
L	4004	L1790044	M.RFC	LAP02TAR68K	0.68uH
L	4005	L1790044	M.RFC	LAP02TAR68K	0.68uH
L	4006	L1790045	M.RFC	LAP02TAR82K	0.82uH
L	4007	L1790045	M.RFC	LAP02TAR82K	0.82uH
L	4008	L1790045	M.RFC	LAP02TAR82K	0.82uH
L	4009	L1790045	M.RFC	LAP02TAR82K	0.82uH
L	4010	L1790044	M.RFC	LAP02TAR68K	0.68uH
L	4011	L1790044	M.RFC	LAP02TAR68K	0.68uH
L	4012	L1790045	M.RFC	LAP02TAR82K	0.82uH
L	4013	L1790045	M.RFC	LAP02TAR82K	0.82uH
L	4014	L1790045	M.RFC	LAP02TAR82K	0.82uH
L	4015	L1790045	M.RFC	LAP02TAR82K	0.82uH
L	4016	L1790045	M.RFC	LAP02TAR82K	0.82uH
L	4017	L1790045	M.RFC	LAP02TAR82K	0.82uH
L	4018	L1790058	M.RFC	LAP02TA100K	10uH
L	4019	L1790065	M.RFC	LAP02TA390K	39uH
L	4020	L1790070	M.RFC	LAP02TA101K	100uH
L	4021	L1790070	M.RFC	LAP02TA101K	100uH
L	4022	L1790046	M.RFC	LAP02TA1R0K	1uH
L	4023	L1790044	M.RFC	LAP02TAR68K	0.68uH
L	4024	L1790047	M.RFC	LAP02TA1R2K	1.2u
L	4025	L1790056	M.RFC	LAP02TA6R8K	6.8uH
L	4026	L1790046	M.RFC	LAP02TA1R0K	1uH
L	4027	L1790048	M.RFC	LAP02TA1R5K	1.5u
L	4028	L1790161	M.RFC	LAL03VB561K	560uH
L	4029	L1790070	M.RFC	LAP02TA101K	100uH
L	4030	L1790162	M.RFC	LAL03VB681K	680uH
L	4031	L1790061	M.RFC	LAP02TA180K	18uH
L	4032	L1790061	M.RFC	LAP02TA180K	18uH
L	4033	L1790046	M.RFC	LAP02TA1R0K	1uH
L	4034	L1790160	M.RFC	LAL03VB471K	470uH
L	4035	L1790046	M.RFC	LAP02TA1R0K	1uH
L	4036	L1790160	M.RFC	LAL03VB471K	470uH
L	4037	L1790161	M.RFC	LAL03VB561K	560uH
L	4040	L1790050	M.RFC	LAP02TA2R2K	2.2uH
L	4041	L1790050	M.RFC	LAP02TA2R2K	2.2uH
L	4042	L0190025	COIL	S18	
L	4043	L1790051	M.RFC	LAP02TA2R7K	2.7u
L	4044	L1190300	M.RFC	LAL02NA270M	27uH
L	4045	L1190302	M.RFC	LAL02NA390M	39uH
L	4046	L1790043	M.RFC	LAP02TAR56K	0.56uH
L	4047	L1790044	M.RFC	LAP02TAR68K	0.68uH
L	4048	L1190279	M.RFC	LAL02NAR47M	0.47uH
L	4049	L1190281	M.RFC	LAL02NAR68M	0.68uH
L	4050	L1190283	M.RFC	LAL02NA1R0M	1uH
L	4051	L1790070	M.RFC	LAP02TA101K	100uH
L	4052	L1790054	M.RFC	LAP02TA4R7K	4.7uH
L	4053	L0190164	COIL	S18 M55T	
L	4054	L1790053	M.RFC	LAP02TA3R9K	3.9uH
L	4055	L1790070	M.RFC	LAP02TA101K	100uH
L	4056	L1790054	M.RFC	LAP02TA4R7K	4.7uH
L	4057	L0190164	COIL	S18 M55T	
L	4058	L1790052	M.RFC	LAP02TA3R3K	3.3uH
L	4059	L1790054	M.RFC	LAP02TA4R7K	4.7uH
L	4060	L0190165	COIL	S18 M33T	
L	4061	L1790052	M.RFC	LAP02TA3R3K	3.3uH
L	4062	L1790054	M.RFC	LAP02TA4R7K	4.7uH
L	4063	L0190165	COIL	S18 M33T	
L	4064	L1790050	M.RFC	LAP02TA2R2K	2.2uH
L	4065	L1790042	M.RFC	LAP02TAR47K	0.47uH
L	4066	L0021820	COIL	5.5T3.5D0.6UEW R	
L	4067	L0021820	COIL	5.5T3.5D0.6UEW R	
L	4068	L1790046	M.RFC	LAP02TA1R0K	1uH
L	4069	L0021554	COIL	0.82U	
L	4070	L0021267	COIL	1.00U R12-1377X	
L	4071	L0021554	COIL	0.82U	
L	4072	L1790038	M.RFC	LAP02TAR22K	0.22uH
L	4073	L1790038	M.RFC	LAP02TAR22K	0.22uH
L	4074	L1790070	M.RFC	LAP02TA101K	100uH
L	4075	L1790070	M.RFC	LAP02TA101K	100uH
Q	4001	G3326197B	TRANSISTOR	2SC2619FBTR	
Q	4002	G3326197B	TRANSISTOR	2SC2619FBTR	
Q	4003	G3326207B	TRANSISTOR	2SC2620QBTR	
Q	4004	G3326207B	TRANSISTOR	2SC2620QBTR	
Q	4005	G1090101	IC	UPC1037H	
Q	4006	G3327127G	TRANSISTOR	2SC2712GR TE85R	
Q	4007	G1090109	IC	SN74LS390N	

For Service Manuals Contact
MAURITRON TECHNICAL SERVICES
 8 Cherry Tree Rd. Chinnor
 Oxon OX9 4QY
 Tel: 01844-351694 Fax: 01844-352554
 Email: enquiries@mauritron.co.uk

Local Unit Parts List

ADD	CODE NO	DESCRIPTION	DEVICE	TYP	VAL
Q 4008	G1090473	IC	TC5081AP		
Q 4009	G3326207B	TRANSISTOR	2SC2620QBTR		
Q 4010	G3326207B	TRANSISTOR	2SC2620QBTR		
Q 4011	G3326207B	TRANSISTOR	2SC2620QBTR		
Q 4012	G3803027Y	FET	2SK302Y TE85R		
Q 4013	G1090299	IC	UPC7805H		
Q 4014	G3326207B	TRANSISTOR	2SC2620QBTR		
Q 4015	G3326207B	TRANSISTOR	2SC2620QBTR		
Q 4016	G3326197B	TRANSISTOR	2SC2619FBTR		
Q 4017	G1090101	IC	UPC1037H		
Q 4018	G3326207B	TRANSISTOR	2SC2620QBTR		
Q 4019	G3326207B	TRANSISTOR	2SC2620QBTR		
Q 4020	G3326207B	TRANSISTOR	2SC2620QBTR		
Q 4021	G3326197B	TRANSISTOR	2SC2619FBTR		
Q 4022	G1090101	IC	UPC1037H		
Q 4023	G1090473	IC	TC5081AP		
Q 4024	G3327127G	TRANSISTOR	2SC2712GR TE85R		
Q 4025	G1090974	IC	TC4S584F TE85R		
Q 4026	G3326207B	TRANSISTOR	2SC2620QBTR		
Q 4027	G3326197B	TRANSISTOR	2SC2619FBTR		
Q 4028	G1090101	IC	UPC1037H		
Q 4029	G3326207B	TRANSISTOR	2SC2620QBTR		
Q 4030	G3327127G	TRANSISTOR	2SC2712GR TE85R		
Q 4031	G1090974	IC	TC4S584F TE85R		
Q 4032	G1090473	IC	TC5081AP		
Q 4033	G3801921B	FET	2SK192A-BL		
Q 4034	G3803027Y	FET	2SK302Y TE85R		
Q 4035	G3326207B	TRANSISTOR	2SC2620QBTR		
Q 4036	G1090101	IC	UPC1037H		
Q 4039	G3327127G	TRANSISTOR	2SC2712GR TE85R		
Q 4040	G1090974	IC	TC4S584F TE85R		
Q 4041	G1090101	IC	UPC1037H		
Q 4042	G3326207B	TRANSISTOR	2SC2620QBTR		
Q 4043	G3326197B	TRANSISTOR	2SC2619FBTR		
Q 4044	G1090101	IC	UPC1037H		
Q 4045	G3326207B	TRANSISTOR	2SC2620QBTR		
Q 4046	G1090834	IC	CX-7925B		
Q 4047	G3802087Y	FET	2SK208Y TE85R		
Q 4048	G3327127G	TRANSISTOR	2SC2712GR TE85R		
Q 4049	G3327127G	TRANSISTOR	2SC2712GR TE85R		
Q 4050	G3801921G	FET	2SK192AGR		
Q 4051	G3070001	TRANSISTOR	FA1A4M-T2B		
Q 4052	G3801921G	FET	2SK192AGR		
Q 4053	G3070001	TRANSISTOR	FA1A4M-T2B		
Q 4054	G3801921G	FET	2SK192AGR		
Q 4055	G3070001	TRANSISTOR	FA1A4M-T2B		
Q 4056	G3801921G	FET	2SK192AGR		
Q 4057	G3070001	TRANSISTOR	FA1A4M-T2B		
Q 4058	G3803027Y	FET	2SK302Y-TE85R		
Q 4059	G3327147Y	TRANSISTOR	2SC2714YTE85R		
Q 4060	G3327147Y	TRANSISTOR	2SC2714YTE85R		
Q 4061	G3320260	TRANSISTOR	2SC2026		
Q 4062	G1090049	IC	MC14008BCP		
Q 4063	G1090049	IC	MC14008BCP		
Q 4065	G3070001	TRANSISTOR	FA1A4M-T2B		
Q 4066	G3070001	TRANSISTOR	FA1A4M-T2B		
Q 4067	G3070001	TRANSISTOR	FA1A4M-T2B		
Q 4068	G3327147Y	TRANSISTOR	2SC2714YTE85R		
Q 4069	G3070001	TRANSISTOR	FA1A4M-T2B		
Q 4070	G3070001	TRANSISTOR	FA1A4M-T2B		
Q 4071	G1090994	IC	MC14013BFL		
R 4001	J24205223	CHIP RES.	RMC1/10T 223J	22K	1/10W
R 4002	J24205682	CHIP RES.	RMC1/10T 682J	6.8K	1/10W
R 4003	J24205331	CHIP RES.	RMC1/10T 331J	330	1/10W
R 4004	J24205101	CHIP RES.	RMC1/10T 101J	100	1/10W
R 4005	J24205101	CHIP RES.	RMC1/10T 101J	100	1/10W
R 4006	J24205101	CHIP RES.	RMC1/10T 101J	100	1/10W
R 4007	J24205101	CHIP RES.	RMC1/10T 101J	100	1/10W
R 4008	J24205680	CHIP RES.	RMC1/10T 680J	68	1/10W
R 4009	J24205223	CHIP RES.	RMC1/10T 223J	22K	1/10W
R 4010	J24205682	CHIP RES.	RMC1/10T 682J	6.8K	1/10W
R 4011	J24205331	CHIP RES.	RMC1/10T 331J	330	1/10W
R 4012	J24205101	CHIP RES.	RMC1/10T 101J	100	1/10W
R 4013	J24205101	CHIP RES.	RMC1/10T 101J	100	1/10W
R 4014	J24205101	CHIP RES.	RMC1/10T 101J	100	1/10W
R 4015	J24205101	CHIP RES.	RMC1/10T 101J	100	1/10W
R 4016	J24205101	CHIP RES.	RMC1/10T 101J	100	1/10W
R 4017	J24205680	CHIP RES.	RMC1/10T 680J	68	1/10W
R 4018	J24205680	CHIP RES.	RMC1/10T 680J	68	1/10W
R 4019	J24205223	CHIP RES.	RMC1/10T 223J	22K	1/10W
R 4020	J24205682	CHIP RES.	RMC1/10T 682J	6.8K	1/10W
R 4021	J24205471	CHIP RES.	RMC1/10T 471J	470	1/10W
R 4022	J24205101	CHIP RES.	RMC1/10T 101J	100	1/10W

Local Unit Parts List

ADD	CODE NO	DESCRIPTION	DEVICE	TYP	VAL
R 4023	J24205223	CHIP RES.	RMC1/10T 223J	22K	1/10W
R 4024	J24205682	CHIP RES.	RMC1/10T 682J	6.8K	1/10W
R 4025	J24205331	CHIP RES.	RMC1/10T 331J	330	1/10W
R 4026	J24205101	CHIP RES.	RMC1/10T 101J	100	1/10W
R 4027	J24205151	CHIP RES.	RMC1/10T 151J	150	1/10W
R 4028	J24205331	CHIP RES.	RMC1/10T 331J	330	1/10W
R 4029	J24205104	CHIP RES.	RMC1/10T 104J	100K	1/10W
R 4030	J24205102	CHIP RES.	RMC1/10T 102J	1K	1/10W
R 4031	J24205334	CHIP RES.	RMC1/10T 334J	330K	1/10W
R 4032	J24205102	CHIP RES.	RMC1/10T 102J	1K	1/10W
R 4033	J24205681	CHIP RES.	RMC1/10T 681J	680	1/10W
R 4034	J24205680	CHIP RES.	RMC1/10T 680J	68	1/10W
R 4035	J24205473	CHIP RES.	RMC1/10T 473J	47K	1/10W
R 4036	J24205332	CHIP RES.	RMC1/10T 332J	3.3K	1/10W
R 4037	J24205153	CHIP RES.	RMC1/10T 153J	15K	1/10W
R 4038	J24205223	CHIP RES.	RMC1/10T 223J	22K	1/10W
R 4039	J24205331	CHIP RES.	RMC1/10T 331J	330	1/10W
R 4040	J24205101	CHIP RES.	RMC1/10T 101J	100	1/10W
R 4041	J24205104	CHIP RES.	RMC1/10T 104J	100K	1/10W
R 4042	J24205471	CHIP RES.	RMC1/10T 471J	470	1/10W
R 4043	J24205101	CHIP RES.	RMC1/10T 101J	100	1/10W
R 4044	J24205223	CHIP RES.	RMC1/10T 223J	22K	1/10W
R 4045	J24205682	CHIP RES.	RMC1/10T 682J	6.8K	1/10W
R 4046	J24205331	CHIP RES.	RMC1/10T 331J	330	1/10W
R 4047	J24205101	CHIP RES.	RMC1/10T 101J	100	1/10W
R 4048	J24205473	CHIP RES.	RMC1/10T 473J	47K	1/10W
R 4049	J24205471	CHIP RES.	RMC1/10T 471J	470	1/10W
R 4050	J24205470	CHIP RES.	RMC1/10T 470J	47	1/10W
R 4052	J24205153	CHIP RES.	RMC1/10T 153J	15K	1/10W
R 4053	J24205332	CHIP RES.	RMC1/10T 332J	3.3K	1/10W
R 4054	J24205153	CHIP RES.	RMC1/10T 153J	15K	1/10W
R 4055	J24205104	CHIP RES.	RMC1/10T 104J	100K	1/10W
R 4056	J24205332	CHIP RES.	RMC1/10T 332J	3.3K	1/10W
R 4057	J24205104	CHIP RES.	RMC1/10T 104J	100K	1/10W
R 4058	J24205681	CHIP RES.	RMC1/10T 681J	680	1/10W
R 4059	J24205101	CHIP RES.	RMC1/10T 101J	100	1/10W
R 4060	J24205101	CHIP RES.	RMC1/10T 101J	100	1/10W
R 4061	J24205104	CHIP RES.	RMC1/10T 104J	100K	1/10W
R 4062	J24205681	CHIP RES.	RMC1/10T 681J	680	1/10W
R 4063	J24205682	CHIP RES.	RMC1/10T 682J	6.8K	1/10W
R 4064	J24205223	CHIP RES.	RMC1/10T 223J	22K	1/10W
R 4065	J24205681	CHIP RES.	RMC1/10T 681J	680	1/10W
R 4066	J24205101	CHIP RES.	RMC1/10T 101J	100	1/10W
R 4067	J24205680	CHIP RES.	RMC1/10T 680J	68	1/10W
R 4068	J24205223	CHIP RES.	RMC1/10T 223J	22K	1/10W
R 4069	J24205682	CHIP RES.	RMC1/10T 682J	6.8K	1/10W
R 4070	J24205331	CHIP RES.	RMC1/10T 331J	330	1/10W
R 4071	J24205101	CHIP RES.	RMC1/10T 101J	100	1/10W
R 4072	J24205151	CHIP RES.	RMC1/10T 151J	150	1/10W
R 4073	J24205332	CHIP RES.	RMC1/10T 332J	3.3K	1/10W
R 4074	J24205104	CHIP RES.	RMC1/10T 104J	100K	1/10W
R 4075	J24205681	CHIP RES.	RMC1/10T 681J	680	1/10W
R 4076	J24205101	CHIP RES.	RMC1/10T 101J	100	1/10W
R 4077	J24205221	CHIP RES.	RMC1/10T 221J	220	1/10W
R 4078	J24205104	CHIP RES.	RMC1/10T 104J	100K	1/10W
R 4079	J24205101	CHIP RES.	RMC1/10T 101J	100	1/10W
R 4080	J24205681	CHIP RES.	RMC1/10T 681J	680	1/10W
R 4081	J24205682	CHIP RES.	RMC1/10T 682J	6.8K	1/10W
R 4082	J24205223	CHIP RES.	RMC1/10T 223J	22K	1/10W
R 4083	J24205681	CHIP RES.	RMC1/10T 681J	680	1/10W
R 4084	J24205101	CHIP RES.	RMC1/10T 101J	100	1/10W
R 4085	J24205151	CHIP RES.	RMC1/10T 151J	150	1/10W
R 4086	J24205331	CHIP RES.	RMC1/10T 331J	330	1/10W
R 4087	J24205225	CHIP RES.	RMC1/10T 225J	2.2M	1/10W
R 4088	J24205104	CHIP RES.	RMC1/10T 104J	100K	1/10W
R 4089	J24205151	CHIP RES.	RMC1/10T 151J	150	1/10W
R 4090	J24205102	CHIP RES.	RMC1/10T 102J	1K	1/10W
R 4091	J24205470	CHIP RES.	RMC1/10T 470J	47	1/10W
R 4092	J24205104	CHIP RES.	RMC1/10T 104J	100K	1/10W
R 4093	J24205681	CHIP RES.	RMC1/10T 681J	680	1/10W
R 4094	J24205101	CHIP RES.	RMC1/10T 101J	100	1/10W
R 4095	J24205101	CHIP RES.	RMC1/10T 101J	100	1/10W
R 4096	J24205104	CHIP RES.	RMC1/10T 104J	100K	1/10W
R 4097	J24205102	CHIP RES.	RMC1/10T 102J	1K	1/10W
R 4099	J24205151	CHIP RES.	RMC1/10T 151J	150	1/10W
R 4100	J24205101	CHIP RES.	RMC1/10T 101J	100	1/10W
R 4101	J24205101	CHIP RES.	RMC1/10T 101J	100	1/10W
R 4102	J24205682	CHIP RES.	RMC1/10T 682J	6.8K	1/10W
R 4103	J24205223	CHIP RES.	RMC1/10T 223J	22K	1/10W
R 4104	J24205331	CHIP RES.	RMC1/10T 331J	330	1/10W
R 4106	J24205680	CHIP RES.	RMC1/10T 680J	68	1/10W
R 4108	J24205104	CHIP RES.	RMC1/10T 104J	100K	1/10W
R 4109	J24205151	CHIP RES.	RMC1/10T 151J	150	1/10W

For Service Manuals Contact
MAURITRON TECHNICAL SERVICES
 8 Cherry Tree Rd. Chinnor
 Oxon OX9 4QY
 Tel: 01844-351654 Fax: 01844-352554
 Email: enquiries@mauritron.co.uk

Local Unit Parts List

ADD	CODE NO	DESCRIPTION	DEVICE	TYP	VAL
R 4110	J24205102	CHIP RES.	RMC1/10T 102J	1K	1/10W
R 4111	J24205470	CHIP RES.	RMC1/10T 470J	47	1/10W
R 4112	J24205103	CHIP RES.	RMC1/10T 103J	10K	1/10W
R 4113	J24205561	CHIP RES.	RMC1/10T 561J	560	1/10W
R 4115	J24205182	CHIP RES.	RMC1/10T 182J	1.8K	1/10W
R 4116	J24205104	CHIP RES.	RMC1/10T 104J	100K	1/10W
R 4117	J24205151	CHIP RES.	RMC1/10T 151J	150	1/10W
R 4118	J24205101	CHIP RES.	RMC1/10T 101J	100	1/10W
R 4119	J24205104	CHIP RES.	RMC1/10T 104J	100K	1/10W
R 4120	J24205101	CHIP RES.	RMC1/10T 101J	100	1/10W
R 4121	J24205470	CHIP RES.	RMC1/10T 470J	47	1/10W
R 4122	J24205102	CHIP RES.	RMC1/10T 102J	1K	1/10W
R 4123	J24205221	CHIP RES.	RMC1/10T 221J	220	1/10W
R 4124	J24205104	CHIP RES.	RMC1/10T 104J	100K	1/10W
R 4125	J24205101	CHIP RES.	RMC1/10T 101J	100	1/10W
R 4126	J24205681	CHIP RES.	RMC1/10T 681J	680	1/10W
R 4127	J24205151	CHIP RES.	RMC1/10T 151J	150	1/10W
R 4129	J24205104	CHIP RES.	RMC1/10T 104J	100K	1/10W
R 4130	J24205151	CHIP RES.	RMC1/10T 151J	150	1/10W
R 4131	J24205102	CHIP RES.	RMC1/10T 102J	1K	1/10W
R 4132	J24205101	CHIP RES.	RMC1/10T 101J	100	1/10W
R 4133	J24205151	CHIP RES.	RMC1/10T 151J	150	1/10W
R 4134	J24205104	CHIP RES.	RMC1/10T 104J	100K	1/10W
R 4135	J24205221	CHIP RES.	RMC1/10T 221J	220	1/10W
R 4136	J24205102	CHIP RES.	RMC1/10T 102J	1K	1/10W
R 4137	J24205681	CHIP RES.	RMC1/10T 681J	680	1/10W
R 4138	J24205104	CHIP RES.	RMC1/10T 104J	100K	1/10W
R 4139	J24205681	CHIP RES.	RMC1/10T 681J	680	1/10W
R 4141	J24205151	CHIP RES.	RMC1/10T 151J	150	1/10W
R 4142	J24205331	CHIP RES.	RMC1/10T 331J	330	1/10W
R 4143	J24205104	CHIP RES.	RMC1/10T 104J	100K	1/10W
R 4144	J24205101	CHIP RES.	RMC1/10T 101J	100	1/10W
R 4145	J24205101	CHIP RES.	RMC1/10T 101J	100	1/10W
R 4146	J24205471	CHIP RES.	RMC1/10T 471J	470	1/10W
R 4147	J24205103	CHIP RES.	RMC1/10T 103J	10K	1/10W
R 4148	J24205682	CHIP RES.	RMC1/10T 682J	6.8K	1/10W
R 4149	J24205681	CHIP RES.	RMC1/10T 681J	680	1/10W
R 4150	J24205471	CHIP RES.	RMC1/10T 471J	470	1/10W
R 4151	J24205122	CHIP RES.	RMC1/10T 122J	1.2K	1/10W
R 4152	J24205182	CHIP RES.	RMC1/10T 182J	1.8K	1/10W
R 4154	J24205680	CHIP RES.	RMC1/10T 680J	68	1/10W
R 4155	J24205104	CHIP RES.	RMC1/10T 104J	100K	1/10W
R 4156	J24205101	CHIP RES.	RMC1/10T 101J	100	1/10W
R 4157	J24205222	CHIP RES.	RMC1/10T 222J	2.2K	1/10W
R 4158	J24205223	CHIP RES.	RMC1/10T 223J	22K	1/10W
R 4159	J24205101	CHIP RES.	RMC1/10T 101J	100	1/10W
R 4160	J24205104	CHIP RES.	RMC1/10T 104J	100K	1/10W
R 4161	J24205101	CHIP RES.	RMC1/10T 101J	100	1/10W
R 4162	J24205223	CHIP RES.	RMC1/10T 223J	22K	1/10W
R 4163	J24205101	CHIP RES.	RMC1/10T 101J	100	1/10W
R 4164	J24205104	CHIP RES.	RMC1/10T 104J	100K	1/10W
R 4165	J24205101	CHIP RES.	RMC1/10T 101J	100	1/10W
R 4166	J24205223	CHIP RES.	RMC1/10T 223J	22K	1/10W
R 4167	J24205101	CHIP RES.	RMC1/10T 101J	100	1/10W
R 4168	J24205104	CHIP RES.	RMC1/10T 104J	100K	1/10W
R 4169	J24205101	CHIP RES.	RMC1/10T 101J	100	1/10W
R 4170	J24205223	CHIP RES.	RMC1/10T 223J	22K	1/10W
R 4171	J24205101	CHIP RES.	RMC1/10T 101J	100	1/10W
R 4172	J24205104	CHIP RES.	RMC1/10T 104J	100K	1/10W
R 4173	J24205470	CHIP RES.	RMC1/10T 470J	47	1/10W
R 4174	J24205102	CHIP RES.	RMC1/10T 102J	1K	1/10W
R 4175	J24205101	CHIP RES.	RMC1/10T 101J	100	1/10W
R 4176	J24205104	CHIP RES.	RMC1/10T 104J	100K	1/10W
R 4177	J24205471	CHIP RES.	RMC1/10T 471J	470	1/10W
R 4178	J24205682	CHIP RES.	RMC1/10T 682J	6.8K	1/10W
R 4179	J24205223	CHIP RES.	RMC1/10T 223J	22K	1/10W
R 4180	J24205471	CHIP RES.	RMC1/10T 471J	470	1/10W
R 4181	J24205101	CHIP RES.	RMC1/10T 101J	100	1/10W
R 4182	J24205272	CHIP RES.	RMC1/10T 272J	2.7K	1/10W
R 4183	J24205682	CHIP RES.	RMC1/10T 682J	6.8K	1/10W
R 4184	J24205101	CHIP RES.	RMC1/10T 101J	100	1/10W
R 4185	J24205101	CHIP RES.	RMC1/10T 101J	100	1/10W
R 4186	J24205104	CHIP RES.	RMC1/10T 104J	100K	1/10W
R 4187	J24205104	CHIP RES.	RMC1/10T 104J	100K	1/10W
R 4188	J24205104	CHIP RES.	RMC1/10T 104J	100K	1/10W
R 4189	J24205104	CHIP RES.	RMC1/10T 104J	100K	1/10W
R 4190	J24205104	CHIP RES.	RMC1/10T 104J	100K	1/10W
R 4191	J24205102	CHIP RES.	RMC1/10T 102J	1K	1/10W
R 4192	J24205104	CHIP RES.	RMC1/10T 104J	100K	1/10W
R 4193	J24205104	CHIP RES.	RMC1/10T 104J	100K	1/10W
R 4194	J24205104	CHIP RES.	RMC1/10T 104J	100K	1/10W
R 4195	J24205104	CHIP RES.	RMC1/10T 104J	100K	1/10W
R 4196	J24205104	CHIP RES.	RMC1/10T 104J	100K	1/10W

Local Unit Parts List

ADD	CODE NO	DESCRIPTION	DEVICE	TYP	VAL
R 4197	J24205822	CHIP RES.	RMC1/10T 822J	8.2K	1/10W
R 4198	J24205272	CHIP RES.	RMC1/10T 272J	2.7K	1/10W
R 4199	J24205471	CHIP RES.	RMC1/10T 471J	470	1/10W
R 4200	J24205331	CHIP RES.	RMC1/10T 331J	330	1/10W
R 4202	J24205101	CHIP RES.	RMC1/10T 101J	100	1/10W
R 4203	J24205331	CHIP RES.	RMC1/10T 331J	330	1/10W
R 4204	J24205820	CHIP RES.	RMC1/10T 820J	82	1/10W
R 4205	J24205104	CHIP RES.	RMC1/10T 104J	100K	1/10W
R 4206	J24205272	CHIP RES.	RMC1/10T 272J	2.7K	1/10W
R 4207	J24205102	CHIP RES.	RMC1/10T 102J	1K	1/10W
R 4208	J24205102	CHIP RES.	RMC1/10T 102J	1K	1/10W
R 4209	J24205222	CHIP RES.	RMC1/10T 222J	2.2K	1/10W
R 4210	J24205222	CHIP RES.	RMC1/10T 222J	2.2K	1/10W
R 4211	J24205681	CHIP RES.	RMC1/10T 681J	680	1/10W
R 4212	J24205102	CHIP RES.	RMC1/10T 102J	1K	1/10W
R 4213	J07225101	CARBON FILM RES.	RD16TPJ101 100	100	1/6W
R 4214	J24205562	CHIP RES.	RMC1/10T 562J	5.6K	1/10W
R 4215	J24205102	CHIP RES.	RMC1/10T 102J	1K	1/10W
R 4216	J24205102	CHIP RES.	RMC1/10T 102J	1K	1/10W
T 4001	L0021968	COIL	1-1 RID-Q5B		
T 4002	L0021161	COIL	10.7M R12-5668A		
T 4003	L0021161	COIL	10.7M R12-5668A		
T 4004	L0021929	COIL	62.92M R12-J562A		
T 4005	L0021930	COIL	31.46M R12-J536A		
T 4006	L0021930	COIL	31.46M R12-J536A		
T 4007	L0021944	COIL	65.405M R-J768A		
T 4008	L0021944	COIL	65.405M R-J768A		
T 4009	L0021931	COIL	12.635M R-H955A		
T 4010	L0021395	COIL	8.21M R12-6367A		
T 4011	L0021199	COIL	8.20M R12-4043A		
T 4012	L0021199	COIL	8.20M R12-4043A		
T 4013	L0021484	COIL			
T 4014	L0021932	COIL	61.44M R12-H956A		
T 4015	L0021932	COIL	61.44M R12-H956A		
T 4016	L0021932	COIL	61.44M R12-H956A		
TC4001	K91000028	TRIMMER CAP.	ECV1ZW10X53T	10PF	10pF
TC4002	K91000055	TRIMMER CAP.	ECV1ZW06X53T	6PF	6pF
TC4003	K91000055	TRIMMER CAP.	ECV1ZW06X53T	6PF	6pF
TC4004	K91000055	TRIMMER CAP.	ECV1ZW06X53T	6PF	6pF
TC4005	K91000055	TRIMMER CAP.	ECV1ZW06X53T	6PF	6pF
TC4006	K91000157	TRIMMER CAP.	TZB04N100BC	10PF	10pF
TC4007	K91000157	TRIMMER CAP.	TZB04N100BC	10PF	10pF
TP4001	Q5000026	TP-F	TP-F IPS-1032		
TP4002	Q5000026	TP-F	TP-F IPS-1032		
TP4003	Q5000026	TP-F	TP-F IPS-1032		
TP4004	Q5000026	TP-F	TP-F IPS-1032		
TP4005	Q5000026	TP-F	TP-F IPS-1032		
TP4006	Q5000026	TP-F	TP-F IPS-1032		
TP4007	Q5000026	TP-F	TP-F IPS-1032		
TP4008	Q5000026	TP-F	TP-F IPS-1032		
TP4009	Q5000026	TP-F	TP-F IPS-1032		
X 4001	H0102929	XTAL		65.405MHZ	
X 4002	H0102928	XTAL		52.77MHZ	
X 4003	H0102926	XTAL		52.64488MHZ	
				Z	
X 4004	H0102927	XTAL		8.8156MHZ	
XF4001	H1102153	XTAL	65R10AU		
XF4002	H1102168	XTAL	8.6M10B		
XF4003	H1102168	XTAL	8.6M10B		

For Service Manuals Contact
MAURITRON TECHNICAL SERVICES
 8 Cherry Tree Rd. Chinnor
 Oxon OX9 4QY
 Tel: 01844-351694 Fax: 01844-352554
 Email: enquiries@mauritron.co.uk

Notes

For Service Manuals Contact
MAURITRON TECHNICAL SERVICES
8 Cherry Tree Rd, Chinnor
Oxon OX9 4DY
Tel:- 01844-351694 Fax:- 01844-352554
Email:- enquiries@mauritron.co.uk

For Service Manuals Contact
MAURITRON TECHNICAL SERVICES
8 Cherry Tree Rd, Chinnor
Oxon OX9 4QY
Tel: 01844-351694 Fax: 01844-352554
Email: enquires@mauritron.co.uk

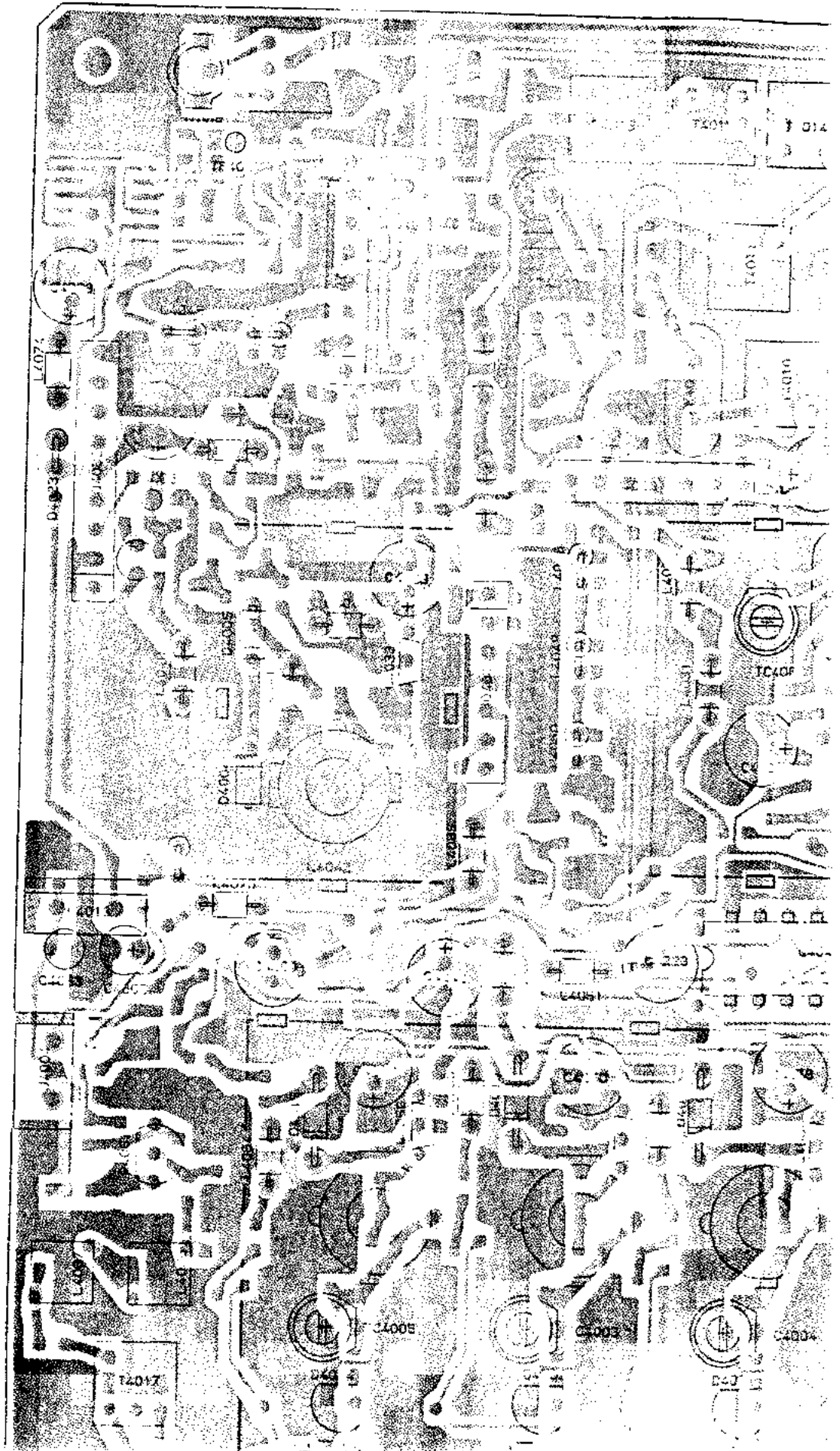

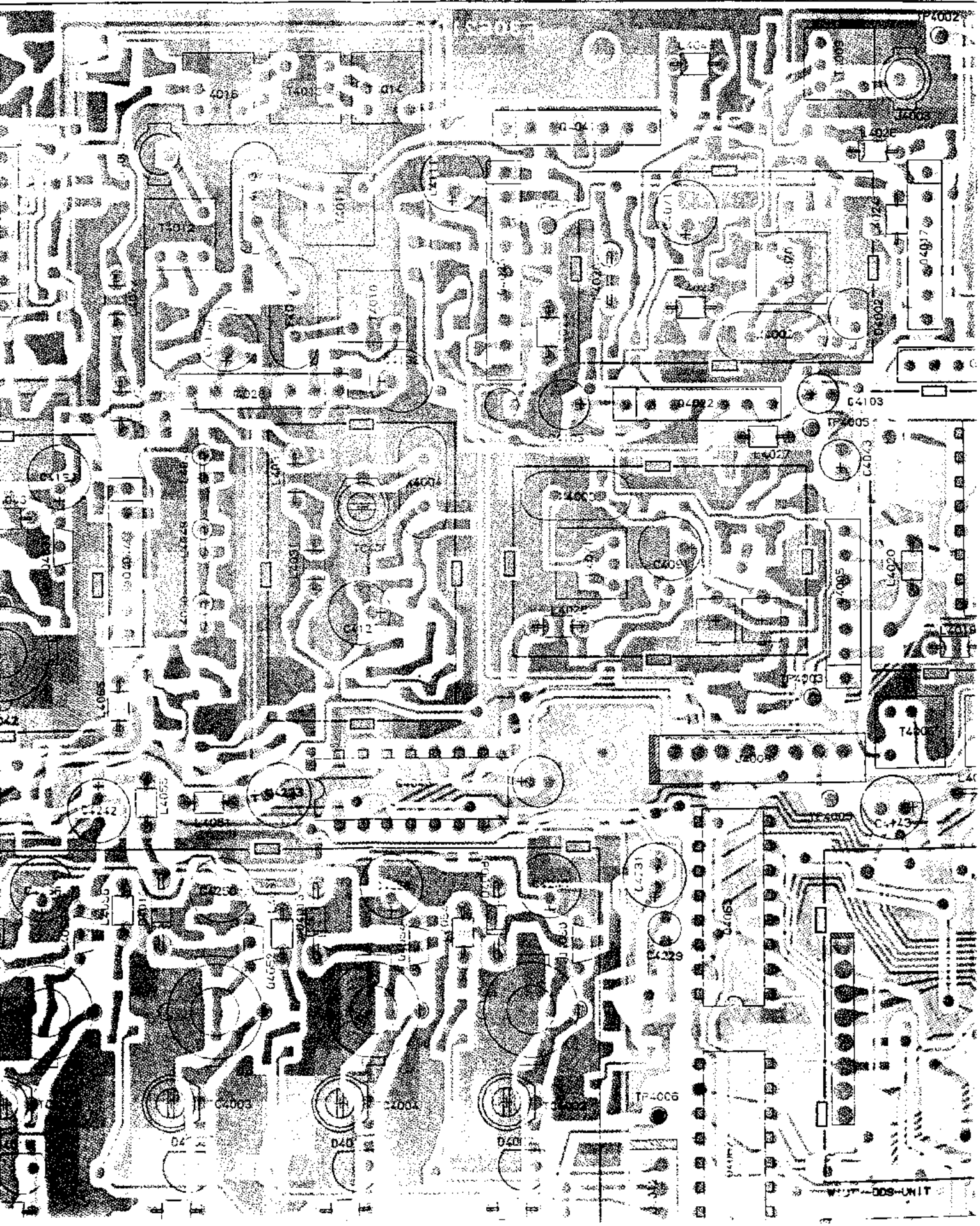

For Service Manuals Contact
MAURITRON TECHNICAL SERVICES
8 Cherry Tree Rd. Chinnor
Oxon OX9 4QY
Tel: 01844-351694 Fax: 01844-352554
Email: enquiries@maurtron.co.uk

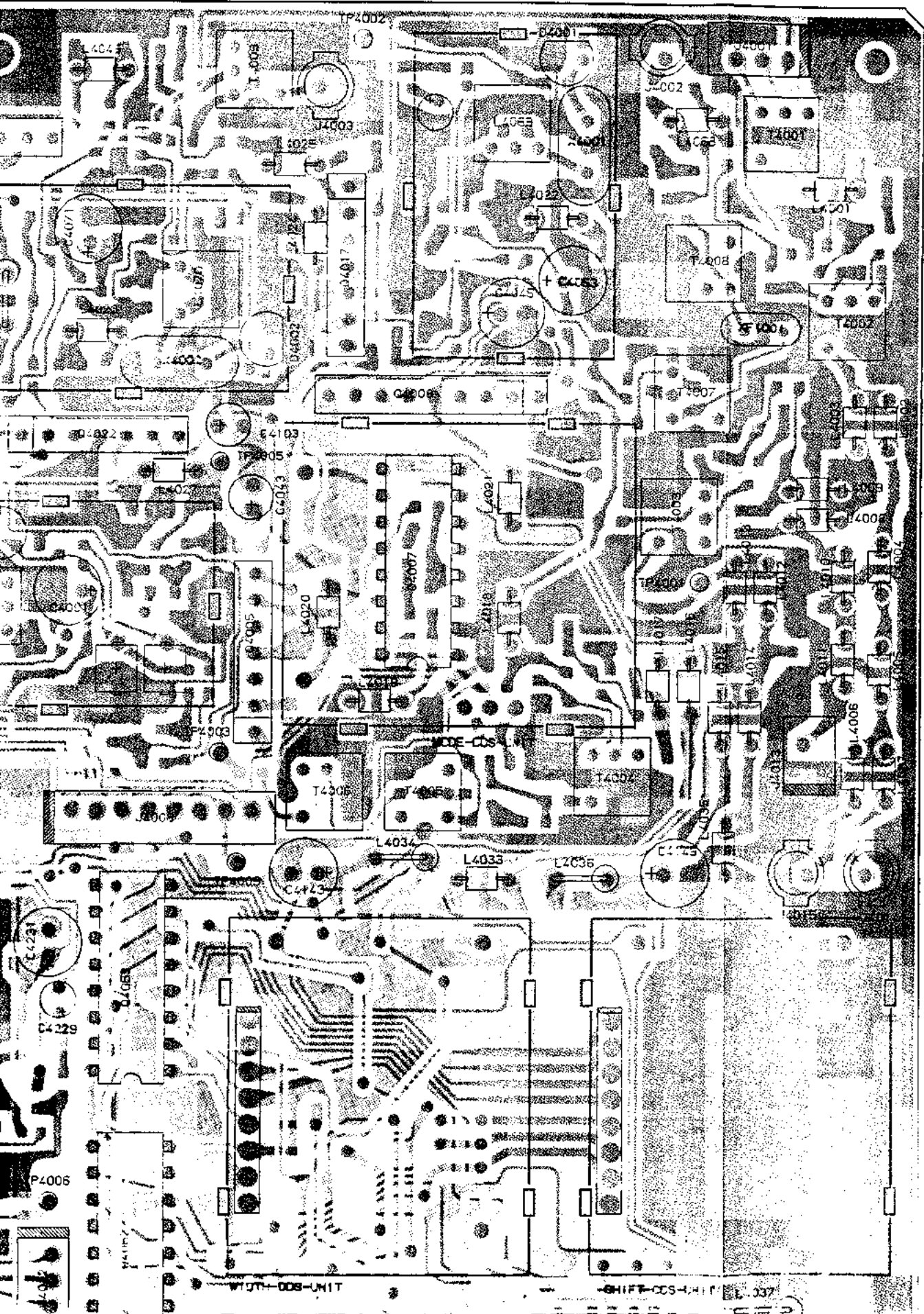

Local Unit Board Layout

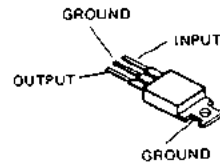
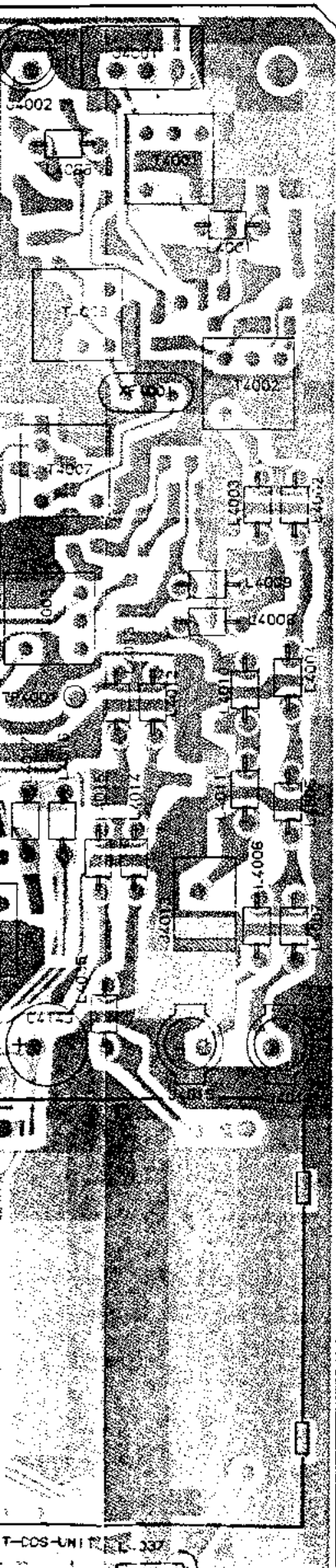

μPC7805H
(Q4013)

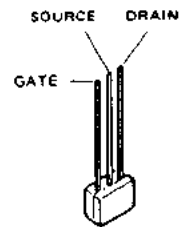

2SK192A-BL
(Q4033)
2SK192AGR
(Q4050, Q4052,
Q4054, Q4058)

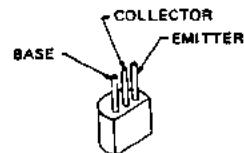

2SC2026
(Q4061)

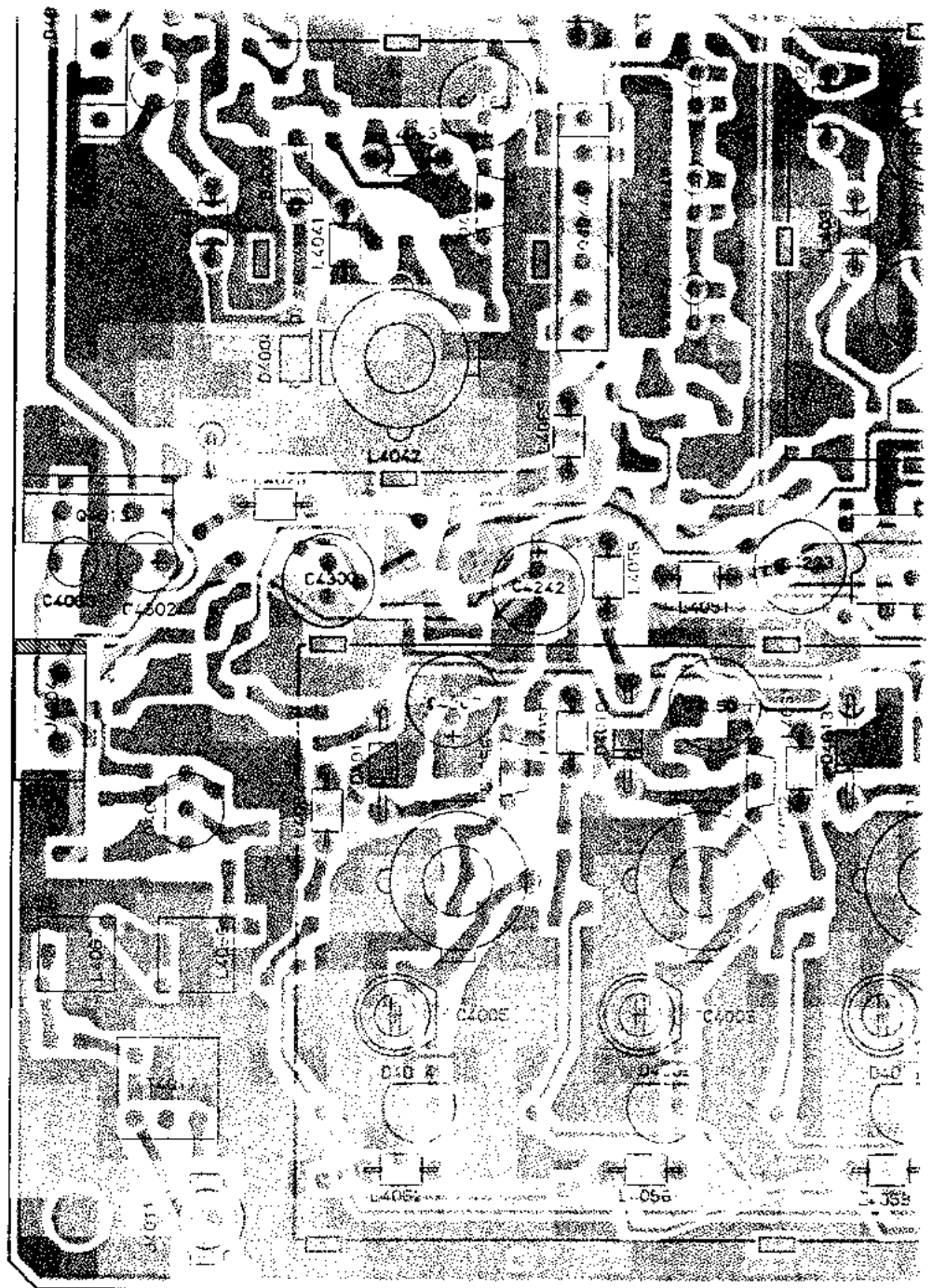

For Service Manuals Contact
MAURITRON TECHNICAL SERVICES
 8 Cherry Tree Rd, Chinnor
 Oxon OX9 4QY
 Tel: 01844-351694 Fax: 01844-352554
 Email: enquiries@mauritron.co.uk

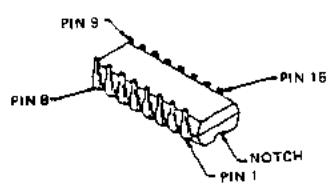

SN74LS390N
 (Q4007)
 MC14008BCP
 (Q4062, Q4063)

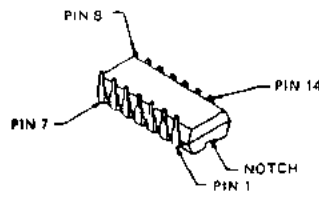
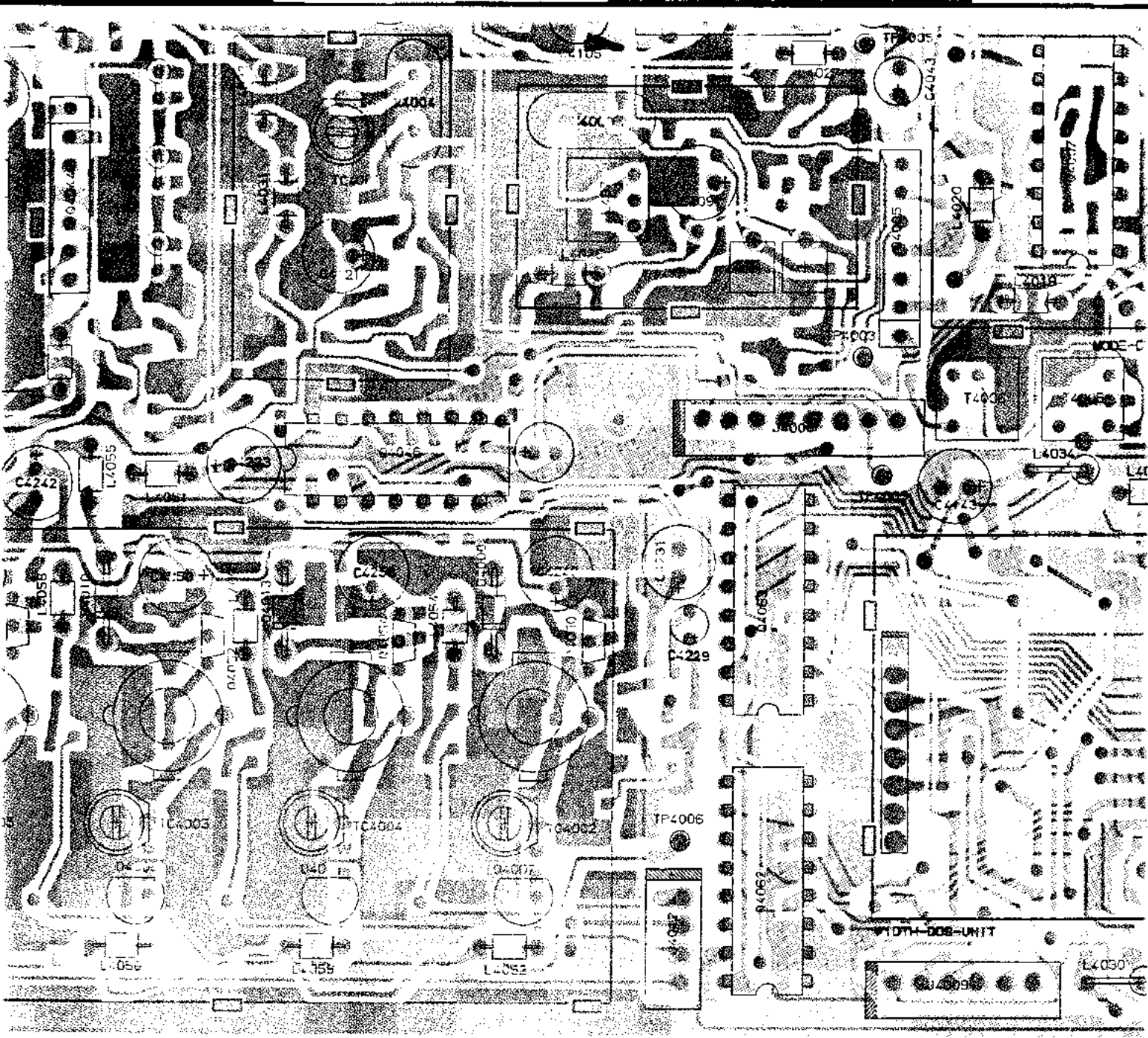

CX-7925B
(04046)

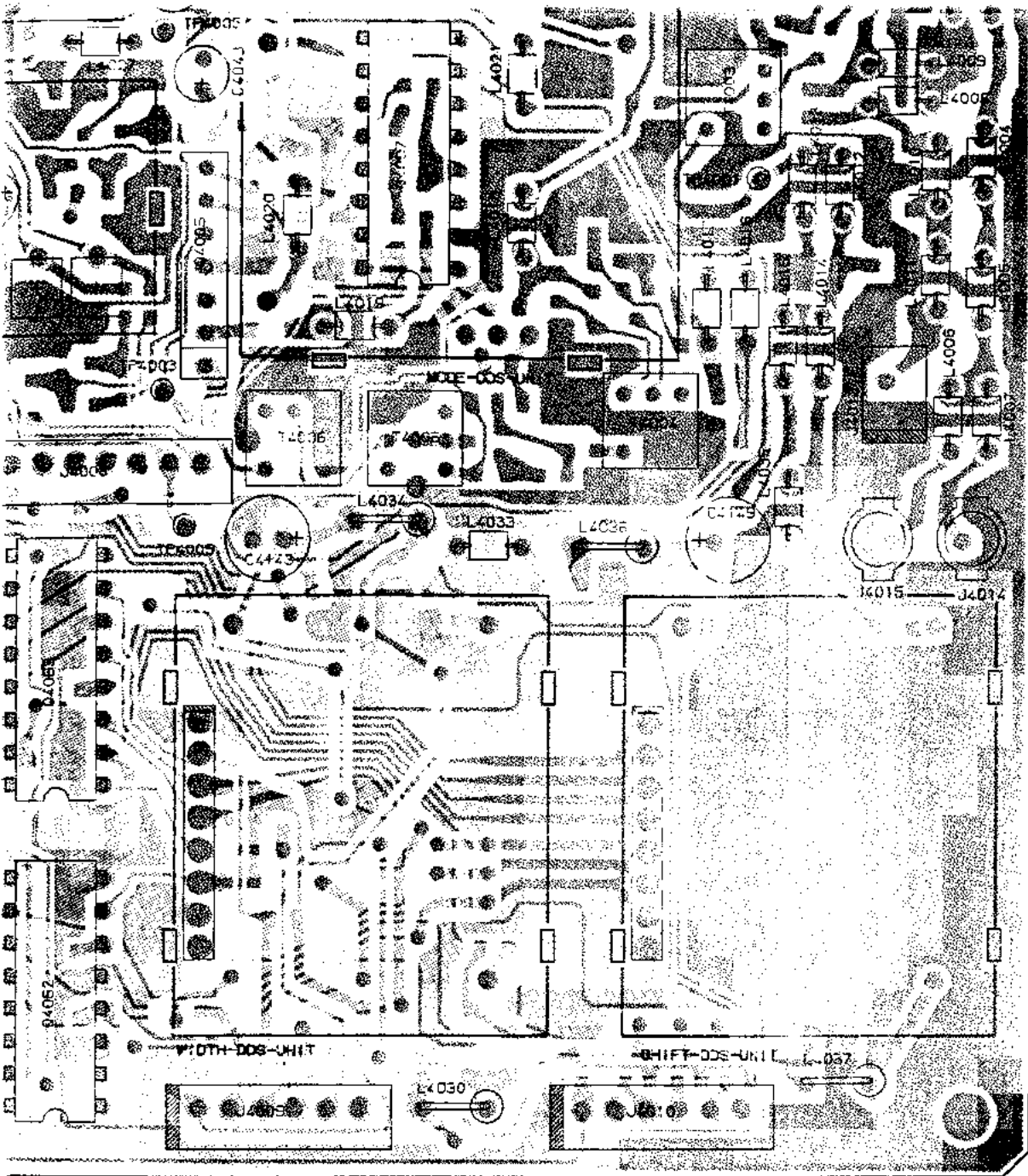

(obverse view of "component" side)

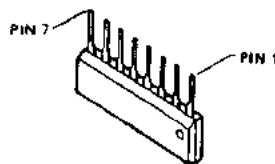

For Service Manuals Contact
MAURITRON TECHNICAL SERVICES
 8 Cherry Tree Rd, Chinnor
 Oxon OX9 4QY
 Tel: 01844-351694 Fax: 01844-352554
 Email: enquiries@mauritron.co.uk

μPC1037H

- (Q4005, Q4017, Q4022,
- Q4028, Q4036, Q4041,
- Q4044

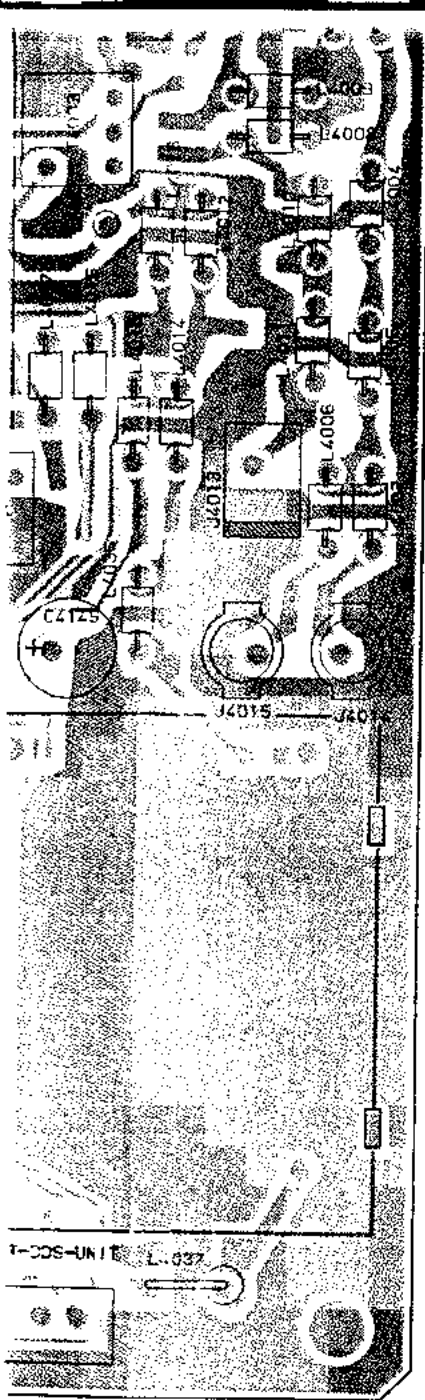

of "component" side)

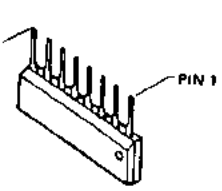

37H
 005, 04017, 04022,
 028, 04036, 04041,
 044

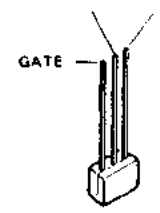

2SK192A-BL
 (Q4033)
 2SK192AGR
 (Q4050, Q4052,
 Q4054, Q4056)

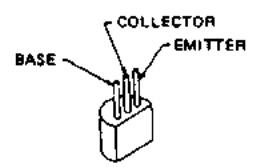

2SC2026
 (Q4061)

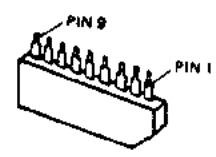

TC5081AP
 (Q4008, Q4023,
 Q4032)

For Service Manuals Contact
MAURITRON TECHNICAL SERVICES
 8 Cherry Tree Rd. Chinnor
 Oxon OX9 4QY
 Tel: 01844-351634 Fax: 01844-352554
 Email: enquiries@mauritron.co.uk

For Service Manuals Contact
MAURITRON TECHNICAL SERVICES
8 Charry Tree Rd, Chinnor
Oxon OX9 4QY
Tel: 01844-351694 Fax: 01844-352554
Email: enquiries@mauritron.co.uk

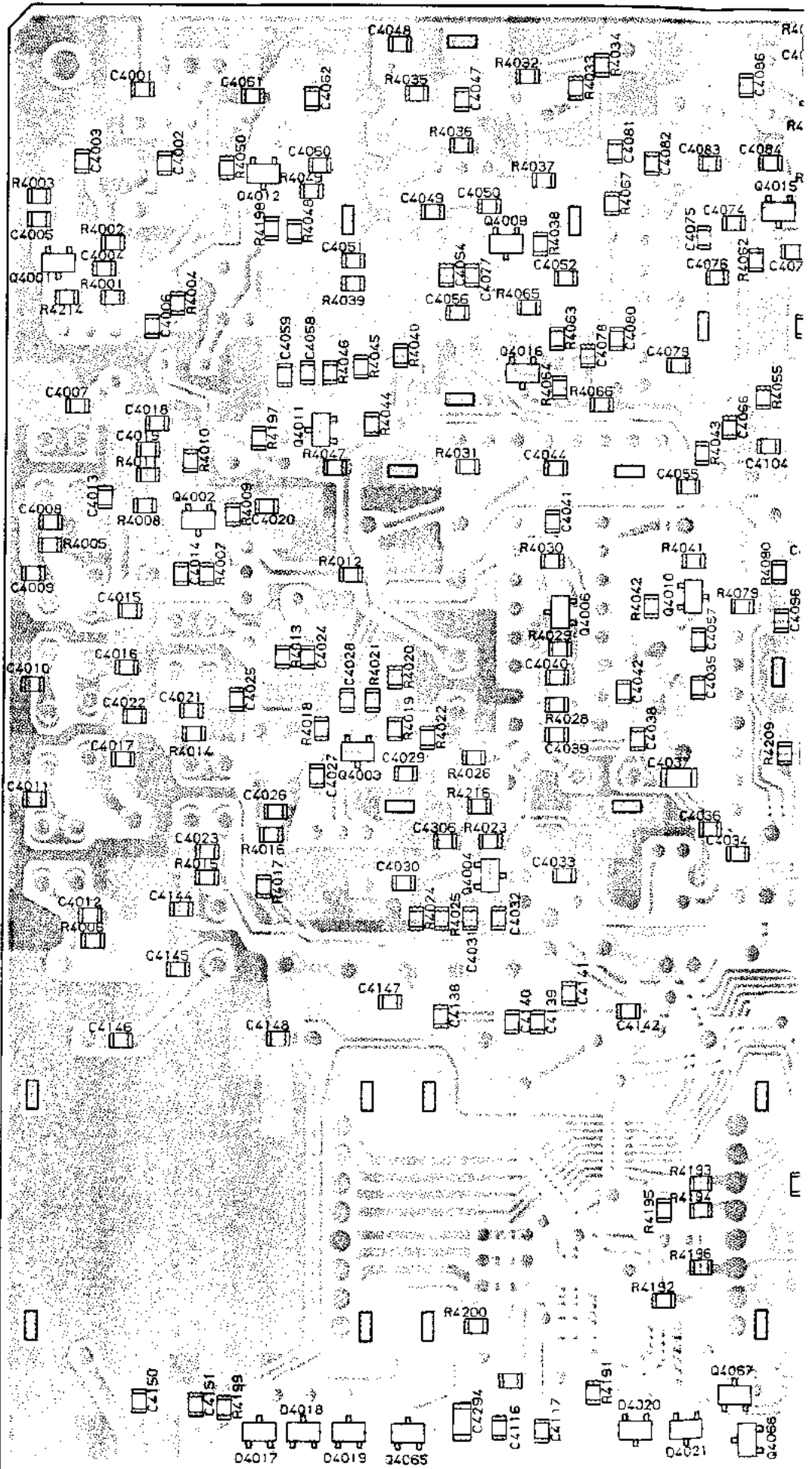

For Service Manuals Contact
MAURITRON TECHNICAL SERVICES
8 Cherry Tree Rd, Chingford
Oxon OX9 4QY
Tel: 01844-351694 Fax: 01844-352554
Email: enquiries@mauritron.co.uk

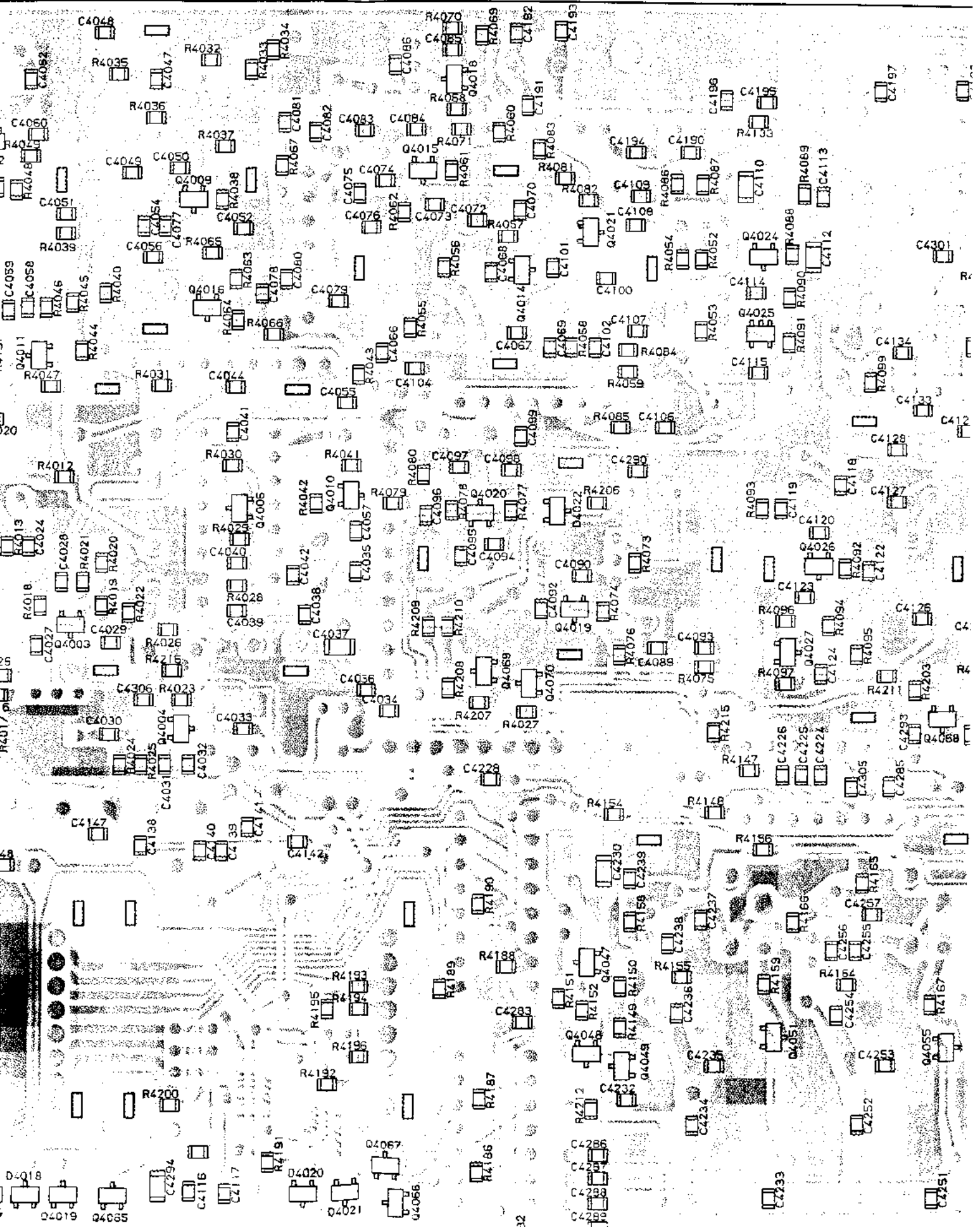

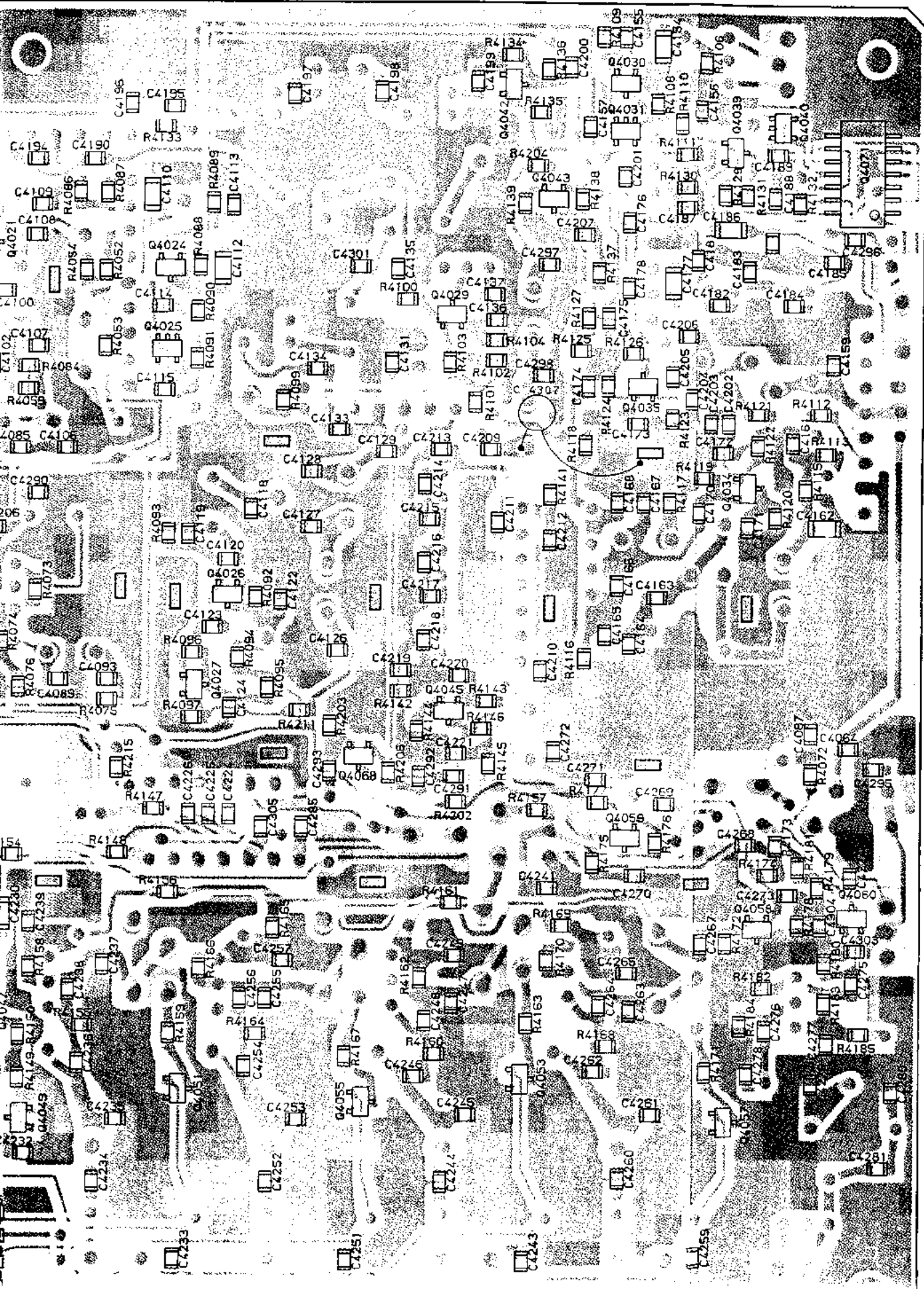

Local Unit Board Layout

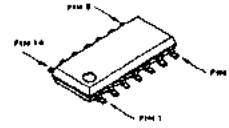
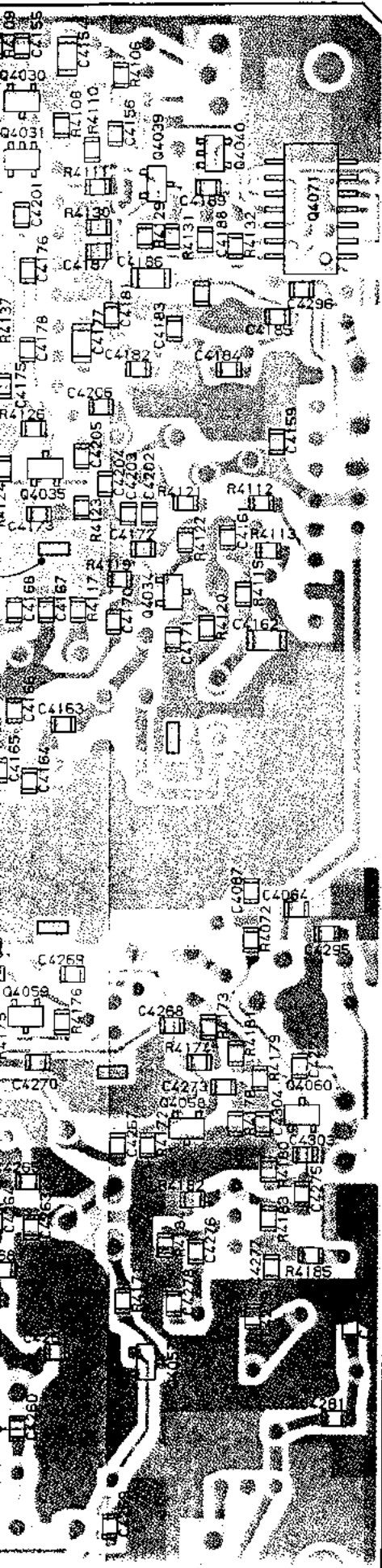

MC14013BFL
(Q4071)

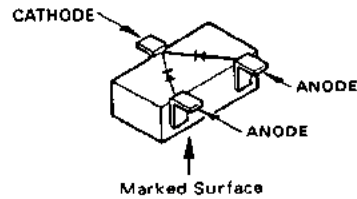

1SS184 (B3)
(D4017, D4018, D4019,
D4020, D4021)

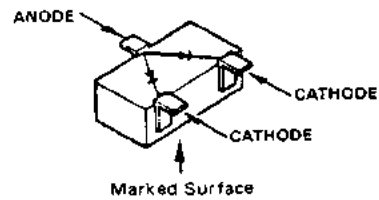

1SS181 (A3)
(D4022)

For Service Manuals Contact
MAURITRON TECHNICAL SERVICES
8 Cherry Tree Rd, Chinnor
Oxon OX9 4QY
Tel: 01844-351694 Fax: 01844-352554
Email: enquiries@mauritron.co.uk

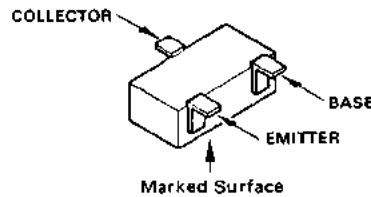

FA1A4M (L33)
(Q4051, Q4053, Q4055,
Q4057, Q4065, Q4066,
Q4067, Q4069, Q4070)

2SC2619FBTR (FB)
(Q4001, Q4002, Q4016,
Q4021, Q4027, Q4043)

2SC2620 (QB)
(Q4003, Q4004, Q4009,)

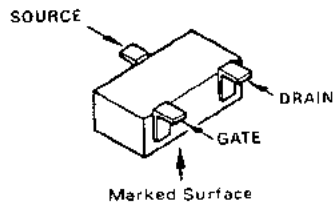
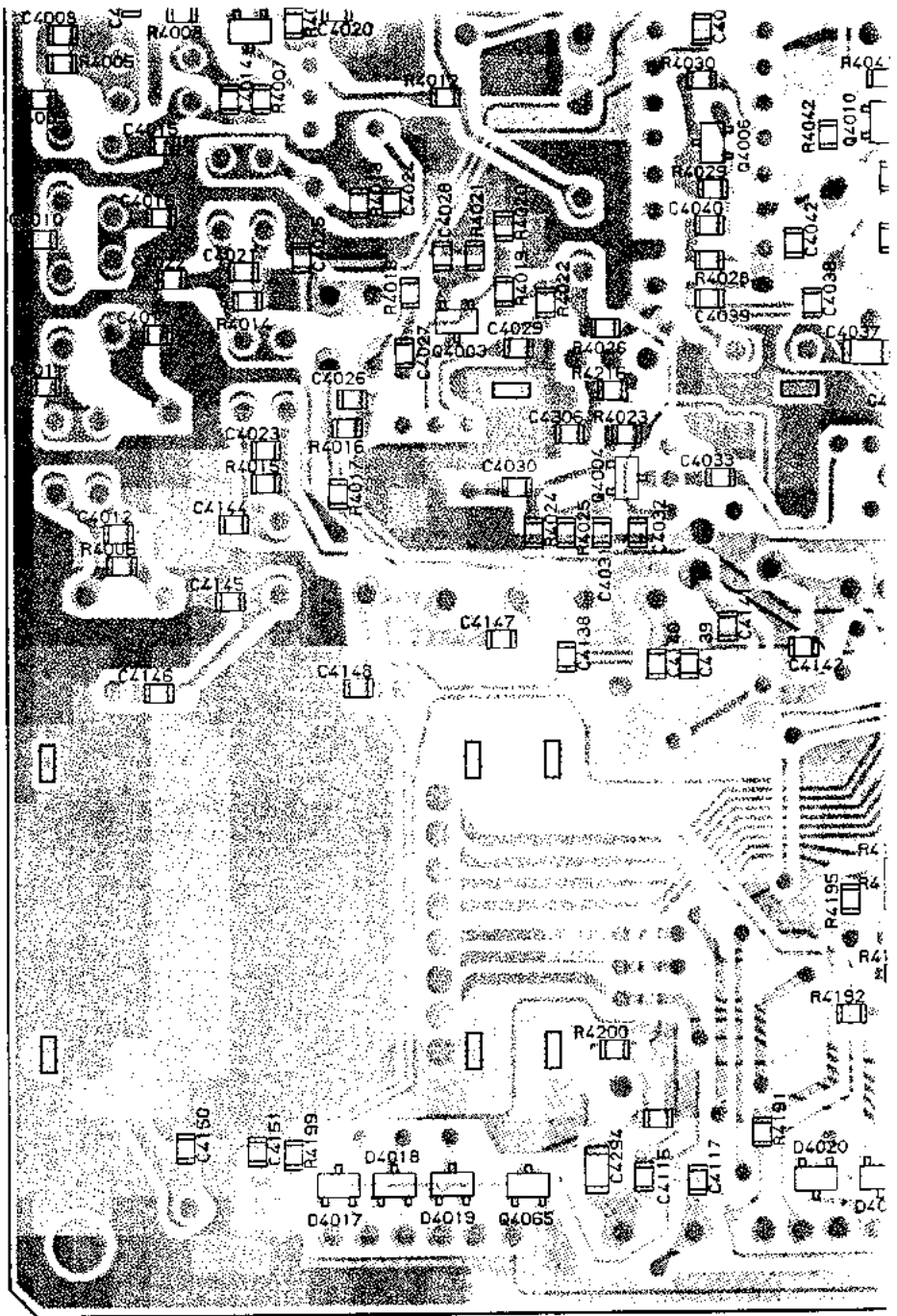

2SK302Y (TY)
 (Q4012, Q4034, Q4058)

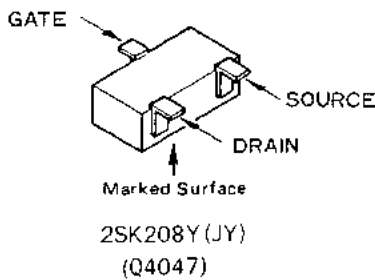
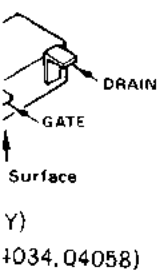
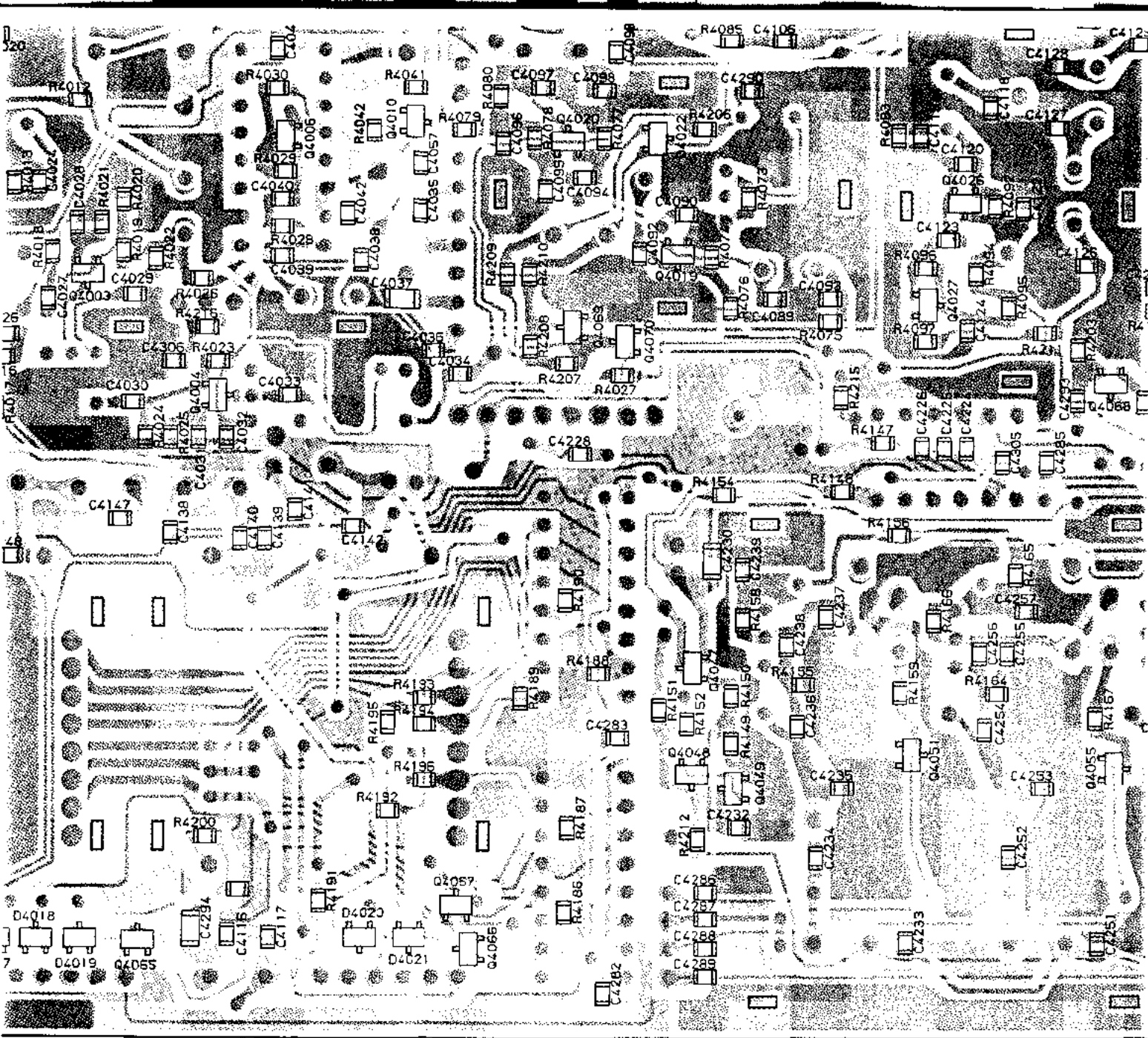

For Service Manuals Contact
MAURITRON TECHNICAL SERVICES
 8 Cherry Tree Rd. Chinnor
 Oxon OX9 4QY
 Tel: 01844-351694 Fax: 01844-352554
 Email: enquiries@mauritron.co.uk

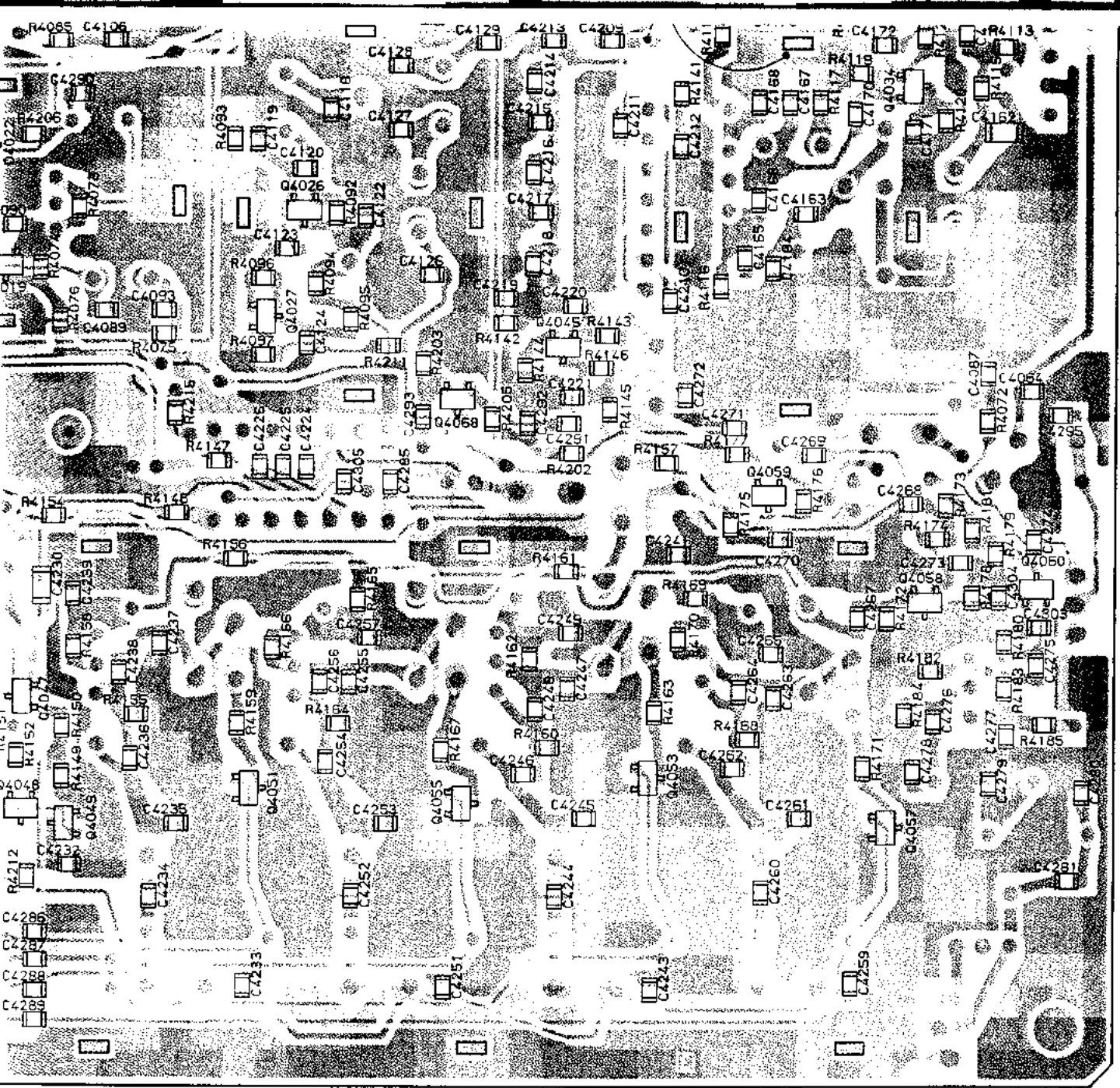

(obverse view of "chip-only" side)

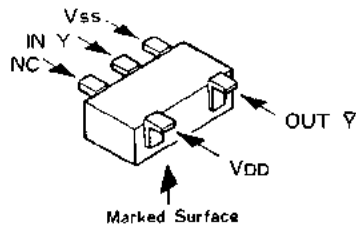
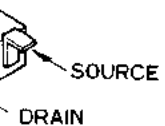

TC4S584F (CA)
(04025, 04031, 04040)

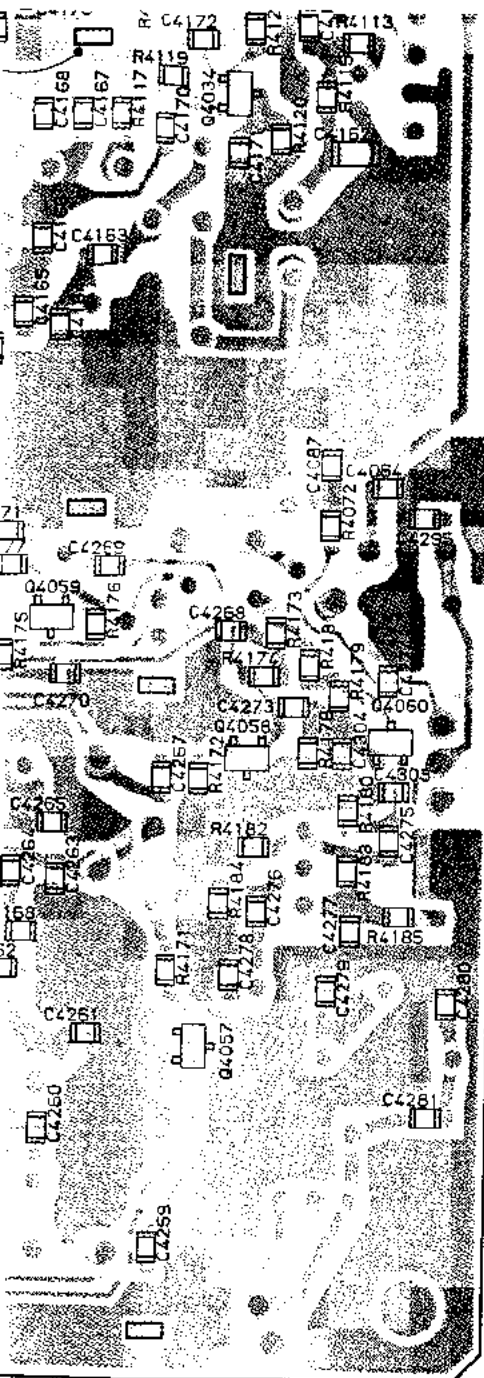

view of "chip-only" side)

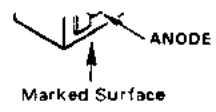
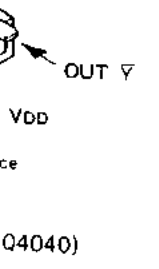

1SS184 (B3)
(D4017, D4018, D4019,
D4020, D4021)

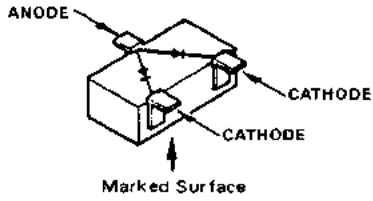

1SS181 (A3)
(D4022)

For Service Manuals Contact
MAURITRON TECHNICAL SERVICES
8 Cherry Tree Rd, Chinnor
Oxon OX: 4QY
Tel: 01844-351694 Fax: 01844-352554
Email: enquiries@maurtron.co.uk

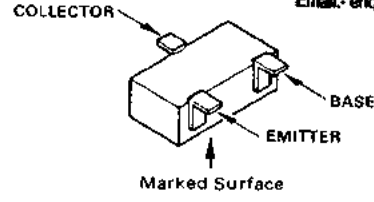

FA1A4M (L33)
(Q4051, Q4053, Q4055,
Q4057, Q4065, Q4066,
Q4067, Q4069, Q4070)

2SC2619FBTR (FB)
(Q4001, Q4002, Q4016,
Q4021, Q4027, Q4043)

2SC2620 (QB)
(Q4003, Q4004, Q4009,
Q4010, Q4011, Q4014,
Q4015, Q4018, Q4019,
Q4020, Q4026, Q4029,
Q4035, Q4042, Q4045)

2SC2714Y (QY)
(Q4059, Q4060, Q4068)

2SC2712GR (LG)
(Q4006, Q4024, Q4030,
Q4039, Q4048, Q4049)

For Service Manuals Contact
MAURITRON TECHNICAL SERVICES
 8 Cherry Tree Rd, Chinnor
 Oxon OX9 4QY
 Tel: 01844-351694 Fax: 01844-352554
 Email: enquires@mauritron.co.uk

LOCAL-UNIT
 F3062101B

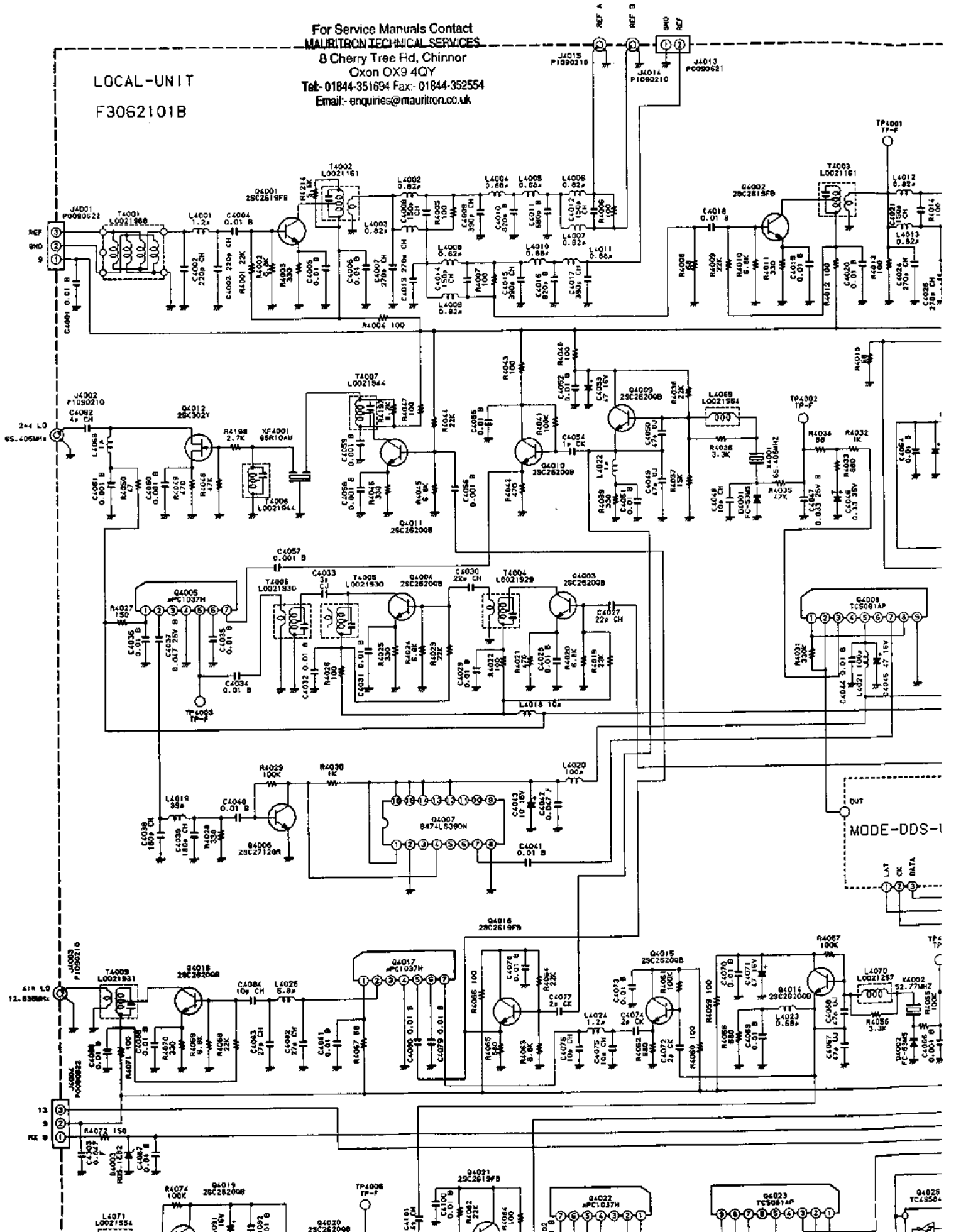

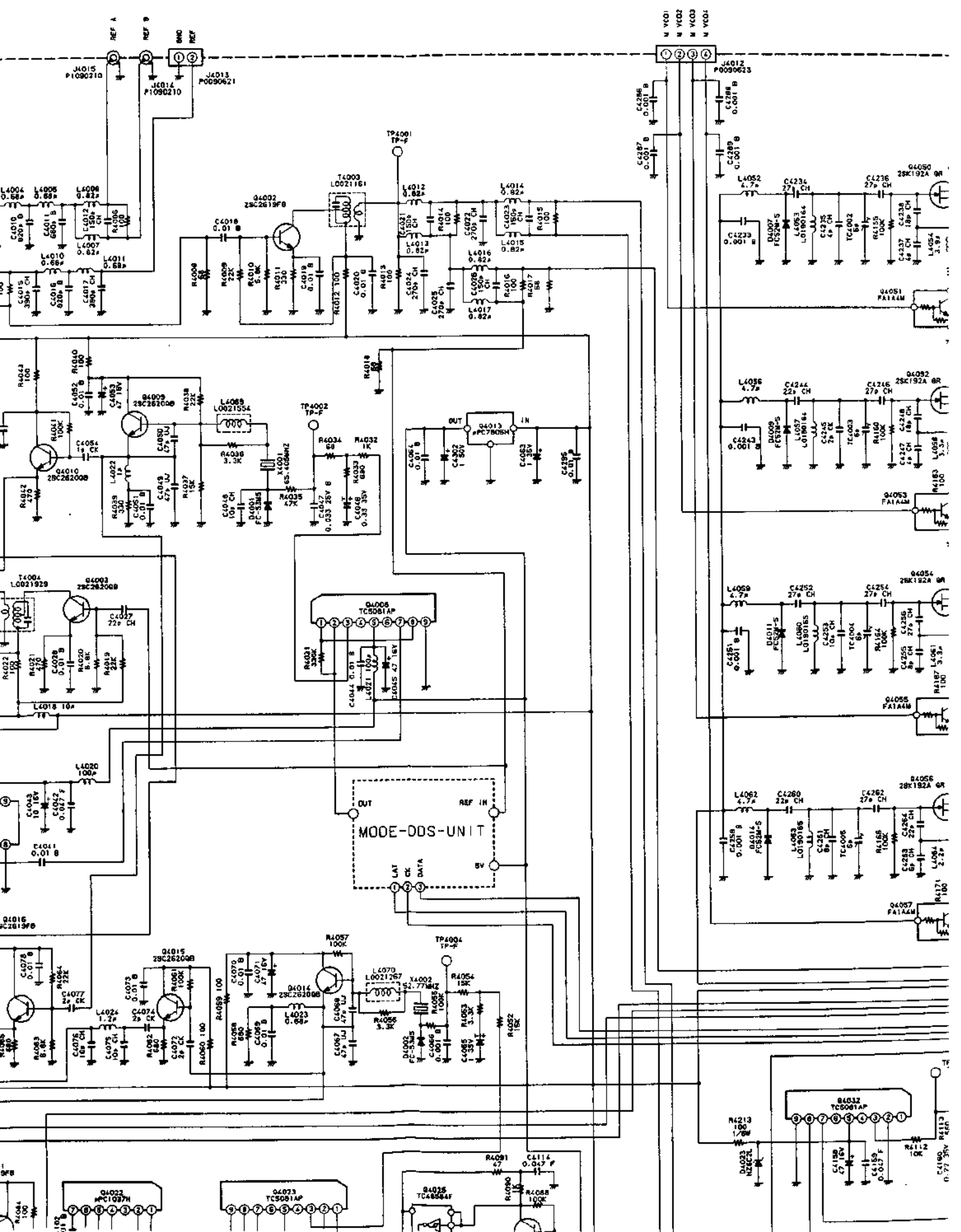

For Service Manuals Contact
MAURITRON TECHNICAL SERVICES
 8 Cherry Tree Rd, Chinnor
 Oxon OX9 4QY
 Tel: 01844 351694 Fax: 01844 352554
 Email: enquiries@mauritron.co.uk

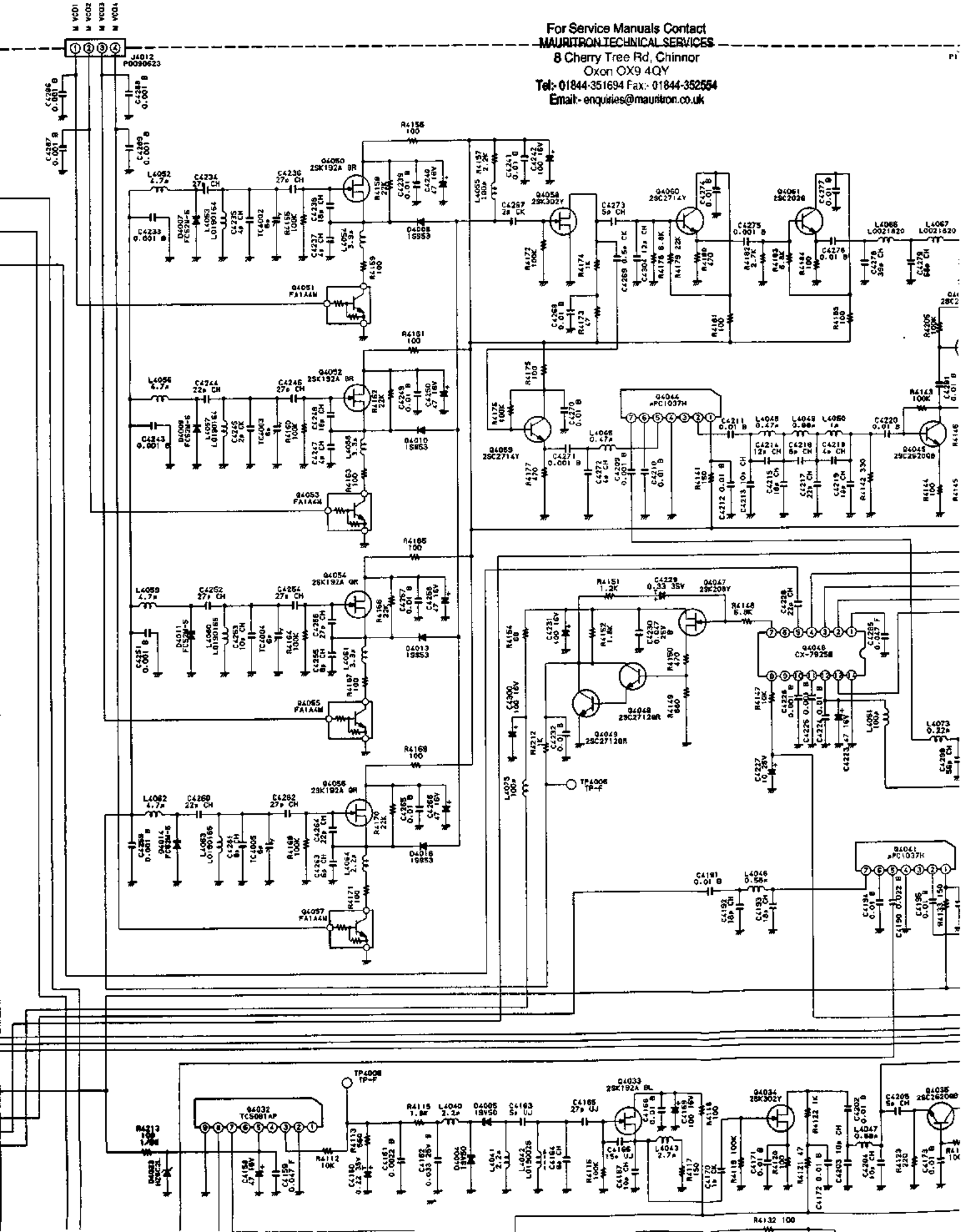

Local Unit Schematic Diagram

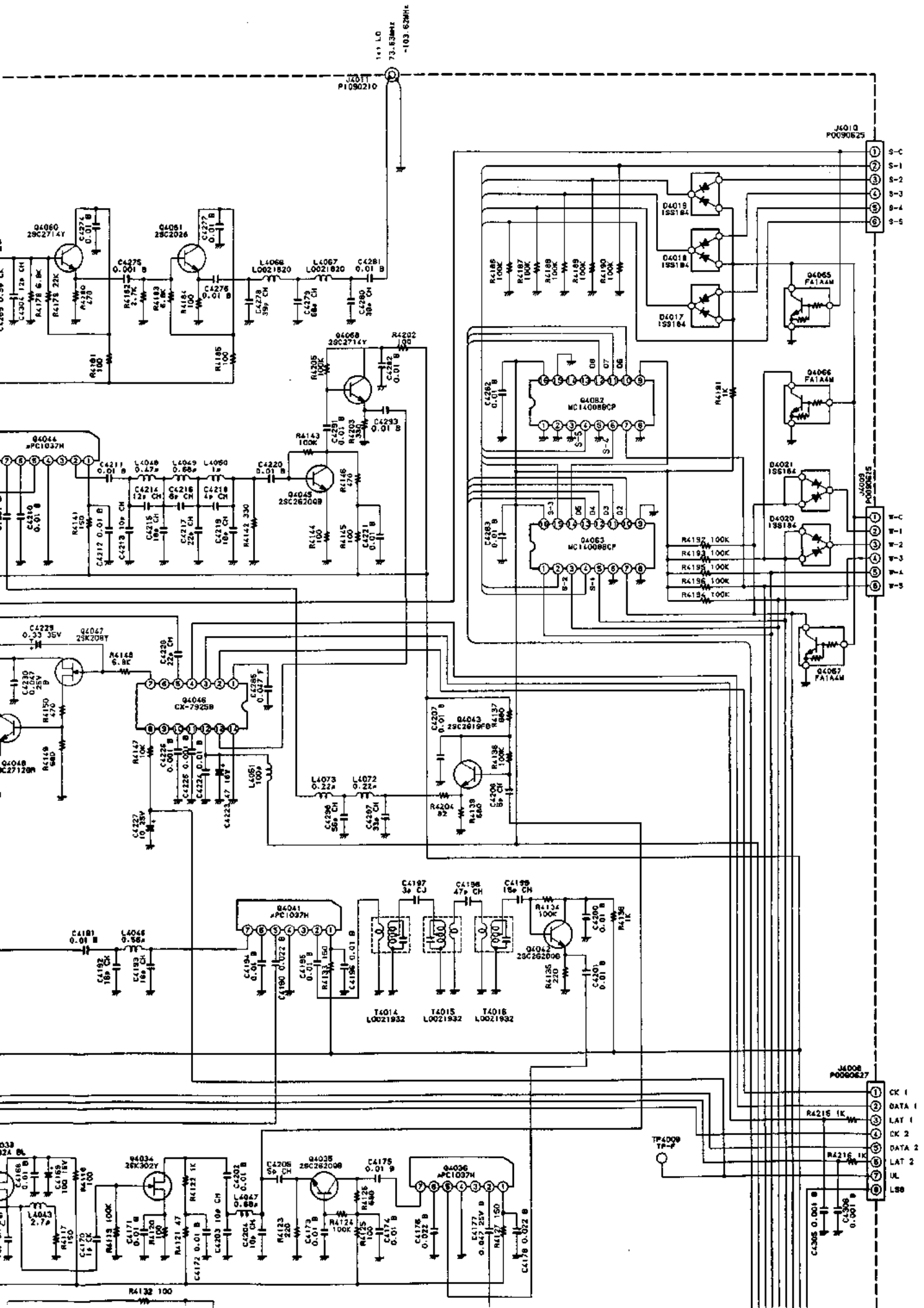

For Service Manuals Contact
MAURITRON TECHNICAL SERVICES
 8 Cherry Tree Rd, Chinnor
 Oxon OX9 4QY
 Tel: 01844-351694 Fax: 01844-352554
 Email: enquiries@mauritron.co.uk

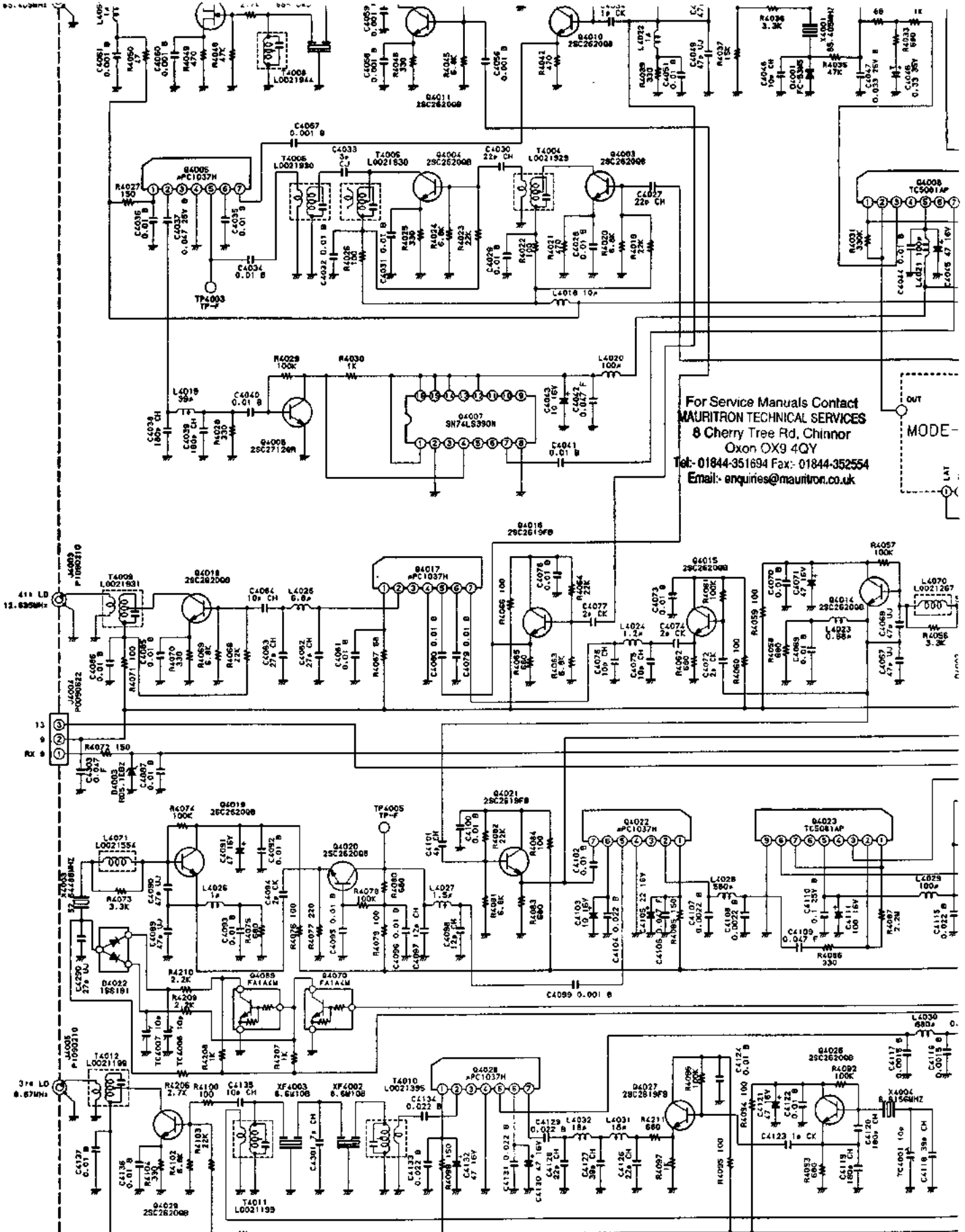

NOTE:
 RESISTOR VALUES ARE IN Ω , 1/10W
 CAPACITOR VALUES ARE IN μ F, 50V
 ELECTROLYTIC CAPACITORS VALUES ARE IN μ F
 (T) CAPACITORS ARE TANTALUM
 INDUCTOR VALUES ARE IN MH
 UNLESS OTHERWISE NOTED.

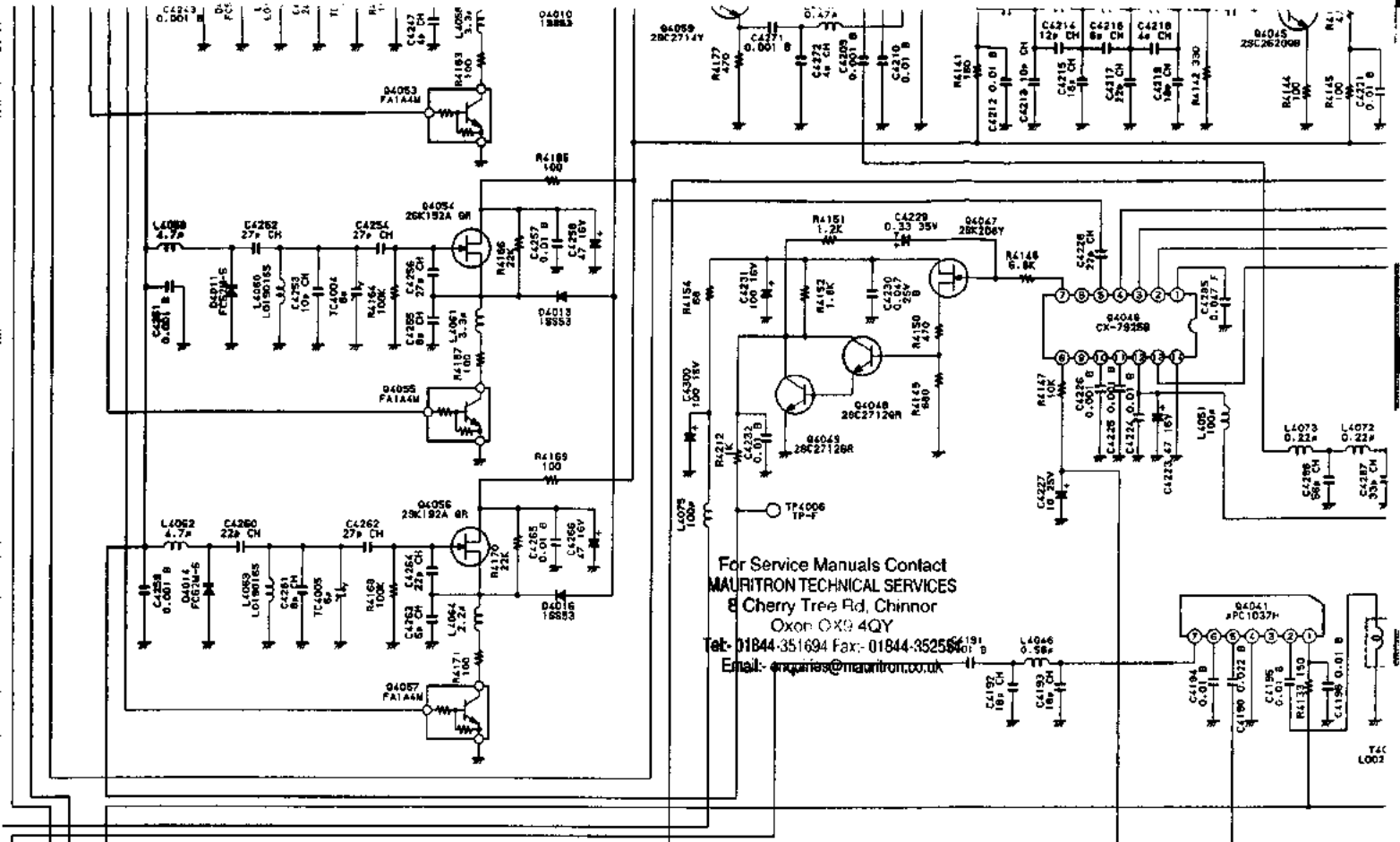

For Service Manuals Contact
MAURITRON TECHNICAL SERVICES
 8 Cherry Tree Rd, Chinnor
 Oxon OX9 4QY
 Tel: 01844-351694 Fax: 01844-352556
 Email: enquiries@mauritron.co.uk

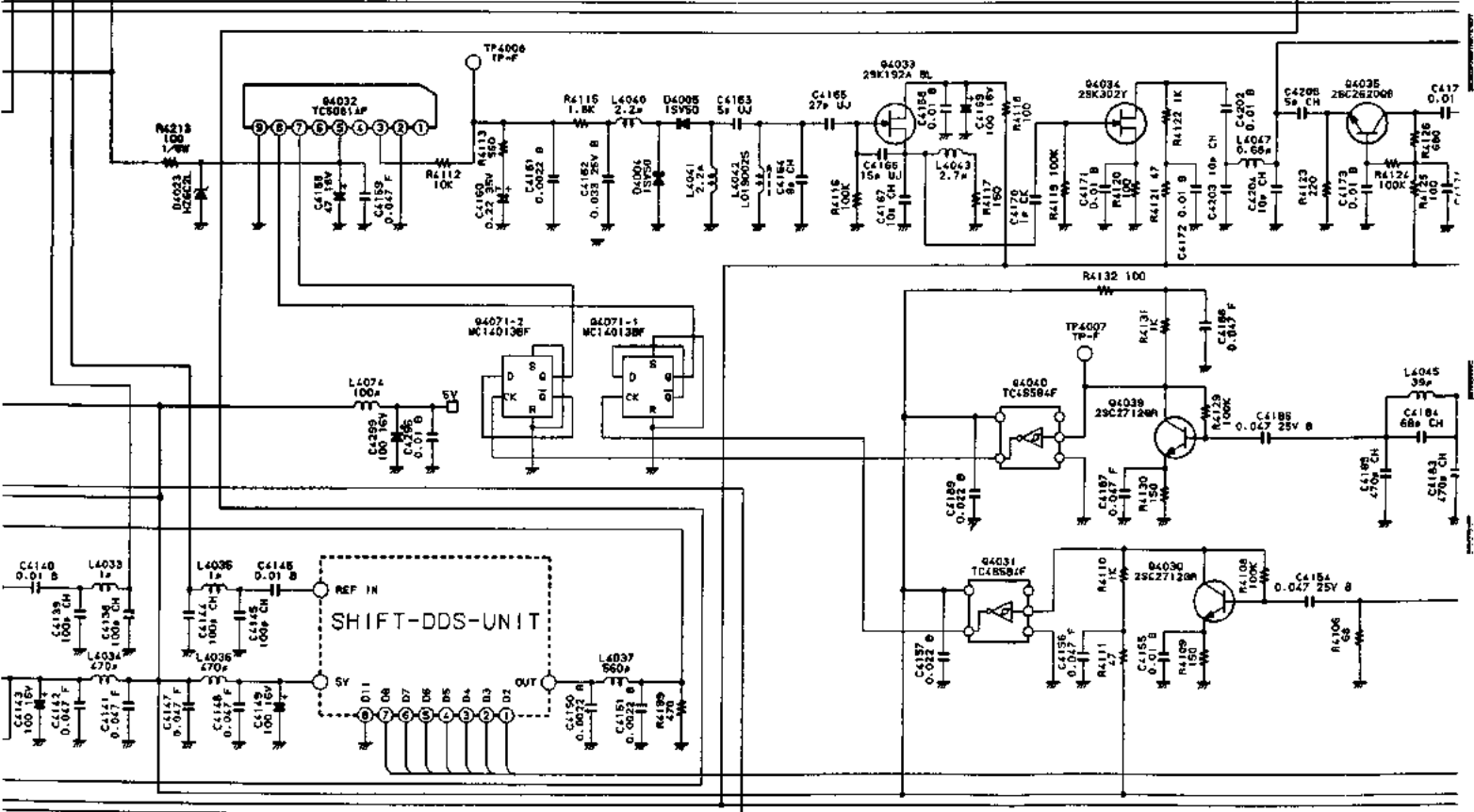

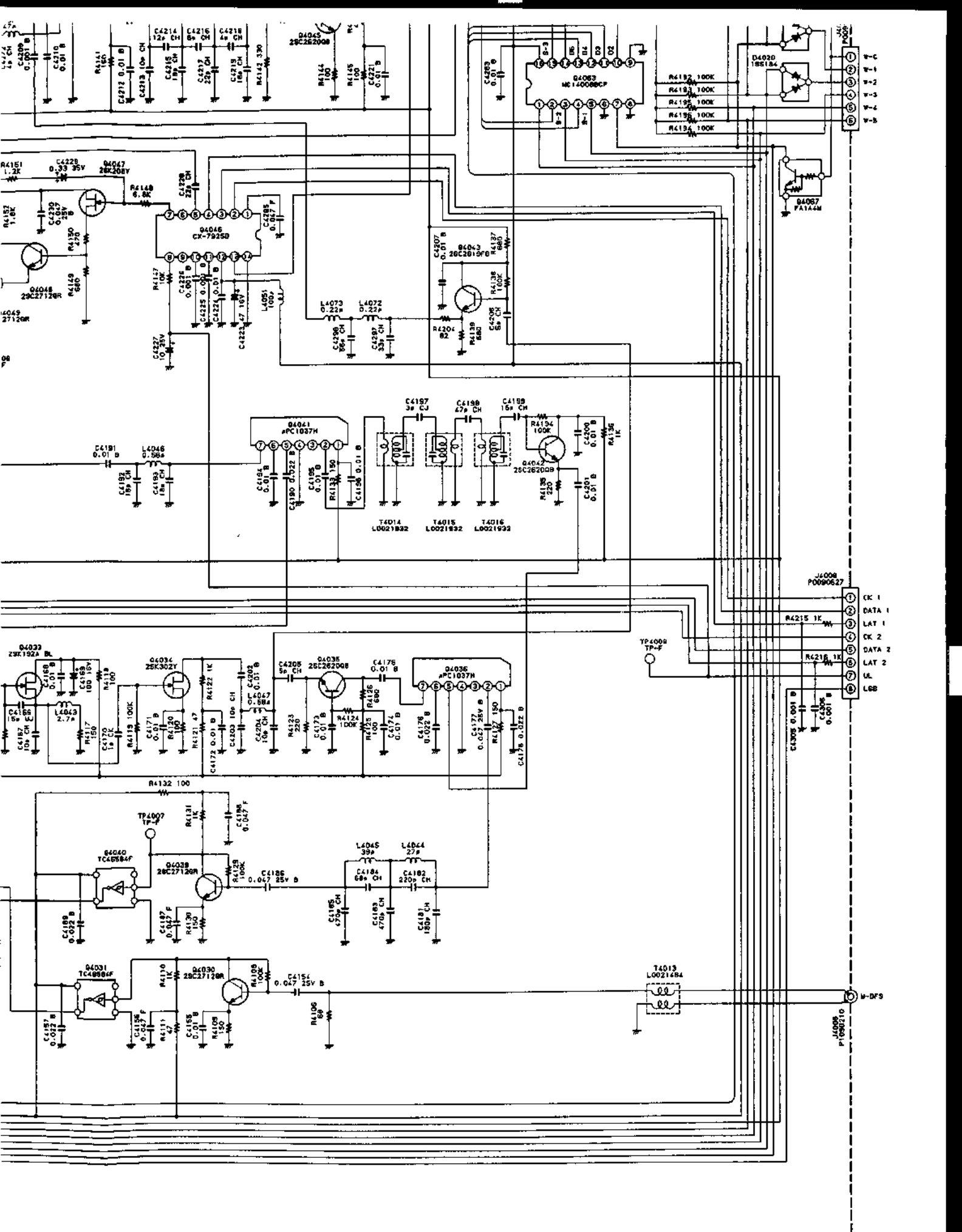

LOCAL UNIT SCHEMATIC DIAGRAM

Control Unit Parts List

ADD	CODE NO	DESCRIPTION	DEVICE			TYP	VAL
** UNIT NAME : CNTL-UNIT							
C 5001	K22141005	CHIP CAP.	GRM40F104Z25PT	0.1uF	25V	F	
C 5002	K22171004	CHIP CAP.	GRM40F103Z50PT	0.01uF	50V	F	
C 5003	K22171004	CHIP CAP.	GRM40F103Z50PT	0.01uF	50V	F	
C 5004	K78120016	TANTALUM CHIP CAP.	TEMSVB21C475M-8R	4.7uF	16V		
C 5005	K78120016	TANTALUM CHIP CAP.	TEMSVB21C475M-8R	4.7uF	16V		
C 5006	K22171004	CHIP CAP.	GRM40F103Z50PT	0.01uF	50V	F	
C 5007	K78120016	TANTALUM CHIP CAP.	TEMSVB21C475M-8R	4.7uF	16V		
C 5008	K22171004	CHIP CAP.	GRM40F103Z50PT	0.01uF	50V	F	
C 5009	K78140013	TANTALUM CHIP CAP.	TEMSVA1E105M-8R	1uF	25V		
C 5010	K22171004	CHIP CAP.	GRM40F103Z50PT	0.01uF	50V	F	
C 5011	K22171004	CHIP CAP.	GRM40F103Z50PT	0.01uF	50V	F	
C 5012	K22171004	CHIP CAP.	GRM40F103Z50PT	0.01uF	50V	F	
C 5013	K22170805	CHIP CAP.	GRM40B102M50PT	0.001uF	50V	B	
C 5014	K22171004	CHIP CAP.	GRM40F103Z50PT	0.01uF	50V	F	
C 5015	K22171004	CHIP CAP.	GRM40F103Z50PT	0.01uF	50V	F	
C 5016	K22171004	CHIP CAP.	GRM40F103Z50PT	0.01uF	50V	F	
C 5017	K22170243	CHIP CAP.	GRM40CH221J50PT	220pF	50V	CH	
C 5018	K22170243	CHIP CAP.	GRM40CH221J50PT	220pF	50V	CH	
C 5019	K22170243	CHIP CAP.	GRM40CH221J50PT	220pF	50V	CH	
C 5020	K22170243	CHIP CAP.	GRM40CH221J50PT	220pF	50V	CH	
C 5021	K22170227	CHIP CAP.	GRM40CH470J50PT	47pF	50V	CH	
C 5022	K22170227	CHIP CAP.	GRM40CH470J50PT	47pF	50V	CH	
C 5024	K22170243	CHIP CAP.	GRM40CH221J50PT	220pF	50V	CH	
C 5025	K22170243	CHIP CAP.	GRM40CH221J50PT	220pF	50V	CH	
C 5026	K22170243	CHIP CAP.	GRM40CH221J50PT	220pF	50V	CH	
C 5027	K22170243	CHIP CAP.	GRM40CH221J50PT	220pF	50V	CH	
C 5028	K22170227	CHIP CAP.	GRM40CH470J50PT	47pF	50V	CH	
C 5029	K22170227	CHIP CAP.	GRM40CH470J50PT	47pF	50V	CH	
C 5030	K22171004	CHIP CAP.	GRM40F103Z50PT	0.01uF	50V	F	
C 5031	K22170243	CHIP CAP.	GRM40CH221J50PT	220pF	50V	CH	
C 5032	K22170243	CHIP CAP.	GRM40CH221J50PT	220pF	50V	CH	
C 5033	K22170243	CHIP CAP.	GRM40CH221J50PT	220pF	50V	CH	
C 5034	K22170243	CHIP CAP.	GRM40CH221J50PT	220pF	50V	CH	
C 5035	K22170227	CHIP CAP.	GRM40CH470J50PT	47pF	50V	CH	
C 5036	K22170227	CHIP CAP.	GRM40CH470J50PT	47pF	50V	CH	
C 5037	K22171004	CHIP CAP.	GRM40F103Z50PT	0.01uF	50V	F	
C 5038	K22171004	CHIP CAP.	GRM40F103Z50PT	0.01uF	50V	F	
C 5039	K22171004	CHIP CAP.	GRM40F103Z50PT	0.01uF	50V	F	
C 5040	K22171004	CHIP CAP.	GRM40F103Z50PT	0.01uF	50V	F	
C 5041	K22171004	CHIP CAP.	GRM40F103Z50PT	0.01uF	50V	F	
C 5042	K22171004	CHIP CAP.	GRM40F103Z50PT	0.01uF	50V	F	
C 5043	K22171004	CHIP CAP.	GRM40F103Z50PT	0.01uF	50V	F	
C 5044	K22171004	CHIP CAP.	GRM40F103Z50PT	0.01uF	50V	F	
C 5045	K22171004	CHIP CAP.	GRM40F103Z50PT	0.01uF	50V	F	
C 5046	K22171004	CHIP CAP.	GRM40F103Z50PT	0.01uF	50V	F	
C 5047	K22171004	CHIP CAP.	GRM40F103Z50PT	0.01uF	50V	F	
C 5048	K22171004	CHIP CAP.	GRM40F103Z50PT	0.01uF	50V	F	
C 5049	K22171004	CHIP CAP.	GRM40F103Z50PT	0.01uF	50V	F	
C 5050	K22171004	CHIP CAP.	GRM40F103Z50PT	0.01uF	50V	F	
C 5051	K22171004	CHIP CAP.	GRM40F103Z50PT	0.01uF	50V	F	
C 5052	K22171004	CHIP CAP.	GRM40F103Z50PT	0.01uF	50V	F	
C 5053	K22171004	CHIP CAP.	GRM40F103Z50PT	0.01uF	50V	F	
C 5054	K22171004	CHIP CAP.	GRM40F103Z50PT	0.01uF	50V	F	
C 5055	K22171004	CHIP CAP.	GRM40F103Z50PT	0.01uF	50V	F	
C 5056	K22171004	CHIP CAP.	GRM40F103Z50PT	0.01uF	50V	F	
C 5057	K22171004	CHIP CAP.	GRM40F103Z50PT	0.01uF	50V	F	
C 5058	K22171004	CHIP CAP.	GRM40F103Z50PT	0.01uF	50V	F	
C 5059	K22171004	CHIP CAP.	GRM40F103Z50PT	0.01uF	50V	F	
C 5060	K22171004	CHIP CAP.	GRM40F103Z50PT	0.01uF	50V	F	
C 5061	K22171004	CHIP CAP.	GRM40F103Z50PT	0.01uF	50V	F	
C 5062	K22171004	CHIP CAP.	GRM40F103Z50PT	0.01uF	50V	F	
C 5063	K22171004	CHIP CAP.	GRM40F103Z50PT	0.01uF	50V	F	
C 5064	K22171004	CHIP CAP.	GRM40F103Z50PT	0.01uF	50V	F	
C 5065	K22171004	CHIP CAP.	GRM40F103Z50PT	0.01uF	50V	F	
C 5066	K22171004	CHIP CAP.	GRM40F103Z50PT	0.01uF	50V	F	
C 5067	K22171004	CHIP CAP.	GRM40F103Z50PT	0.01uF	50V	F	
C 5068	K22171004	CHIP CAP.	GRM40F103Z50PT	0.01uF	50V	F	
C 5069	K22171004	CHIP CAP.	GRM40F103Z50PT	0.01uF	50V	F	
C 5070	K22171004	CHIP CAP.	GRM40F103Z50PT	0.01uF	50V	F	
C 5071	K22171004	CHIP CAP.	GRM40F103Z50PT	0.01uF	50V	F	
C 5072	K22171004	CHIP CAP.	GRM40F103Z50PT	0.01uF	50V	F	
C 5073	K22171004	CHIP CAP.	GRM40F103Z50PT	0.01uF	50V	F	
C 5074	K22171004	CHIP CAP.	GRM40F103Z50PT	0.01uF	50V	F	
C 5075	K22171004	CHIP CAP.	GRM40F103Z50PT	0.01uF	50V	F	
C 5076	K22171004	CHIP CAP.	GRM40F103Z50PT	0.01uF	50V	F	
C 5077	K22171004	CHIP CAP.	GRM40F103Z50PT	0.01uF	50V	F	
C 5078	K22171004	CHIP CAP.	GRM40F103Z50PT	0.01uF	50V	F	
C 5079	K22171004	CHIP CAP.	GRM40F103Z50PT	0.01uF	50V	F	
C 5080	K22171004	CHIP CAP.	GRM40F103Z50PT	0.01uF	50V	F	
C 5081	K22171004	CHIP CAP.	GRM40F103Z50PT	0.01uF	50V	F	
C 5082	K22171004	CHIP CAP.	GRM40F103Z50PT	0.01uF	50V	F	
C 5083	K22171004	CHIP CAP.	GRM40F103Z50PT	0.01uF	50V	F	

Control Unit Parts List

ADD	CODE NO	DESCRIPTION	DEVICE			TYP	VAL
C	5084	K22171004	CHIP CAP.	GRM40F103Z50PT	0.01uF	50V	F
C	5085	K22171004	CHIP CAP.	GRM40F103Z50PT	0.01uF	50V	F
C	5086	K22171004	CHIP CAP.	GRM40F103Z50PT	0.01uF	50V	F
C	5087	K22171004	CHIP CAP.	GRM40F103Z50PT	0.01uF	50V	F
C	5088	K22171004	CHIP CAP.	GRM40F103Z50PT	0.01uF	50V	F
C	5089	K22171004	CHIP CAP.	GRM40F103Z50PT	0.01uF	50V	F
C	5090	K22171004	CHIP CAP.	GRM40F103Z50PT	0.01uF	50V	F
C	5091	K22171004	CHIP CAP.	GRM40F103Z50PT	0.01uF	50V	F
C	5092	K22171004	CHIP CAP.	GRM40F103Z50PT	0.01uF	50V	F
C	5093	K22171004	CHIP CAP.	GRM40F103Z50PT	0.01uF	50V	F
C	5094	K22171004	CHIP CAP.	GRM40F103Z50PT	0.01uF	50V	F
C	5095	K22171004	CHIP CAP.	GRM40F103Z50PT	0.01uF	50V	F
C	5096	K22171004	CHIP CAP.	GRM40F103Z50PT	0.01uF	50V	F
C	5097	K22171004	CHIP CAP.	GRM40F103Z50PT	0.01uF	50V	F
C	5098	K22171004	CHIP CAP.	GRM40F103Z50PT	0.01uF	50V	F
C	5099	K22171004	CHIP CAP.	GRM40F103Z50PT	0.01uF	50V	F
C	5100	K22171004	CHIP CAP.	GRM40F103Z50PT	0.01uF	50V	F
C	5101	K22171004	CHIP CAP.	GRM40F103Z50PT	0.01uF	50V	F
C	5102	K22171004	CHIP CAP.	GRM40F103Z50PT	0.01uF	50V	F
C	5103	K22171004	CHIP CAP.	GRM40F103Z50PT	0.01uF	50V	F
C	5104	K22171004	CHIP CAP.	GRM40F103Z50PT	0.01uF	50V	F
C	5105	K22171004	CHIP CAP.	GRM40F103Z50PT	0.01uF	50V	F
C	5106	K22171004	CHIP CAP.	GRM40F103Z50PT	0.01uF	50V	F
C	5107	K22171004	CHIP CAP.	GRM40F103Z50PT	0.01uF	50V	F
C	5108	K22171004	CHIP CAP.	GRM40F103Z50PT	0.01uF	50V	F
C	5109	K22171004	CHIP CAP.	GRM40F103Z50PT	0.01uF	50V	F
C	5110	K22171004	CHIP CAP.	GRM40F103Z50PT	0.01uF	50V	F
C	5111	K22171004	CHIP CAP.	GRM40F103Z50PT	0.01uF	50V	F
C	5112	K22171004	CHIP CAP.	GRM40F103Z50PT	0.01uF	50V	F
C	5113	K22171004	CHIP CAP.	GRM40F103Z50PT	0.01uF	50V	F
C	5114	K22171004	CHIP CAP.	GRM40F103Z50PT	0.01uF	50V	F
C	5115	K22171004	CHIP CAP.	GRM40F103Z50PT	0.01uF	50V	F
C	5116	K22171004	CHIP CAP.	GRM40F103Z50PT	0.01uF	50V	F
C	5117	K22171004	CHIP CAP.	GRM40F103Z50PT	0.01uF	50V	F
C	5118	K22171004	CHIP CAP.	GRM40F103Z50PT	0.01uF	50V	F
C	5119	K22171004	CHIP CAP.	GRM40F103Z50PT	0.01uF	50V	F
C	5120	K22171004	CHIP CAP.	GRM40F103Z50PT	0.01uF	50V	F
C	5121	K22171004	CHIP CAP.	GRM40F103Z50PT	0.01uF	50V	F
C	5122	K22171004	CHIP CAP.	GRM40F103Z50PT	0.01uF	50V	F
C	5123	K22171004	CHIP CAP.	GRM40F103Z50PT	0.01uF	50V	F
C	5124	K22171004	CHIP CAP.	GRM40F103Z50PT	0.01uF	50V	F
C	5125	K22171004	CHIP CAP.	GRM40F103Z50PT	0.01uF	50V	F
C	5126	K22171004	CHIP CAP.	GRM40F103Z50PT	0.01uF	50V	F
C	5127	K22171004	CHIP CAP.	GRM40F103Z50PT	0.01uF	50V	F
C	5128	K22171004	CHIP CAP.	GRM40F103Z50PT	0.01uF	50V	F
C	5129	K22171004	CHIP CAP.	GRM40F103Z50PT	0.01uF	50V	F
C	5130	K22171004	CHIP CAP.	GRM40F103Z50PT	0.01uF	50V	F
C	5131	K22171004	CHIP CAP.	GRM40F103Z50PT	0.01uF	50V	F
C	5132	K22171004	CHIP CAP.	GRM40F103Z50PT	0.01uF	50V	F
C	5133	K22171004	CHIP CAP.	GRM40F103Z50PT	0.01uF	50V	F
C	5134	K22171004	CHIP CAP.	GRM40F103Z50PT	0.01uF	50V	F
C	5135	K22171004	CHIP CAP.	GRM40F103Z50PT	0.01uF	50V	F
C	5136	K22171004	CHIP CAP.	GRM40F103Z50PT	0.01uF	50V	F
C	5137	K22171004	CHIP CAP.	GRM40F103Z50PT	0.01uF	50V	F
C	5138	K22171004	CHIP CAP.	GRM40F103Z50PT	0.01uF	50V	F
C	5139	K22171004	CHIP CAP.	GRM40F103Z50PT	0.01uF	50V	F
C	5140	K22171004	CHIP CAP.	GRM40F103Z50PT	0.01uF	50V	F
C	5141	K22171004	CHIP CAP.	GRM40F103Z50PT	0.01uF	50V	F
C	5142	K22171004	CHIP CAP.	GRM40F103Z50PT	0.01uF	50V	F
C	5143	K22171004	CHIP CAP.	GRM40F103Z50PT	0.01uF	50V	F
C	5144	K22171004	CHIP CAP.	GRM40F103Z50PT	0.01uF	50V	F
C	5145	K22171004	CHIP CAP.	GRM40F103Z50PT	0.01uF	50V	F
C	5146	K22171004	CHIP CAP.	GRM40F103Z50PT	0.01uF	50V	F
C	5147	K22170217	CHIP CAP.	GRM40CH180J50PT	18pF	50V	CH
C	5148	K22170217	CHIP CAP.	GRM40CH180J50PT	18pF	50V	CH
C	5149	K22171004	CHIP CAP.	GRM40F103Z50PT	0.01uF	50V	F
C	5150	K22171004	CHIP CAP.	GRM40F103Z50PT	0.01uF	50V	F
C	5151	K22171004	CHIP CAP.	GRM40F103Z50PT	0.01uF	50V	F
C	5152	K78160027	TANTALUM CHIP CAP.	TESVA1V224M1-8R	0.22uF	35V	F
C	5153	K22171004	CHIP CAP.	GRM40F103Z50PT	0.01uF	50V	F
C	5154	K22170821	CHIP CAP.	GRM40B223M50PT	0.022uF	50V	B
C	5155	K22141809	CHIP CAP.	GRM42-6B104M25PT	0.1uF	25V	B
C	5156	K22171004	CHIP CAP.	GRM40F103Z50PT	0.01uF	50V	F
C	5157	K22171004	CHIP CAP.	GRM40F103Z50PT	0.01uF	50V	F
C	5158	K22171004	CHIP CAP.	GRM40F103Z50PT	0.01uF	50V	F
C	5159	K22171004	CHIP CAP.	GRM40F103Z50PT	0.01uF	50V	F
C	5160	K22171004	CHIP CAP.	GRM40F103Z50PT	0.01uF	50V	F
C	5162	K22171004	CHIP CAP.	GRM40F103Z50PT	0.01uF	50V	F
C	5163	K22171004	CHIP CAP.	GRM40F103Z50PT	0.01uF	50V	F
C	5164	K22171004	CHIP CAP.	GRM40F103Z50PT	0.01uF	50V	F
C	5165	K22171004	CHIP CAP.	GRM40F103Z50PT	0.01uF	50V	F
D	5001	G2070018	DIODE	MC2838-T14-2			
D	5002	G2070018	DIODE	MC2838-T14-2			

For Service Manuals Contact
 MAINTENANCE TECHNICAL SERVICES
 8 Cherry Tree Rd, Chinnor
 Oxon OX9 4DQ
 Tel: 01844-351600 Fax: 01844-352554
 Email: enquiries@mainttron.co.uk

Control Unit Parts List

ADD	CODE NO	DESCRIPTION	DEVICE	TYP VAL
D	5003	G2070018	DIODE	MC2838-T14-2
D	5004	G2070018	DIODE	MC2838-T14-2
D	5008	G2070018	DIODE	MC2838-T14-2
D	5009	G2070018	DIODE	MC2838-T14-2
J	5001	P0090623	CONNECTOR	SC25-04WS
J	5002	P0090626	CONNECTOR	SC25-07WS
J	5003	P0090627	CONNECTOR	SC25-08WS
J	5004	P0090623	CONNECTOR	SC25-04WS
J	5005	P0090624	CONNECTOR	SC25-05WS
J	5006	P0090623	CONNECTOR	SC25-04WS
J	5007	P0090626	CONNECTOR	SC25-07WS
J	5008	P0090623	CONNECTOR	SC25-04WS
J	5009	P0090624	CONNECTOR	SC25-05WS
J	5010	P0090623	CONNECTOR	SC25-04WS
J	5011	P0090621	CONNECTOR	SC25-02WS
J	5012	P0090622	CONNECTOR	SC25-03WS
J	5013	P0090622	CONNECTOR	SC25-03WS
J	5014	P0090624	CONNECTOR	SC25-05WS
J	5015	P0090627	CONNECTOR	SC25-08WS
J	5016	P0090625	CONNECTOR	SC25-06WS
J	5017	P0090622	CONNECTOR	SC25-03WS
J	5018	P0090622	CONNECTOR	SC25-03WS
J	5019	P0090629	CONNECTOR	SC25-10WS
J	5020	P0090627	CONNECTOR	SC25-08WS
J	5021	P0090623	CONNECTOR	SC25-04WS
J	5022	P0090624	CONNECTOR	SC25-05WS
J	5023	P0090624	CONNECTOR	SC25-05WS
J	5024	P0090623	CONNECTOR	SC25-04WS
J	5025	P0090624	CONNECTOR	SC25-05WS
J	5026	P0090631	CONNECTOR	SC25-12WS
J	5027	P0090628	CONNECTOR	SC25-09WS
J	5028	P0090621	CONNECTOR	SC25-02WS
J	5029	P0090621	CONNECTOR	SC25-02WS
J	5030	P0090624	CONNECTOR	SC25-05WS
J	5031	P0090623	CONNECTOR	SC25-04WS
J	5032	P0090623	CONNECTOR	SC25-04WS
J	5033	P0090624	CONNECTOR	SC25-05WS
J	5034	P0090624	CONNECTOR	SC25-05WS
Q	5001	G1091009	IC	HD64180R1F8
Q	5002	G1091013	IC	LH5164L-15
Q	5003	G1091070	IC	TC67256AD-15
Q	5004	G1090993	IC	M5M82C55AFP-2D7
Q	5005	G1090993	IC	M5M82C55AFP-2D7
Q	5006	G1090993	IC	M5M82C55AFP-2D7
Q	5007	G1090993	IC	M5M82C55AFP-2D7
Q	5008	G1091023	IC	TC74HC138F TP2
Q	5009	G1091023	IC	TC74HC138F TP2
Q	5010	G1090996	IC	MC74HC32FL
Q	5011	G1091010	IC	TC74HC173AF-TP2
Q	5012	G1090996	IC	MC74HC32FL
Q	5013	G1090997	IC	MC74HC00FL
Q	5014	G1090997	IC	MC74HC00FL
Q	5015	G1090997	IC	MC74HC00FL
Q	5016	G1091011	IC	TC74HC541AF-TP2
Q	5017	G1091011	IC	TC74HC541AF-TP2
Q	5018	G1091011	IC	TC74HC541AF-TP2
Q	5019	G1091011	IC	TC74HC541AF-TP2
Q	5020	G1091012	IC	TC74HC191AF-TP2
Q	5021	G1091012	IC	TC74HC191AF-TP2
Q	5022	G1091012	IC	TC74HC191AF-TP2
Q	5023	G1091012	IC	TC74HC191AF-TP2
Q	5024	G1091012	IC	TC74HC191AF-TP2
Q	5025	G1091012	IC	TC74HC191AF-TP2
Q	5026	G1091012	IC	TC74HC191AF-TP2
Q	5027	G1091012	IC	TC74HC191AF-TP2
Q	5028	G1090994	IC	MC14013BFL
Q	5029	G1090994	IC	MC14013BFL
Q	5030	G1091021	IC	TC4072BF TP2
Q	5031	G1091021	IC	TC4072BF TP2
Q	5032	G1091021	IC	TC4072BF TP2
Q	5033	G1091022	IC	TC4081BF TP2
Q	5034	G1091022	IC	TC4081BF TP2
Q	5035	G1091022	IC	TC4081BF TP2
Q	5036	G1090995	IC	MC14584BFL
Q	5037	G1090995	IC	MC14584BFL
Q	5038	G1090995	IC	MC14584BFL
Q	5039	G1090987	IC	UPD74HC239G-T2
Q	5040	G1090998	IC	MC14028BFL
Q	5041	G1090998	IC	MC14028BFL
Q	5042	G1090721	IC	M54563P
Q	5043	G1090836	IC	M54564P
Q	5044	G1090836	IC	M54564P
Q	5045	G1090836	IC	M54564P

For Service Manuals Contact
MAURITRON TECHNICAL SERVICES
 8 Cherry Tree Rd, Chinnor
 Oxon OX9 4QY
 Tel:- 01844-351694 Fax:- 01844-352554
 Email: enquires@mauritron.co.uk

Control Unit Parts List

ADD	CODE NO	DESCRIPTION	DEVICE	TYP VAL
Q 5046	G1090990	IC	M5223FP-72A	
Q 5047	G1090991	IC	M51943BML-301	
Q 5048	G1091014	IC	TA78L05F TE12R	
Q 5049	G3111627G	TRANSISTOR	2SA1162GR TE85R	
Q 5050	G3327127G	TRANSISTOR	2SC2712GR TE85R	
Q 5051	G3327127G	TRANSISTOR	2SC2712GR TE85R	
Q 5052	G3070001	TRANSISTOR	FA1A4M-T2B	
Q 5053	G3070001	TRANSISTOR	FA1A4M-T2B	
Q 5055	G1090975	IC	TC74HC08AF TP2	
Q 5056	G1090975	IC	TC74HC08AF TP2	
Q 5057	G1090975	IC	TC74HC08AF TP2	
Q 5058	G1090975	IC	TC74HC08AF TP2	
R 5001	J24205222	CHIP RES.	RMC1/10T 222J	2.2K 1/10W
R 5002	J24205102	CHIP RES.	RMC1/10T 102J	1K 1/10W
R 5003	J24205223	CHIP RES.	RMC1/10T 223J	22K 1/10W
R 5004	J24205472	CHIP RES.	RMC1/10T 472J	4.7K 1/10W
R 5005	J24205472	CHIP RES.	RMC1/10T 472J	4.7K 1/10W
R 5006	J24205104	CHIP RES.	RMC1/10T 104J	100K 1/10W
R 5007	J24205104	CHIP RES.	RMC1/10T 104J	100K 1/10W
R 5008	J24205104	CHIP RES.	RMC1/10T 104J	100K 1/10W
R 5009	J24206101	CHIP RES.	RMC1/10T 101J	100 1/10W
R 5010	J24205102	CHIP RES.	RMC1/10T 102J	1K 1/10W
R 5011	J24205473	CHIP RES.	RMC1/10T 473J	47K 1/10W
R 5012	J24205103	CHIP RES.	RMC1/10T 103J	10K 1/10W
R 5013	J24205823	CHIP RES.	RMC1/10T 823J	82K 1/10W
R 5015	J24205103	CHIP RES.	RMC1/10T 103J	10K 1/10W
R 5016	J24205104	CHIP RES.	RMC1/10T 104J	100K 1/10W
R 5017	J24205104	CHIP RES.	RMC1/10T 104J	100K 1/10W
R 5018	J24205473	CHIP RES.	RMC1/10T 473J	47K 1/10W
R 5019	J24205104	CHIP RES.	RMC1/10T 104J	100K 1/10W
R 5020	J24205104	CHIP RES.	RMC1/10T 104J	100K 1/10W
R 5021	J24205104	CHIP RES.	RMC1/10T 104J	100K 1/10W
R 5022	J24205104	CHIP RES.	RMC1/10T 104J	100K 1/10W
R 5023	J24205473	CHIP RES.	RMC1/10T 473J	47K 1/10W
R 5024	J24205333	CHIP RES.	RMC1/10T 333J	33K 1/10W
R 5025	J24205333	CHIP RES.	RMC1/10T 333J	33K 1/10W
R 5026	J24205104	CHIP RES.	RMC1/10T 104J	100K 1/10W
R 5027	J24205104	CHIP RES.	RMC1/10T 104J	100K 1/10W
R 5028	J24205473	CHIP RES.	RMC1/10T 473J	47K 1/10W
R 5029	J24205473	CHIP RES.	RMC1/10T 473J	47K 1/10W
R 5030	J24205473	CHIP RES.	RMC1/10T 473J	47K 1/10W
R 5031	J24205473	CHIP RES.	RMC1/10T 473J	47K 1/10W
R 5032	J24205103	CHIP RES.	RMC1/10T 103J	10K 1/10W
R 5033	J24205473	CHIP RES.	RMC1/10T 473J	47K 1/10W
R 5034	J24205333	CHIP RES.	RMC1/10T 333J	33K 1/10W
R 5035	J24205333	CHIP RES.	RMC1/10T 333J	33K 1/10W
R 5036	J24205104	CHIP RES.	RMC1/10T 104J	100K 1/10W
R 5037	J24205104	CHIP RES.	RMC1/10T 104J	100K 1/10W
R 5038	J24205473	CHIP RES.	RMC1/10T 473J	47K 1/10W
R 5039	J24205473	CHIP RES.	RMC1/10T 473J	47K 1/10W
R 5040	J24205473	CHIP RES.	RMC1/10T 473J	47K 1/10W
R 5041	J24205473	CHIP RES.	RMC1/10T 473J	47K 1/10W
R 5042	J24205103	CHIP RES.	RMC1/10T 103J	10K 1/10W
R 5043	J24205473	CHIP RES.	RMC1/10T 473J	47K 1/10W
R 5044	J24205333	CHIP RES.	RMC1/10T 333J	33K 1/10W
R 5045	J24205333	CHIP RES.	RMC1/10T 333J	33K 1/10W
R 5046	J24205104	CHIP RES.	RMC1/10T 104J	100K 1/10W
R 5047	J24205104	CHIP RES.	RMC1/10T 104J	100K 1/10W
R 5048	J24205473	CHIP RES.	RMC1/10T 473J	47K 1/10W
R 5049	J24205473	CHIP RES.	RMC1/10T 473J	47K 1/10W
R 5050	J24205473	CHIP RES.	RMC1/10T 473J	47K 1/10W
R 5051	J24205473	CHIP RES.	RMC1/10T 473J	47K 1/10W
R 5052	J24205103	CHIP RES.	RMC1/10T 103J	10K 1/10W
R 5053	J24205473	CHIP RES.	RMC1/10T 473J	47K 1/10W
R 5054	J24205101	CHIP RES.	RMC1/10T 101J	100 1/10W
R 5055	J24205101	CHIP RES.	RMC1/10T 101J	100 1/10W
R 5056	J24205101	CHIP RES.	RMC1/10T 101J	100 1/10W
R 5057	J24205101	CHIP RES.	RMC1/10T 101J	100 1/10W
R 5058	J24205101	CHIP RES.	RMC1/10T 101J	100 1/10W
R 5059	J24205101	CHIP RES.	RMC1/10T 101J	100 1/10W
R 5060	J24205101	CHIP RES.	RMC1/10T 101J	100 1/10W
R 5061	J24205101	CHIP RES.	RMC1/10T 101J	100 1/10W
R 5062	J24205104	CHIP RES.	RMC1/10T 104J	100K 1/10W
R 5066	J24205122	CHIP RES.	RMC1/10T 122J	1.2K 1/10W
R 5067	J24205122	CHIP RES.	RMC1/10T 122J	1.2K 1/10W
R 5068	J24205122	CHIP RES.	RMC1/10T 122J	1.2K 1/10W
R 5069	J24205122	CHIP RES.	RMC1/10T 122J	1.2K 1/10W
R 5070	J24205104	CHIP RES.	RMC1/10T 104J	100K 1/10W
R 5071	J24205104	CHIP RES.	RMC1/10T 104J	100K 1/10W
R 5072	J24205104	CHIP RES.	RMC1/10T 104J	100K 1/10W
R 5073	J24205104	CHIP RES.	RMC1/10T 104J	100K 1/10W
R 5074	J24205104	CHIP RES.	RMC1/10T 104J	100K 1/10W
R 5075	J24205104	CHIP RES.	RMC1/10T 104J	100K 1/10W

Control Unit Parts List

ADD	CODE NO	DESCRIPTION	DEVICE	TYP VAL
R 5076	J24205104	CHIP RES.	RMC1/10T 104J	100K 1/10W
R 5077	J24205104	CHIP RES.	RMC1/10T 104J	100K 1/10W
R 5078	J24205104	CHIP RES.	RMC1/10T 104J	100K 1/10W
R 5079	J24205104	CHIP RES.	RMC1/10T 104J	100K 1/10W
R 5081	J24205104	CHIP RES.	RMC1/10T 104J	100K 1/10W
R 5082	J24205104	CHIP RES.	RMC1/10T 104J	100K 1/10W
R 5083	J24205122	CHIP RES.	RMC1/10T 122J	1.2K 1/10W
R 5084	J24205122	CHIP RES.	RMC1/10T 122J	1.2K 1/10W
R 5085	J24205122	CHIP RES.	RMC1/10T 122J	1.2K 1/10W
R 5086	J24205122	CHIP RES.	RMC1/10T 122J	1.2K 1/10W
R 5088	J24205104	CHIP RES.	RMC1/10T 104J	100K 1/10W
R 5089	J24205104	CHIP RES.	RMC1/10T 104J	100K 1/10W
R 5090	J24205104	CHIP RES.	RMC1/10T 104J	100K 1/10W
R 5091	J24205104	CHIP RES.	RMC1/10T 104J	100K 1/10W
R 5092	J24205104	CHIP RES.	RMC1/10T 104J	100K 1/10W
R 5093	J24205153	CHIP RES.	RMC1/10T 153J	15K 1/10W
R 5094	J24205103	CHIP RES.	RMC1/10T 103J	10K 1/10W
R 5095	J24205104	CHIP RES.	RMC1/10T 104J	100K 1/10W
R 5096	J24205104	CHIP RES.	RMC1/10T 104J	100K 1/10W
R 5097	J24205104	CHIP RES.	RMC1/10T 104J	100K 1/10W
R 5100	J24205104	CHIP RES.	RMC1/10T 104J	100K 1/10W
R 5101	J24205104	CHIP RES.	RMC1/10T 104J	100K 1/10W
R 5102	J24205104	CHIP RES.	RMC1/10T 104J	100K 1/10W
R 5103	J24205104	CHIP RES.	RMC1/10T 104J	100K 1/10W
R 5104	J24205471	CHIP RES.	RMC1/10T 471J	470 1/10W
R 5105	J24205681	CHIP RES.	RMC1/10T 681J	680 1/10W
R 5106	J24205104	CHIP RES.	RMC1/10T 104J	100K 1/10W
R 5108	J24205104	CHIP RES.	RMC1/10T 104J	100K 1/10W
R 5109	J24205103	CHIP RES.	RMC1/10T 103J	10K 1/10W
R 5110	J24205103	CHIP RES.	RMC1/10T 103J	10K 1/10W
R 5112	J24205103	CHIP RES.	RMC1/10T 103J	10K 1/10W
R 5113	J24205103	CHIP RES.	RMC1/10T 103J	10K 1/10W
R 5114	J24205103	CHIP RES.	RMC1/10T 103J	10K 1/10W
X 5001	H0102937	XTAL		12.288MHZ

For Service Manuals Contact
MAURITRON TECHNICAL SERVICES
 8 Cherry Tree Rd, Chinnor
 Oxon OX9 4QY
 Tel: 01844-351694 Fax: 01844-352554
 Email: enquiries@mauriron.co.uk

Notes

For Service Manuals Contact
MAURITRON TECHNICAL SERVICES
8 Cherry Tree Rd, Chinnor
Oxon OX9 4QY
Tel: 01844-351694 Fax: 01844-352554
Email: enquiries@mauriton.co.uk

For Service Manuals Contact
MAURITRON TECHNICAL SERVICES
8 Cherry Tree Rd, Chinnor
Oxon OX9 4QY
Tel:- 01844-351694 Fax:- 01844-352554
Email:- enquiries@mauritron.co.uk

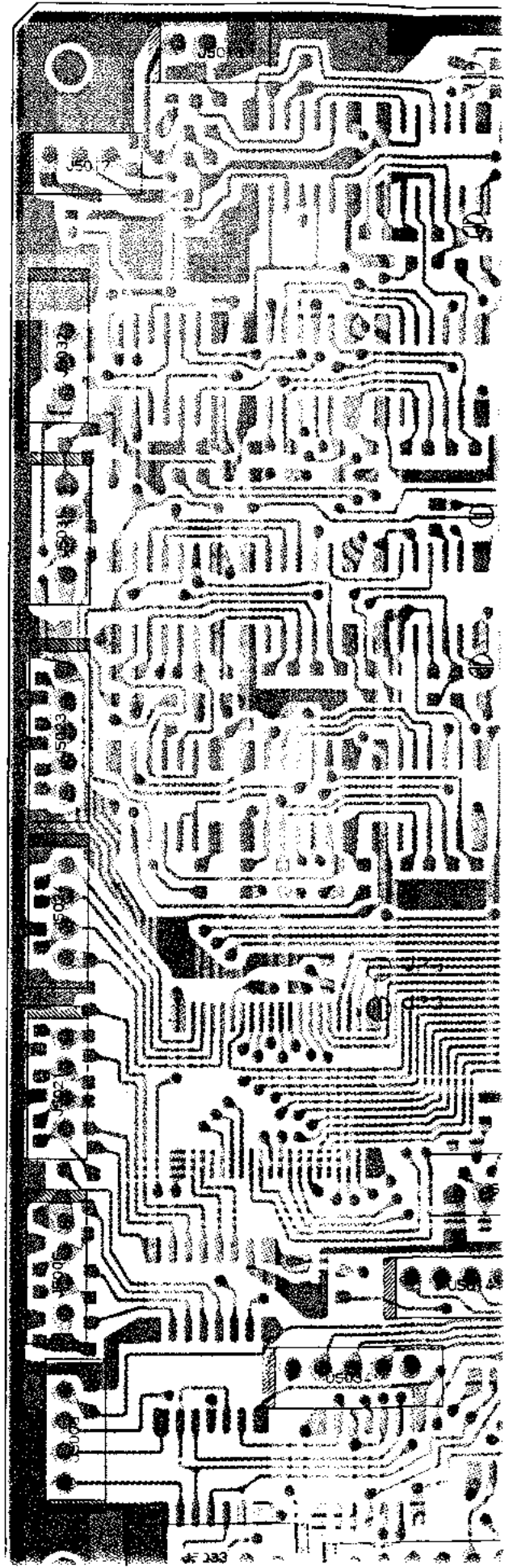

For Service Manuals Contact
MAURITRON TECHNICAL SERVICES

Oxon OX9 4QY

Tel: 01844-351694 Fax: 01844-352554

Email: enquiries@maurifron.co.uk

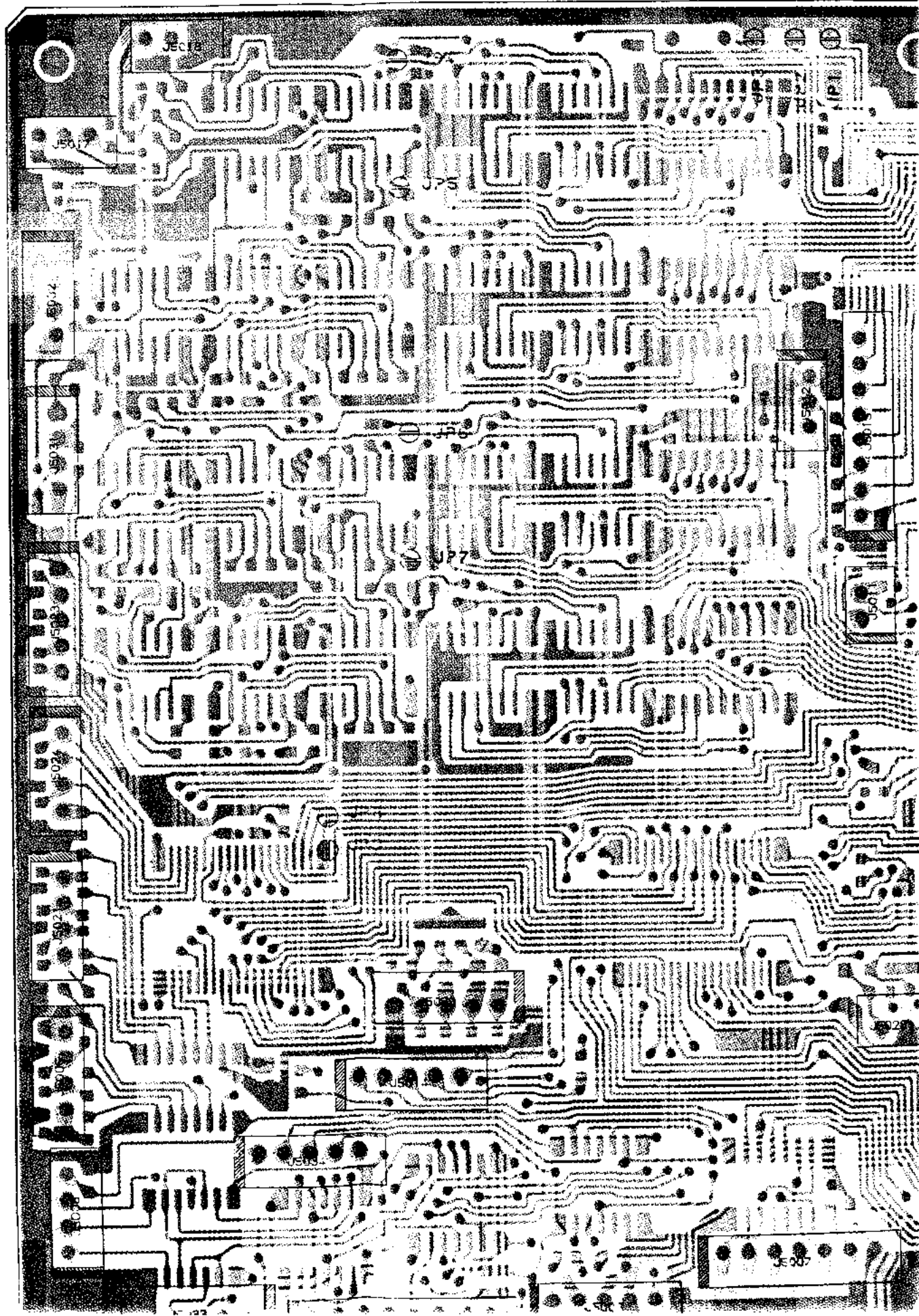

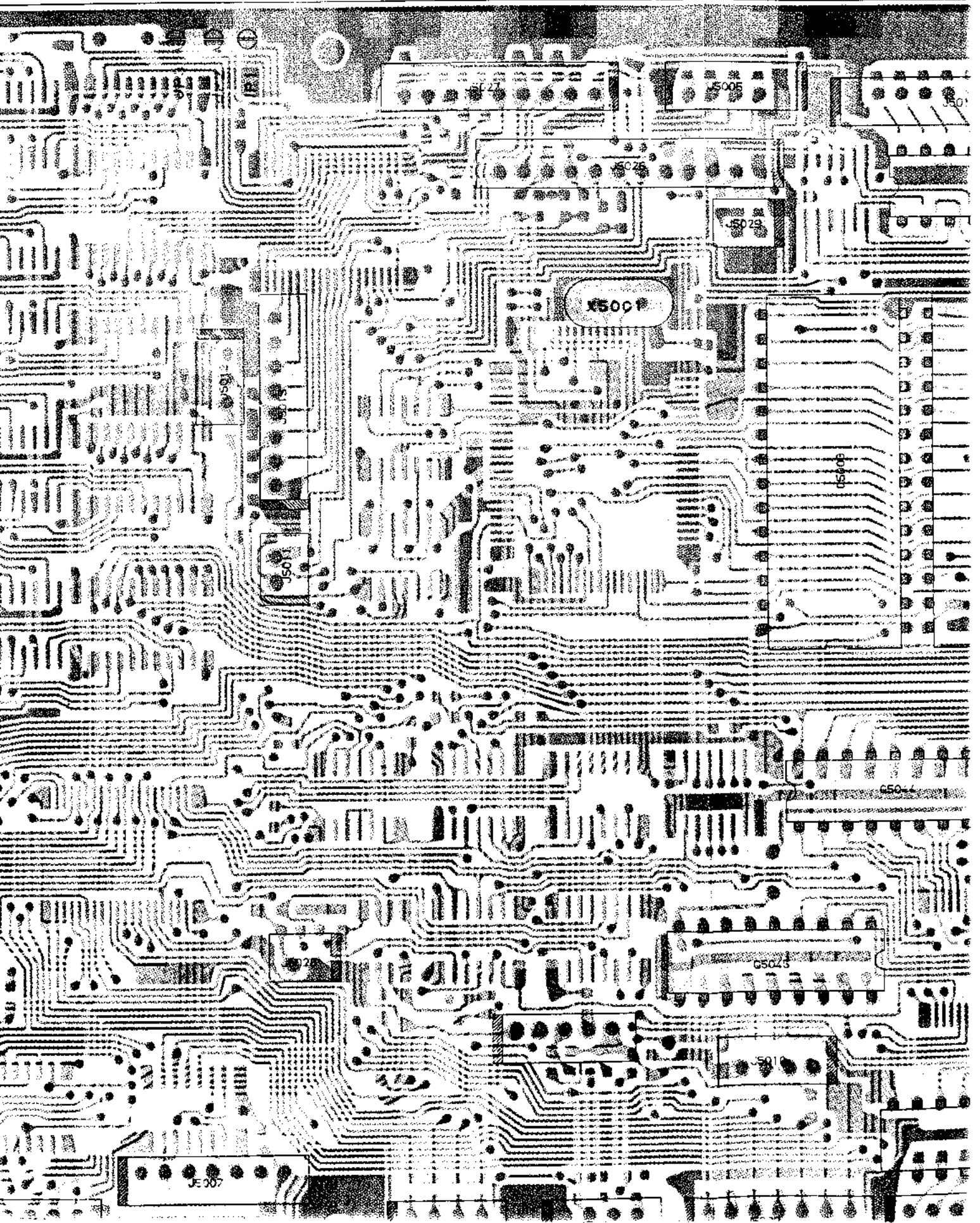

Control Unit Board Layout

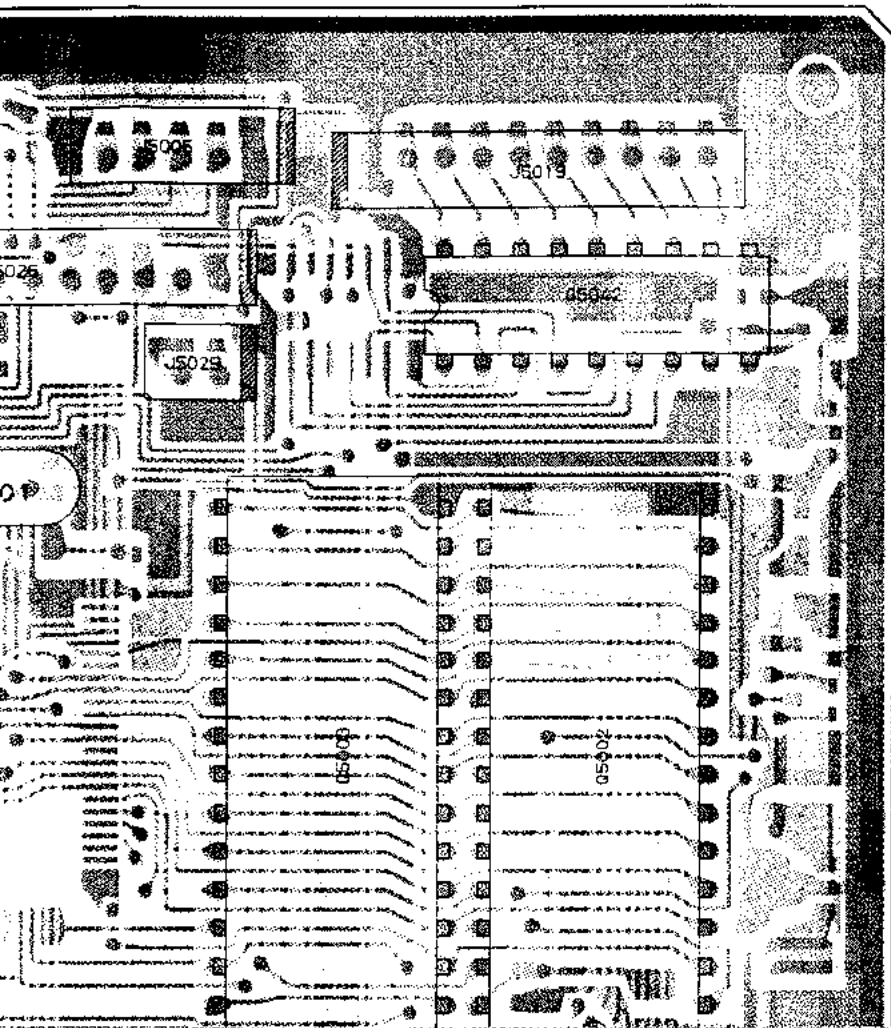

For Service Manuals Contact
MAURITRON TECHNICAL SERVICES
8 Cherry Tree Rd, Chinnor
Oxon OX9 4QY
Tel:- 01844-351694 Fax:- 01844-352554
Email:- enquires@mauritron.co.uk

6-1

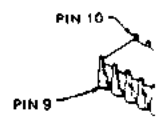
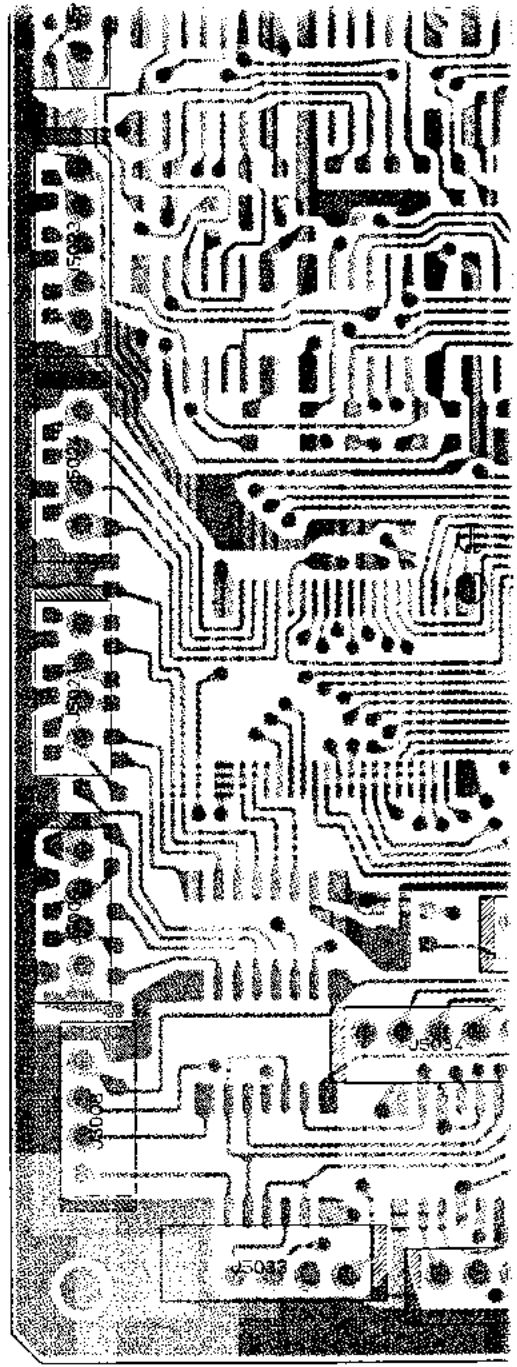

M54563P
(Q5042)
M54564P
(Q5044)

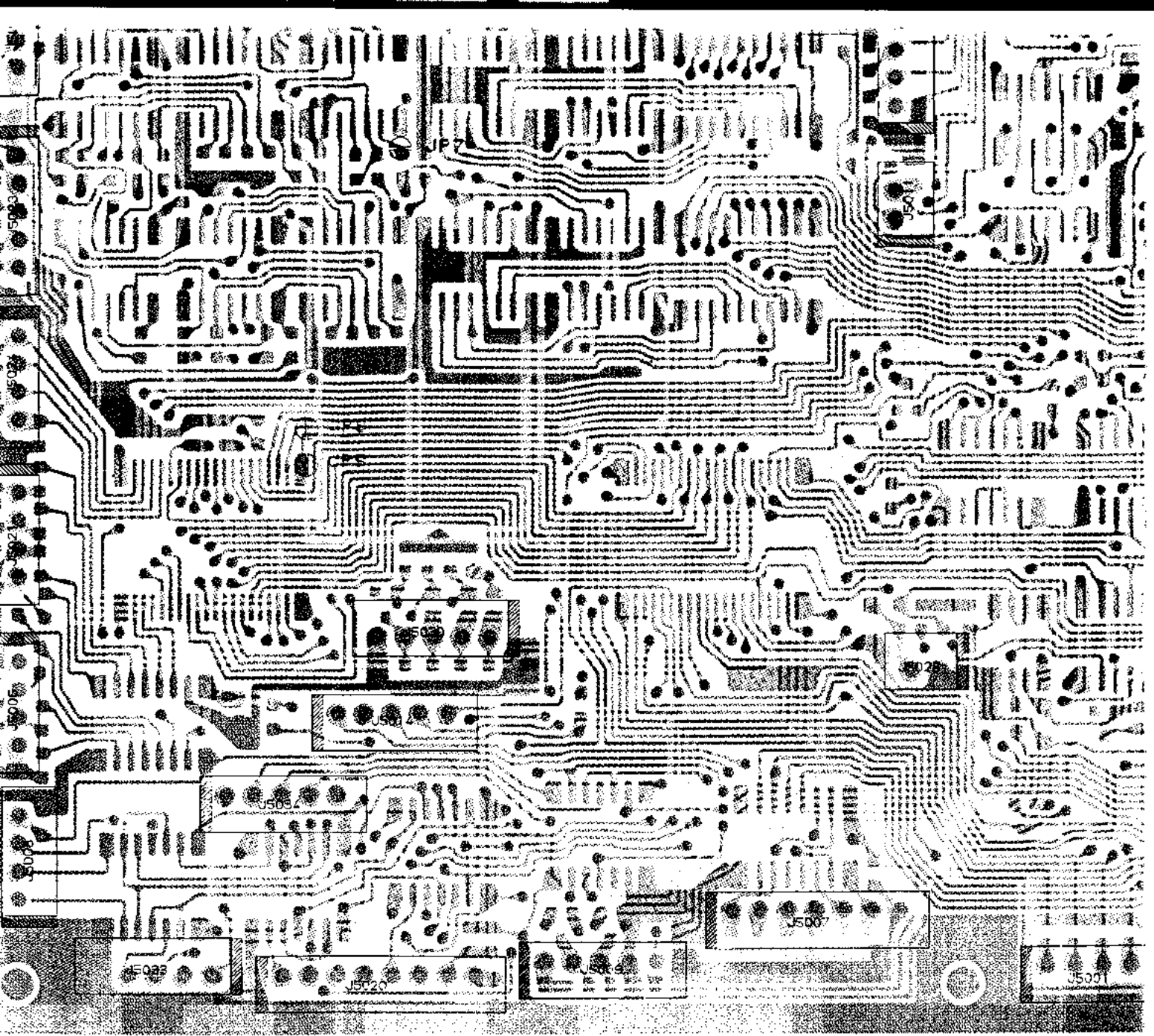

For Service Manuals Contact
MAURITRON TECHNICAL SERVICES
 8 Cherry Tree Rd, Chinnor
 Oxon OX9 4QY
 Tel: 01844-351694 Fax: 01844-352554
 Email: enquiries@mauriron.co.uk

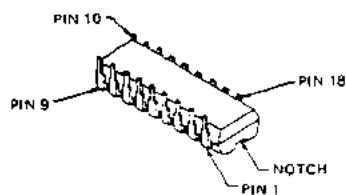

M54563P
 (Q5042)
 M54564P
 (Q5044, Q5045, Q5043)

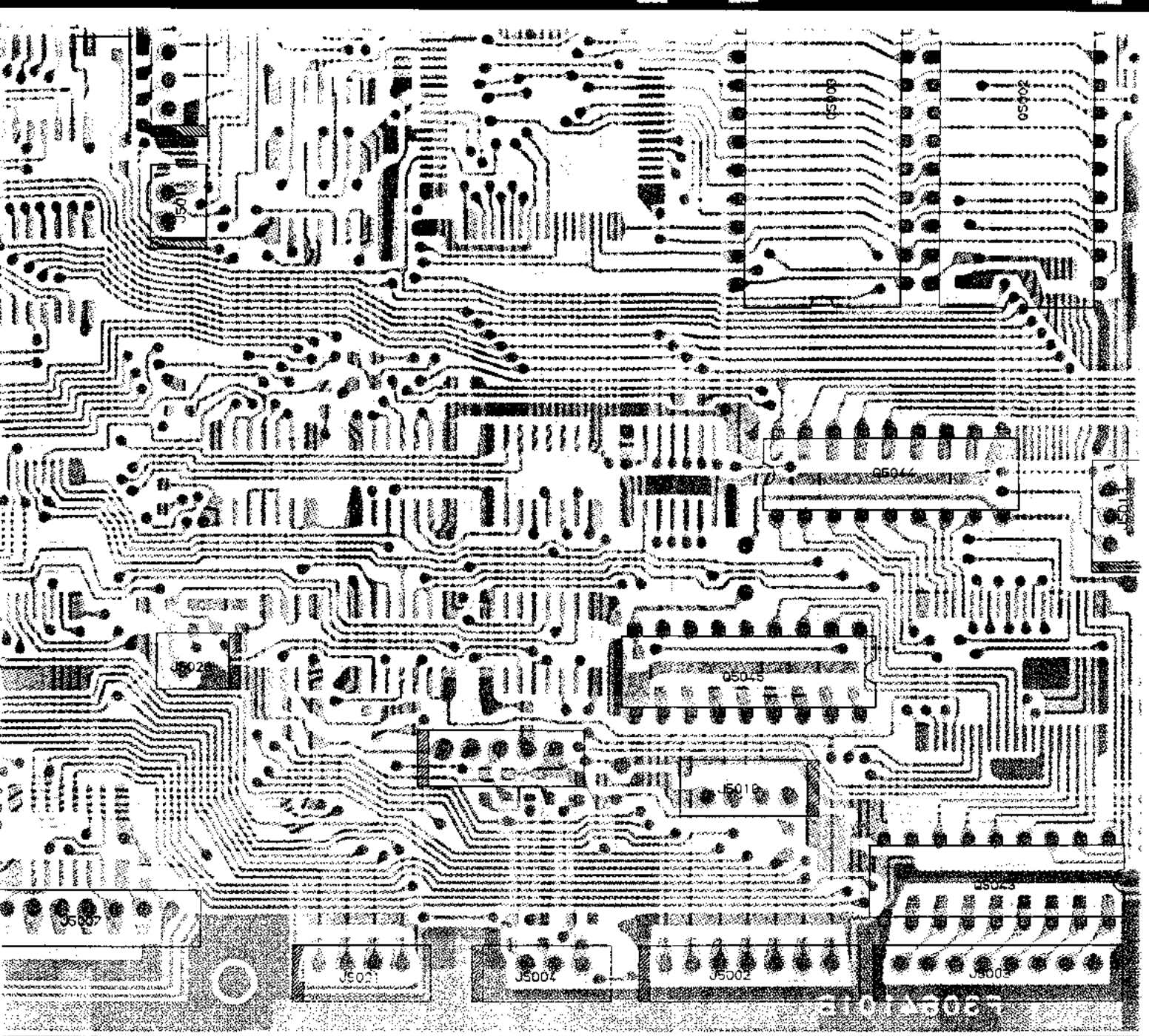

(obverse view of "component" side)

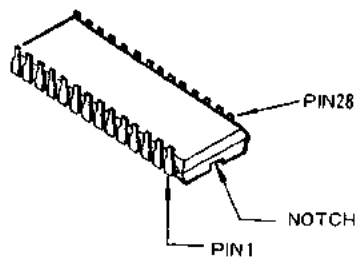

- LH5164L-15
- (Q5002)
- TC57256AD-15
- (Q5003)

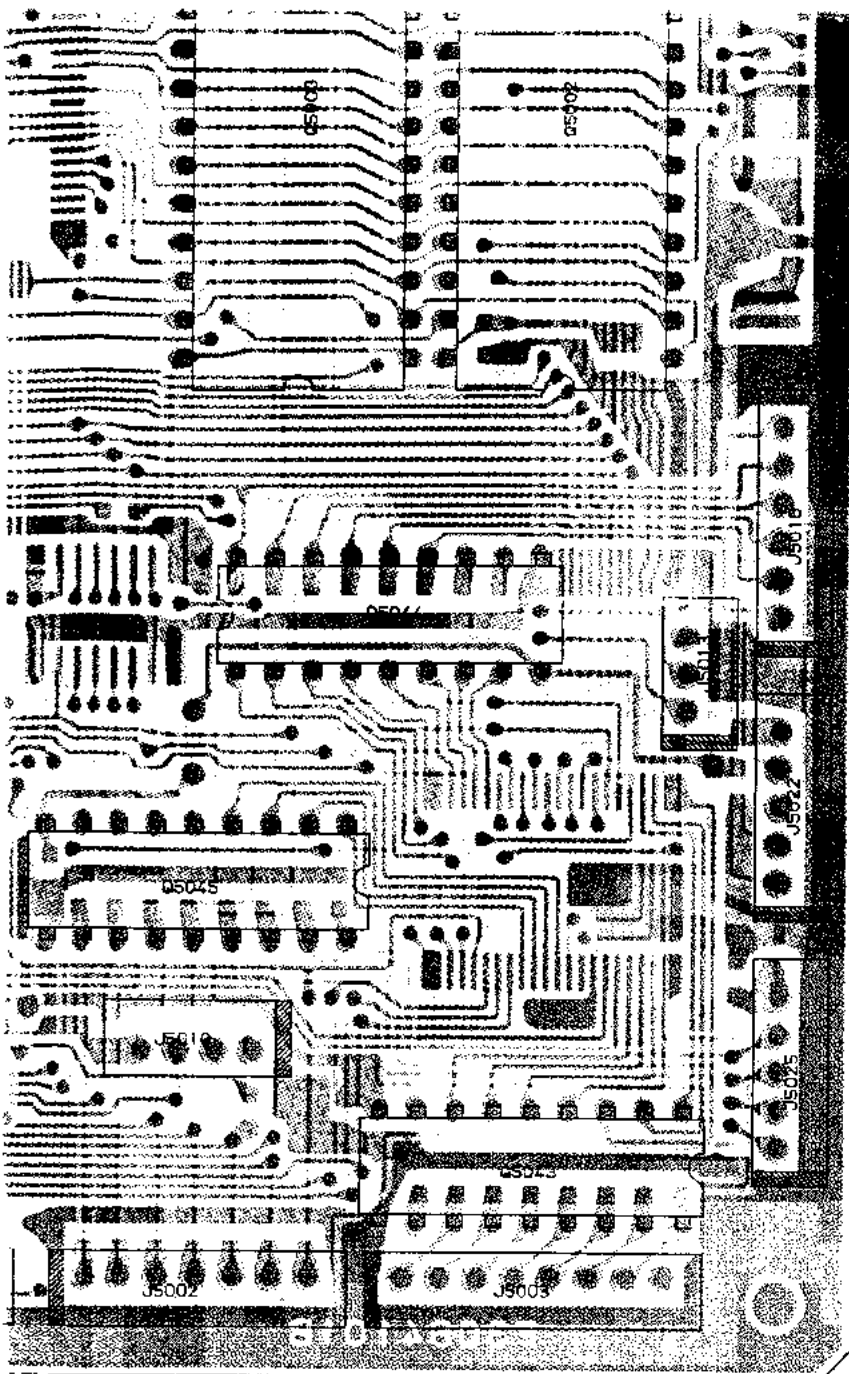

(obverse view of "component" side)

For Service Manuals Contact
MAURITRON TECHNICAL SERVICES
 B Cherry Tree Rd, Chinnor
 Oxon OX9 4QY
 Tel:- 01844-351694 Fax:- 01844-352554
 Email:- enquires@mauritron.co.uk

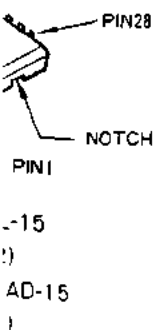

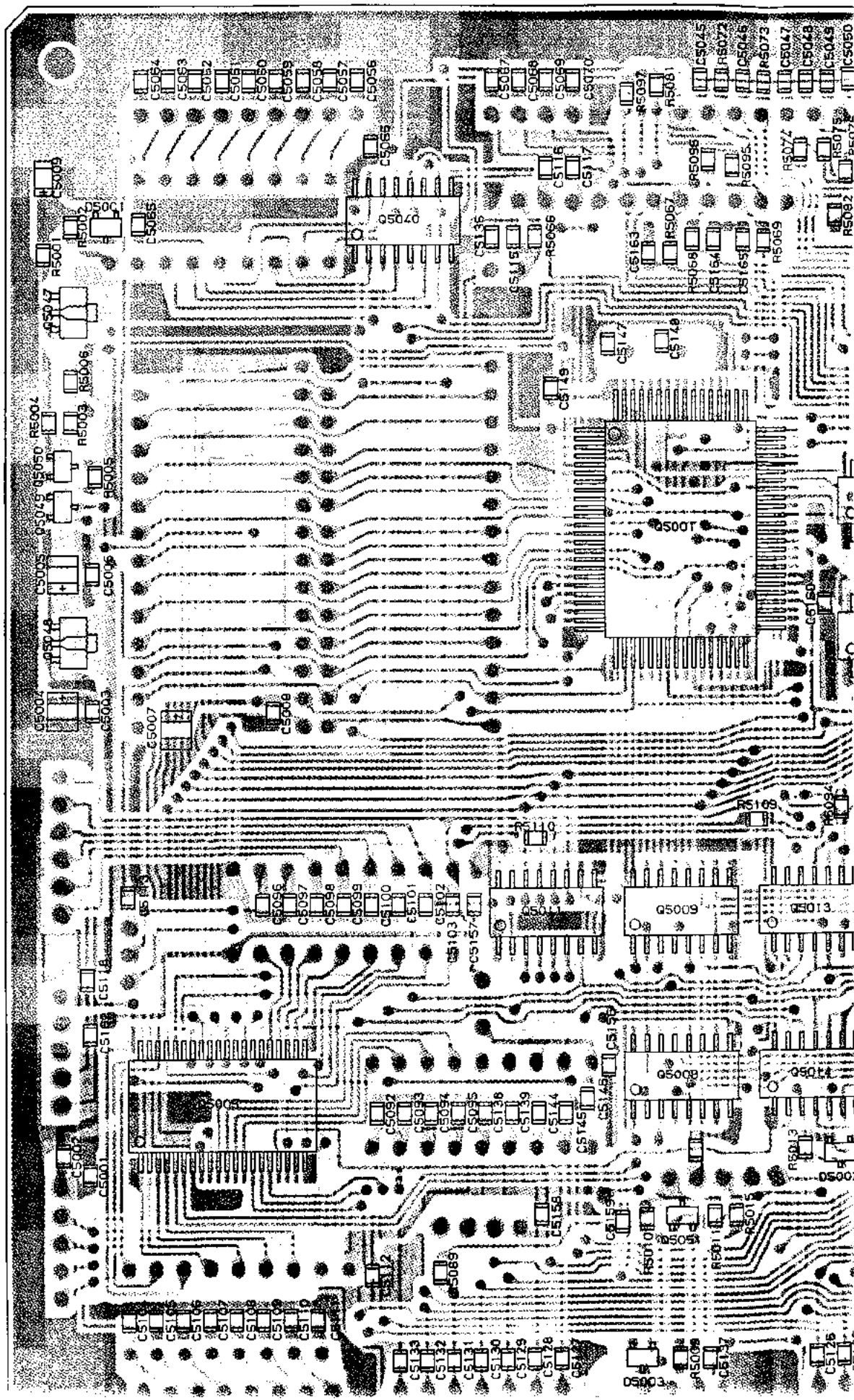

For Service Manuals Contact
MAURITRON TECHNOLOGY SERVICES
8 Cherry Tree Rd, Chinnor
Oxon OX9 4QY
Tel: 01844-351694 Fax: 01844-352554
Email: enquiries@mauritron.co.uk

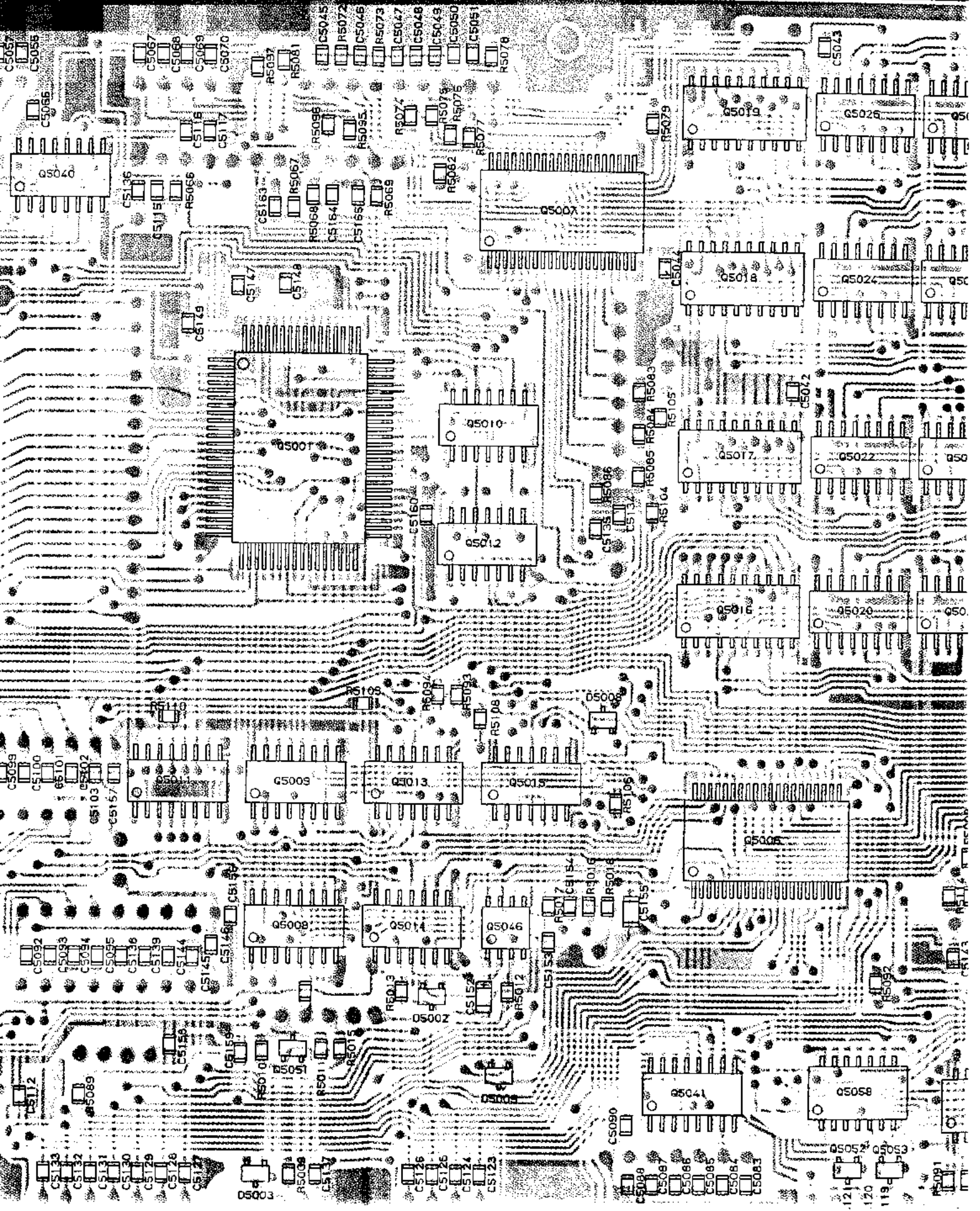

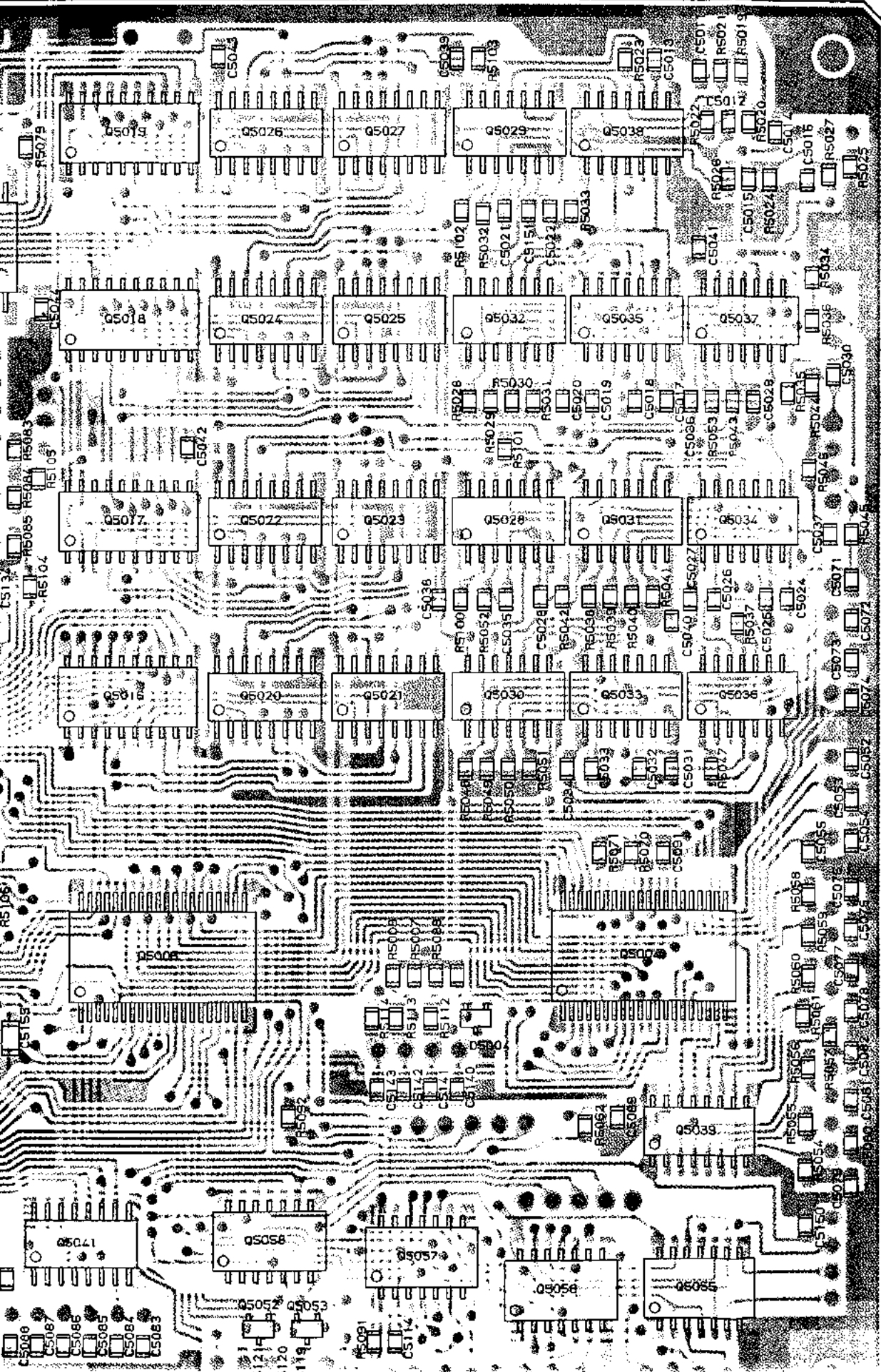

PIN 16

WPC
C
MC

Control Unit Board Layout

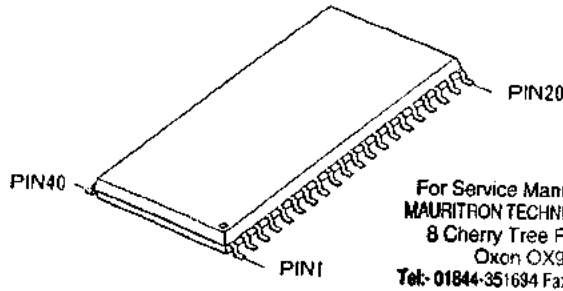
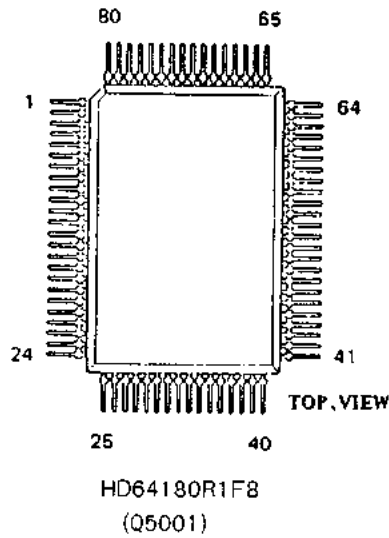
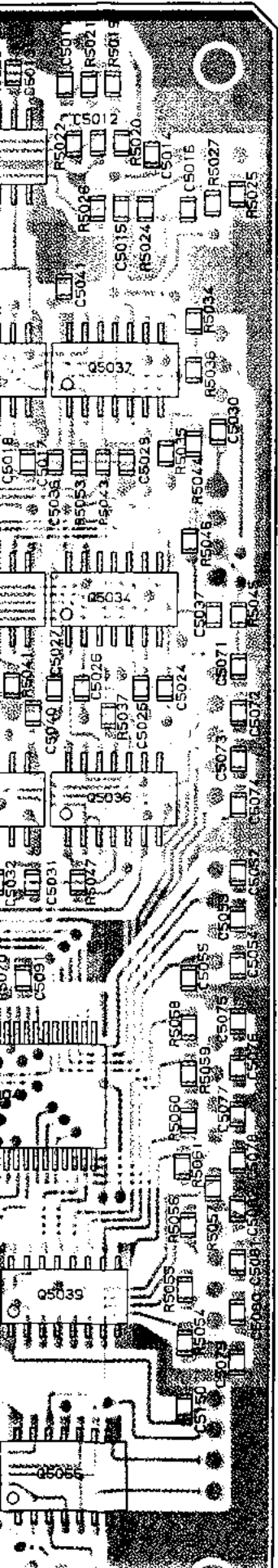

For Service Manuals Contact
MAURITRON TECHNICAL SERVICES
8 Cherry Tree Rd, Chinner
Oxon OX9 4QY
Tel: 01844-351694 Fax: 01844-352554
Email: enquires@mauritron.co.uk

M5M82055AFP
(Q5004, Q5005, Q5006, Q5007)

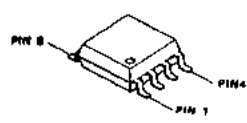

M5223FP-72A
(Q5046)

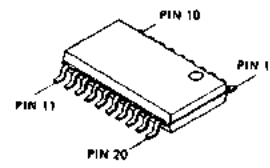

TC74HC541AF
(Q5016, Q5017,
Q5018, Q5019)

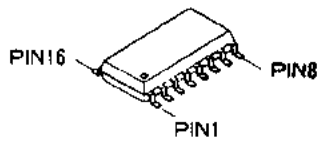

μPD74HC239G
(Q5039)
MC14028BFL

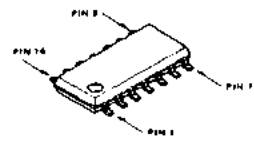

MC14013BFL
(Q5028, Q5029)
MC14584BFL

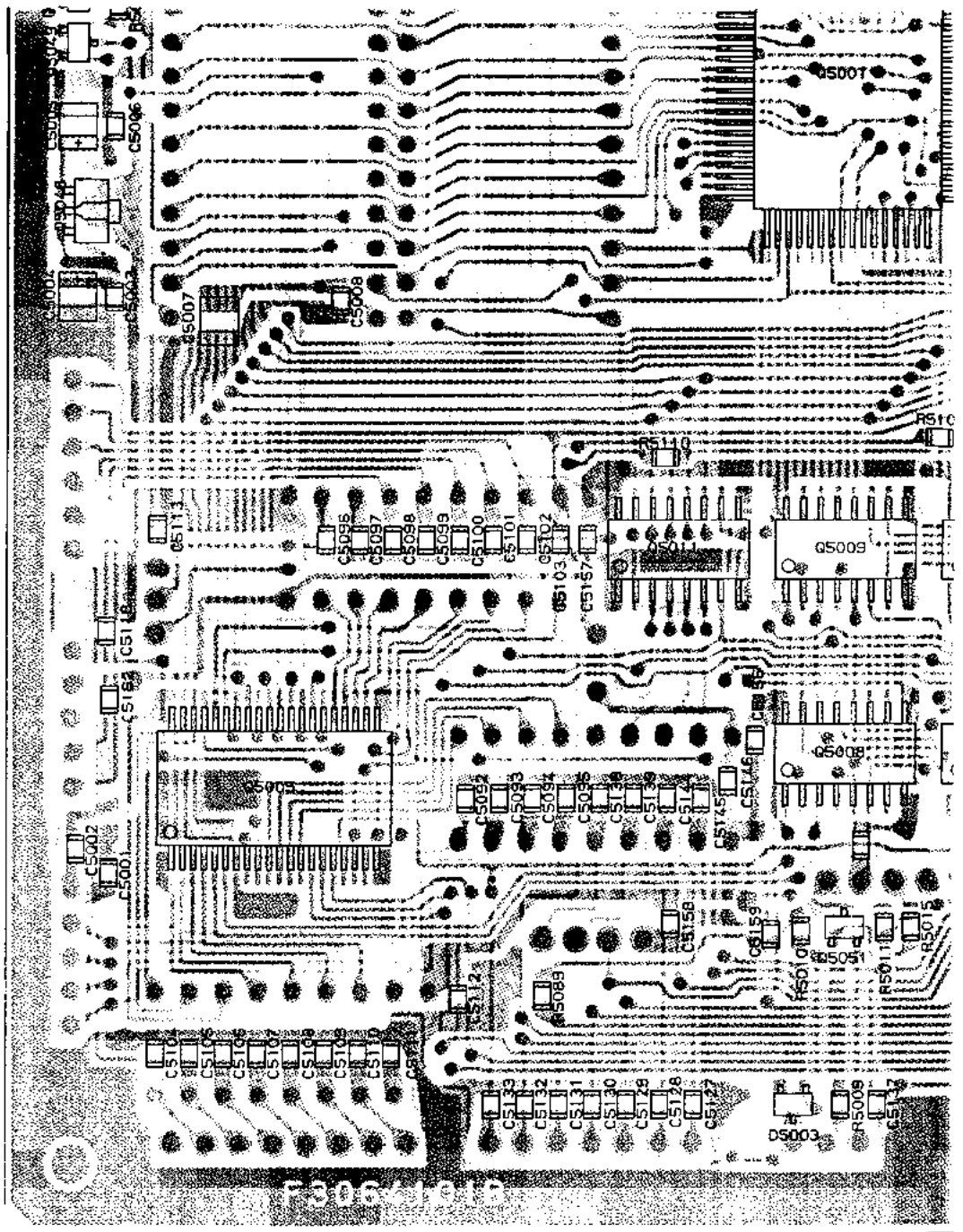

For Service Manuals Contact
MAURITRON TECHNICAL SERVICES
 8 Cherry Tree Rd, Chinnor
 Oxon OX9 4QY
 Tel: 01844-351894 Fax: 01844-352554
 Email: enquiries@mauritron.co.uk

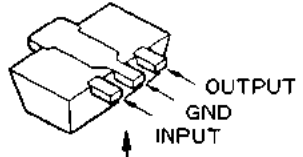

Marked Surface
TA78L05F (05)
 (Q5048)

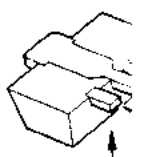

Marked S
M51943E
 (Q5047)

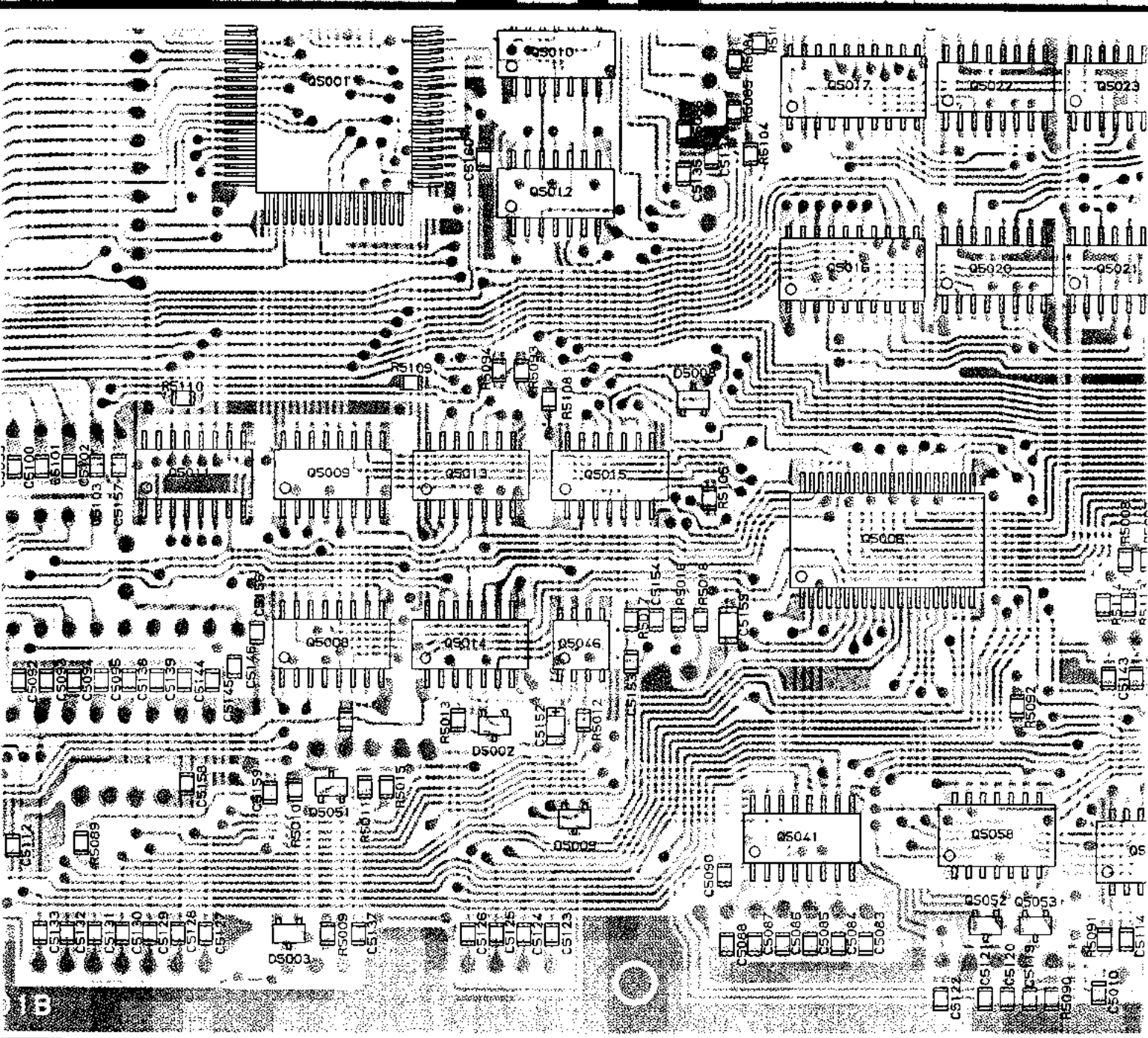

UT

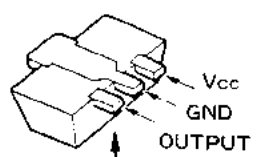

Marked Surface
 M51943BML (A4)
 (Q5047)

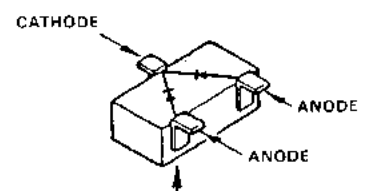

Marked Surface
 MC2838 (A6)
 (D5001, D5002, D5003,
 D5004, D5008, D5009)

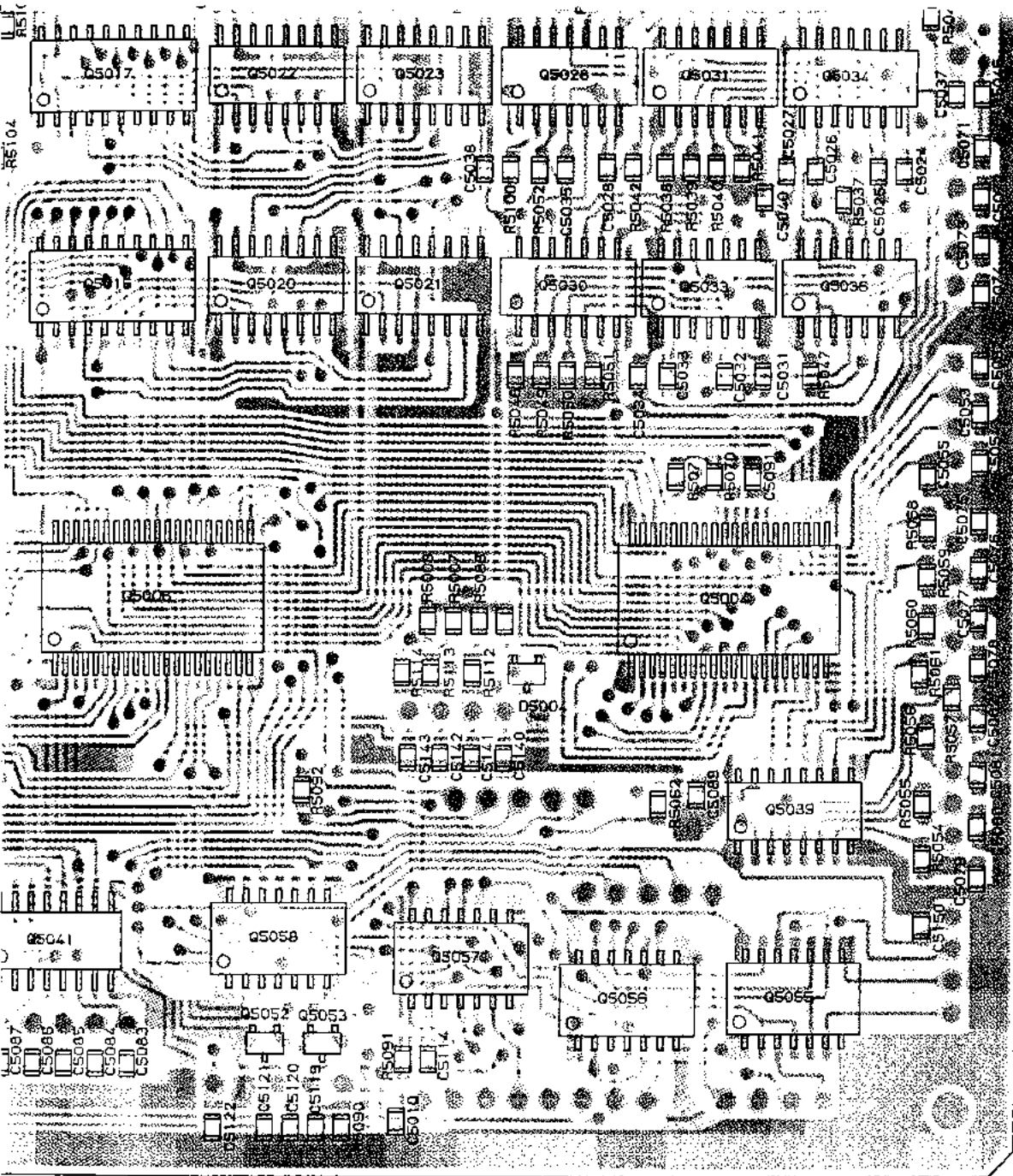

(obverse view of "chip-only" side)

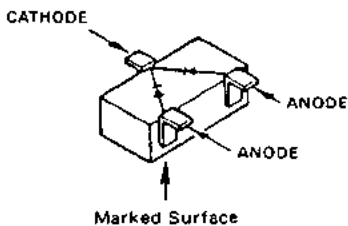

MC2838 (A6)

(D5001, D5002, D5003,
D5004, D5008, D5009)

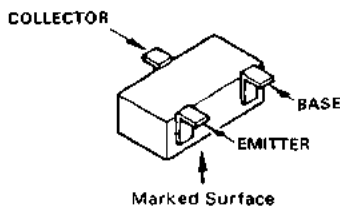

FA1A4M (L33)

(Q5052, Q5053)
2SA1162GR (SG)
(Q5049)
2SC2712GR (LG)
(Q5050, Q5051)

For Service Manuals Contact
MAURITRON TECHNICAL SERVICES
8 Cherry Tree Rd, Chinnor
Oxon OX9 4QY
Tel: 01844-351694 Fax: 01844-352554
Email: enquiries@mauritron.co.uk

M5223
(Q50)

PIN16

µPD74HC
(Q5039)

MC1402E
(Q5040)

TC74HC1
(Q5011)

TC74HC1
(Q502)

(Q502)

(Q502)

(Q502)

TC74HC1
(Q5008)

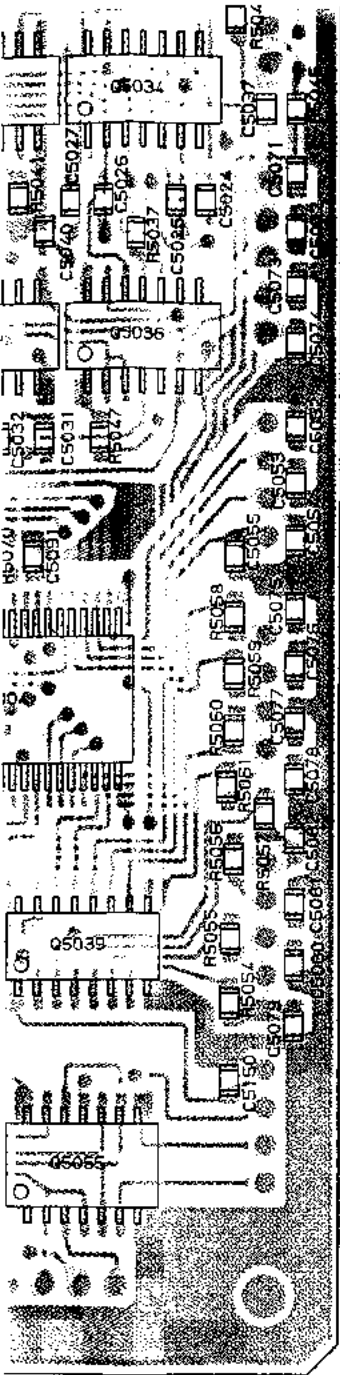

p-only" side)

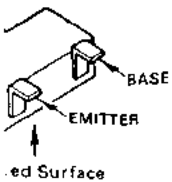

- 4M(L33)
- Q52, Q5053)
- 62GR(SG)
- Q49)
- 12GR(LG)
- Q50, Q5051)

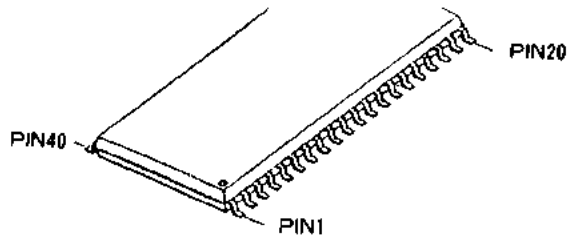

M5M82055AFP
(Q5004, Q5005, Q5006, Q5007)

For Service Manuals Contact
MAURITRON TECHNICAL SERVICES
8 Cherry Tree Rd, Chinnor
Oxon OX9 4QY
Tel: 01844 351694 Fax: 01844 352554
Email: enquiries@mauritron.co.uk

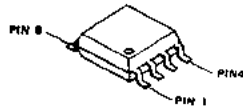

M5223FP-72A
(Q5046)

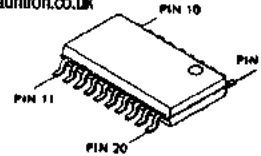

TC74HC541AF
(Q5016, Q5017,
Q5018, Q5019)

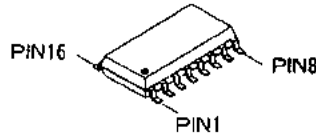

µPD74HC239G
(Q5039)
MC14028BFL
(Q5040, Q5041)
TC74HC173AF
(Q5011)
TC74HC191AF
(Q5020, Q5021,
Q5022, Q5023,
Q5024, Q5025,
Q5026, Q5027)
TC74HC138F
(Q5008, Q5009)

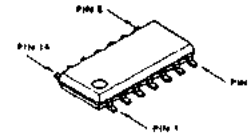

MC14013BFL
(Q5028, Q5029)
MC14584BFL
(Q5036, Q5037, Q5038)
MC74HC32FL
(Q5010, Q5012)
MC74HC00FL
(Q5013, Q5014, Q5015)
TC4072BF
(Q5030, Q5031, Q5032)
TC4081BF
(Q5033, Q5034, Q5035)
TC74HC08AF
(Q5055, Q5056,
Q5057, Q5058)

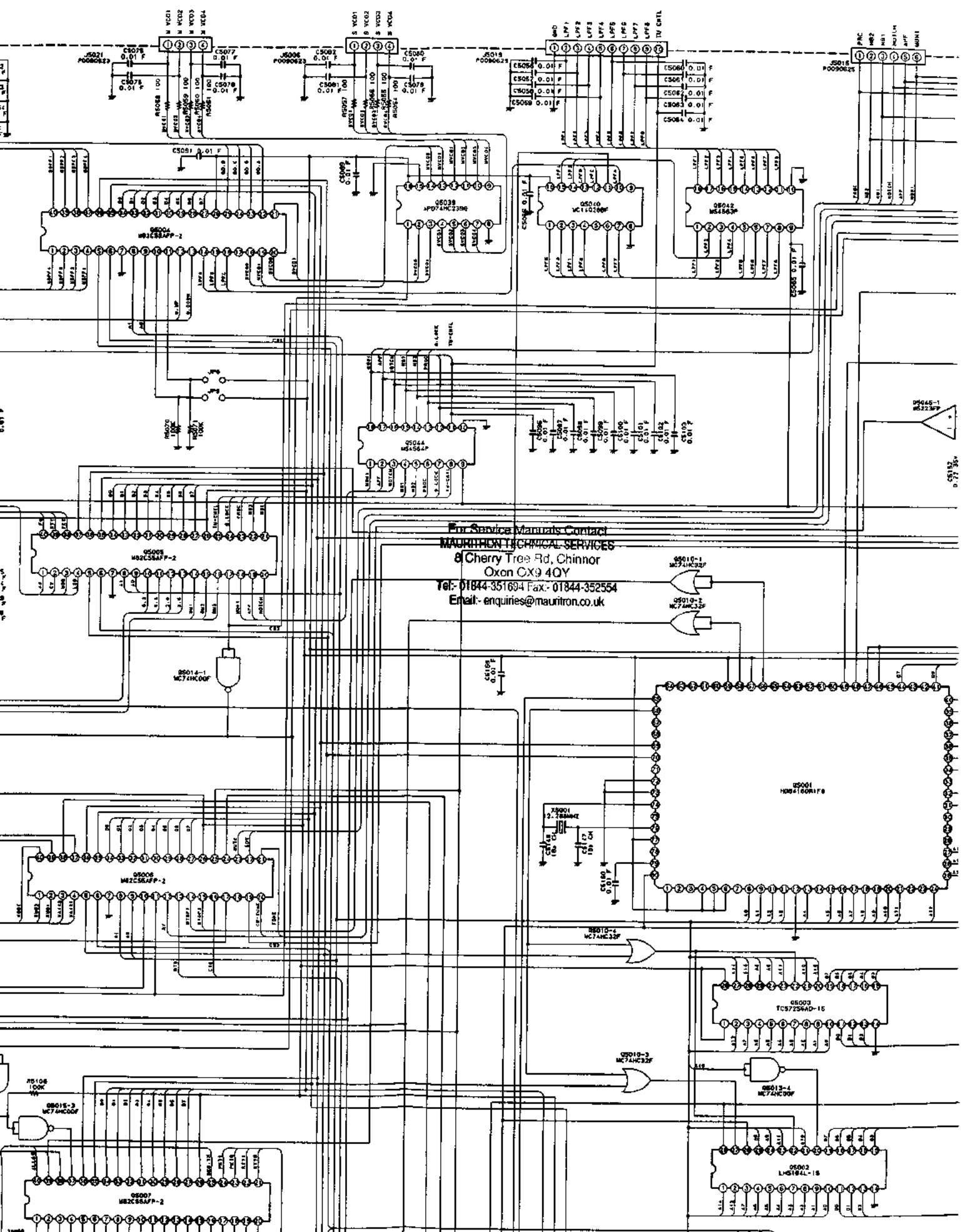

For Service Manuals Contact
MAURITRON TECHNICAL SERVICES
 of Cherry Tree Rd, Chinnor
 Oxon OX9 4OY
 Tel: 01844-351694 Fax: 01844-352554
 Email: enquiries@mauritron.co.uk

CS132 0.77 350

DS045-1
MS2230P

DS001
H082160R1F8

DS003
TC97256AD-15

DS012-1
MC74HC00P

DS002
L-6194L-15

DS014-1
MC74HC00P

DS006
M02255AJP-2

DS007
M02255AJP-2

DS038
JP074HC2396

DS044
MC4567P

DS040
MC110290P

DS042
MS1863P

DS071
M02255AJP-2

DS072
M02255AJP-2

DS073
M02255AJP-2

DS074
M02255AJP-2

DS075
M02255AJP-2

DS076
M02255AJP-2

DS077
M02255AJP-2

DS078
M02255AJP-2

DS079
M02255AJP-2

DS080
M02255AJP-2

DS081
M02255AJP-2

DS082
M02255AJP-2

DS083
M02255AJP-2

DS084
M02255AJP-2

DS085
M02255AJP-2

DS086
M02255AJP-2

DS087
M02255AJP-2

DS088
M02255AJP-2

DS089
M02255AJP-2

DS090
M02255AJP-2

DS091
M02255AJP-2

DS092
M02255AJP-2

DS093
M02255AJP-2

DS094
M02255AJP-2

DS095
M02255AJP-2

DS096
M02255AJP-2

DS097
M02255AJP-2

DS098
M02255AJP-2

DS099
M02255AJP-2

DS100
M02255AJP-2

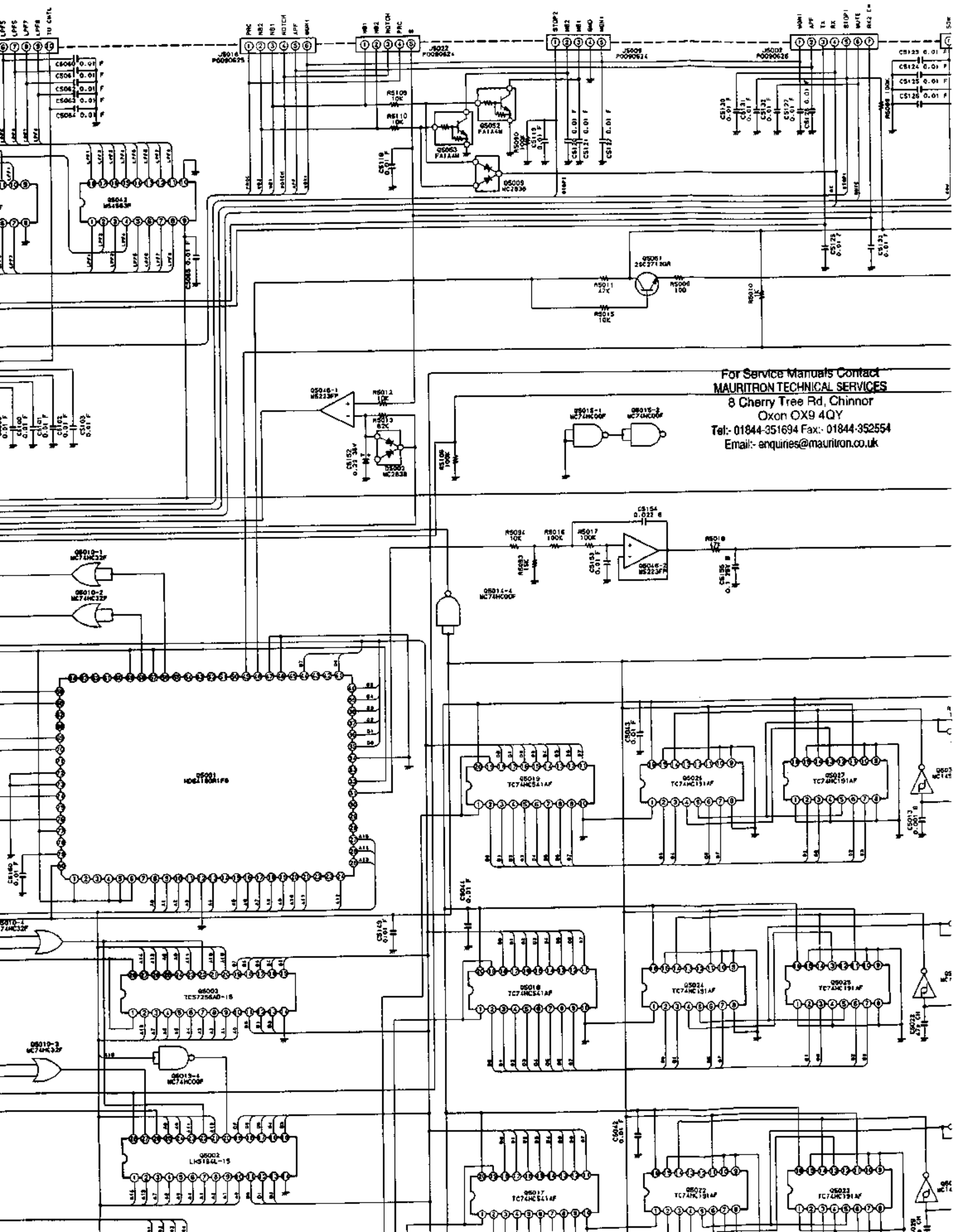

For Service Manuals Contact
MAURITRON TECHNICAL SERVICES
 8 Cherry Tree Rd, Chinnor
 Oxon OX9 4QY
 Tel: 01844-351694 Fax: 01844-352554
 Email: enquiries@mauritron.co.uk

Control Unit Board Layout

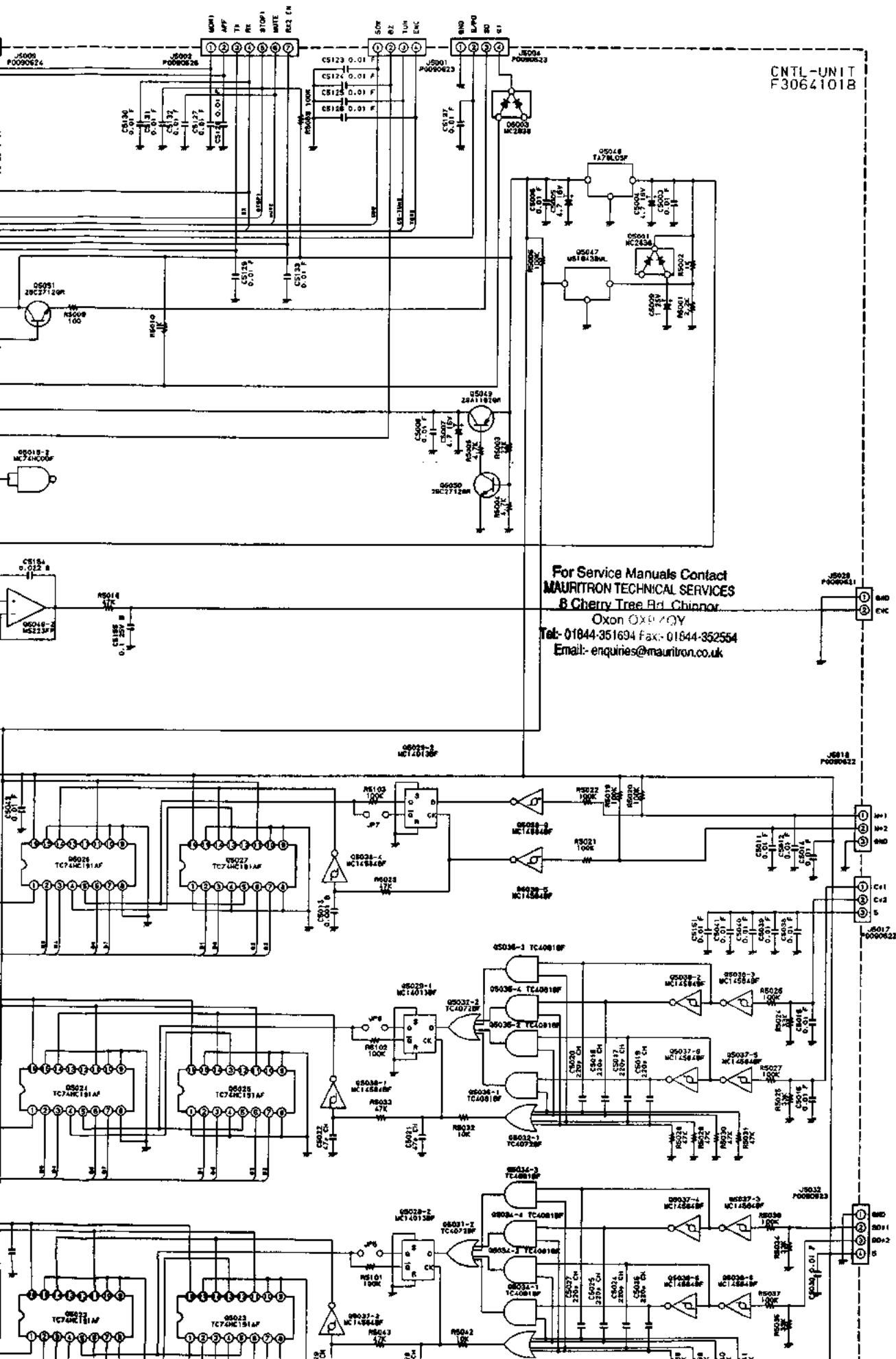

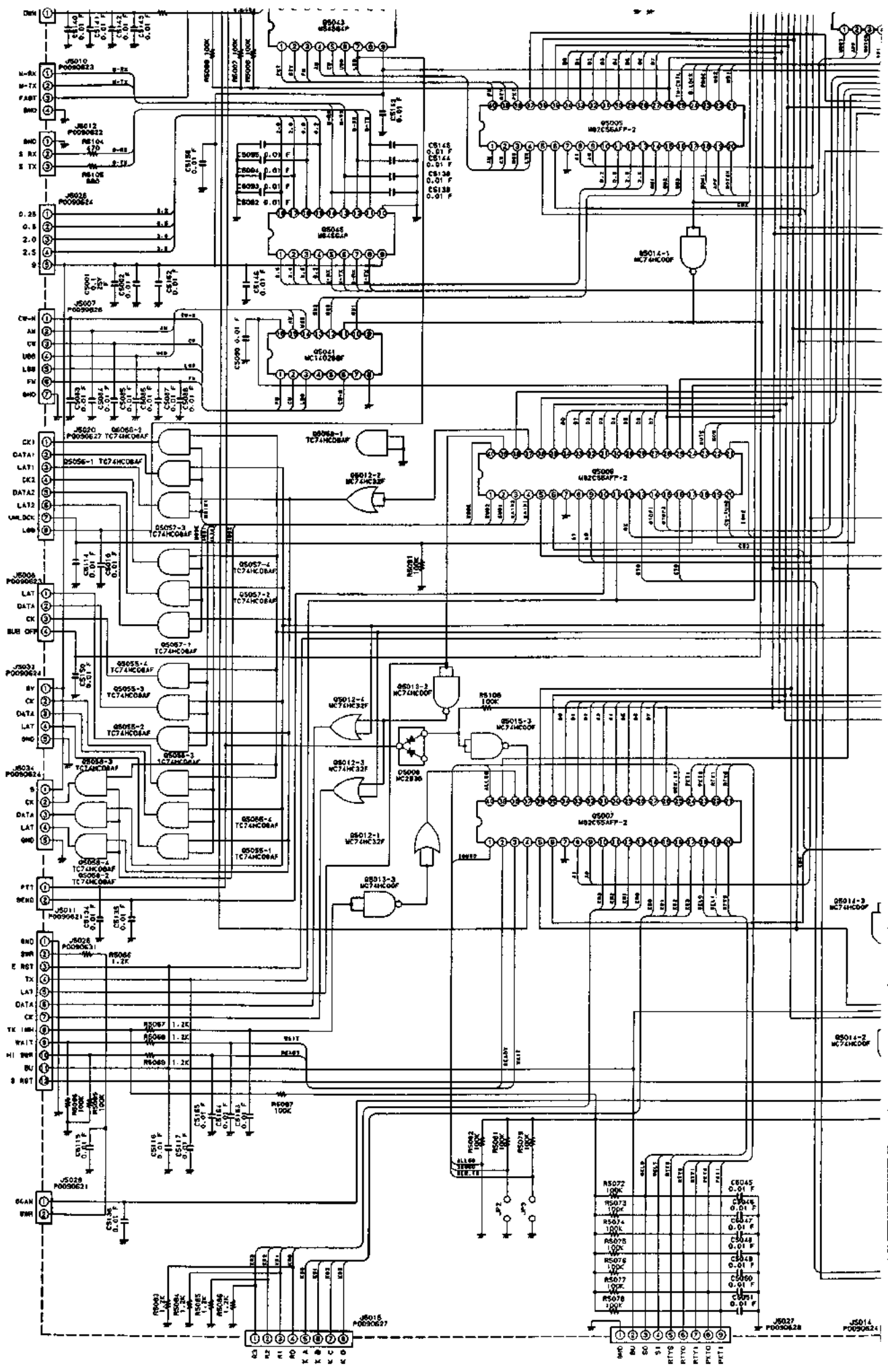

R5072	100K	C5045	0.01 F
R5073	100K	C5046	0.01 F
R5074	100K	C5047	0.01 F
R5075	100K	C5048	0.01 F
R5076	100K	C5049	0.01 F
R5077	100K	C5050	0.01 F
R5078	100K	C5051	0.01 F
R5079	100K	C5052	0.01 F
R5080	100K	C5053	0.01 F
R5081	100K	C5054	0.01 F
R5082	100K	C5055	0.01 F
R5083	100K	C5056	0.01 F
R5084	100K	C5057	0.01 F
R5085	100K	C5058	0.01 F
R5086	100K	C5059	0.01 F
R5087	100K	C5060	0.01 F
R5088	100K	C5061	0.01 F
R5089	100K	C5062	0.01 F
R5090	100K	C5063	0.01 F
R5091	100K	C5064	0.01 F
R5092	100K	C5065	0.01 F
R5093	100K	C5066	0.01 F
R5094	100K	C5067	0.01 F
R5095	100K	C5068	0.01 F
R5096	100K	C5069	0.01 F
R5097	100K	C5070	0.01 F
R5098	100K	C5071	0.01 F
R5099	100K	C5072	0.01 F
R5100	100K	C5073	0.01 F



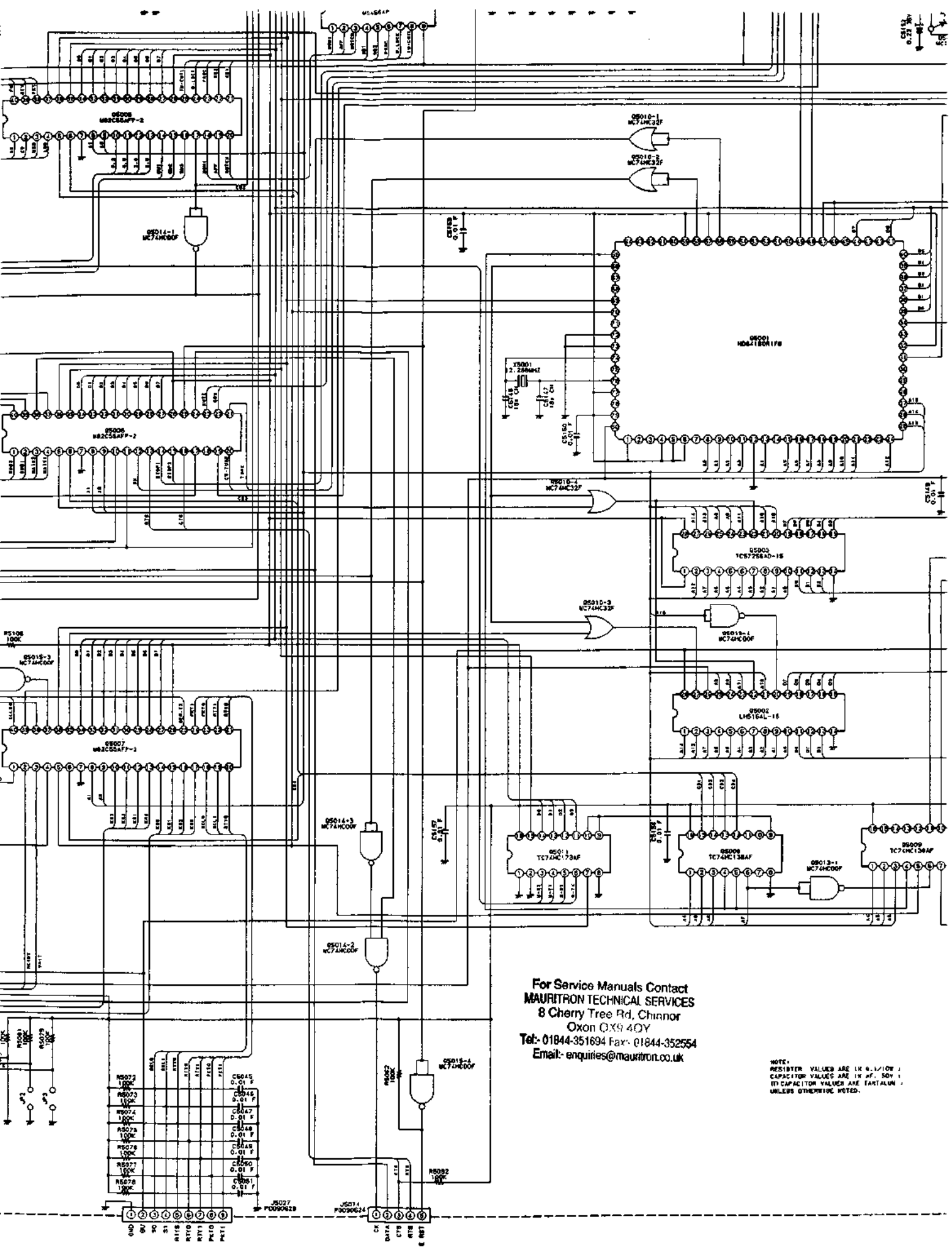

CH12
0.22 5V

For Service Manuals Contact
MAURITRON TECHNICAL SERVICES
 8 Cherry Tree Rd, Chinnor
 Oxon OX9 4QY
 Tel: 01844-351694 Fax: 01844-352554
 Email: enquiries@mauritron.co.uk

NOTE:
 RESISTOR VALUES ARE IN K (K) / 10³ /
 CAPACITOR VALUES ARE IN PF, 50V /
 IF CAPACITOR VALUES ARE TAKEN IN /
 UNLESS OTHERWISE NOTED.

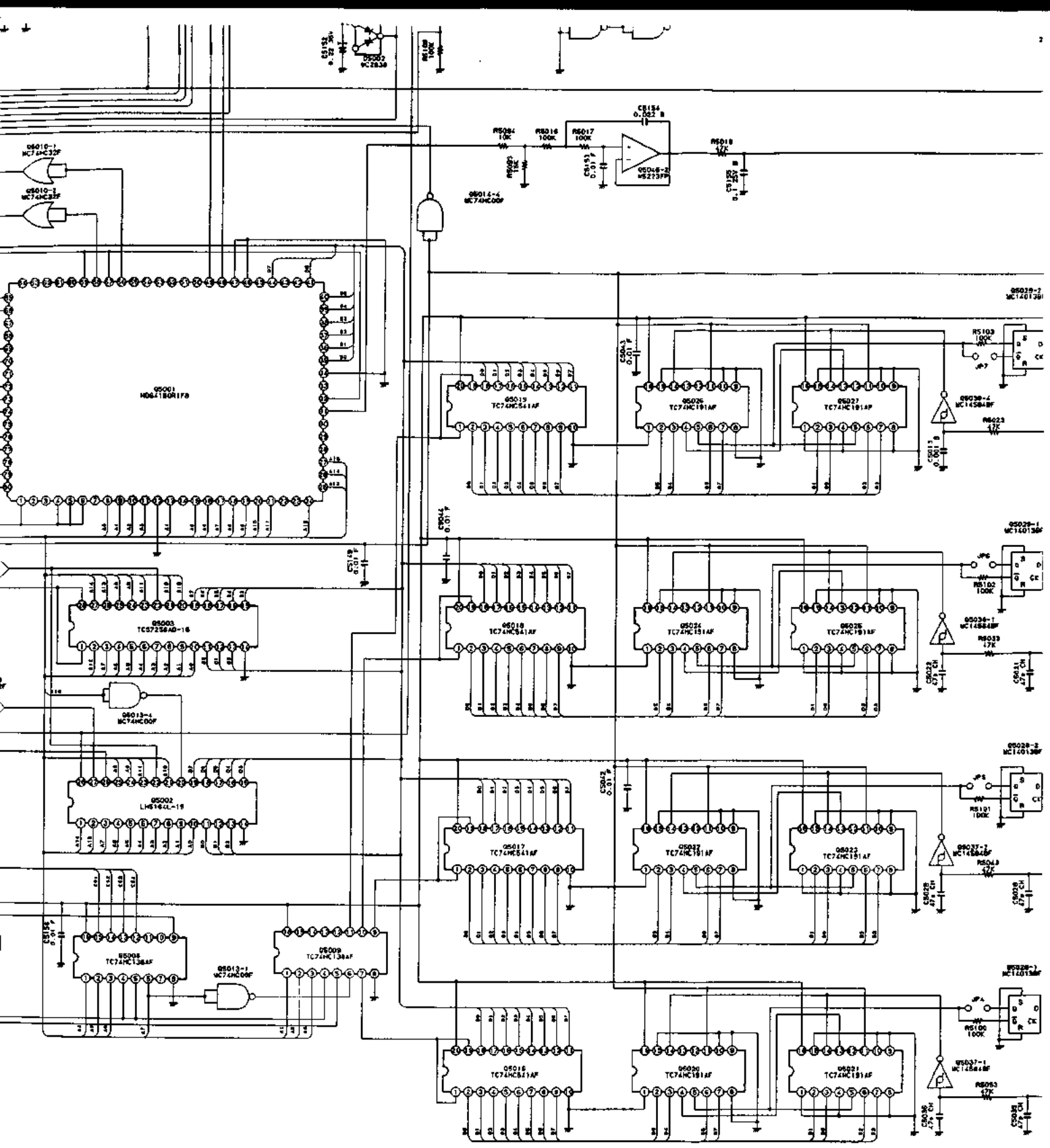

NOTE:
 RESISTOR VALUES ARE IN Ω, 1/10Ω ;
 CAPACITOR VALUES ARE IN pF, 50V ;
 (T) CAPACITOR VALUES ARE TANTALUM ;
 UNLESS OTHERWISE NOTED.

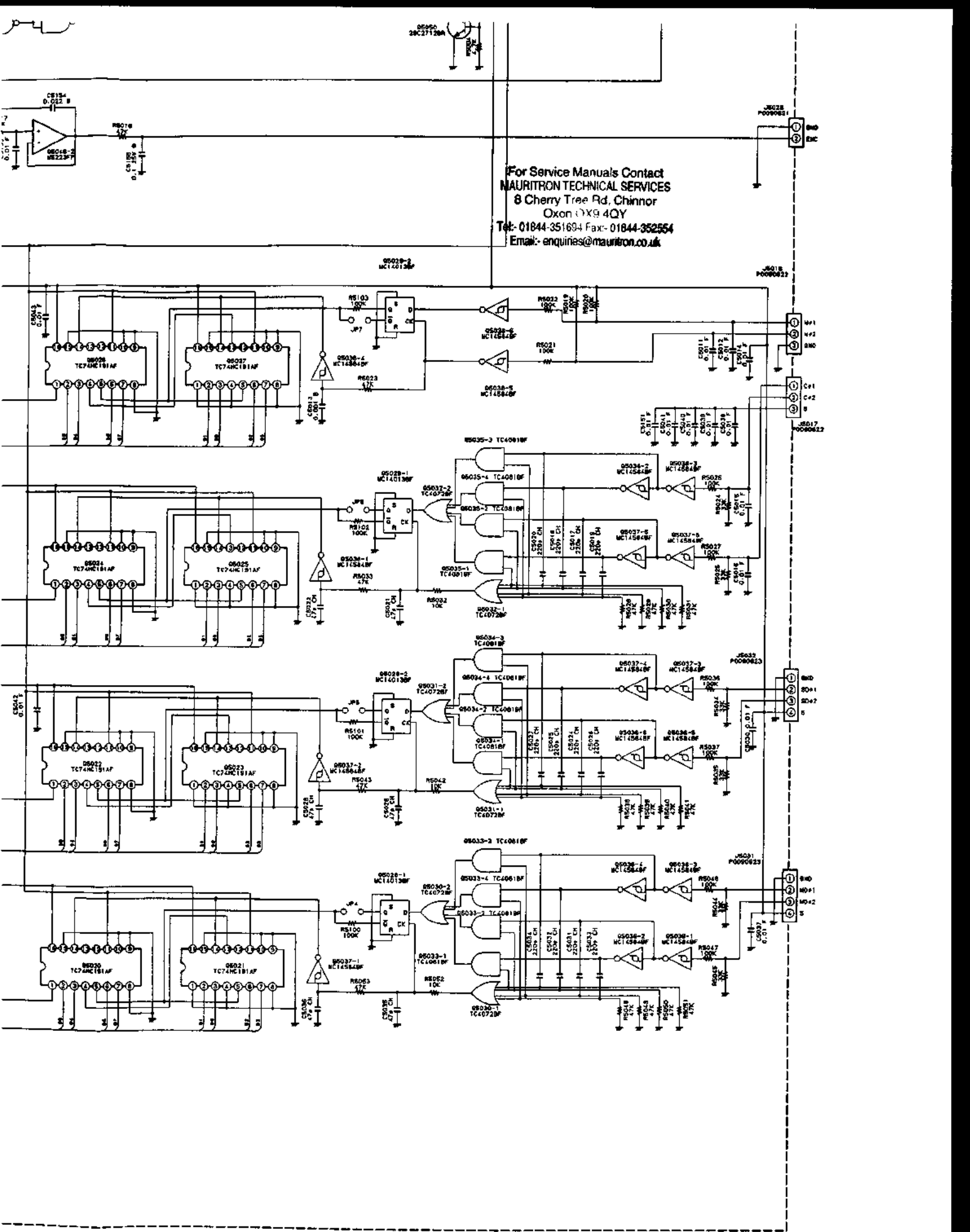

For Service Manuals Contact
MAURITRON TECHNICAL SERVICES
 8 Cherry Tree Rd, Chinnor
 Oxon OX9 4QY
 Tel: 01844-351694 Fax: 01844-352554
 Email: enquiries@mauritron.co.uk

RX-2 Unit Parts List

ADD	CODE NO	DESCRIPTION	DEVICE	TYP VAL	
** UNIT NAME : RX2-UNIT					
C 6001	K02175180	CERAMIC CAP.	DD104CH180J50	18pF	50V CH
C 6002	K02173100	CERAMIC CAP.	DD104CH100D50	10pF	50V CH
C 6003	K02179015	CERAMIC CAP.	DD106CH430J50	43p	50V CH
C 6004	K02172050	CERAMIC CAP.	DD104CH050C50	5pF	50V CH
C 6005	K02175470	CERAMIC CAP.	DD106CH470J50	47pF	50V CH
C 6006	K02172020	CERAMIC CAP.	DD104CK020C50	2pF	50V CK
C 6007	K02175270	CERAMIC CAP.	DD105CH270J50	27pF	50V CH
C 6008	K22170817	CHIP CAP.	GRM40B103M50PT	0.01uF	50V B
C 6009	K22170817	CHIP CAP.	GRM40B103M50PT	0.01uF	50V B
C 6010	K22141808	CHIP CAP.	GRM42-6B473M25PT	0.047uF	25V B
C 6011	K46170030	AL. ELECTRO. CAP.	50V010M4X7TR2	1uF	50V
C 6012	K22141808	CHIP CAP.	GRM42-6B473M25PT	0.047uF	25V B
C 6013	K46120004	AL. ELECTRO. CAP.	16V100M4X7TR2	10uF	16V
C 6014	K22170221	CHIP CAP.	GRM40CH270J50PT	27pF	50V CH
C 6015	K22170219	CHIP CAP.	GRM40CH220J50PT	22pF	50V CH
C 6016	K22170204	CHIP CAP.	GRM40CJ030C50PT	3pF	50V CJ
C 6017	K22141808	CHIP CAP.	GRM42-6B473M25PT	0.047uF	25V B
C 6018	K22141808	CHIP CAP.	GRM42-6B473M25PT	0.047uF	25V B
C 6019	K22170817	CHIP CAP.	GRM40B103M50PT	0.01uF	50V B
C 6020	K22170817	CHIP CAP.	GRM40B103M50PT	0.01uF	50V B
C 6021	K22170225	CHIP CAP.	GRM40CH390J50PT	39pF	50V CH
C 6022	K22170223	CHIP CAP.	GRM40CH330J50PT	33pF	50V CH
C 6023	K22170817	CHIP CAP.	GRM40B103M50PT	0.01uF	50V B
C 6024	K22170817	CHIP CAP.	GRM40B103M50PT	0.01uF	50V B
C 6025	K22141808	CHIP CAP.	GRM42-6B473M25PT	0.047uF	25V B
C 6026	K22170221	CHIP CAP.	GRM40CH270J50PT	27pF	50V CH
C 6027	K22170233	CHIP CAP.	GRM40CH820J50PT	82pF	50V CH
C 6028	K22170208	CHIP CAP.	GRM40CH070D50PT	7pF	50V CH
C 6029	K22170817	CHIP CAP.	GRM40B103M50PT	0.01uF	50V B
C 6030	K22170817	CHIP CAP.	GRM40B103M50PT	0.01uF	50V B
C 6031	K46120004	AL. ELECTRO. CAP.	16V100M4X7TR2	10uF	16V
C 6032	K22170817	CHIP CAP.	GRM40B103M50PT	0.01uF	50V B
C 6033	K22170221	CHIP CAP.	GRM40CH270J50PT	27pF	50V CH
C 6034	K22170817	CHIP CAP.	GRM40B103M50PT	0.01uF	50V B
C 6035	K22170817	CHIP CAP.	GRM40B103M50PT	0.01uF	50V B
C 6036	K22141808	CHIP CAP.	GRM42-6B473M25PT	0.047uF	25V B
C 6037	K22170237	CHIP CAP.	GRM40CH121J50PT	120pF	50V CH
C 6038	K22141809	CHIP CAP.	GRM42-6B104M25PT	0.1uF	25V B
C 6039	K22141809	CHIP CAP.	GRM42-6B104M25PT	0.1uF	25V B
C 6040	K22141809	CHIP CAP.	GRM42-6B104M25PT	0.1uF	25V B
C 6041	K22170817	CHIP CAP.	GRM40B103M50PT	0.01uF	50V B
C 6042	K22141809	CHIP CAP.	GRM42-6B104M25PT	0.1uF	25V B
C 6043	K22141809	CHIP CAP.	GRM42-6B104M25PT	0.1uF	25V B
C 6044	K22170817	CHIP CAP.	GRM40B103M50PT	0.01uF	50V B
C 6045	K22141809	CHIP CAP.	GRM42-6B104M25PT	0.1uF	25V B
C 6046	K22170237	CHIP CAP.	GRM40CH121J50PT	120pF	50V CH
C 6047	K22141809	CHIP CAP.	GRM42-6B104M25PT	0.1uF	25V B
C 6048	K22141809	CHIP CAP.	GRM42-6B104M25PT	0.1uF	25V B
C 6049	K22170235	CHIP CAP.	GRM40CH101J50PT	100pF	50V CH
C 6050	K22170805	CHIP CAP.	GRM40B102M50PT	0.001uF	50V B
C 6051	K22141809	CHIP CAP.	GRM42-6B104M25PT	0.1uF	25V B
C 6052	K22141809	CHIP CAP.	GRM42-6B104M25PT	0.1uF	25V B
C 6053	K22170817	CHIP CAP.	GRM40B103M50PT	0.01uF	50V B
C 6054	K22170805	CHIP CAP.	GRM40B102M50PT	0.001uF	50V B
C 6055	K22141809	CHIP CAP.	GRM42-6B104M25PT	0.1uF	25V B
C 6056	K22141809	CHIP CAP.	GRM42-6B104M25PT	0.1uF	25V B
C 6057	K22170805	CHIP CAP.	GRM40B102M50PT	0.001uF	50V B
C 6058	K22141809	CHIP CAP.	GRM42-6B104M25PT	0.1uF	25V B
C 6059	K22141809	CHIP CAP.	GRM42-6B104M25PT	0.1uF	25V B
C 6060	K22170235	CHIP CAP.	GRM40CH101J50PT	100pF	50V CH
C 6061	K22170245	CHIP CAP.	GRM40CH271J50PT	270pF	50V CH
C 6062	K46170029	AL. ELECTRO. CAP.	50VR47M4X7TR2	0.47uF	50V
C 6063	K22170817	CHIP CAP.	GRM40B103M50PT	0.01uF	50V B
C 6064	K22141809	CHIP CAP.	GRM42-6B104M25PT	0.1uF	25V B
C 6065	K22170817	CHIP CAP.	GRM40B103M50PT	0.01uF	50V B
C 6066	K22170235	CHIP CAP.	GRM40CH101J50PT	100pF	50V CH
C 6067	K22170805	CHIP CAP.	GRM40B102M50PT	0.001uF	50V B
C 6068	K46120007	AL. ELECTRO. CAP.	16V101M6X7TR2	100uF	16V
C 6069	K22141808	CHIP CAP.	GRM42-6B473M25PT	0.047uF	25V B
C 6070	K70167105	TANTALUM CAP.	DN1V010M1S	1uF	35V
C 6071	K46120007	AL. ELECTRO. CAP.	16V101M6X7TR2	100uF	16V
C 6072	K22141808	CHIP CAP.	GRM42-6B473M25PT	0.047uF	25V B
C 6073	K22170247	CHIP CAP.	GRM40CH331J50PT	330pF	50V CH
C 6074	K22171008	CHIP CAP.	GRM40F473Z50PT	0.047uF	50V F
C 6075	K46120004	AL. ELECTRO. CAP.	16V100M4X7TR2	10uF	16V
C 6076	K46170030	AL. ELECTRO. CAP.	50V010M4X7TR2	1uF	50V
C 6077	K22170817	CHIP CAP.	GRM40B103M50PT	0.01uF	50V B
C 6078	K22141005	CHIP CAP.	GRM40F104Z25PT	0.1uF	25V F
C 6079	K22170817	CHIP CAP.	GRM40B103M50PT	0.01uF	50V B
C 6080	K22141809	CHIP CAP.	GRM42-6B104M25PT	0.1uF	25V B
C 6081	K46120004	AL. ELECTRO. CAP.	16V100M4X7TR2	10uF	16V
C 6082	K46170030	AL. ELECTRO. CAP.	50V010M4X7TR2	1uF	50V

RX-2 Unit Parts List

ADD	CODE NO	DESCRIPTION	DEVICE	TYP	VAL
C 6083	K46120004	AL. ELECTRO. CAP.	16V100M4X7TR2	10uF	16V
C 6084	K22170821	CHIP CAP.	GRM40B223M50PT	0.022uF	50V B
C 6085	K22170821	CHIP CAP.	GRM40B223M50PT	0.022uF	50V B
C 6086	K22170805	CHIP CAP.	GRM40B102M50PT	0.001uF	50V B
C 6087	K22170805	CHIP CAP.	GRM40B102M50PT	0.001uF	50V B
C 6088	K46170030	AL. ELECTRO. CAP.	50V010M4X7TR2	1uF	50V
C 6089	K46170030	AL. ELECTRO. CAP.	50V010M4X7TR2	1uF	50V
C 6090	K46170026	AL. ELECTRO. CAP.	50VR10M4X7TR2	0.1uF	50V
C 6091	K46120004	AL. ELECTRO. CAP.	16V100M4X7TR2	10uF	16V
C 6092	K46170030	AL. ELECTRO. CAP.	50V010M4X7TR2	1uF	50V
C 6093	K22170817	CHIP CAP.	GRM40B103M50PT	0.01uF	50V B
C 6094	K22170817	CHIP CAP.	GRM40B103M50PT	0.01uF	50V B
C 6095	K22170817	CHIP CAP.	GRM40B103M50PT	0.01uF	50V B
C 6096	K22170817	CHIP CAP.	GRM40B103M50PT	0.01uF	50V B
C 6097	K22170817	CHIP CAP.	GRM40B103M50PT	0.01uF	50V B
C 6098	K22170817	CHIP CAP.	GRM40B103M50PT	0.01uF	50V B
C 6099	K22170817	CHIP CAP.	GRM40B103M50PT	0.01uF	50V B
C 6100	K22170817	CHIP CAP.	GRM40B103M50PT	0.01uF	50V B
C 6101	K22170227	CHIP CAP.	GRM40CH470J50PT	47pF	50V CH
C 6103	K22170817	CHIP CAP.	GRM40B103M50PT	0.01uF	50V B
C 6104	K22170217	CHIP CAP.	GRM40CH180J50PT	18pF	50V CH
C 6105	K22170805	CHIP CAP.	GRM40B102M50PT	0.001uF	50V B
C 6106	K46160004	AL. ELECTRO. CAP.	35V4R7M4X7TR2	4.7uF	35V
C 6107	K22170209	CHIP CAP.	GRM40CH080D50PT	8pF	50V CH
C 6109	K22170247	CHIP CAP.	GRM40CH331J50PT	330pF	50V CH
C 6110	K22170805	CHIP CAP.	GRM40B102M50PT	0.001uF	50V B
C 6111	K46120007	AL. ELECTRO. CAP.	16V101M6X7TR2	100uF	16V
C 6112	K22141809	CHIP CAP.	GRM42-6B104M25PT	0.1uF	25V B
C 6114	K22170817	CHIP CAP.	GRM40B103M50PT	0.01uF	50V B
C 6115	K22141809	CHIP CAP.	GRM42-6B104M25PT	0.1uF	25V B
C 6116	K46170030	AL. ELECTRO. CAP.	50V010M4X7TR2	1uF	50V
C 6117	K22170225	CHIP CAP.	GRM40CH390J50PT	39pF	50V CH
C 6118	K22170225	CHIP CAP.	GRM40CH390J50PT	39pF	50V CH
C 6119	K22170225	CHIP CAP.	GRM40CH390J50PT	39pF	50V CH
C 6120	K22170245	CHIP CAP.	GRM40CH271J50PT	270pF	50V CH
C 6121	K22170245	CHIP CAP.	GRM40CH271J50PT	270pF	50V CH
C 6122	K22170817	CHIP CAP.	GRM40B103M50PT	0.01uF	50V B
C 6123	K22170219	CHIP CAP.	GRM40CH220J50PT	22pF	50V CH
C 6124	K22170817	CHIP CAP.	GRM40B103M50PT	0.01uF	50V B
C 6125	K22170817	CHIP CAP.	GRM40B103M50PT	0.01uF	50V B
C 6126	K46120006	AL. ELECTRO. CAP.	16V470M6X7TR2	47uF	16V
C 6127	K22170221	CHIP CAP.	GRM40CH270J50PT	27pF	50V CH
C 6128	K22170817	CHIP CAP.	GRM40B103M50PT	0.01uF	50V B
C 6129	K22170817	CHIP CAP.	GRM40B103M50PT	0.01uF	50V B
C 6130	K22170805	CHIP CAP.	GRM40B102M50PT	0.001uF	50V B
C 6131	K22170221	CHIP CAP.	GRM40CH270J50PT	27pF	50V CH
C 6132	K22170215	CHIP CAP.	GRM40CH150J50PT	15pF	50V CH
C 6133	K22141808	CHIP CAP.	GRM42-6B473M25PT	0.047uF	25V B
C 6134	K22170221	CHIP CAP.	GRM40CH270J50PT	27pF	50V CH
C 6135	K22141809	CHIP CAP.	GRM42-6B104M25PT	0.1uF	25V B
C 6136	K22170821	CHIP CAP.	GRM40B223M50PT	0.022uF	50V B
C 6137	K22170821	CHIP CAP.	GRM40B223M50PT	0.022uF	50V B
C 6138	K22170802	CHIP CAP.	GRM40B561M50PT	560pF	50V B
C 6139	K22170807	CHIP CAP.	GRM40B152M50PT	0.0015	50V B
C 6140	K22170245	CHIP CAP.	GRM40CH271J50PT	270pF	50V CH
C 6141	K22170239	CHIP CAP.	GRM40CH151J50PT	150pF	50V CH
C 6142	K02179027	CERAMIC CAP.	DD112CH271J50	270pF	50V CH
C 6143	K22170239	CHIP CAP.	GRM40CH151J50PT	150pF	50V CH
C 6144	K22170805	CHIP CAP.	GRM40B102M50PT	0.001uF	50V B
C 6145	K22170211	CHIP CAP.	GRM40CH100D50PT	10pF	50V CH
C 6146	K22170817	CHIP CAP.	GRM40B103M50PT	0.01uF	50V B
C 6147	K22170817	CHIP CAP.	GRM40B103M50PT	0.01uF	50V B
C 6148	K22170821	CHIP CAP.	GRM40B223M50PT	0.022uF	50V B
C 6149	K22170225	CHIP CAP.	GRM40CH390J50PT	39pF	50V CH
C 6150	K22170203	CHIP CAP.	GRM40CK020C50PT	2pF	50V CK
C 6151	K22170805	CHIP CAP.	GRM40B102M50PT	0.001uF	50V B
C 6152	K22141808	CHIP CAP.	GRM42-6B473M25PT	0.047uF	25V B
C 6153	K46120007	AL. ELECTRO. CAP.	16V101M6X7TR2	100uF	16V
C 6154	K70167474	TANTALUM CAP.	DN1VR47M1S	0.47uF	35V
C 6155	K22170821	CHIP CAP.	GRM40B223M50PT	0.022uF	50V B
C 6156	K22170245	CHIP CAP.	GRM40CH271J50PT	270pF	50V CH
C 6157	K22170251	CHIP CAP.	GRM40CH471J50PT	470pF	50V CH
C 6158	K22141808	CHIP CAP.	GRM42-6B473M25PT	0.047uF	25V B
C 6159	K22170203	CHIP CAP.	GRM40CK020C50PT	2pF	50V CK
C 6160	K22170817	CHIP CAP.	GRM40B103M50PT	0.01uF	50V B
C 6161	K22170805	CHIP CAP.	GRM40B102M50PT	0.001uF	50V B
C 6162	K22170223	CHIP CAP.	GRM40CH330J50PT	33pF	50V CH
C 6163	K22170206	CHIP CAP.	GRM40CH050C50PT	5pF	50V CH
C 6164	K22170817	CHIP CAP.	GRM40B103M50PT	0.01uF	50V B
C 6165	K22170805	CHIP CAP.	GRM40B102M50PT	0.001uF	50V B
C 6166	K22170817	CHIP CAP.	GRM40B103M50PT	0.01uF	50V B
C 6167	K22170817	CHIP CAP.	GRM40B103M50PT	0.01uF	50V B
C 6168	K22170219	CHIP CAP.	GRM40CH220J50PT	22pF	50V CH

RX-2 Unit Parts List

ADD	CODE NO	DESCRIPTION	DEVICE		TYP	VAL
C 6169	K22170805	CHIP CAP.	GRM40B102M50PT	0.001uF	50V	B
C 6170	K22170817	CHIP CAP.	GRM40B103M50PT	0.01uF	50V	B
C 6171	K22170817	CHIP CAP.	GRM40B103M50PT	0.01uF	50V	B
C 6174	K22170207	CHIP CAP.	GRM40CH060D50PT	6pF	50V	CH
C 6175	K22170805	CHIP CAP.	GRM40B102M50PT	0.001uF	50V	B
C 6176	K19149001	CERAMIC CAP.	UAT04X102K-L05AE	0.001uF	25V	X
C 6177	K22170821	CHIP CAP.	GRM40B223M50PT	0.022uF	50V	B
C 6179	K22170327	CHIP CAP.	GRM40UJ470J50PT	47pF	50V	UJ
C 6180	K22170331	CHIP CAP.	GRM40UJ680J50PT	68pF	50V	UJ
C 6181	K46120005	AL.ELECTRO.CAP.	16V220M5X7TR2	22uF	16V	
C 6182	K22170817	CHIP CAP.	GRM40B103M50PT	0.01uF	50V	B
C 6183	K22170817	CHIP CAP.	GRM40B103M50PT	0.01uF	50V	B
C 6184	K22170204	CHIP CAP.	GRM40CJ030C50PT	3pF	50V	CJ
C 6185	K22170817	CHIP CAP.	GRM40B103M50PT	0.01uF	50V	B
C 6186	K22170817	CHIP CAP.	GRM40B103M50PT	0.01uF	50V	B
C 6187	K22170215	CHIP CAP.	GRM40CH150J50PT	15pF	50V	CH
C 6188	K22170203	CHIP CAP.	GRM40CK020C50PT	2pF	50V	CK
C 6189	K22170817	CHIP CAP.	GRM40B103M50PT	0.01uF	50V	B
C 6190	K22170817	CHIP CAP.	GRM40B103M50PT	0.01uF	50V	B
C 6191	K22170227	CHIP CAP.	GRM40CH470J50PT	47pF	50V	CH
C 6192	K22141808	CHIP CAP.	GRM42-6B473M25PT	0.047uF	25V	B
C 6193	K70087106	TANTALUM CAP.	DN0J100M1S	10uF	6.3V	
C 6194	K22170817	CHIP CAP.	GRM40B103M50PT	0.01uF	50V	B
C 6195	K46120007	AL.ELECTRO.CAP.	16V101M6X7TR2	100uF	16V	
C 6196	K22141808	CHIP CAP.	GRM42-6B473M25PT	0.047uF	25V	B
C 6197	K22170817	CHIP CAP.	GRM40B103M50PT	0.01uF	50V	B
C 6198	K22170817	CHIP CAP.	GRM40B103M50PT	0.01uF	50V	B
C 6199	K22170211	CHIP CAP.	GRM40CH100D50PT	10pF	50V	CH
C 6200	K22141808	CHIP CAP.	GRM42-6B473M25PT	0.047uF	25V	B
C 6201	K22141808	CHIP CAP.	GRM42-6B473M25PT	0.047uF	25V	B
C 6202	K22170802	CHIP CAP.	GRM40B561M50PT	560pF	50V	B
C 6203	K22170802	CHIP CAP.	GRM40B561M50PT	560pF	50V	B
C 6206	K22171008	CHIP CAP.	GRM40F473Z50PT	0.047uF	50V	F
C 6207	K22170817	CHIP CAP.	GRM40B103M50PT	0.01uF	50V	B
C 6208	K22171008	CHIP CAP.	GRM40F473Z50PT	0.047uF	50V	F
C 6209	K22141809	CHIP CAP.	GRM42-6B104M25PT	0.1uF	25V	B
C 6210	K46120004	AL.ELECTRO.CAP.	16V100M4X7TR2	10uF	16V	
C 6211	K22141809	CHIP CAP.	GRM42-6B104M25PT	0.1uF	25V	B
C 6212	K46120007	AL.ELECTRO.CAP.	16V101M6X7TR2	100uF	16V	
C 6213	K22141809	CHIP CAP.	GRM42-6B104M25PT	0.1uF	25V	B
C 6214	K70167224	TANTALUM CAP.	DN1VR22M1S	0.22uF	35V	
C 6215	K22141809	CHIP CAP.	GRM42-6B104M25PT	0.1uF	25V	B
C 6216	K22170310	CHIP CAP.	GRM40UJ090D50PT	9pF	50V	UJ
C 6217	K22170219	CHIP CAP.	GRM40CH220J50PT	22pF	50V	CH
C 6218	K22170211	CHIP CAP.	GRM40CH100D50PT	10pF	50V	CH
C 6219	K22170327	CHIP CAP.	GRM40UJ470J50PT	47pF	50V	UJ
C 6220	K22170311	CHIP CAP.	GRM40UJ100D50PT	10pF	50V	UJ
C 6221	K22170202	CHIP CAP.	GRM40CK010C50PT	1pF	50V	CK
C 6222	K22170817	CHIP CAP.	GRM40B103M50PT	0.01uF	50V	B
C 6223	K46120007	AL.ELECTRO.CAP.	16V101M6X7TR2	100uF	16V	
C 6224	K22170817	CHIP CAP.	GRM40B103M50PT	0.01uF	50V	B
C 6225	K22170203	CHIP CAP.	GRM40CK020C50PT	2pF	50V	CK
C 6226	K22170817	CHIP CAP.	GRM40B103M50PT	0.01uF	50V	B
C 6227	K22170817	CHIP CAP.	GRM40B103M50PT	0.01uF	50V	B
C 6228	K22170203	CHIP CAP.	GRM40CK020C50PT	2pF	50V	CK
C 6229	K22170817	CHIP CAP.	GRM40B103M50PT	0.01uF	50V	B
C 6230	K22170817	CHIP CAP.	GRM40B103M50PT	0.01uF	50V	B
C 6231	K22170817	CHIP CAP.	GRM40B103M50PT	0.01uF	50V	B
C 6232	K22141809	CHIP CAP.	GRM42-6B104M25PT	0.1uF	25V	B
C 6233	K22141809	CHIP CAP.	GRM42-6B104M25PT	0.1uF	25V	B
C 6234	K22141809	CHIP CAP.	GRM42-6B104M25PT	0.1uF	25V	B
C 6236	K22170233	CHIP CAP.	GRM40CH820J50PT	82pF	50V	CH
C 6237	K22170249	CHIP CAP.	GRM40CH391J50PT	390pF	50V	CH
C 6238	K22170251	CHIP CAP.	GRM40CH471J50PT	470pF	50V	CH
C 6239	K22170817	CHIP CAP.	GRM40B103M50PT	0.01uF	50V	B
C 6240	K22141808	CHIP CAP.	GRM42-6B473M25PT	0.047uF	25V	B
C 6241	K22120805	CHIP CAP.	GRM40R683M16PT	0.068uF	16V	R
C 6244	K22170805	CHIP CAP.	GRM40B102M50PT	0.001uF	50V	B
C 6245	K22170817	CHIP CAP.	GRM40B103M50PT	0.01uF	50V	B
C 6246	K22170817	CHIP CAP.	GRM40B103M50PT	0.01uF	50V	B
C 6247	K22170817	CHIP CAP.	GRM40B103M50PT	0.01uF	50V	B
C 6248	K22170201	CHIP CAP.	GRM40CK0R5C50PT	0.5pF	50V	CK
C 6249	K22170817	CHIP CAP.	GRM40B103M50PT	0.01uF	50V	B
C 6250	K22170227	CHIP CAP.	GRM40CH470J50PT	47pF	50V	CH
C 6251	K22170817	CHIP CAP.	GRM40B103M50PT	0.01uF	50V	B
C 6252	K22170817	CHIP CAP.	GRM40B103M50PT	0.01uF	50V	B
C 6253	K22170805	CHIP CAP.	GRM40B102M50PT	0.001uF	50V	B
C 6254	K22170805	CHIP CAP.	GRM40B102M50PT	0.001uF	50V	B
C 6255	K22170805	CHIP CAP.	GRM40B102M50PT	0.001uF	50V	B
C 6256	K22170805	CHIP CAP.	GRM40B102M50PT	0.001uF	50V	B
C 6257	K22170239	CHIP CAP.	GRM40CH151J50PT	150pF	50V	CH
C 6258	K22170209	CHIP CAP.	GRM40CH080D50PT	8pF	50V	CH
C 6259	K22170231	CHIP CAP.	GRM40CH680J50PT	68pF	50V	CH

For Service Manuals Contact
MAURITRON TECHNICAL SERVICES
 8 Cherry Tree Rd. Chinnor
 Oxon OX9 4DQ
 Tel: 01844-351634 Fax: 01844-352654
 Email: enquiries@mauritron.co.uk

RX-2 Unit Parts List

ADD	CODE NO	DESCRIPTION	DEVICE	TYP	VAL
C 6260	K22170227	CHIP CAP.	GRM40CH470J50PT	47pF	50V CH
C 6261	K22170211	CHIP CAP.	GRM40CH100D50PT	10pF	50V CH
C 6262	K22170817	CHIP CAP.	GRM40B103M50PT	0.01uF	50V B
C 6263	K46120007	AL. ELECTRO. CAP.	16V101M6X7TR2	100uF	16V
C 6264	K22170225	CHIP CAP.	GRM40CH390J50PT	39pF	50V CH
C 6265	K22170205	CHIP CAP.	GRM40CH040C50PT	4pF	50V CH
C 6266	K22170231	CHIP CAP.	GRM40CH680J50PT	68pF	50V CH
C 6267	K22170221	CHIP CAP.	GRM40CH270J50PT	27pF	50V CH
C 6268	K22170211	CHIP CAP.	GRM40CH100D50PT	10pF	50V CH
C 6269	K22170817	CHIP CAP.	GRM40B103M50PT	0.01uF	50V B
C 6270	K46120007	AL. ELECTRO. CAP.	16V101M6X7TR2	100uF	16V
C 6271	K22170221	CHIP CAP.	GRM40CH270J50PT	27pF	50V CH
C 6272	K22170204	CHIP CAP.	GRM40CJ030C50PT	3pF	50V CJ
C 6273	K22170231	CHIP CAP.	GRM40CH680J50PT	68pF	50V CH
C 6274	K22170223	CHIP CAP.	GRM40CH330J50PT	33pF	50V CH
C 6275	K22170211	CHIP CAP.	GRM40CH100D50PT	10pF	50V CH
C 6276	K22170817	CHIP CAP.	GRM40B103M50PT	0.01uF	50V B
C 6277	K46120007	AL. ELECTRO. CAP.	16V101M6X7TR2	100uF	16V
C 6278	K22170221	CHIP CAP.	GRM40CH270J50PT	27pF	50V CH
C 6279	K22170205	CHIP CAP.	GRM40CH040C50PT	4pF	50V CH
C 6280	K22170231	CHIP CAP.	GRM40CH680J50PT	68pF	50V CH
C 6281	K22170221	CHIP CAP.	GRM40CH270J50PT	27pF	50V CH
C 6282	K22170211	CHIP CAP.	GRM40CH100D50PT	10pF	50V CH
C 6283	K22170817	CHIP CAP.	GRM40B103M50PT	0.01uF	50V B
C 6284	K46120007	AL. ELECTRO. CAP.	16V101M6X7TR2	100uF	16V
C 6285	K22170817	CHIP CAP.	GRM40B103M50PT	0.01uF	50V B
C 6286	K46120006	AL. ELECTRO. CAP.	16V470M6X7TR2	47uF	16V
C 6287	K22170202	CHIP CAP.	GRM40CK010C50PT	1pF	50V CK
C 6288	K22170817	CHIP CAP.	GRM40B103M50PT	0.01uF	50V B
C 6289	K22170202	CHIP CAP.	GRM40CK010C50PT	1pF	50V CK
C 6290	K22170817	CHIP CAP.	GRM40B103M50PT	0.01uF	50V B
C 6291	K22170805	CHIP CAP.	GRM40B102M50PT	0.001uF	50V B
C 6292	K22170203	CHIP CAP.	GRM40CK020C50PT	2pF	50V CK
C 6293	K22170202	CHIP CAP.	GRM40CK010C50PT	1pF	50V CK
C 6294	K22141808	CHIP CAP.	GRM42-6B473M25PT	0.047uF	25V B
C 6295	K22170817	CHIP CAP.	GRM40B103M50PT	0.01uF	50V B
C 6296	K22170817	CHIP CAP.	GRM40B103M50PT	0.01uF	50V B
C 6297	K22141808	CHIP CAP.	GRM42-6B473M25PT	0.047uF	25V B
C 6298	K02173080	CERAMIC CAP.	DD104CH080D50	8pF	50V CH
C 6299	K02172030	CERAMIC CAP.	DD104CJ030C50	3pF	50V CJ
C 6300	K02179010	CERAMIC CAP.	DD104CH240J50	24p	50V CH
C 6301	K02173080	CERAMIC CAP.	DD104CH080D50	8pF	50V CH
C 6302	K02179009	CERAMIC CAP.	DD104CH220J50	22pF	50V CH
C 6303	K02173090	CERAMIC CAP.	DD104CH090D50	9pF	50V CH
C 6304	K02179009	CERAMIC CAP.	DD104CH220J50	22pF	50V CH
C 6305	K02172050	CERAMIC CAP.	DD104CH050C50	5pF	50V CH
C 6306	K02175270	CERAMIC CAP.	DD105CH270J50	27pF	50V CH
C 6307	K02172059	CERAMIC CAP.	DD104CK0R5C50	0.5pF	50V CK
C 6308	K02175120	CERAMIC CAP.	DD104CH120J50	12pF	50V CH
C 6309	K22170817	CHIP CAP.	GRM40B103M50PT	0.01uF	50V B
C 6311	K22141808	CHIP CAP.	GRM42-6B473M25PT	0.047uF	25V B
C 6312	K22170817	CHIP CAP.	GRM40B103M50PT	0.01uF	50V B
C 6313	K46120005	AL. ELECTRO. CAP.	16V220M5X7TR2	22uF	16V
C 6314	K22170821	CHIP CAP.	GRM40B223M50PT	0.022uF	50V B
C 6315	K22170817	CHIP CAP.	GRM40B103M50PT	0.01uF	50V B
C 6316	K22170817	CHIP CAP.	GRM40B103M50PT	0.01uF	50V B
C 6317	K22170817	CHIP CAP.	GRM40B103M50PT	0.01uF	50V B
C 6318	K22170817	CHIP CAP.	GRM40B103M50PT	0.01uF	50V B
C 6319	K46120007	AL. ELECTRO. CAP.	16V101M6X7TR2	100uF	16V
C 6320	K70167334	TANTALUM CAP.	DN1VR33M1S	0.33uF	35V
C 6321	K22171008	CHIP CAP.	GRM40F473Z50PT	0.047uF	50V F
C 6322	K19149013	CERAMIC CAP.	UAT05X103K-L05AE	0.01uF	25V X
C 6324	K22170206	CHIP CAP.	GRM40CH050C50PT	5pF	50V CH
C 6325	K22170817	CHIP CAP.	GRM40B103M50PT	0.01uF	50V B
C 6326	K22170805	CHIP CAP.	GRM40B102M50PT	0.001uF	50V B
C 6327	K22170817	CHIP CAP.	GRM40B103M50PT	0.01uF	50V B
C 6328	K22170805	CHIP CAP.	GRM40B102M50PT	0.001uF	50V B
C 6329	K22170817	CHIP CAP.	GRM40B103M50PT	0.01uF	50V B
C 6330	K22170817	CHIP CAP.	GRM40B103M50PT	0.01uF	50V B
C 6331	K46120004	AL. ELECTRO. CAP.	16V100M4X7TR2	10uF	16V
C 6332	K22170817	CHIP CAP.	GRM40B103M50PT	0.01uF	50V B
C 6333	K22170231	CHIP CAP.	GRM40C4680J50PT	68pF	50V CH
C 6334	K02175101	CERAMIC CAP.	DD107CH101J50	100pF	50V CH
C 6335	K22170219	CHIP CAP.	GRM40CH220J50PT	22pF	50V CH
C 6336	K02175390	CERAMIC CAP.	DD105-257CH390J50	39pF	50V CH
C 6337	K22170209	CHIP CAP.	GRM40CH080D50PT	8pF	50V CH
C 6338	K22170817	CHIP CAP.	GRM40B103M50PT	0.01uF	50V B
C 6339	K22170817	CHIP CAP.	GRM40B103M50PT	0.01uF	50V B
C 6340	K46170030	AL. ELECTRO. CAP.	50V010M4X7TR2	1uF	50V
C 6341	K70167104	TANTALUM CAP.	DN1V0R1M1S	0.1uF	35V
C 6342	K46120007	AL. ELECTRO. CAP.	16V101M6X7TR2	100uF	16V
C 6343	K22141808	CHIP CAP.	GRM42-6B473M25PT	0.047uF	25V B
C 6346	K46120004	AL. ELECTRO. CAP.	16V100M4X7TR2	10uF	16V

RX-2 Unit Parts List

ADD	CODE NO	DESCRIPTION	DEVICE	TYP	VAL
C 6347	K22170821	CHIP CAP.	GRM40B223M50PT	0.022uF	50V B
C 6348	K22141809	CHIP CAP.	GRM42-6B104M25PT	0.1uF	25V B
C 6349	K46120004	AL. ELECTRO. CAP.	16V100M4X7TR2	10uF	16V
C 6350	K22170817	CHIP CAP.	GRM40B103M50PT	0.01uF	50V B
C 6354	K22170817	CHIP CAP.	GRM40B103M50PT	0.01uF	50V B
C 6355	K22170805	CHIP CAP.	GRM40B102M50PT	0.001uF	50V B
C 6356	K22170319	CHIP CAP.	GRM40UJ220J50PT	22pF	50V UJ
C 6357	K22170327	CHIP CAP.	GRM40UJ470J50PT	47pF	50V UJ
C 6358	K22141809	CHIP CAP.	GRM42-6B104M25PT	0.1uF	25V B
C 6359	K22141809	CHIP CAP.	GRM42-6B104M25PT	0.1uF	25V B
C 6360	K22170237	CHIP CAP.	GRM40CH121J50PT	120pF	50V CH
C 6361	K22170237	CHIP CAP.	GRM40CH121J50PT	120pF	50V CH
C 6362	K22170235	CHIP CAP.	GRM40CH101J50PT	100pF	50V CH
C 6363	K22170805	CHIP CAP.	GRM40B102M50PT	0.001uF	50V B
C 6364	K22141808	CHIP CAP.	GRM42-6B473M25PT	0.047uF	25V B
C 6365	K22141809	CHIP CAP.	GRM42-6B104M25PT	0.1uF	25V B
C 6366	K46170030	AL. ELECTRO. CAP.	50V010M4X7TR2	1uF	50V
C 6367	K22141809	CHIP CAP.	GRM42-6B104M25PT	0.1uF	25V B
C 6368	K46170030	AL. ELECTRO. CAP.	50V010M4X7TR2	1uF	50V
C 6369	K46170030	AL. ELECTRO. CAP.	50V010M4X7TR2	1uF	50V
C 6370	K46170030	AL. ELECTRO. CAP.	50V010M4X7TR2	1uF	50V
C 6371	K22170817	CHIP CAP.	GRM40B103M50PT	0.01uF	50V B
C 6372	K22170805	CHIP CAP.	GRM40B102M50PT	0.001uF	50V B
C 6373	K22141809	CHIP CAP.	GRM42-6B104M25PT	0.1uF	25V B
C 6374	K22170821	CHIP CAP.	GRM40B223M50PT	0.022uF	50V B
C 6375	K22170817	CHIP CAP.	GRM40B103M50PT	0.01uF	50V B
C 6376	K22170219	CHIP CAP.	GRM40CH220J50PT	22pF	50V CH
C 6377	K22170219	CHIP CAP.	GRM40CH220J50PT	22pF	50V CH
C 6378	K22170235	CHIP CAP.	GRM40CH101J50PT	100pF	50V CH
C 6379	K22170211	CHIP CAP.	GRM40CH100D50PT	10pF	50V CH
C 6380	K22141809	CHIP CAP.	GRM42-6B104M25PT	0.1uF	25V B
C 6381	K22170817	CHIP CAP.	GRM40B103M50PT	0.01uF	50V B
C 6382	K22170805	CHIP CAP.	GRM40B102M50PT	0.001uF	50V B
C 6383	K22170223	CHIP CAP.	GRM40CH330J50PT	33pF	50V CH
C 6384	K22170223	CHIP CAP.	GRM40CH330J50PT	33pF	50V CH
C 6385	K22170223	CHIP CAP.	GRM40CH330J50PT	33pF	50V CH
C 6386	K22170821	CHIP CAP.	GRM40B223M50PT	0.022uF	50V B
C 6387	K22170805	CHIP CAP.	GRM40B102M50PT	0.001uF	50V B
C 6388	K22170205	CHIP CAP.	GRM40CH040C50PT	4pF	50V CH
C 6389	K22170205	CHIP CAP.	GRM40CH040C50PT	4pF	50V CH
C 6390	K22170230	CHIP CAP.	GRM40CH620J50PT	62p	50V CH
C 6391	K22170230	CHIP CAP.	GRM40CH620J50PT	62p	50V CH
C 6392	K22170230	CHIP CAP.	GRM40CH620J50PT	62p	50V CH
C 6393	K22170230	CHIP CAP.	GRM40CH620J50PT	62p	50V CH
C 6394	K22170821	CHIP CAP.	GRM40B223M50PT	0.022uF	50V B
C 6395	K22170817	CHIP CAP.	GRM40B103M50PT	0.01uF	50V B
C 6396	K22170817	CHIP CAP.	GRM40B103M50PT	0.01uF	50V B
C 6397	K22170817	CHIP CAP.	GRM40B103M50PT	0.01uF	50V B
C 6398	K22170817	CHIP CAP.	GRM40B103M50PT	0.01uF	50V B
C 6399	K22170210	CHIP CAP.	GRM40CH090D50PT	9pF	50V CH
C 6400	K22170235	CHIP CAP.	GRM40CH101J50PT	100pF	50V CH
C 6401	K70127225	TANTALUM CAP.	DN1C2R2M1S	2.2uF	16V
C 6402	K22170815	CHIP CAP.	GRM40B682M50PT	0.0068uF	50V B
C 6403	K22170805	CHIP CAP.	GRM40B102M50PT	0.001uF	50V B
C 6404	K46120004	AL. ELECTRO. CAP.	16V100M4X7TR2	10uF	16V
C 6405	K22171008	CHIP CAP.	GRM40F473Z50PT	0.047uF	50V F
CD6001	H7900180	CERAMIC DISC	CDB455C7		
CF6001	H3900371	CERAMIC FILTER	CFW455HT		
CF6002	H3900386	CERAMIC FILTER	CFJ455K14		
CF6003	H3900387	CERAMIC FILTER	LF-H8S		
D 6002	G2015880	DIODE	1S1588		
D 6003	G2015880	DIODE	1S1588		
D 6004	G2015880	DIODE	1S1588		
D 6005	G2090338	DIODE	1SS81		
D 6006	G2090338	DIODE	1SS81		
D 6007	G2090338	DIODE	1SS81		
D 6008	G2090338	DIODE	1SS81		
D 6009	G2090338	DIODE	1SS81		
D 6010	G2090338	DIODE	1SS81		
D 6013	G2090244	DIODE	1SS106		
D 6014	G2090244	DIODE	1SS106		
D 6015	G2060004	DIODE	1SS270TJ		
D 6016	G2060004	DIODE	1SS270TJ		
D 6017	G2060004	DIODE	1SS270TJ		
D 6018	G2060004	DIODE	1SS270TJ		
D 6019	G2090244	DIODE	1SS106		
D 6020	G2090244	DIODE	1SS106		
D 6021	G2090244	DIODE	1SS106		
D 6022	G2090244	DIODE	1SS106		
D 6023	G2060004	DIODE	1SS270TJ		
D 6024	G2060004	DIODE	1SS270TJ		
D 6025	G2060004	DIODE	1SS270TJ		
D 6026	G2060004	DIODE	1SS270TJ		

For Service Manuals Contact
MAURITRON TECHNICAL SERVICES
 8 Cherry Tree Rd. Chinnor
 Oxon OX9 4QY
 Tel: 01844-351694 Fax: 01844-352554
 Email: enquiries@mauritron.co.uk

RX-2 Unit Parts List

ADD	CODE NO	DESCRIPTION	DEVICE	TYP VAL
D 6027	G2060004	DIODE	1SS270TJ	
D 6028	G2060004	DIODE	1SS270TJ	
D 6029	G2060004	DIODE	1SS270TJ	
D 6030	G2060004	DIODE	1SS270TJ	
D 6031	G2060004	DIODE	1SS270TJ	
D 6032	G2060004	DIODE	1SS270TJ	
D 6033	G2060004	DIODE	1SS270TJ	
D 6034	G2070074	DIODE	1SV200-TR	
D 6035	G2090165	DIODE	FC-52M-5	
D 6036	G2090023	DIODE	1SV50	
D 6037	G2090023	DIODE	1SV50	
D 6038	G2090165	DIODE	FC-52M-5	
D 6039	G2090165	DIODE	FC-52M-5	
D 6040	G2060002	DIODE	1SS53T1	
D 6041	G2090165	DIODE	FC-52M-5	
D 6042	G2060002	DIODE	1SS53T1	
D 6043	G2090165	DIODE	FC-52M-5	
D 6044	G2060002	DIODE	1SS53T1	
D 6045	G2090165	DIODE	FC-52M-5	
D 6046	G2060002	DIODE	1SS53T1	
D 6047	G2060004	DIODE	1SS270TJ	
D 6048	G2060004	DIODE	1SS270TJ	
D 6049	G2060004	DIODE	1SS270TJ	
D 6050	G2060004	DIODE	1SS270TJ	
D 6051	G2060004	DIODE	1SS270TJ	
D 6052	G2060004	DIODE	1SS270TJ	
D 6053	G2060004	DIODE	1SS270TJ	
D 6054	G2060004	DIODE	1SS270TJ	
D 6055	G2060004	DIODE	1SS270TJ	
D 6056	G2060004	DIODE	1SS270TJ	
D 6057	G2060004	DIODE	1SS270TJ	
D 6058	G2060004	DIODE	1SS270TJ	
D 6059	G2060004	DIODE	1SS270TJ	
D 6060	G2060004	DIODE	1SS270TJ	
D 6061	G2060004	DIODE	1SS270TJ	
D 6062	G2090405	DIODE	HZ7C1	
D 6063	G2060004	DIODE	1SS270TJ	
D 6064	G2060004	DIODE	1SS270TJ	
D 6066	G2060004	DIODE	1SS270TJ	
D 6067	G2060004	DIODE	1SS270TJ	
D 6068	G2060004	DIODE	1SS270TJ	
D 6069	G2060004	DIODE	1SS270TJ	
D 6070	G2070009	DIODE	1SS184 TE85R	
D 6071	G2060004	DIODE	1SS270TJ	
D 6072	G2060004	DIODE	1SS270TJ	
D 6073	G2060004	DIODE	1SS270TJ	
D 6074	G2090225	DIODE	HZ6C2L	
D 6075	G2060004	DIODE	1SS270TJ	
D 6076	G2060004	DIODE	1SS270TJ	
D 6077	G2060004	DIODE	1SS270TJ	
J 6001	P1090255	CONNECTOR	TMP-JA	
J 6002	P0090623	CONNECTOR	SC25-04WS	
J 6003	P0090623	CONNECTOR	SC25-04WS	
J 6004	P0090621	CONNECTOR	SC25-02WS	
J 6005	P0090621	CONNECTOR	SC25-02WS	
J 6006	P0090621	CONNECTOR	SC25-02WS	
J 6007	P0090626	CONNECTOR	SC25-07WS	
J 6008	P0090625	CONNECTOR	SC25-06WS	
J 6009	P0090621	CONNECTOR	SC25-02WS	
J 6010	P0090624	CONNECTOR	SC25-05WS	
L 6001	L0021934	COIL	1U T25-6	
L 6002	L0021935	COIL	1.37U T25-6	
L 6003	L0021935	COIL	1.37U T25-6	
L 6004	L1790164	M.RFC	LAL03VB102K	1mH
L 6005	L1790164	M.RFC	LAL03VB102K	1mH
L 6006	L1790164	M.RFC	LAL03VB102K	1mH
L 6007	L1790164	M.RFC	LAL03VB102K	1mH
L 6008	L1790164	M.RFC	LAL03VB102K	1mH
L 6009	L1790164	M.RFC	LAL03VB102K	1mH
L 6010	L1790060	M.RFC	LAP02TA150K	15uH
L 6011	L1790072	M.RFC	LAP02TA151K	150uH
L 6012	L1790045	M.RFC	LAP02TAR82K	0.82uH
L 6013	L1790045	M.RFC	LAP02TAR82K	0.82uH
L 6014	L1790045	M.RFC	LAP02TAR82K	0.82uH
L 6015	L1790045	M.RFC	LAP02TAR82K	0.82uH
L 6016	L1790070	M.RFC	LAP02TA101K	100uH
L 6017	L1790061	M.RFC	LAP02TA180K	18uH
L 6018	L1790061	M.RFC	LAP02TA180K	18uH
L 6019	L0021267	COIL	1.00U R12-1377X	
L 6020	L1790046	M.RFC	LAP02TA180K	1uH
L 6021	L1790070	M.RFC	LAP02TA101K	100uH
L 6022	L1790070	M.RFC	LAP02TA101K	100uH
L 6023	L1790062	M.RFC	LAP02TA220K	22uH

For Service Manuals Contact
MAURITRON TECHNICAL SERVICES
 8 Cherry Tree Rd, Chinnor
 Oxon OX9 4QY
 Tel: 01844-351694 Fax: 01844-352554
 Email: enquiries@mauritron.co.uk

RX-2 Unit Parts List

ADD	CODE NO	DESCRIPTION	DEVICE	TYP VAL
L 6024	L1790062	M.RFC	LAP02TA220K	22uH
L 6025	L1790051	M.RFC	LAP02TA2R7K	2.7u
L 6028	L0190025	COIL	S18	
L 6030	L1790052	M.RFC	LAP02TA3R3K	3.3uH
L 6031	L1790064	M.RFC	LAP02TA330K	33uH
L 6032	L1790067	M.RFC	LAP02TA560K	56uH
L 6033	L1790054	M.RFC	LAP02TA4R7K	4.7uH
L 6034	L0190161	COIL	S18 M85T	
L 6035	L1790055	M.RFC	LAP02TA5R6K	5.6uH
L 6036	L1790054	M.RFC	LAP02TA4R7K	4.7uH
L 6037	L0190162	COIL	S18 M75T	
L 6038	L1790054	M.RFC	LAP02TA4R7K	4.7uH
L 6039	L1790054	M.RFC	LAP02TA4R7K	4.7uH
L 6040	L0190163	COIL	S18 M65T	
L 6041	L1790053	M.RFC	LAP02TA3R9K	3.9uH
L 6042	L1790054	M.RFC	LAP02TA4R7K	4.7uH
L 6043	L0190164	COIL	S18 M55T	
L 6044	L1790052	M.RFC	LAP02TA3R3K	3.3uH
L 6045	L1790070	M.RFC	LAP02TA101K	100uH
L 6046	L1790045	M.RFC	LAP02TAR82K	0.82uH
L 6047	L0021553	COIL		
L 6048	L0021554	COIL	0.82U	
L 6049	L0021554	COIL	0.82U	
L 6050	L0021553	COIL		
L 6051	L0021555	COIL	1.20U	
L 6052	L1790058	M.RFC	LAP02TA100K	10uH
L 6054	L0020951	COIL	6.5T3.0D0.4UEW R	
L 6055	L0020340	COIL	5.5T3.0D0.5UEW R	
L 6056	L0021085	COIL	0.260U T25-10	
L 6057	L0020824	COIL	0.170U T25-10	
L 6058	L1790070	M.RFC	LAP02TA101K	100uH
L 6059	L1790041	M.RFC	LAP02TAR39K	0.39uH
L 6060	L1790051	M.RFC	LAP02TA2R7K	2.7u
L 6061	L1790038	M.RFC	LAP02TAR22K	0.22uH
L 6062	L1790042	M.RFC	LAP02TAR47K	0.47uH
L 6063	L1790042	M.RFC	LAP02TAR47K	0.47uH
Q 6001	G3801250	FET	2SK125	
Q 6002	G3801250	FET	2SK125	
Q 6003	G4800740L	FET	3SK74L	
Q 6004	G3805070F	FET	2SK507F	
Q 6005	G3805070F	FET	2SK507F	
Q 6006	G3805070F	FET	2SK507F	
Q 6007	G3805070F	FET	2SK507F	
Q 6008	G4800740L	FET	3SK74L	
Q 6009	G4800740L	FET	3SK74L	
Q 6010	G3326207B	TRANSISTOR	2SC2620QBTR	
Q 6011	G3327127G	TRANSISTOR	2SC2712GR TE85R	
Q 6012	G3327127G	TRANSISTOR	2SC2712GR TE85R	
Q 6013	G1090772	IC	LC4066BM	
Q 6014	G3327127G	TRANSISTOR	2SC2712GR TE85R	
Q 6015	G1090101	IC	UPC1037H	
Q 6016	G1090589	IC	NJM2904M	
Q 6017	G3327127G	TRANSISTOR	2SC2712GR TE85R	
Q 6018	G4800740L	FET	3SK74L	
Q 6019	G4800740L	FET	3SK74L	
Q 6020	G3326197B	TRANSISTOR	2SC2619FBTR	
Q 6021	G3327127G	TRANSISTOR	2SC2712GR TE85R	
Q 6022	G3327127G	TRANSISTOR	2SC2712GR TE85R	
Q 6023	G3111627G	TRANSISTOR	2SA1162GR TE85R	
Q 6024	G3327127G	TRANSISTOR	2SC2712GR TE85R	
Q 6025	G3111627G	TRANSISTOR	2SA1162GR TE85R	
Q 6028	G3327127G	TRANSISTOR	2SC2712GR TE85R	
Q 6029	G1090908	IC	NJM2902M	
Q 6030	G3327127G	TRANSISTOR	2SC2712GR TE85R	
Q 6031	G3326207B	TRANSISTOR	2SC2620QBTR	
Q 6032	G3326197B	TRANSISTOR	2SC2619FBTR	
Q 6033	G3326197B	TRANSISTOR	2SC2619FBTR	
Q 6034	G1090101	IC	UPC1037H	
Q 6035	G3327127G	TRANSISTOR	2SC2712GR TE85R	
Q 6036	G3327127G	TRANSISTOR	2SC2712GR TE85R	
Q 6037	G3327127G	TRANSISTOR	2SC2712GR TE85R	
Q 6038	G1090739	IC	MC145163SL	
Q 6039	G3326207B	TRANSISTOR	2SC2620QBTR	
Q 6040	G3326197B	TRANSISTOR	2SC2619FBTR	
Q 6041	G3326197B	TRANSISTOR	2SC2619FBTR	
Q 6042	G3326197B	TRANSISTOR	2SC2619FBTR	
Q 6043	G3326197B	TRANSISTOR	2SC2619FBTR	
Q 6044	G3326207B	TRANSISTOR	2SC2620QBTR	
Q 6045	G3326197B	TRANSISTOR	2SC2619FBTR	
Q 6046	G3326197B	TRANSISTOR	2SC2619FBTR	
Q 6047	G1090470	IC	UPB555C	
Q 6048	G3327127G	TRANSISTOR	2SC2712GR TE85R	
Q 6049	G1090739	IC	MC145163SL	

RX-2 Unit Parts List

ADD	CODE NO	DESCRIPTION	DEVICE	TYP	VAL
Q	6050	G3326197B	TRANSISTOR	2SC2619FBTR	
Q	6051	G3327127G	TRANSISTOR	2SC2712GR TE85R	
Q	6052	G1090974	IC	TC4S584F TE85R	
Q	6053	G1090067	IC	MC14013BCP	
Q	6054	G1090473	IC	TC5081AP	
Q	6055	G3801921B	FET	2SK192A-BL	
Q	6056	G3803027Y	FET	2SK302Y TE85R	
Q	6057	G3326207B	TRANSISTOR	2SC2620QBTR	
Q	6058	G3326207B	TRANSISTOR	2SC2620QBTR	
Q	6059	G1090101	IC	UPC1037H	
Q	6060	G3327127G	TRANSISTOR	2SC2712GR TE85R	
Q	6061	G1090974	IC	TC4S584F TE85R	
Q	6062	G3327127G	TRANSISTOR	2SC2712GR TE85R	
Q	6063	G3326197B	TRANSISTOR	2SC2619FBTR	
Q	6064	G3326197B	TRANSISTOR	2SC2619FBTR	
Q	6065	G3801921B	FET	2SK192A-BL	
Q	6066	G3801921B	FET	2SK192A-BL	
Q	6067	G3801921B	FET	2SK192A-BL	
Q	6068	G3801921B	FET	2SK192A-BL	
Q	6069	G3803027G	FET	2SK302GR TE85R	
Q	6070	G3803027Y	FET	2SK302Y TE85R	
Q	6071	G1090101	IC	UPC1037H	
Q	6072	G3326207B	TRANSISTOR	2SC2620QBTR	
Q	6073	G1090834	IC	CX-7925B	
Q	6074	G3802087Y	FET	2SK208Y TE85R	
Q	6075	G3327127G	TRANSISTOR	2SC2712GR TE85R	
Q	6076	G3327127G	TRANSISTOR	2SC2712GR TE85R	
Q	6077	G3327147Y	TRANSISTOR	2SC2714YTE85R	
Q	6078	G3327147Y	TRANSISTOR	2SC2714YTE85R	
Q	6079	G3333550	TRANSISTOR	2SC3355	
Q	6080	G3070001	TRANSISTOR	FA1A4M-T2B	
Q	6081	G3070001	TRANSISTOR	FA1A4M-T2B	
Q	6082	G3070001	TRANSISTOR	FA1A4M-T2B	
Q	6083	G3070001	TRANSISTOR	FA1A4M-T2B	
Q	6084	G3070001	TRANSISTOR	FA1A4M-T2B	
Q	6087	G1090084	IC	UPC78L05	
Q	6088	G3070001	TRANSISTOR	FA1A4M-T2B	
Q	6089	G3070010	TRANSISTOR	DTA143EK T96	
Q	6091	G3070001	TRANSISTOR	FA1A4M-T2B	
Q	6092	G3070005	TRANSISTOR	FN1A4M-T2B	
Q	6093	G3070005	TRANSISTOR	FN1A4M-T2B	
Q	6094	G3070005	TRANSISTOR	FN1A4M-T2B	
Q	6095	G3070001	TRANSISTOR	FA1A4M-T2B	
Q	6096	G3070001	TRANSISTOR	FA1A4M-T2B	
Q	6097	G3070001	TRANSISTOR	FA1A4M-T2B	
Q	6098	G3070001	TRANSISTOR	FA1A4M-T2B	
Q	6099	G3070001	TRANSISTOR	FA1A4M-T2B	
Q	6100	G3070001	TRANSISTOR	FA1A4M-T2B	
Q	6101	G3326197B	TRANSISTOR	2SC2619FBTR	
Q	6102	G1090957	IC	TK10487MT1	
Q	6103	G1090589	IC	NJM2904M	
Q	6105	G3070001	TRANSISTOR	FA1A4M-T2B	
Q	6106	G3070046	TRANSISTOR	FMC3 T99	
Q	6107	G3070001	TRANSISTOR	FA1A4M-T2B	
Q	6108	G1090895	IC	TC4S81F TE85R	
Q	6109	G3070001	TRANSISTOR	FA1A4M-T2B	
Q	6110	G3070001	TRANSISTOR	FA1A4M-T2B	
R	6001	J24205471	CHIP RES.	RMC1/10T 471J	470 1/10W
R	6002	J24205471	CHIP RES.	RMC1/10T 471J	470 1/10W
R	6003	J24205100	CHIP RES.	RMC1/10T 100J	10 1/10W
R	6004	J24205100	CHIP RES.	RMC1/10T 100J	10 1/10W
R	6005	J24205104	CHIP RES.	RMC1/10T 104J	100K 1/10W
R	6006	J24205183	CHIP RES.	RMC1/10T 183J	18K 1/10W
R	6007	J24205474	CHIP RES.	RMC1/10T 474J	470K 1/10W
R	6009	J24205221	CHIP RES.	RMC1/10T 221J	220 1/10W
R	6010	J24205101	CHIP RES.	RMC1/10T 101J	100 1/10W
R	6011	J24205000	CHIP RES.	RMC1/10T 000J	0 1/10W
R	6012	J24205103	CHIP RES.	RMC1/10T 103J	10K 1/10W
R	6013	J24205471	CHIP RES.	RMC1/10T 471J	470 1/10W
R	6014	J24205471	CHIP RES.	RMC1/10T 471J	470 1/10W
R	6015	J24205470	CHIP RES.	RMC1/10T 470J	47 1/10W
R	6016	J24205472	CHIP RES.	RMC1/10T 472J	4.7K 1/10W
R	6017	J24205682	CHIP RES.	RMC1/10T 682J	6.8K 1/10W
R	6018	J24205332	CHIP RES.	RMC1/10T 332J	3.3K 1/10W
R	6019	J24205472	CHIP RES.	RMC1/10T 472J	4.7K 1/10W
R	6020	J24205471	CHIP RES.	RMC1/10T 471J	470 1/10W
R	6021	J24205471	CHIP RES.	RMC1/10T 471J	470 1/10W
R	6022	J24205680	CHIP RES.	RMC1/10T 680J	68 1/10W
R	6023	J24205222	CHIP RES.	RMC1/10T 222J	2.2K 1/10W
R	6024	J24205333	CHIP RES.	RMC1/10T 333J	33K 1/10W
R	6025	J24205102	CHIP RES.	RMC1/10T 102J	1K 1/10W
R	6026	J24205102	CHIP RES.	RMC1/10T 102J	1K 1/10W
R	6027	J24205102	CHIP RES.	RMC1/10T 102J	1K 1/10W

For Service Manuals Contact
MAURITRON TECHNICAL SERVICES
 8 Cherry Tree Rd, Chinnor
 Oxon OX9 4QY
 Tel: 01844-351694 Fax: 01844-352554
 Email: enquiries@mauritron.co.uk

RX-2 Unit Parts List

ADD	CODE NO	DESCRIPTION	DEVICE	TYP	VAL
R 6028	J24205152	CHIP RES.	RMC1/10T 152J	1.5K	1/10W
R 6029	J24205823	CHIP RES.	RMC1/10T 823J	82K	1/10W
R 6030	J24205123	CHIP RES.	RMC1/10T 123J	12K	1/10W
R 6031	J24205101	CHIP RES.	RMC1/10T 101J	100	1/10W
R 6033	J24205101	CHIP RES.	RMC1/10T 101J	100	1/10W
R 6034	J24205101	CHIP RES.	RMC1/10T 101J	100	1/10W
R 6035	J24205104	CHIP RES.	RMC1/10T 104J	100K	1/10W
R 6036	J24205153	CHIP RES.	RMC1/10T 153J	15K	1/10W
R 6037	J24205101	CHIP RES.	RMC1/10T 101J	100	1/10W
R 6038	J24205101	CHIP RES.	RMC1/10T 101J	100	1/10W
R 6039	J24205151	CHIP RES.	RMC1/10T 151J	150	1/10W
R 6040	J24205101	CHIP RES.	RMC1/10T 101J	100	1/10W
R 6041	J24205223	CHIP RES.	RMC1/10T 223J	22K	1/10W
R 6042	J24205682	CHIP RES.	RMC1/10T 682J	6.8K	1/10W
R 6043	J24205222	CHIP RES.	RMC1/10T 222J	2.2K	1/10W
R 6044	J24205221	CHIP RES.	RMC1/10T 221J	220	1/10W
R 6045	J24205103	CHIP RES.	RMC1/10T 103J	10K	1/10W
R 6046	J24205154	CHIP RES.	RMC1/10T 154J	150K	1/10W
R 6047	J24205102	CHIP RES.	RMC1/10T 102J	1K	1/10W
R 6048	J24205101	CHIP RES.	RMC1/10T 101J	100	1/10W
R 6049	J24205473	CHIP RES.	RMC1/10T 473J	47K	1/10W
R 6050	J24205101	CHIP RES.	RMC1/10T 101J	100	1/10W
R 6051	J24205225	CHIP RES.	RMC1/10T 225J	2.2M	1/10W
R 6052	J24205103	CHIP RES.	RMC1/10T 103J	10K	1/10W
R 6053	J24205103	CHIP RES.	RMC1/10T 103J	10K	1/10W
R 6054	J24205103	CHIP RES.	RMC1/10T 103J	10K	1/10W
R 6055	J24205104	CHIP RES.	RMC1/10T 104J	100K	1/10W
R 6056	J24205334	CHIP RES.	RMC1/10T 334J	330K	1/10W
R 6057	J24205221	CHIP RES.	RMC1/10T 221J	220	1/10W
R 6058	J24205101	CHIP RES.	RMC1/10T 101J	100	1/10W
R 6059	J24205332	CHIP RES.	RMC1/10T 332J	3.3K	1/10W
R 6060	J24205151	CHIP RES.	RMC1/10T 151J	150	1/10W
R 6061	J24205472	CHIP RES.	RMC1/10T 472J	4.7K	1/10W
R 6062	J24205104	CHIP RES.	RMC1/10T 104J	100K	1/10W
R 6063	J24205223	CHIP RES.	RMC1/10T 223J	22K	1/10W
R 6064	J24205103	CHIP RES.	RMC1/10T 103J	10K	1/10W
R 6065	J24205103	CHIP RES.	RMC1/10T 103J	10K	1/10W
R 6066	J24205472	CHIP RES.	RMC1/10T 472J	4.7K	1/10W
R 6067	J24205153	CHIP RES.	RMC1/10T 153J	15K	1/10W
R 6068	J24205333	CHIP RES.	RMC1/10T 333J	33K	1/10W
R 6069	J24205104	CHIP RES.	RMC1/10T 104J	100K	1/10W
R 6070	J24205392	CHIP RES.	RMC1/10T 392J	3.9K	1/10W
R 6071	J24205123	CHIP RES.	RMC1/10T 123J	12K	1/10W
R 6072	J24205472	CHIP RES.	RMC1/10T 472J	4.7K	1/10W
R 6073	J24205472	CHIP RES.	RMC1/10T 472J	4.7K	1/10W
R 6074	J24205104	CHIP RES.	RMC1/10T 104J	100K	1/10W
R 6075	J24205104	CHIP RES.	RMC1/10T 104J	100K	1/10W
R 6076	J24205223	CHIP RES.	RMC1/10T 223J	22K	1/10W
R 6077	J24205223	CHIP RES.	RMC1/10T 223J	22K	1/10W
R 6078	J24205104	CHIP RES.	RMC1/10T 104J	100K	1/10W
R 6079	J24205472	CHIP RES.	RMC1/10T 472J	4.7K	1/10W
R 6080	J24205104	CHIP RES.	RMC1/10T 104J	100K	1/10W
R 6081	J24205104	CHIP RES.	RMC1/10T 104J	100K	1/10W
R 6082	J24205222	CHIP RES.	RMC1/10T 222J	2.2K	1/10W
R 6083	J24205473	CHIP RES.	RMC1/10T 473J	47K	1/10W
R 6084	J24205101	CHIP RES.	RMC1/10T 101J	100	1/10W
R 6085	J24205104	CHIP RES.	RMC1/10T 104J	100K	1/10W
R 6086	J24205183	CHIP RES.	RMC1/10T 183J	18K	1/10W
R 6087	J24205101	CHIP RES.	RMC1/10T 101J	100	1/10W
R 6088	J24205102	CHIP RES.	RMC1/10T 102J	1K	1/10W
R 6089	J24205680	CHIP RES.	RMC1/10T 680J	68	1/10W
R 6090	J24205101	CHIP RES.	RMC1/10T 101J	100	1/10W
R 6091	J24205333	CHIP RES.	RMC1/10T 333J	33K	1/10W
R 6092	J24205104	CHIP RES.	RMC1/10T 104J	100K	1/10W
R 6093	J24205183	CHIP RES.	RMC1/10T 183J	18K	1/10W
R 6094	J24205101	CHIP RES.	RMC1/10T 101J	100	1/10W
R 6095	J24205102	CHIP RES.	RMC1/10T 102J	1K	1/10W
R 6096	J24205680	CHIP RES.	RMC1/10T 680J	68	1/10W
R 6097	J24205101	CHIP RES.	RMC1/10T 101J	100	1/10W
R 6098	J24205223	CHIP RES.	RMC1/10T 223J	22K	1/10W
R 6099	J24205682	CHIP RES.	RMC1/10T 682J	6.8K	1/10W
R 6100	J24205151	CHIP RES.	RMC1/10T 151J	150	1/10W
R 6101	J24205101	CHIP RES.	RMC1/10T 101J	100	1/10W
R 6102	J24205104	CHIP RES.	RMC1/10T 104J	100K	1/10W
R 6103	J24205103	CHIP RES.	RMC1/10T 103J	10K	1/10W
R 6104	J24205334	CHIP RES.	RMC1/10T 334J	330K	1/10W
R 6105	J24205101	CHIP RES.	RMC1/10T 101J	100	1/10W
R 6106	J24205103	CHIP RES.	RMC1/10T 103J	10K	1/10W
R 6107	J24205103	CHIP RES.	RMC1/10T 103J	10K	1/10W
R 6108	J24205102	CHIP RES.	RMC1/10T 102J	1K	1/10W
R 6109	J24205473	CHIP RES.	RMC1/10T 473J	47K	1/10W
R 6110	J24205473	CHIP RES.	RMC1/10T 473J	47K	1/10W
R 6111	J24205473	CHIP RES.	RMC1/10T 473J	47K	1/10W

RX-2 Unit Parts List

ADD	CODE NO	DESCRIPTION	DEVICE	TYP	VAL
R 6112	J24205470	CHIP RES.	RMC1/10T 470J	47	1/10W
R 6113	J24205223	CHIP RES.	RMC1/10T 223J	22K	1/10W
R 6116	J24205102	CHIP RES.	RMC1/10T 102J	1K	1/10W
R 6118	J24205470	CHIP RES.	RMC1/10T 470J	47	1/10W
R 6119	J24205153	CHIP RES.	RMC1/10T 153J	15K	1/10W
R 6120	J24205473	CHIP RES.	RMC1/10T 473J	47K	1/10W
R 6121	J24205222	CHIP RES.	RMC1/10T 222J	2.2K	1/10W
R 6122	J24205224	CHIP RES.	RMC1/10T 224J	220K	1/10W
R 6123	J24205473	CHIP RES.	RMC1/10T 473J	47K	1/10W
R 6124	J24205333	CHIP RES.	RMC1/10T 333J	33K	1/10W
R 6125	J24205333	CHIP RES.	RMC1/10T 333J	33K	1/10W
R 6126	J24205223	CHIP RES.	RMC1/10T 223J	22K	1/10W
R 6127	J24205474	CHIP RES.	RMC1/10T 474J	470K	1/10W
R 6128	J24205103	CHIP RES.	RMC1/10T 103J	10K	1/10W
R 6129	J24205472	CHIP RES.	RMC1/10T 472J	4.7K	1/10W
R 6130	J24205472	CHIP RES.	RMC1/10T 472J	4.7K	1/10W
R 6131	J24205472	CHIP RES.	RMC1/10T 472J	4.7K	1/10W
R 6132	J24205332	CHIP RES.	RMC1/10T 332J	3.3K	1/10W
R 6133	J24205103	CHIP RES.	RMC1/10T 103J	10K	1/10W
R 6134	J24205472	CHIP RES.	RMC1/10T 472J	4.7K	1/10W
R 6135	J24205472	CHIP RES.	RMC1/10T 472J	4.7K	1/10W
R 6136	J24205472	CHIP RES.	RMC1/10T 472J	4.7K	1/10W
R 6137	J24205332	CHIP RES.	RMC1/10T 332J	3.3K	1/10W
R 6138	J24205223	CHIP RES.	RMC1/10T 223J	22K	1/10W
R 6139	J07225332	CARBON FILM RES.	RD16TPJ332 3.3K	3.3K	1/6W
R 6140	J24205682	CHIP RES.	RMC1/10T 682J	6.8K	1/10W
R 6141	J24205101	CHIP RES.	RMC1/10T 101J	100	1/10W
R 6142	J24205102	CHIP RES.	RMC1/10T 102J	1K	1/10W
R 6143	J24205223	CHIP RES.	RMC1/10T 223J	22K	1/10W
R 6144	J24205682	CHIP RES.	RMC1/10T 682J	6.8K	1/10W
R 6145	J24205331	CHIP RES.	RMC1/10T 331J	330	1/10W
R 6146	J24205680	CHIP RES.	RMC1/10T 680J	68	1/10W
R 6147	J24205221	CHIP RES.	RMC1/10T 221J	220	1/10W
R 6148	J24205101	CHIP RES.	RMC1/10T 101J	100	1/10W
R 6149	J24205104	CHIP RES.	RMC1/10T 104J	100K	1/10W
R 6150	J24205681	CHIP RES.	RMC1/10T 681J	680	1/10W
R 6151	J24205151	CHIP RES.	RMC1/10T 151J	150	1/10W
R 6152	J24205102	CHIP RES.	RMC1/10T 102J	1K	1/10W
R 6153	J24205104	CHIP RES.	RMC1/10T 104J	100K	1/10W
R 6154	J24205151	CHIP RES.	RMC1/10T 151J	150	1/10W
R 6155	J24205101	CHIP RES.	RMC1/10T 101J	100	1/10W
R 6156	J24205101	CHIP RES.	RMC1/10T 101J	100	1/10W
R 6157	J24205680	CHIP RES.	RMC1/10T 680J	68	1/10W
R 6158	J24205101	CHIP RES.	RMC1/10T 101J	100	1/10W
R 6159	J24205680	CHIP RES.	RMC1/10T 680J	68	1/10W
R 6160	J24205680	CHIP RES.	RMC1/10T 680J	68	1/10W
R 6161	J24205224	CHIP RES.	RMC1/10T 224J	220K	1/10W
R 6162	J24205221	CHIP RES.	RMC1/10T 221J	220	1/10W
R 6163	J24205102	CHIP RES.	RMC1/10T 102J	1K	1/10W
R 6164	J24205101	CHIP RES.	RMC1/10T 101J	100	1/10W
R 6165	J24205104	CHIP RES.	RMC1/10T 104J	100K	1/10W
R 6166	J24205102	CHIP RES.	RMC1/10T 102J	1K	1/10W
R 6167	J24205680	CHIP RES.	RMC1/10T 680J	68	1/10W
R 6168	J24205223	CHIP RES.	RMC1/10T 223J	22K	1/10W
R 6169	J24205101	CHIP RES.	RMC1/10T 101J	100	1/10W
R 6170	J24205104	CHIP RES.	RMC1/10T 104J	100K	1/10W
R 6171	J24205104	CHIP RES.	RMC1/10T 104J	100K	1/10W
R 6172	J24205101	CHIP RES.	RMC1/10T 101J	100	1/10W
R 6173	J24205102	CHIP RES.	RMC1/10T 102J	1K	1/10W
R 6174	J24205104	CHIP RES.	RMC1/10T 104J	100K	1/10W
R 6175	J24205101	CHIP RES.	RMC1/10T 101J	100	1/10W
R 6176	J24205471	CHIP RES.	RMC1/10T 471J	470	1/10W
R 6177	J24205224	CHIP RES.	RMC1/10T 224J	220K	1/10W
R 6178	J24205101	CHIP RES.	RMC1/10T 101J	100	1/10W
R 6179	J24205221	CHIP RES.	RMC1/10T 221J	220	1/10W
R 6180	J24205223	CHIP RES.	RMC1/10T 223J	22K	1/10W
R 6181	J24205472	CHIP RES.	RMC1/10T 472J	4.7K	1/10W
R 6182	J24205101	CHIP RES.	RMC1/10T 101J	100	1/10W
R 6183	J24205221	CHIP RES.	RMC1/10T 221J	220	1/10W
R 6184	J24205223	CHIP RES.	RMC1/10T 223J	22K	1/10W
R 6185	J24205472	CHIP RES.	RMC1/10T 472J	4.7K	1/10W
R 6186	J24205101	CHIP RES.	RMC1/10T 101J	100	1/10W
R 6187	J24205101	CHIP RES.	RMC1/10T 101J	100	1/10W
R 6188	J24205681	CHIP RES.	RMC1/10T 681J	680	1/10W
R 6189	J24205222	CHIP RES.	RMC1/10T 222J	2.2K	1/10W
R 6190	J24205221	CHIP RES.	RMC1/10T 221J	220	1/10W
R 6191	J24205104	CHIP RES.	RMC1/10T 104J	100K	1/10W
R 6192	J24205332	CHIP RES.	RMC1/10T 332J	3.3K	1/10W
R 6193	J24205104	CHIP RES.	RMC1/10T 104J	100K	1/10W
R 6194	J24205101	CHIP RES.	RMC1/10T 101J	100	1/10W
R 6195	J24205681	CHIP RES.	RMC1/10T 681J	680	1/10W
R 6196	J24205221	CHIP RES.	RMC1/10T 221J	220	1/10W
R 6197	J24205101	CHIP RES.	RMC1/10T 101J	100	1/10W

For Service Manuals Contact
MAURITZ TECHNICAL SERVICES
 8 Cherry Tree Rd, Chinnor
 Oxon OX9 4QY
 Tel: 01844-351694 Fax: 01844-352554
 Email: enquiries@mauritz.co.uk

RX-2 Unit Parts List

ADD	CODE NO	DESCRIPTION	DEVICE	TYP	VAL
R 6198	J24205104	CHIP RES.	RMC1/10T 104J	100K	1/10W
R 6199	J24205681	CHIP RES.	RMC1/10T 681J	680	1/10W
R 6200	J24205221	CHIP RES.	RMC1/10T 221J	220	1/10W
R 6201	J24205101	CHIP RES.	RMC1/10T 101J	100	1/10W
R 6202	J24205104	CHIP RES.	RMC1/10T 104J	100K	1/10W
R 6203	J24205681	CHIP RES.	RMC1/10T 681J	680	1/10W
R 6204	J24205104	CHIP RES.	RMC1/10T 104J	100K	1/10W
R 6205	J24205101	CHIP RES.	RMC1/10T 101J	100	1/10W
R 6206	J24205102	CHIP RES.	RMC1/10T 102J	1K	1/10W
R 6207	J24205681	CHIP RES.	RMC1/10T 681J	680	1/10W
R 6208	J24205223	CHIP RES.	RMC1/10T 223J	22K	1/10W
R 6209	J24205682	CHIP RES.	RMC1/10T 682J	6.8K	1/10W
R 6210	J24205101	CHIP RES.	RMC1/10T 101J	100	1/10W
R 6211	J24205102	CHIP RES.	RMC1/10T 102J	1K	1/10W
R 6212	J24205680	CHIP RES.	RMC1/10T 680J	68	1/10W
R 6214	J24205104	CHIP RES.	RMC1/10T 104J	100K	1/10W
R 6215	J24205221	CHIP RES.	RMC1/10T 221J	220	1/10W
R 6216	J24205101	CHIP RES.	RMC1/10T 101J	100	1/10W
R 6217	J24205102	CHIP RES.	RMC1/10T 102J	1K	1/10W
R 6218	J24205101	CHIP RES.	RMC1/10T 101J	100	1/10W
R 6219	J24205472	CHIP RES.	RMC1/10T 472J	4.7K	1/10W
R 6220	J24205221	CHIP RES.	RMC1/10T 221J	220	1/10W
R 6221	J24205470	CHIP RES.	RMC1/10T 470J	47	1/10W
R 6222	J24205104	CHIP RES.	RMC1/10T 104J	100K	1/10W
R 6223	J24205154	CHIP RES.	RMC1/10T 154J	150K	1/10W
R 6224	J24205331	CHIP RES.	RMC1/10T 331J	330	1/10W
R 6225	J24205680	CHIP RES.	RMC1/10T 680J	68	1/10W
R 6226	J24205473	CHIP RES.	RMC1/10T 473J	47K	1/10W
R 6227	J24205680	CHIP RES.	RMC1/10T 680J	68	1/10W
R 6228	J24205471	CHIP RES.	RMC1/10T 471J	470	1/10W
R 6229	J24205221	CHIP RES.	RMC1/10T 221J	220	1/10W
R 6230	J24205101	CHIP RES.	RMC1/10T 101J	100	1/10W
R 6231	J24205104	CHIP RES.	RMC1/10T 104J	100K	1/10W
R 6232	J24205681	CHIP RES.	RMC1/10T 681J	680	1/10W
R 6233	J24205221	CHIP RES.	RMC1/10T 221J	220	1/10W
R 6234	J24205101	CHIP RES.	RMC1/10T 101J	100	1/10W
R 6235	J24205104	CHIP RES.	RMC1/10T 104J	100K	1/10W
R 6236	J24205681	CHIP RES.	RMC1/10T 681J	680	1/10W
R 6237	J24205151	CHIP RES.	RMC1/10T 151J	150	1/10W
R 6238	J24205104	CHIP RES.	RMC1/10T 104J	100K	1/10W
R 6239	J24205470	CHIP RES.	RMC1/10T 470J	47	1/10W
R 6240	J24205101	CHIP RES.	RMC1/10T 101J	100	1/10W
R 6241	J24205102	CHIP RES.	RMC1/10T 102J	1K	1/10W
R 6242	J24205223	CHIP RES.	RMC1/10T 223J	22K	1/10W
R 6243	J24205682	CHIP RES.	RMC1/10T 682J	6.8K	1/10W
R 6244	J24205471	CHIP RES.	RMC1/10T 471J	470	1/10W
R 6245	J24205102	CHIP RES.	RMC1/10T 102J	1K	1/10W
R 6246	J24205101	CHIP RES.	RMC1/10T 101J	100	1/10W
R 6247	J24205682	CHIP RES.	RMC1/10T 682J	6.8K	1/10W
R 6248	J24205223	CHIP RES.	RMC1/10T 223J	22K	1/10W
R 6249	J24205472	CHIP RES.	RMC1/10T 472J	4.7K	1/10W
R 6250	J24205331	CHIP RES.	RMC1/10T 331J	330	1/10W
R 6251	J24205101	CHIP RES.	RMC1/10T 101J	100	1/10W
R 6252	J24205223	CHIP RES.	RMC1/10T 223J	22K	1/10W
R 6253	J24205682	CHIP RES.	RMC1/10T 682J	6.8K	1/10W
R 6254	J24205331	CHIP RES.	RMC1/10T 331J	330	1/10W
R 6255	J24205101	CHIP RES.	RMC1/10T 101J	100	1/10W
R 6256	J24205333	CHIP RES.	RMC1/10T 333J	33K	1/10W
R 6257	J24205474	CHIP RES.	RMC1/10T 474J	470K	1/10W
R 6258	J24205223	CHIP RES.	RMC1/10T 223J	22K	1/10W
R 6259	J24205101	CHIP RES.	RMC1/10T 101J	100	1/10W
R 6260	J24205151	CHIP RES.	RMC1/10T 151J	150	1/10W
R 6261	J24205474	CHIP RES.	RMC1/10T 474J	470K	1/10W
R 6262	J24205223	CHIP RES.	RMC1/10T 223J	22K	1/10W
R 6263	J24205101	CHIP RES.	RMC1/10T 101J	100	1/10W
R 6264	J24205151	CHIP RES.	RMC1/10T 151J	150	1/10W
R 6265	J24205474	CHIP RES.	RMC1/10T 474J	470K	1/10W
R 6266	J24205223	CHIP RES.	RMC1/10T 223J	22K	1/10W
R 6267	J24205101	CHIP RES.	RMC1/10T 101J	100	1/10W
R 6268	J24205151	CHIP RES.	RMC1/10T 151J	150	1/10W
R 6269	J24205474	CHIP RES.	RMC1/10T 474J	470K	1/10W
R 6270	J24205223	CHIP RES.	RMC1/10T 223J	22K	1/10W
R 6271	J24205101	CHIP RES.	RMC1/10T 101J	100	1/10W
R 6272	J24205222	CHIP RES.	RMC1/10T 222J	2.2K	1/10W
R 6273	J24205151	CHIP RES.	RMC1/10T 151J	150	1/10W
R 6274	J24205473	CHIP RES.	RMC1/10T 473J	47K	1/10W
R 6275	J24205680	CHIP RES.	RMC1/10T 680J	68	1/10W
R 6276	J24205471	CHIP RES.	RMC1/10T 471J	470	1/10W
R 6277	J24205473	CHIP RES.	RMC1/10T 473J	47K	1/10W
R 6278	J24205680	CHIP RES.	RMC1/10T 680J	68	1/10W
R 6279	J24205471	CHIP RES.	RMC1/10T 471J	470	1/10W
R 6280	J24205151	CHIP RES.	RMC1/10T 151J	150	1/10W
R 6281	J24205331	CHIP RES.	RMC1/10T 331J	330	1/10W

RX-2 Unit Parts List

ADD	CODE NO	DESCRIPTION	DEVICE	TYP	VAL
R 6282	J24205104	CHIP RES.	RMC1/10T 104J	100K	1/10W
R 6283	J24205221	CHIP RES.	RMC1/10T 221J	220	1/10W
R 6284	J24205101	CHIP RES.	RMC1/10T 101J	100	1/10W
R 6285	J24205681	CHIP RES.	RMC1/10T 681J	680	1/10W
R 6286	J24205153	CHIP RES.	RMC1/10T 153J	15K	1/10W
R 6287	J24205680	CHIP RES.	RMC1/10T 680J	68	1/10W
R 6288	J24205102	CHIP RES.	RMC1/10T 102J	1K	1/10W
R 6289	J24205471	CHIP RES.	RMC1/10T 471J	470	1/10W
R 6290	J24205681	CHIP RES.	RMC1/10T 681J	680	1/10W
R 6291	J24205102	CHIP RES.	RMC1/10T 102J	1K	1/10W
R 6292	J24205102	CHIP RES.	RMC1/10T 102J	1K	1/10W
R 6293	J24205104	CHIP RES.	RMC1/10T 104J	100K	1/10W
R 6294	J24205681	CHIP RES.	RMC1/10T 681J	680	1/10W
R 6295	J24205331	CHIP RES.	RMC1/10T 331J	330	1/10W
R 6296	J24205103	CHIP RES.	RMC1/10T 103J	10K	1/10W
R 6297	J24205392	CHIP RES.	RMC1/10T 392J	3.9K	1/10W
R 6298	J24205221	CHIP RES.	RMC1/10T 221J	220	1/10W
R 6299	J24205470	CHIP RES.	RMC1/10T 470J	47	1/10W
R 6300	J24205332	CHIP RES.	RMC1/10T 332J	3.3K	1/10W
R 6301	J24205152	CHIP RES.	RMC1/10T 152J	1.5K	1/10W
R 6302	J24205150	CHIP RES.	RMC1/10T 150J	15	1/10W
R 6303	J24205330	CHIP RES.	RMC1/10T 330J	33	1/10W
R 6304	J24205331	CHIP RES.	RMC1/10T 331J	330	1/10W
R 6305	J24205150	CHIP RES.	RMC1/10T 150J	15	1/10W
R 6306	J24205331	CHIP RES.	RMC1/10T 331J	330	1/10W
R 6312	J24205102	CHIP RES.	RMC1/10T 102J	1K	1/10W
R 6313	J24205471	CHIP RES.	RMC1/10T 471J	470	1/10W
R 6314	J24205223	CHIP RES.	RMC1/10T 223J	22K	1/10W
R 6315	J24205223	CHIP RES.	RMC1/10T 223J	22K	1/10W
R 6316	J24205223	CHIP RES.	RMC1/10T 223J	22K	1/10W
R 6317	J24205223	CHIP RES.	RMC1/10T 223J	22K	1/10W
R 6318	J24205223	CHIP RES.	RMC1/10T 223J	22K	1/10W
R 6319	J24205223	CHIP RES.	RMC1/10T 223J	22K	1/10W
R 6320	J24205223	CHIP RES.	RMC1/10T 223J	22K	1/10W
R 6321	J24205472	CHIP RES.	RMC1/10T 472J	4.7K	1/10W
R 6322	J24205221	CHIP RES.	RMC1/10T 221J	220	1/10W
R 6323	J24205223	CHIP RES.	RMC1/10T 223J	22K	1/10W
R 6324	J24205682	CHIP RES.	RMC1/10T 682J	6.8K	1/10W
R 6325	J24205471	CHIP RES.	RMC1/10T 471J	470	1/10W
R 6326	J24205101	CHIP RES.	RMC1/10T 101J	100	1/10W
R 6327	J24205000	CHIP RES.	RMC1/10T 000J	0	1/10W
R 6328	J24205473	CHIP RES.	RMC1/10T 473J	47K	1/10W
R 6329	J24205102	CHIP RES.	RMC1/10T 102J	1K	1/10W
R 6330	J24205182	CHIP RES.	RMC1/10T 182J	1.8K	1/10W
R 6331	J24205471	CHIP RES.	RMC1/10T 471J	470	1/10W
R 6332	J24205223	CHIP RES.	RMC1/10T 223J	22K	1/10W
R 6333	J24205223	CHIP RES.	RMC1/10T 223J	22K	1/10W
R 6334	J24205223	CHIP RES.	RMC1/10T 223J	22K	1/10W
R 6335	J24205334	CHIP RES.	RMC1/10T 334J	330K	1/10W
R 6336	J24205104	CHIP RES.	RMC1/10T 104J	100K	1/10W
R 6337	J24205104	CHIP RES.	RMC1/10T 104J	100K	1/10W
R 6338	J24205473	CHIP RES.	RMC1/10T 473J	47K	1/10W
R 6339	J24205684	CHIP RES.	RMC1/10T 684J	680K	1/10W
R 6340	J24205682	CHIP RES.	RMC1/10T 682J	6.8K	1/10W
R 6341	J24205472	CHIP RES.	RMC1/10T 472J	4.7K	1/10W
R 6342	J24205102	CHIP RES.	RMC1/10T 102J	1K	1/10W
R 6343	J24205472	CHIP RES.	RMC1/10T 472J	4.7K	1/10W
R 6344	J24205102	CHIP RES.	RMC1/10T 102J	1K	1/10W
R 6345	J24205224	CHIP RES.	RMC1/10T 224J	220K	1/10W
R 6346	J24205332	CHIP RES.	RMC1/10T 332J	3.3K	1/10W
R 6347	J24205104	CHIP RES.	RMC1/10T 104J	100K	1/10W
R 6348	J24205223	CHIP RES.	RMC1/10T 223J	22K	1/10W
R 6349	J24205332	CHIP RES.	RMC1/10T 332J	3.3K	1/10W
R 6350	J24205000	CHIP RES.	RMC1/10T 000J	0	1/10W
R 6351	J24205000	CHIP RES.	RMC1/10T 000J	0	1/10W
R 6352	J24205000	CHIP RES.	RMC1/10T 000J	0	1/10W
R 6353	J24205000	CHIP RES.	RMC1/10T 000J	0	1/10W
R 6354	J24205000	CHIP RES.	RMC1/10T 000J	0	1/10W
R 6355	J24205000	CHIP RES.	RMC1/10T 000J	0	1/10W
R 6356	J24205000	CHIP RES.	RMC1/10T 000J	0	1/10W
R 6357	J24205000	CHIP RES.	RMC1/10T 000J	0	1/10W
R 6358	J24205223	CHIP RES.	RMC1/10T 223J	22K	1/10W
R 6359	J24205682	CHIP RES.	RMC1/10T 682J	6.8K	1/10W
R 6360	J24205221	CHIP RES.	RMC1/10T 221J	220	1/10W
R 6362	J24205470	CHIP RES.	RMC1/10T 470J	47	1/10W
R 6363	J24205000	CHIP RES.	RMC1/10T 000J	0	1/10W
R 6364	J24205000	CHIP RES.	RMC1/10T 000J	0	1/10W
R 6365	J24205101	CHIP RES.	RMC1/10T 101J	100	1/10W
R 6367	J24205000	CHIP RES.	RMC1/10T 000J	0	1/10W
R 6368	J24205470	CHIP RES.	RMC1/10T 470J	47	1/10W
R 6369	J24205222	CHIP RES.	RMC1/10T 222J	2.2K	1/10W
R 6370	J24205223	CHIP RES.	RMC1/10T 223J	22K	1/10W
R 6371	J24205153	CHIP RES.	RMC1/10T 153J	15K	1/10W

For Service Manuals Contact
MAURITRON TECHNICAL SERVICES
 8 Cherry Tree Rd, Chinnor
 Oxon OX9 4QY
 Tel: 01844-351694 Fax: 01844-352954
 Email: enquiries@mauratron.co.uk

RX-2 Unit Parts List

ADD	CODE NO	DESCRIPTION	DEVICE	TYP	VAL
R 6372	J24205332	CHIP RES.	RMC1/10T 332J	3.3K	1/10W
R 6373	J24205332	CHIP RES.	RMC1/10T 332J	3.3K	1/10W
R 6374	J24205000	CHIP RES.	RMC1/10T 000J	0	1/10W
R 6375	J24205152	CHIP RES.	RMC1/10T 152J	1.5K	1/10W
R 6376	J24205472	CHIP RES.	RMC1/10T 472J	4.7K	1/10W
R 6377	J24205224	CHIP RES.	RMC1/10T 224J	220K	1/10W
R 6378	J24205332	CHIP RES.	RMC1/10T 332J	3.3K	1/10W
R 6379	J07225101	CARBON FILM RES.	RD16TPJ101 100	100	1/8W
R 6380	J24205104	CHIP RES.	RMC1/10T 104J	100K	1/10W
R 6381	J24205104	CHIP RES.	RMC1/10T 104J	100K	1/10W
R 6382	J24205104	CHIP RES.	RMC1/10T 104J	100K	1/10W
R 6383	J24205102	CHIP RES.	RMC1/10T 102J	1K	1/10W
R 6384	J24205471	CHIP RES.	RMC1/10T 471J	470	1/10W
R 6385	J24205103	CHIP RES.	RMC1/10T 103J	10K	1/10W
R 6386	J24205153	CHIP RES.	RMC1/10T 153J	15K	1/10W
R 6387	J24205153	CHIP RES.	RMC1/10T 153J	15K	1/10W
R 6388	J24205221	CHIP RES.	RMC1/10T 221J	220	1/10W
T 6001	L0020883	COIL	4-1 2001F		
T 6002	L0020883	COIL	4-1 2001F		
T 6003	L0021125A	COIL	48.6M R12-9420A		
T 6004	L0021943	COIL	48.64M R12-J767A		
T 6005	L0021943	COIL	48.64M R12-J767A		
T 6006	L0021125A	COIL	48.6M R12-9420A		
T 6007	L0020788A	COIL	4-1 2D3 TR6X3		
T 6008	L0021936	COIL	7.68M R12-J770A		
T 6009	L0021937	COIL	7.68M R12-J769A		
T 6010	L0021937	COIL	7.68M R12-J769A		
T 6011	L0021937	COIL	7.68M R12-J769A		
T 6012	L0020788A	COIL	4-1 2D3 TR6X3		
T 6013	L0021737	COIL	455K R12-F777A		
T 6014	L0190002	COIL	455K		
T 6015	L0021737	COIL	455K R12-F777A		
T 6016	L0190002	COIL	455K		
T 6017	L0190026	COIL	455K R12-5898C		
T 6018	L0021936	COIL	7.68M R12-J770A		
T 6019	L0021937	COIL	7.68M R12-J769A		
T 6020	L0021936	COIL	7.68M R12-J770A		
T 6021	L0021199	COIL	8.20M R12-4043A		
T 6023	L0021938	COIL	23.04M R12-H958A		
T 6024	L0021938	COIL	23.04M R12-H958A		
T 6025	L0021939	COIL	46.08M R12-H957A		
T 6026	L0021939	COIL	46.08M R12-H957A		
T 6027	L0021940	COIL	5.12M R12-H959A		
T 6028	L0021484	COIL			
T 6029	L0021163	COIL	10.7M R12-4264A		
T 6030	L0021941	COIL	40.96M R12-J771A		
T 6031	L0021941	COIL	40.96M R12-J771A		
T 6032	L0021941	COIL	40.96M R12-J771A		
TC6001	K91000029	TRIMMER CAP.	ECV1ZW20X53T 20PF	20p	
TC6002	K91000029	TRIMMER CAP.	ECV1ZW20X53T 20PF	20p	
TC6003	K91000029	TRIMMER CAP.	ECV1ZW20X53T 20PF	20p	
TC6004	K91000030	TRIMMER CAP.	ECV1ZW40X53T 40PF	40p	
TC6005	K91000029	TRIMMER CAP.	ECV1ZW20X53T 20PF	20p	
TC6006	K91000059	TRIMMER CAP.	ECV1ZW04X53T 4PF	4pF	
TC6007	K91000055	TRIMMER CAP.	ECV1ZW06X53T 6PF	6pF	
TC6008	K91000055	TRIMMER CAP.	ECV1ZW06X53T 6PF	6pF	
TC6009	K91000055	TRIMMER CAP.	ECV1ZW06X53T 6PF	6pF	
TH6001	G9090026	THERMISTOR	112201-2		
TH6002	G9090026	THERMISTOR	112201-2		
TH6003	G9090023	THERMISTOR	SDT04		
TH6004	G9090008	THERMISTOR	112102-2		
TP6001	Q5000026	TP-F	TP-F IPS-1032		
TP6002	Q5000026	TP-F	TP-F IPS-1032		
TP6003	Q5000026	TP-F	TP-F IPS-1032		
TP6004	Q5000026	TP-F	TP-F IPS-1032		
TP6005	Q5000026	TP-F	TP-F IPS-1032		
TP6006	Q5000026	TP-F	TP-F IPS-1032		
TP6007	Q5000026	TP-F	TP-F IPS-1032		
TP6008	Q5000026	TP-F	TP-F IPS-1032		
TP6009	Q5000026	TP-F	TP-F IPS-1032		
TP6010	Q5000026	TP-F	TP-F IPS-1032		
TP6011	Q5000026	TP-F	TP-F IPS-1032		
TP6012	Q5000026	TP-F	TP-F IPS-1032		
VR6001	J51745471	POT.	H0651A005-470B	470P	
VR6002	J51745471	POT.	H0651A005-470B	470B	
VR6003	J51745471	POT.	H0651A005-470B	470B	
VR6004	J51745471	POT.	H0651A005-470B	470B	
VR6005	J51762332	POT.	H0521A110A-3.3KB	3.3KB	
VR6006	J51745223	POT.	H0651A015-22KB	22KB	
VR6007	J51762333	POT.	H0521A116A-33KB	33KB	
VR6008	J51745223	POT.	H0651A015-22KB	22KB	
X 6001	H0102920	XTAL		8.1365MHZ	
X 6002	H0102921	XTAL		8.1335MHZ	

RX-2 Unit Parts List

ADD	CODE NO	DESCRIPTION	DEVICE	TYP VAL
X 6003	H0102922	XTAL		8.1352MHZ
X 6004	H0102923	XTAL		40.96MHZ
X 6005	H0102924	XTAL		7.68MHZ
X 6006	H0102925	XTAL		48.185MHZ
XF6001	H1102151	XTAL	48N10B1	
XF6002	H1102151	XTAL	48N10B1	

For Service Manuals Contact
MAURITRON TECHNICAL SERVICES
8 Cherry Tree Rd, Chinnor
Oxon OX9 4QY
Tel: 01844-351634 Fax: 01844-352554
Email: enquiries@mauritron.co.uk

For Service Manuals Contact
MAURITRON TECHNICAL SERVICES
Oxon OX9 4QY
Tel: 01844-351694 Fax: 01844-352554
Email: enquiries@mauritron.co.uk

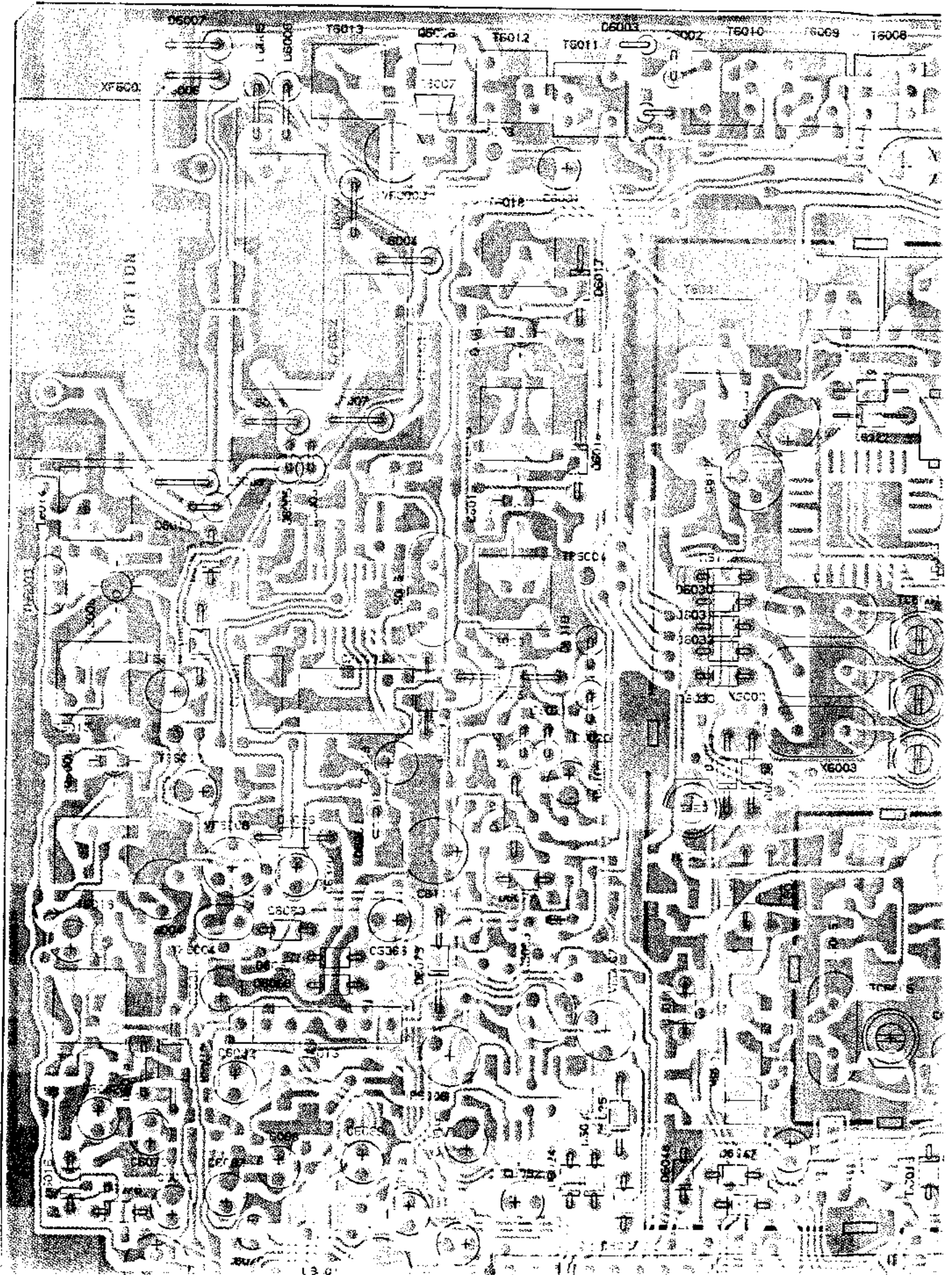

For Service Manuals Contact
MAURITRON TECHNICAL SERVICES
 8 Cherry Tree Rd, Chirnor
 Oxon OX9 4QY
 Tel: 01844-351694 Fax: 01844-352554
 Email: enquiries@mauritron.co.uk

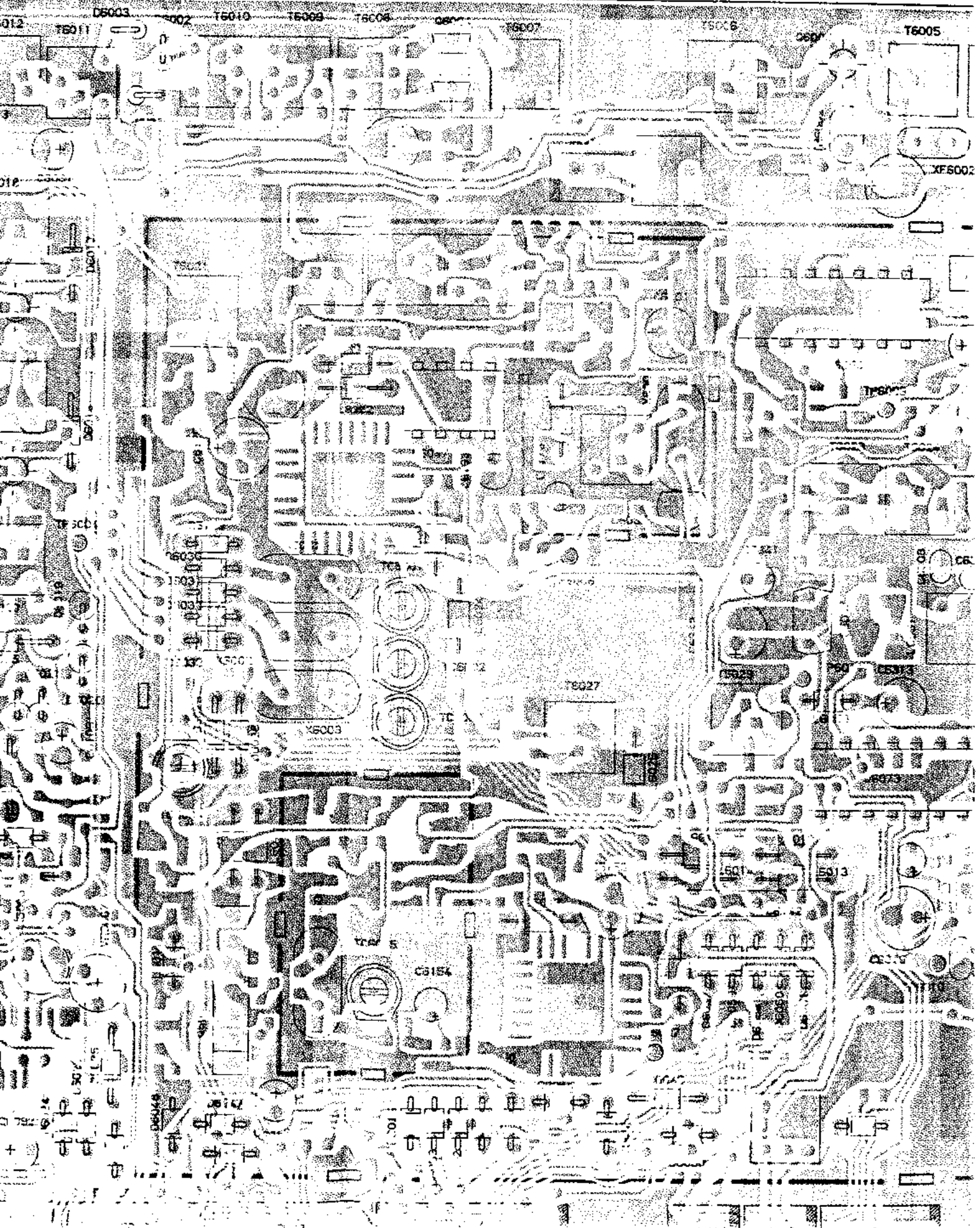

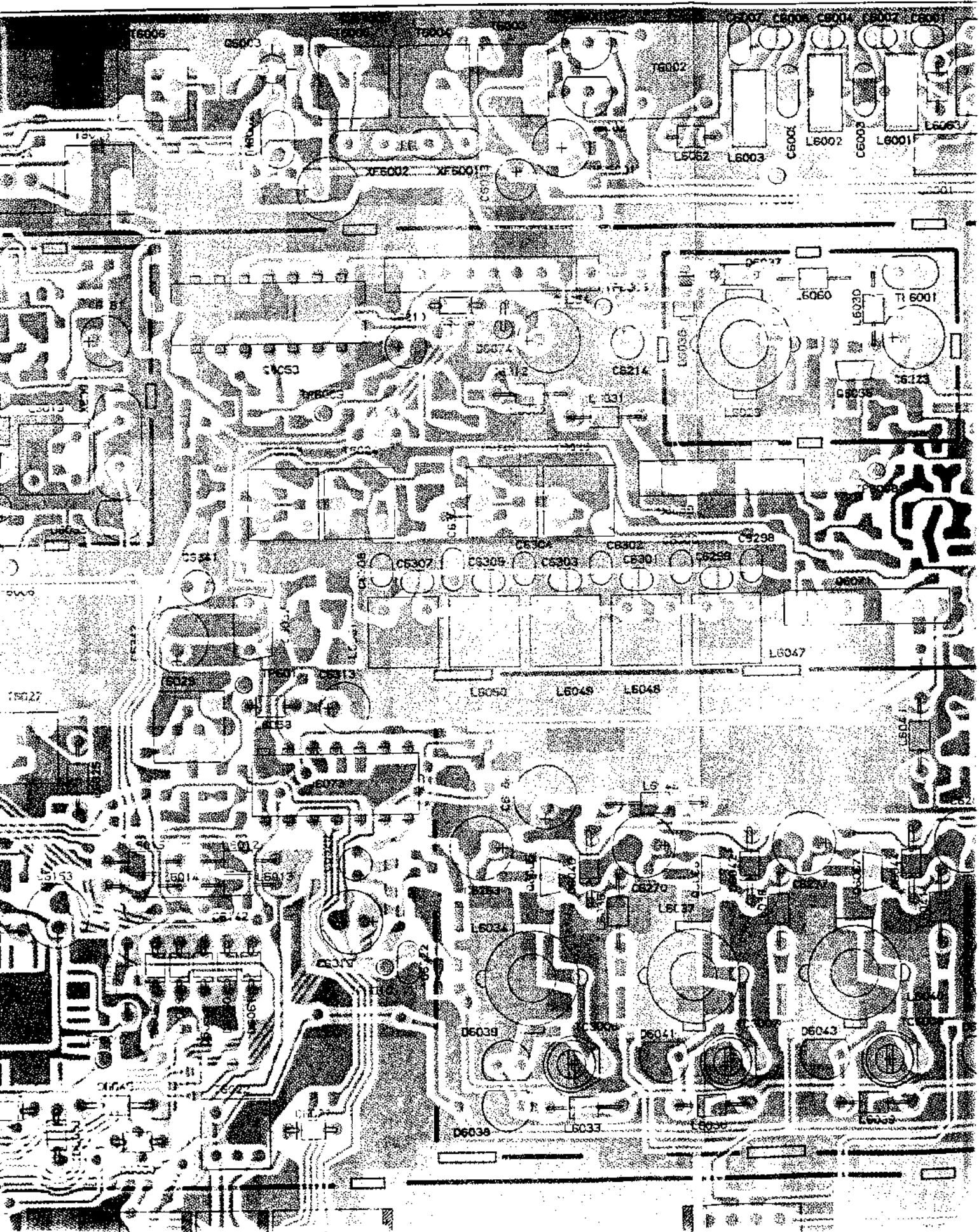

RX-2 Unit Board Layout

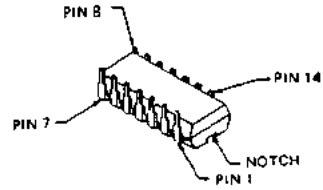
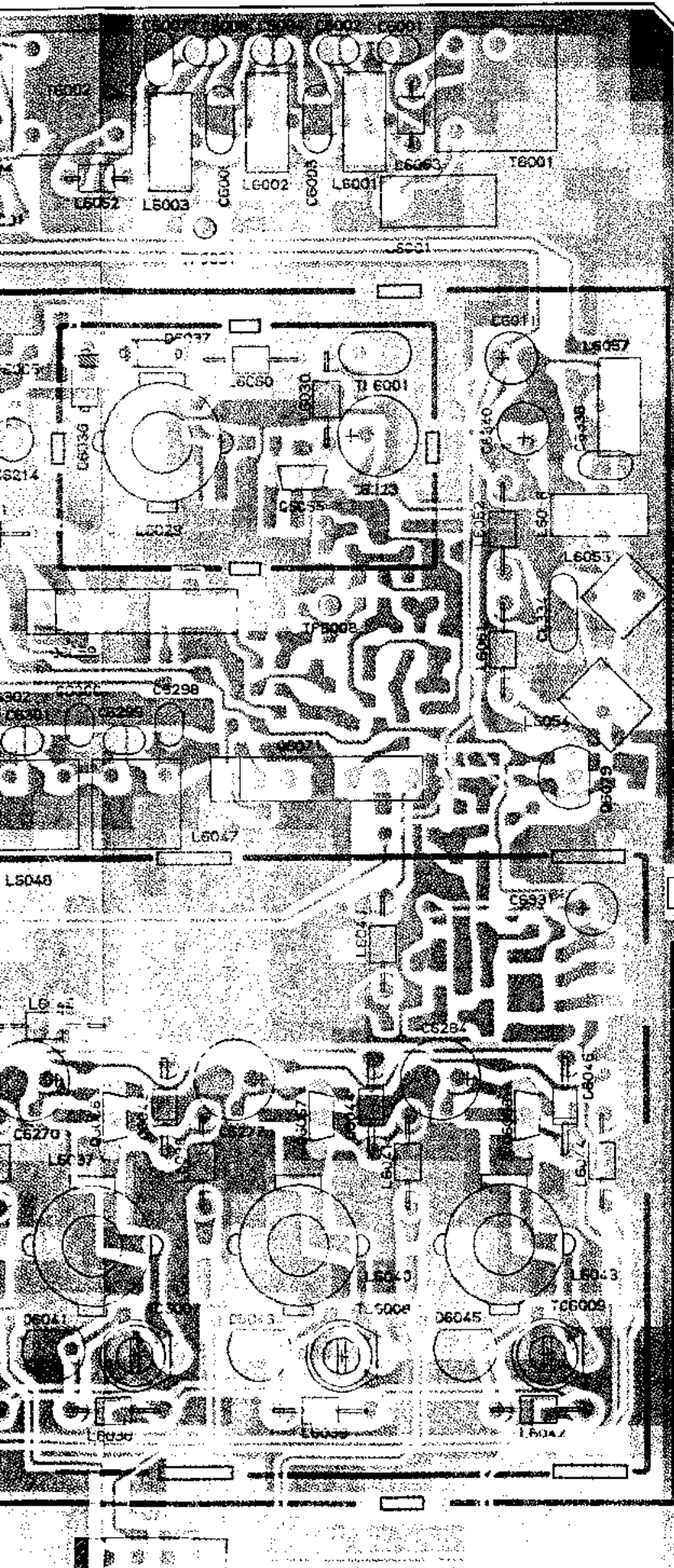

CX-7925B
(Q6073)
MC14013BCP
(Q6053)

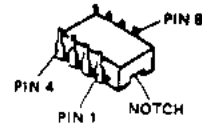

µPB555C
(Q6047)

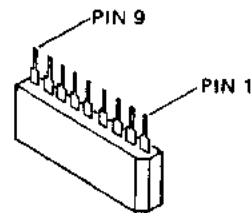

TC5081AP
(Q6054)

For Service Manuals Contact
MAURITRON TECHNICAL SERVICES
8 Cherry Tree Rd, Chinnor
Oxon OX9 4QY
Tel: 01844-351694 Fax: 01844-352554
Email: enquiries@mauritron.co.uk

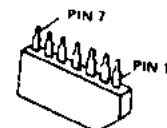

µPC1037H
(Q6015, Q6034,
Q6059, Q6071)

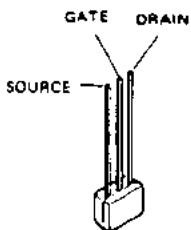
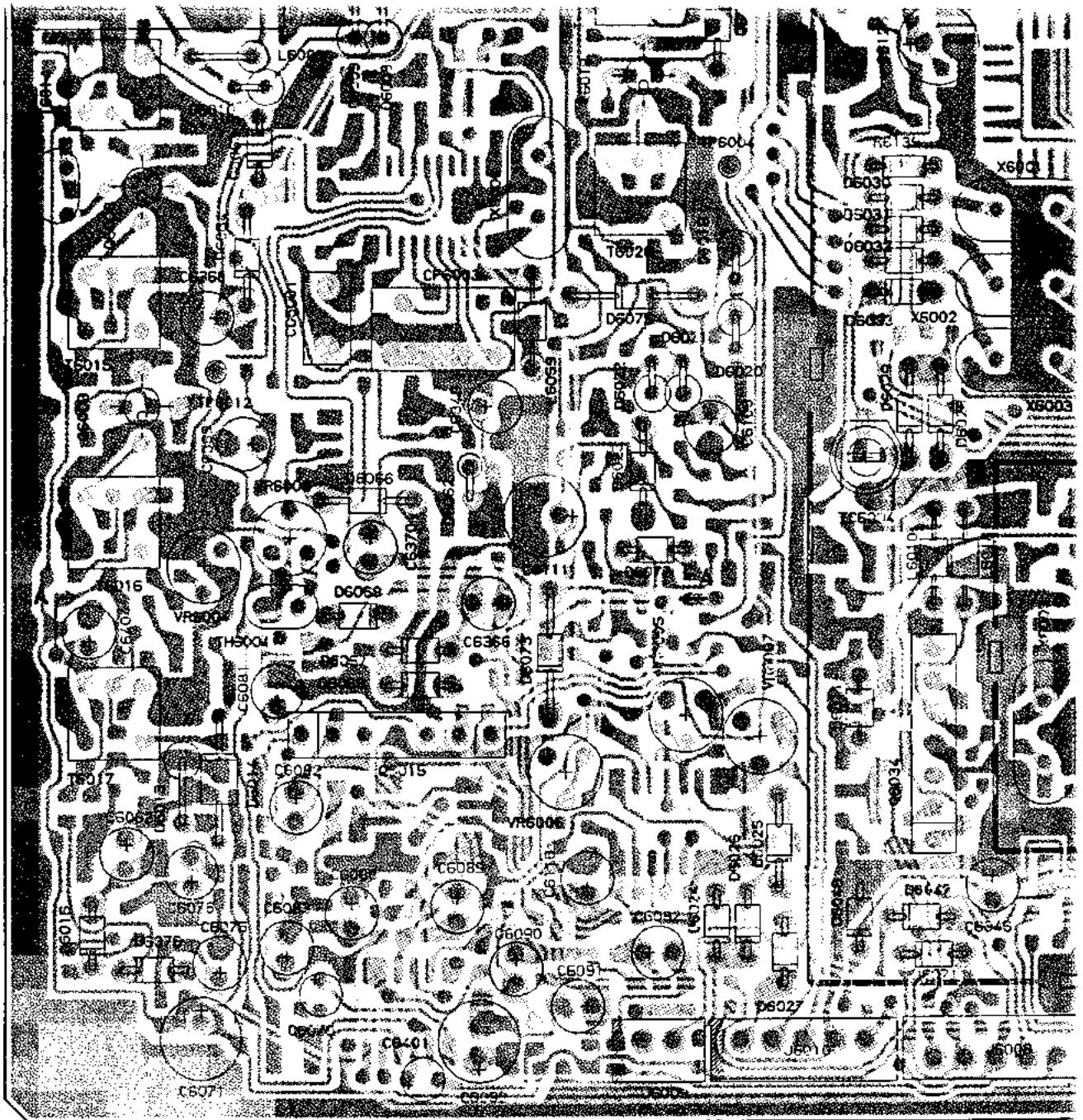

2SK507F

- (Q6004, Q6005,
Q6006, Q6007)

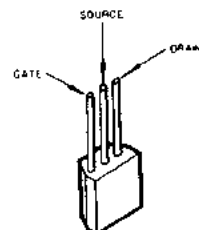

2SK192A-BL

- (Q6055, Q6065, Q6066,
Q6067, Q6068)

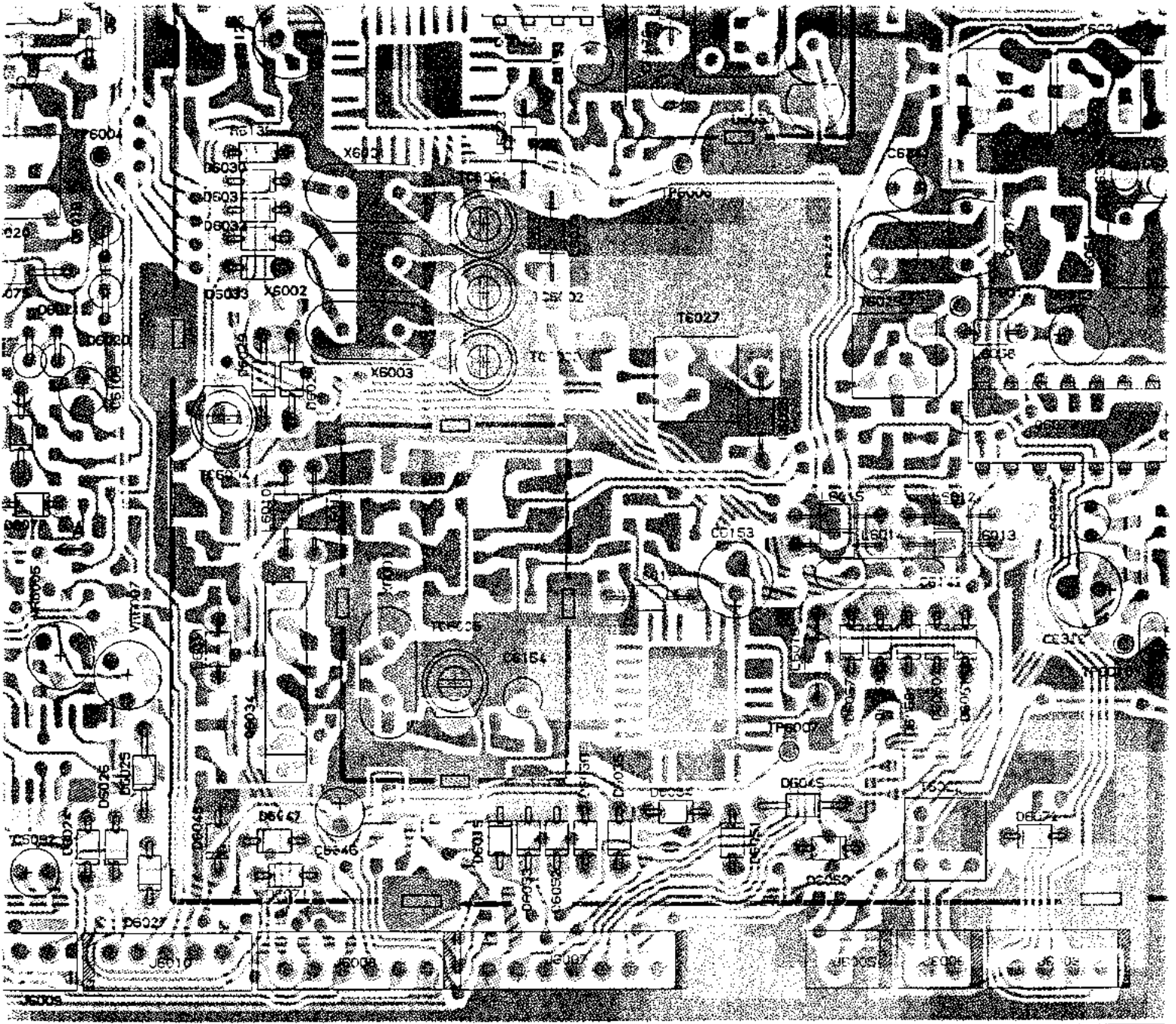

For Service Manuals Contact
MAURITRON TECHNICAL SERVICES
 8 Cherry Tree Rd, Chinnor
 Oxon OX9 4QY
 Tel: 01844-351694 Fax: 01844-352554
 Email: enquiries@mauritron.co.uk

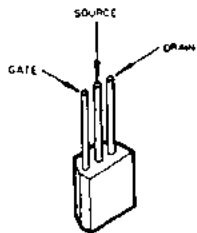

SK192A-BL
 (Q6055, Q6065, Q6066,
 Q6067, Q6068)

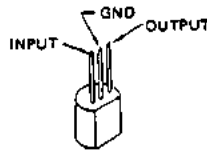

µPC78L05
 (Q6087)

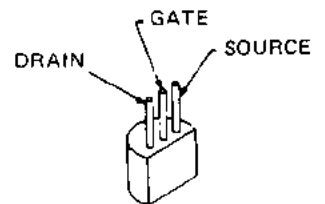

2SK125
 (Q6001, Q6002)

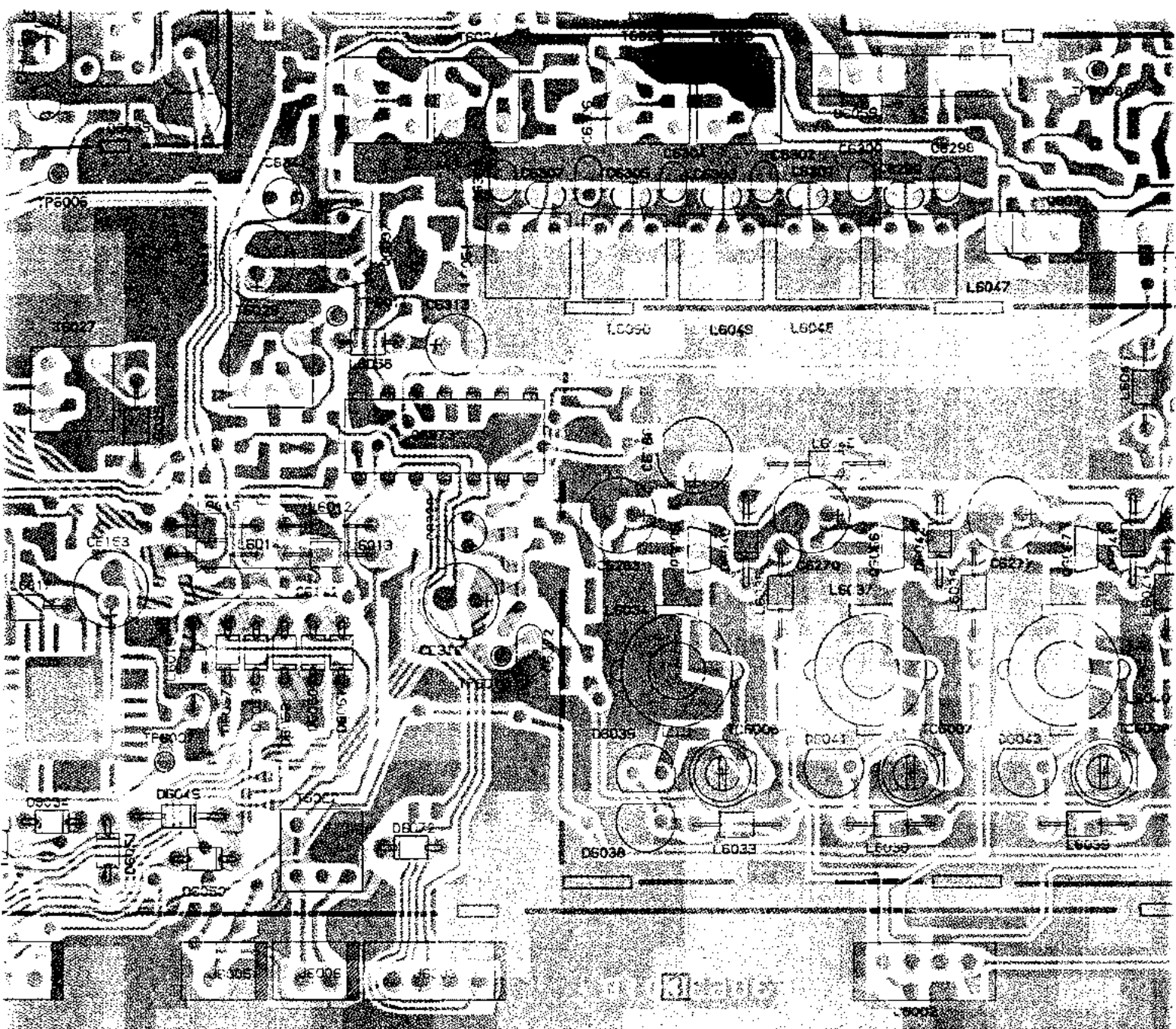

(obverse view of ")

ND
OUTPUT

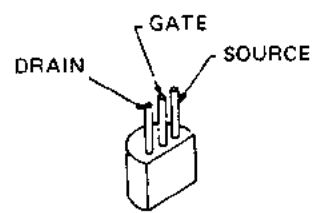

2SK125
(Q6001, Q6002)

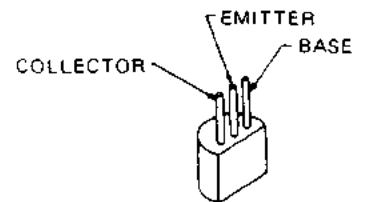

2SC3355
(Q6079)

.05
37)

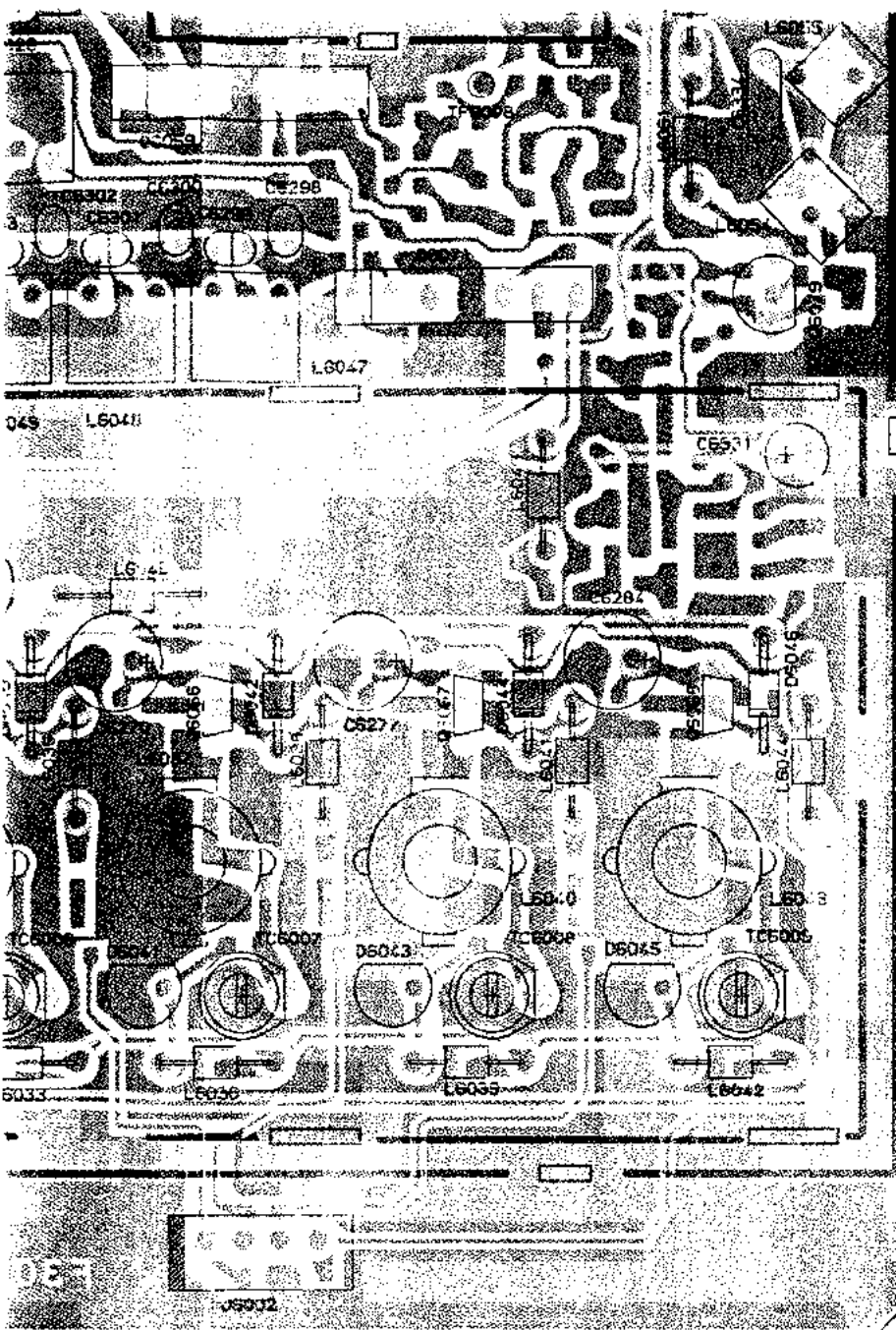

(obverse view of "component" side)

μPB555C
(Q6047)

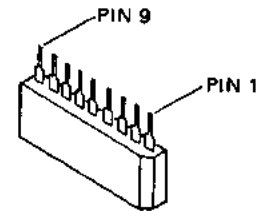

TC5081AP
(Q6054)

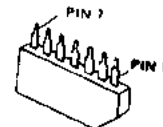

μPC1037H
(Q6015, Q6034,
Q6059, Q6071)

For Service Manuals Contact
MAURITRON TECHNICAL SERVICES
8 Cherry Tree Rd, Chinnor
Oxon OX9 4QY
Tel: 01844-351694 Fax: 01844-352554
Email: enquiries@mauritron.co.uk

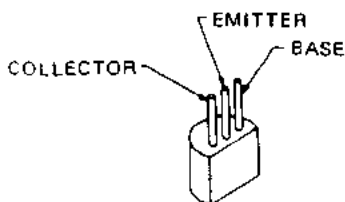

2SC3355
(Q6079)

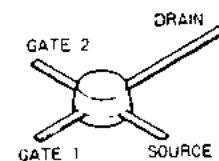

3SK74L
(Q6003, Q6008, Q6009,
Q6018, Q6019)

For Service Manuals Contact
MAURITRON TECHNICAL SERVICES
 8 Cherry Tree Rd. Chinnor
 Oxon OX9 4QY
Tel: 01844 351634 Fax: 01844 352554
Email: enquiries@mauritron.co.uk

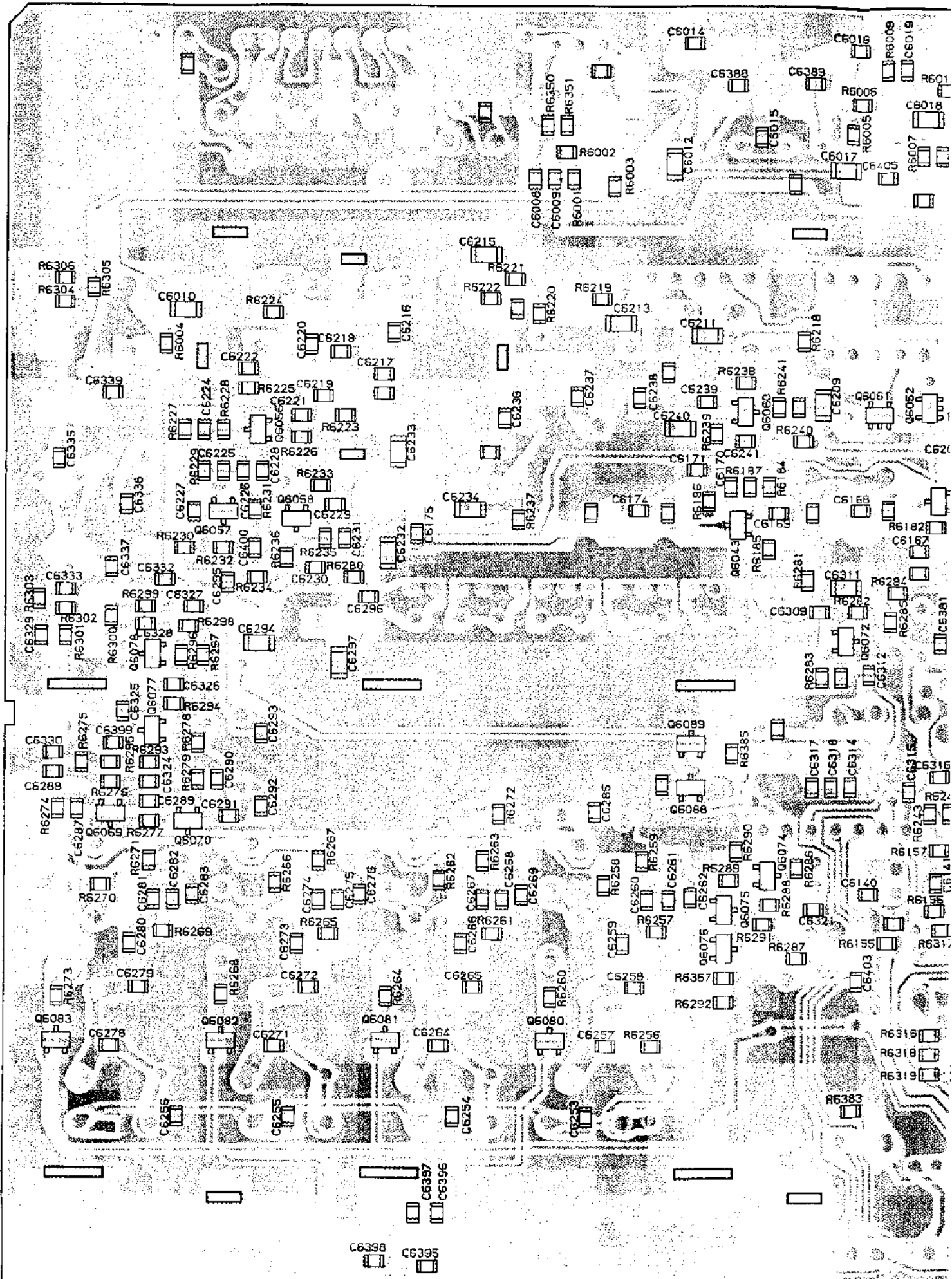

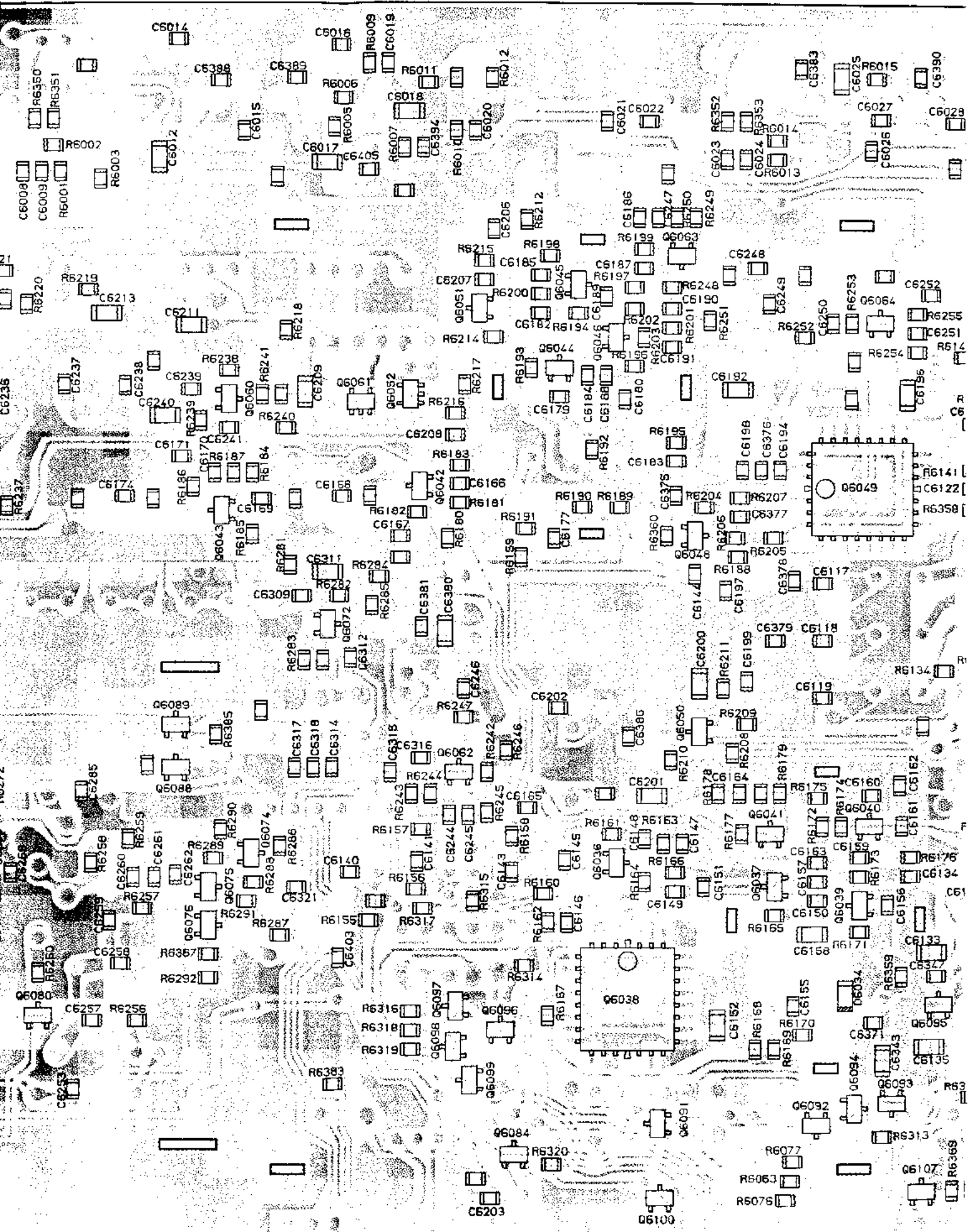



RX-2 Unit Board Layout

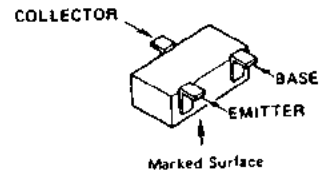
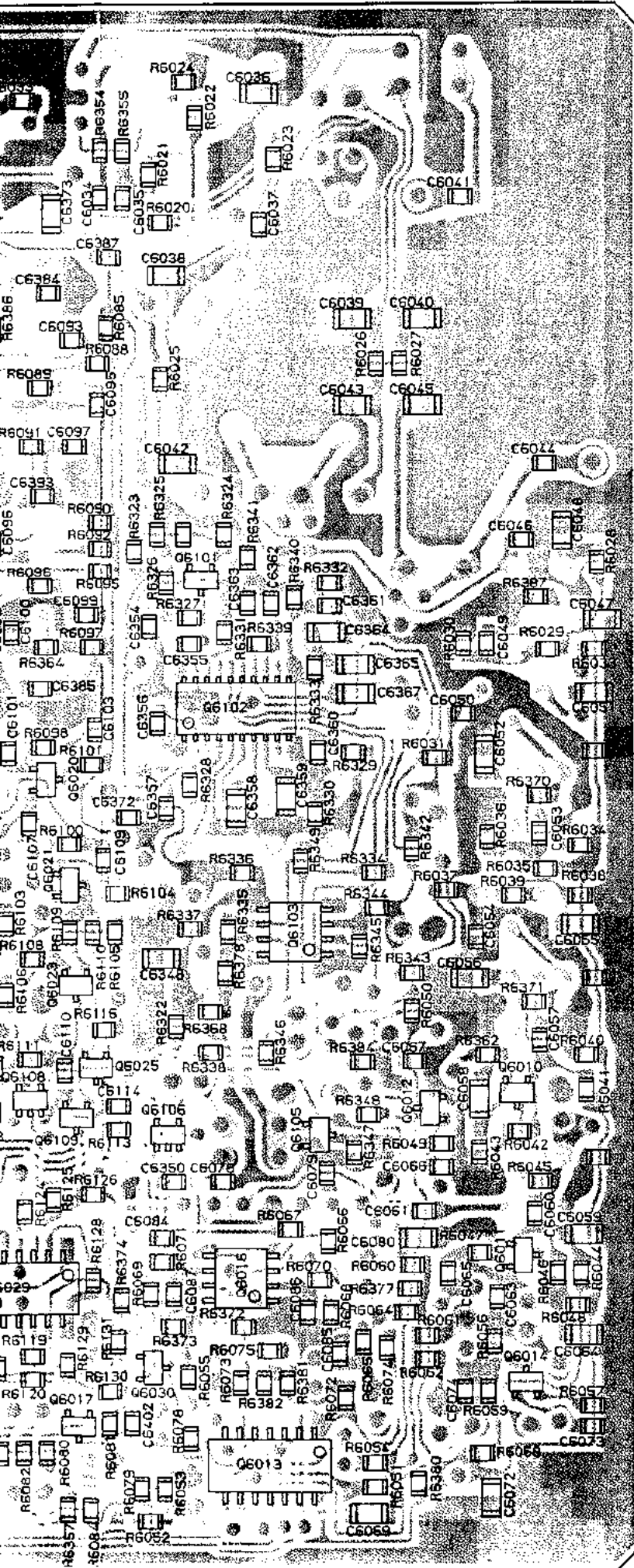

FA1A4M(L33)

(Q6080, Q6081, Q6082, Q6083,
Q6084, Q6088, Q6091, Q6095,
Q6096, Q6097, Q6098, Q6099,
Q6100, Q6105, Q6107, Q6109,
Q6110)

FN1A4M(M33)

(Q6092, Q6093, Q6094)

DTA143EK (T96)

(Q6089)

2SA1162GR (SG)

(Q6023, Q6025)

2SC2619 (FB)

(Q6020, Q6032, Q6033, Q6040,
Q6041, Q6042, Q6043, Q6045,
Q6046, Q6050, Q6063, Q6064,
Q6101)

2SC2620 (QB)

(Q6010, Q6031, Q6039, Q6044,
Q6057, Q6058, Q6072)

2SC2712GR (LG)

(Q6011, Q6012, Q6014, Q6017,
Q6021, Q6022, Q6024, Q6028,
Q6030, Q6035, Q6036, Q6037,
Q6048, Q6051, Q6060, Q6062,
Q6075, Q6076)

2SC2714Y (JY)

(Q6077, Q6078)

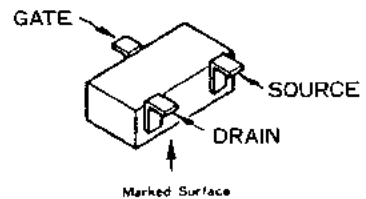

2SK208Y (JY)

(Q6074)



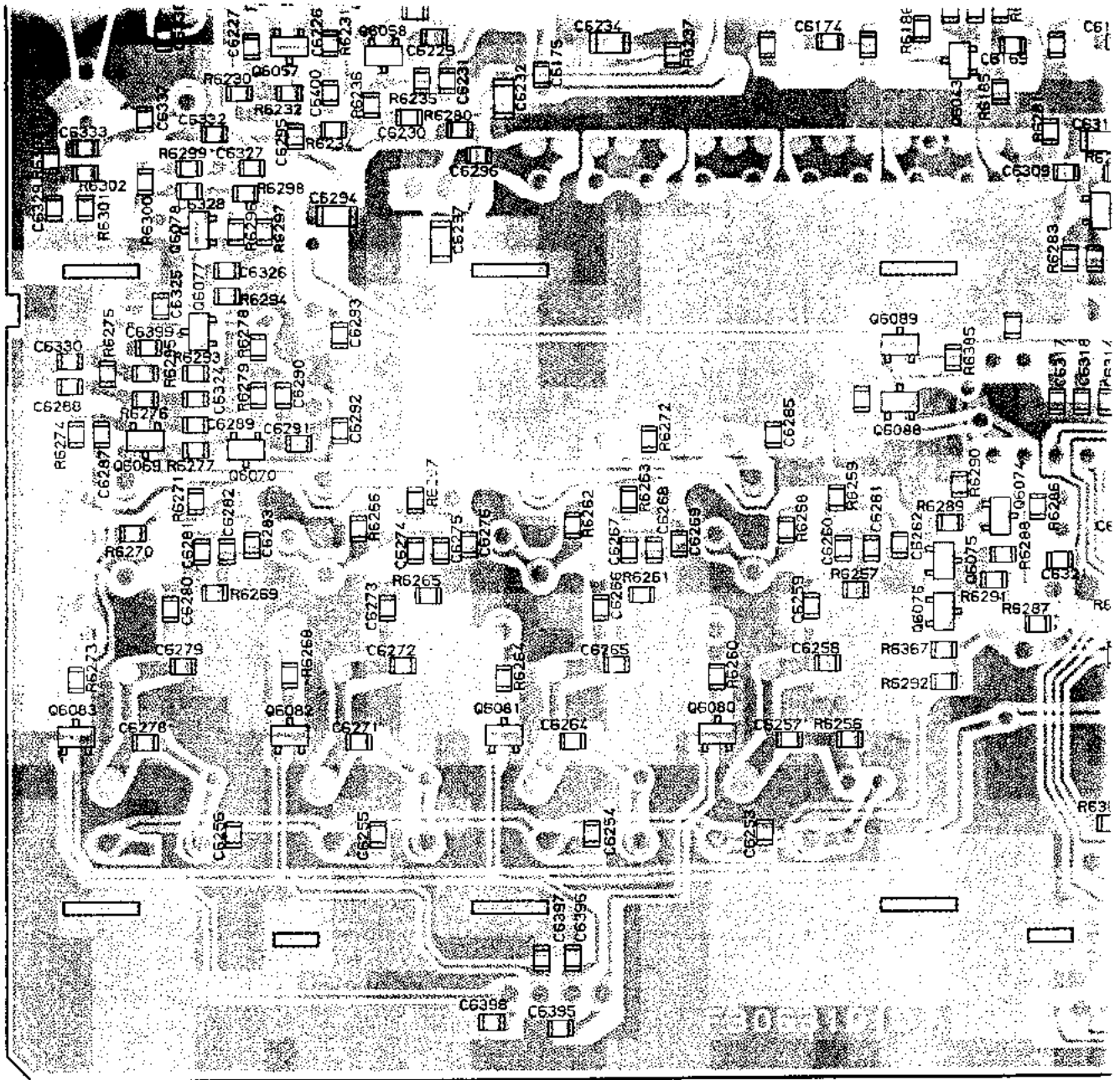

For Service Manuals Contact
MAURITRON TECHNICAL SERVICES
 8 Cherry Tree Rd, Chinnor
 Oxon OX9 4QY
 Tel: 01844-351694 Fax: 01844-352554
 Email: enquiries@mauritron.co.uk

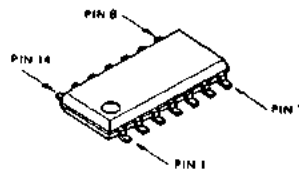

LC4066BM
 (Q6013)
 NJM2902M
 (Q6029)

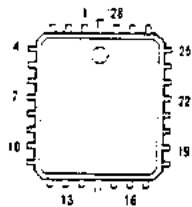

MC145163SL
 (Q6038, Q6049)

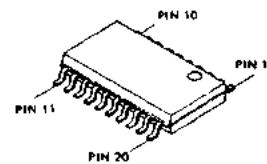

TK10487MT1
 (Q6102)

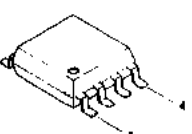
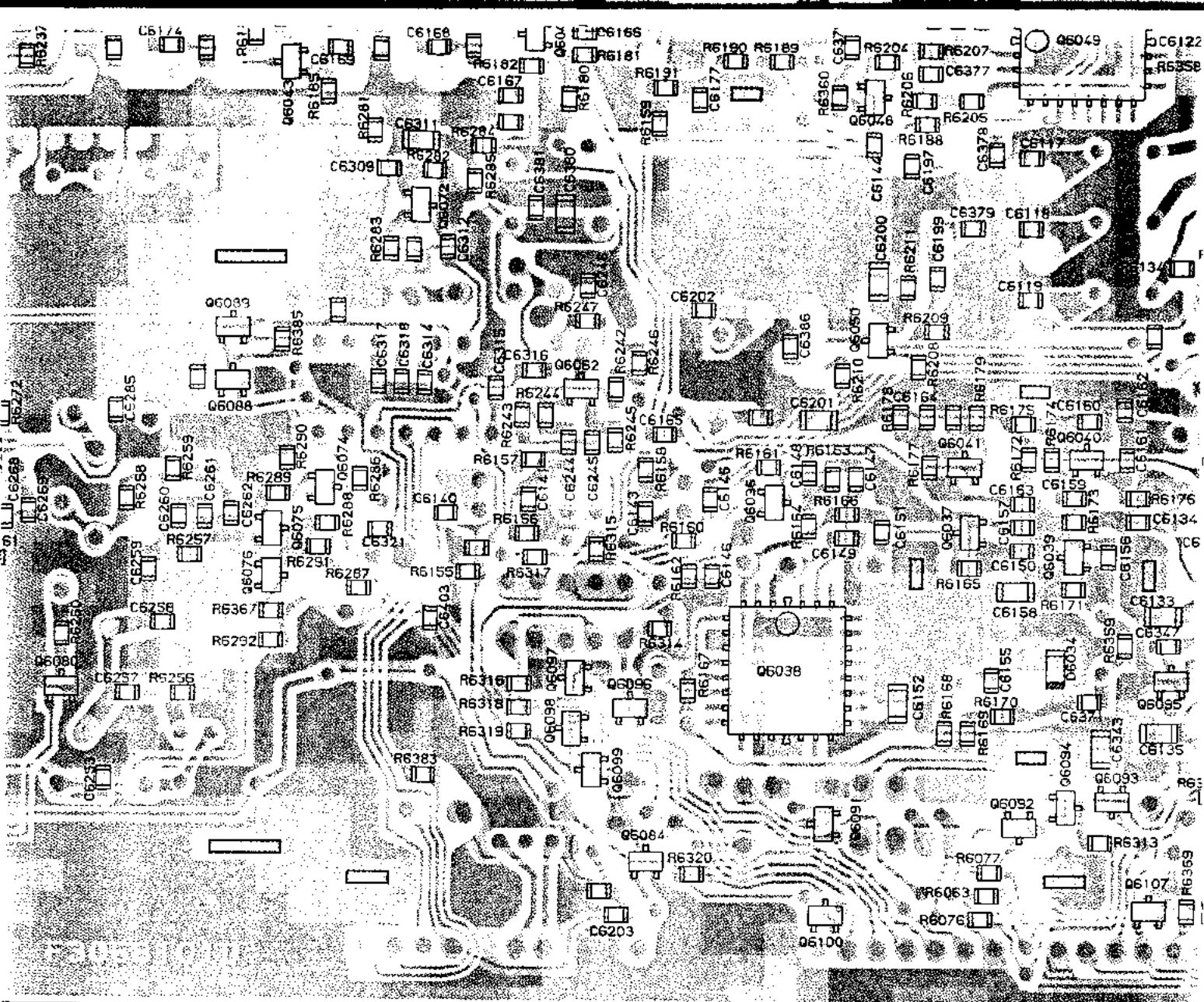

NJM2904M
(Q6016, Q6103)

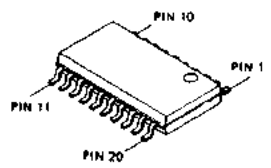

TK10487MT1
(Q6102)

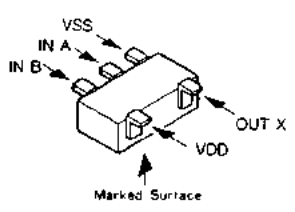

TC4S81F (C2)
(Q6108)

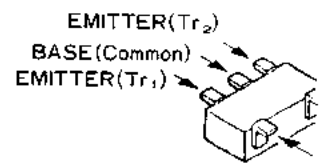

Marked Sur
FMC3(T)
(Q6106)

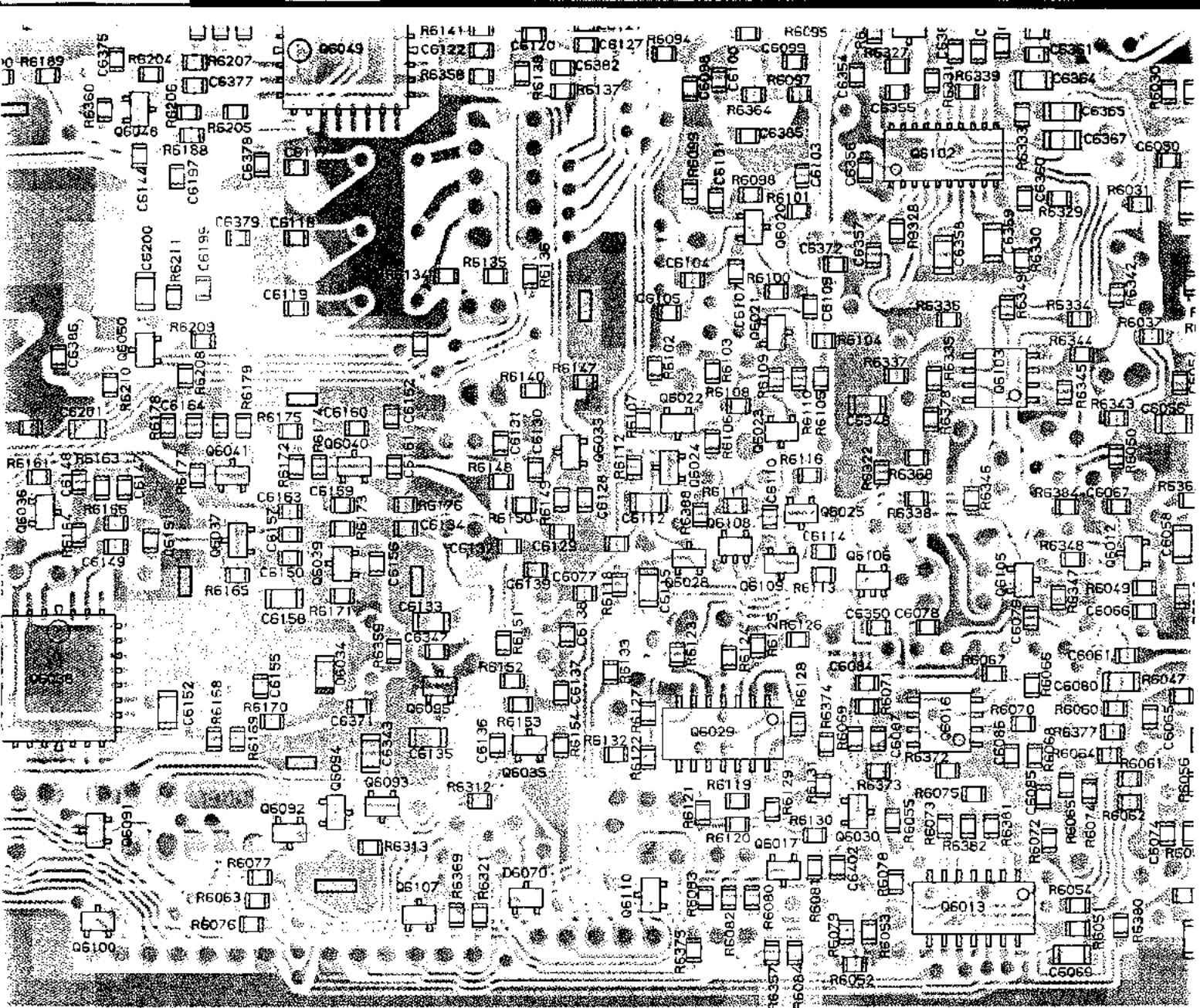

(obverse view of "chip-only")

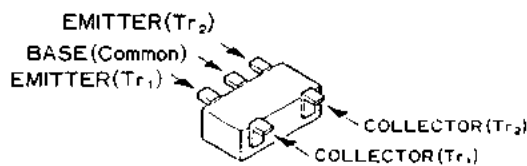

Marked Surface

FMC3 (T99)
(Q6106)

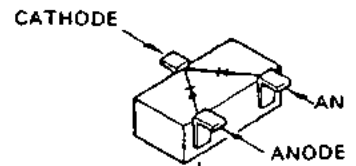

Marked Surface

ISS184 (B3)
(D6070)

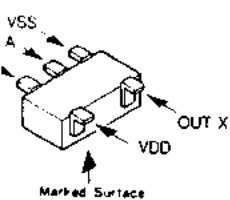

Marked Surface

TC4S81F (C2)
(Q6108)

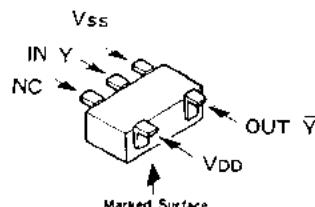

Marked Surface

TC4S584F (CA)
(Q6052, Q6061)

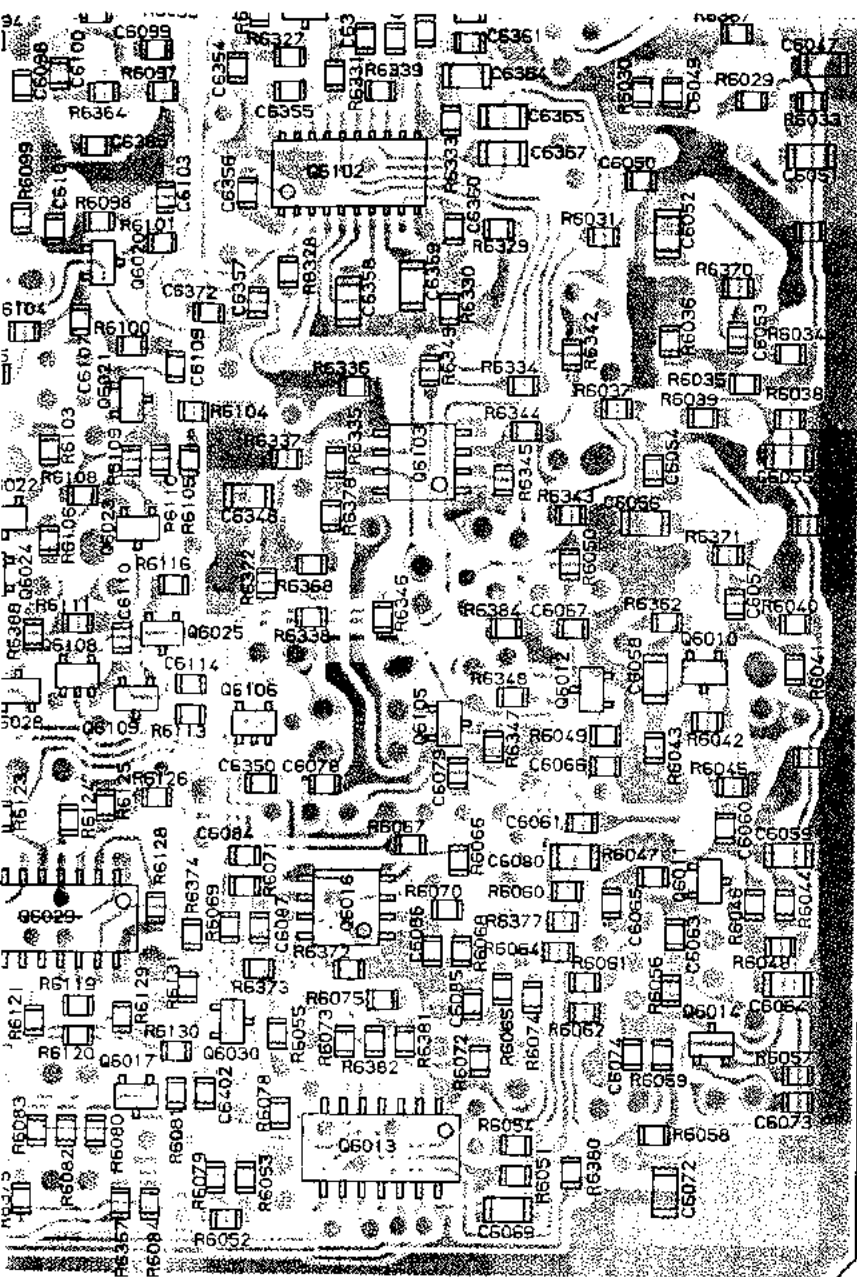

(obverse view of "chip-only" side)

- (Q6041, Q6042, Q6043, Q6044, Q6046, Q6050, Q6063, Q6064, Q6101)
- 2SC2620(QB)
- (Q6010, Q6031, Q6039, Q6044, Q6057, Q6058, Q6072)
- 2SC2712GR(LG)
- (Q6011, Q6012, Q6014, Q6017, Q6021, Q6022, Q6024, Q6028, Q6030, Q6035, Q6036, Q6037, Q6048, Q6051, Q6060, Q6062, Q6075, Q6076)
- 2SC2714Y(JY)
- (Q6077, Q6078)

For Service Manuals Contact
MAURITRON TECHNICAL SERVICES
 8 Cherry Tree Rd, Chinnor
 Oxon OX9 4QY
 Tel: 01844-351694 Fax: 01844-352554
 Email: enquiries@mauritron.co.uk

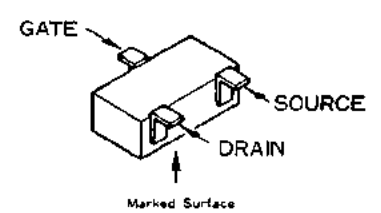

2SK208Y(JY)
(Q6074)

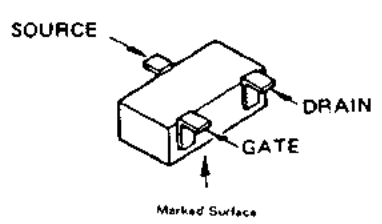

2SK302GR(TG)
(Q6069)
2SK302Y(TY)
(Q6056, Q6070)

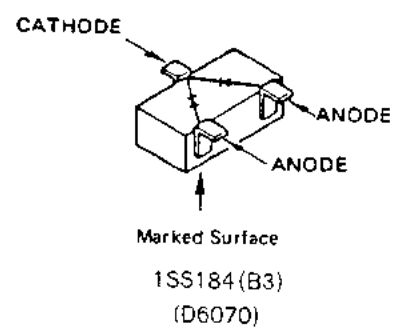

1SS184(B3)
(D6070)

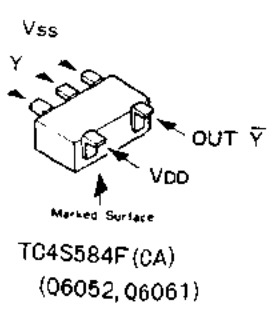

TC4S584F(CA)
(Q6052, Q6061)

RX2-UNIT
F3063101D

For Service Manuals Contact
MAURITRON TECHNICAL SERVICES
8 Cherry Tree Rd, Chinnor
Oxon OX9 4QY
Tel: 01844-351694 Fax: 01844-352554
Email: enquiries@mauritron.co.uk

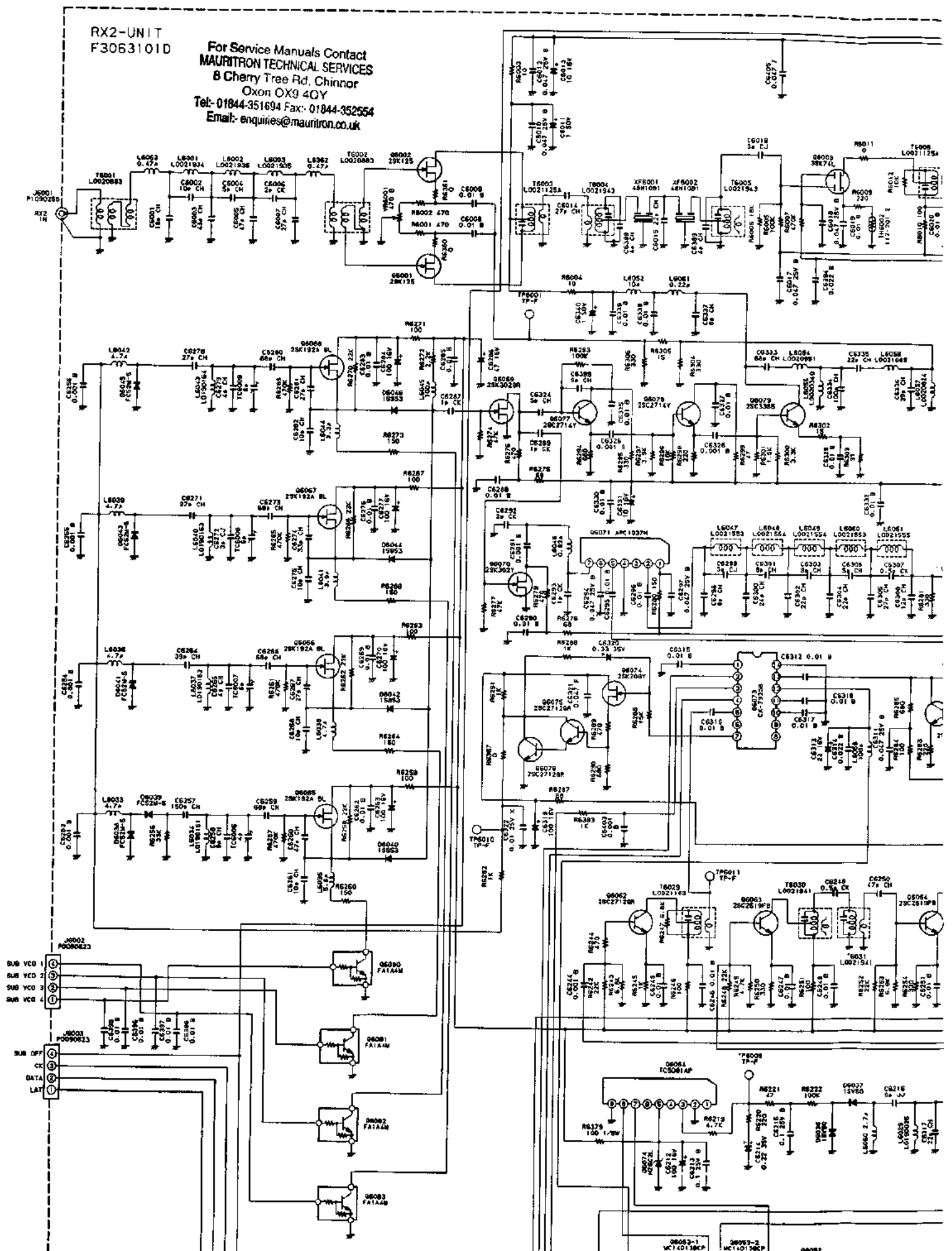

For Service Manual Contact
 MAURITRON TECHNICAL SERVICES
 8 Cherry Tree Rd, Chinnor
 Oxon OX2 4QY
 Tel: 01844 351694 Fax: 01844 352554
 Email: enquiries@mauritron.co.uk

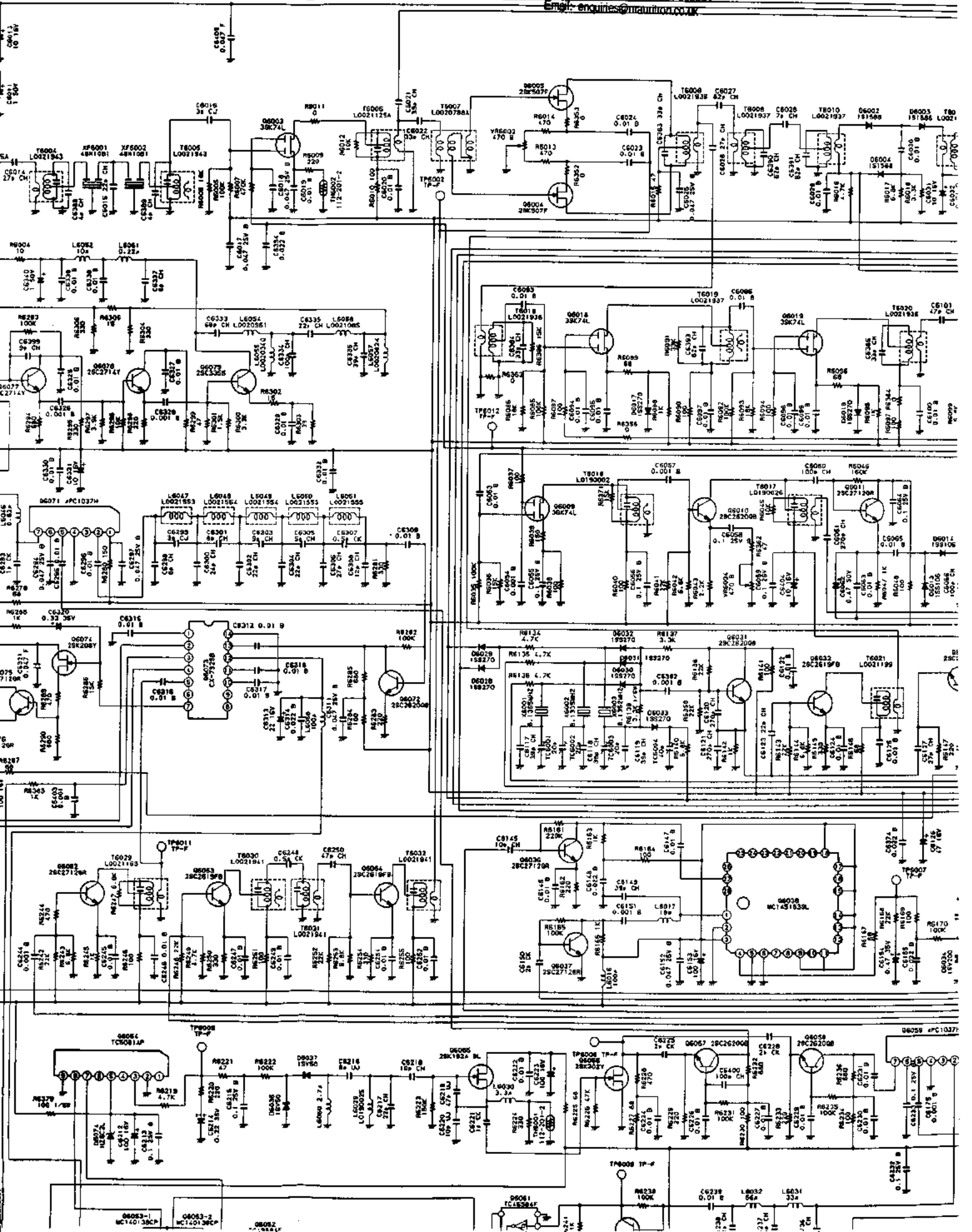

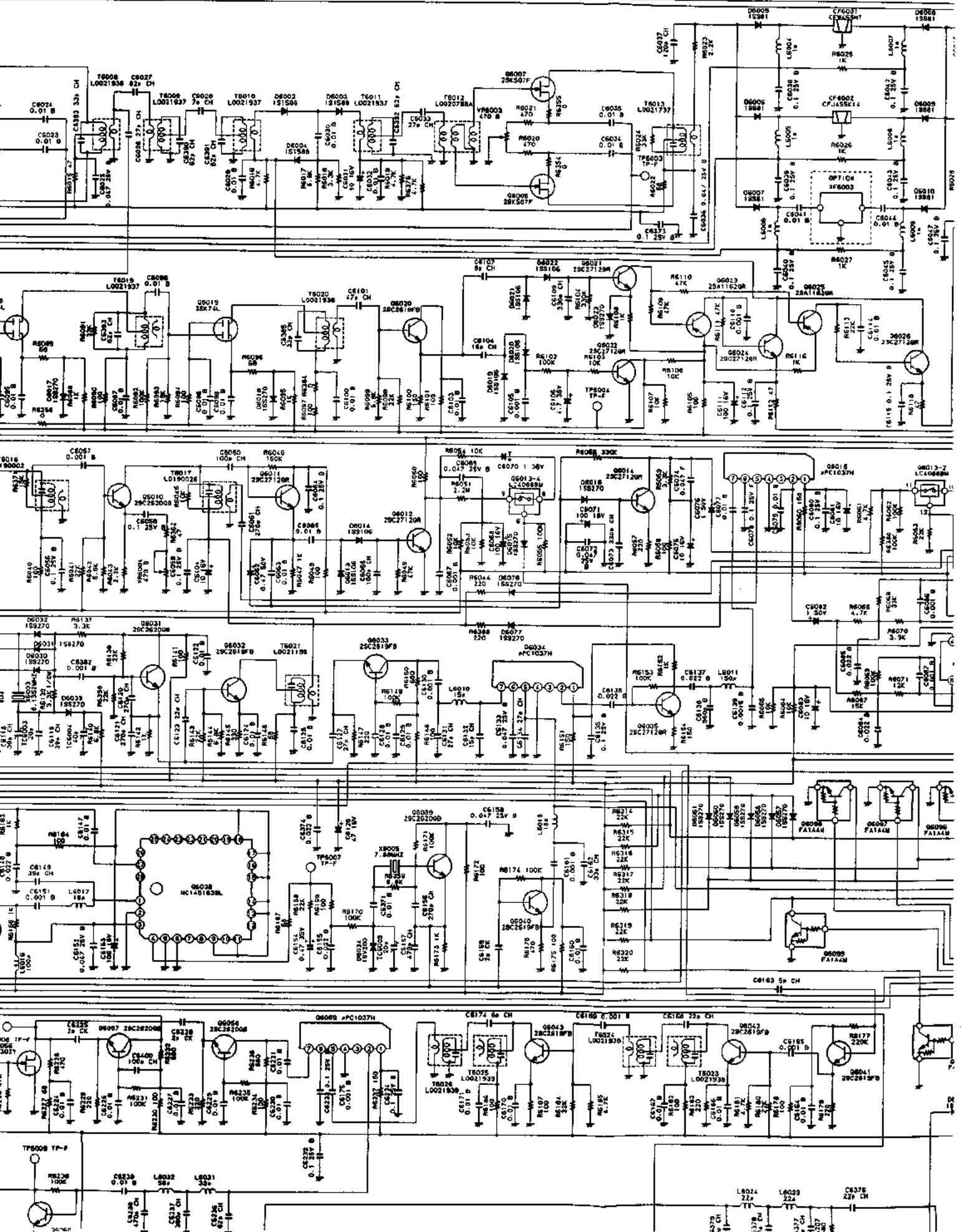

RX-2 Unit Schematic Diagram

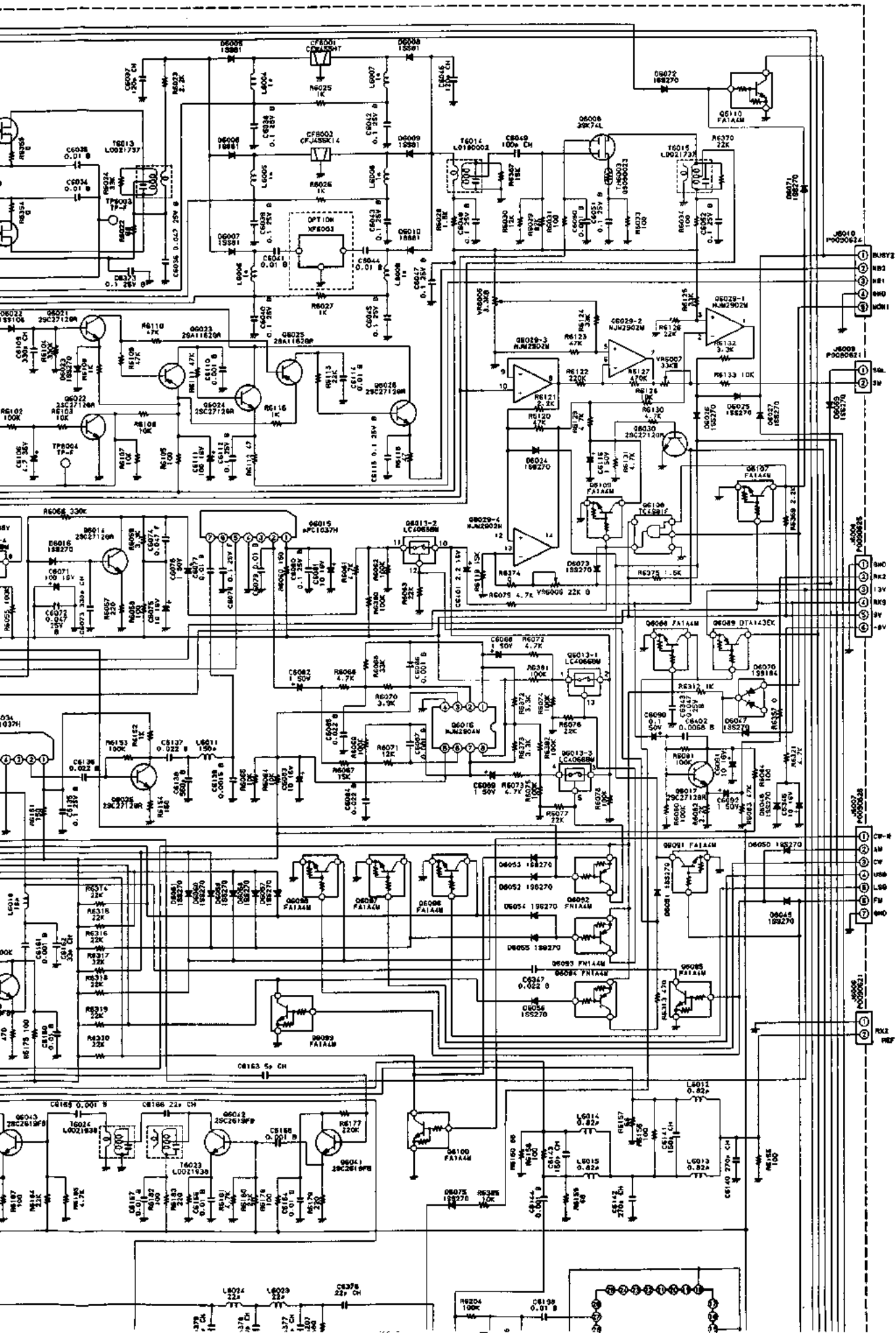

For Service Manuals Contact
MAURITRON TECHNICAL SERVICES
 8 Cherry Tree Rd, Chinnor
 Oxon OX9 4DY
 Tel: 01844-351694 Fax: 01844-352554
 Email: enquiries@mauritron.co.uk

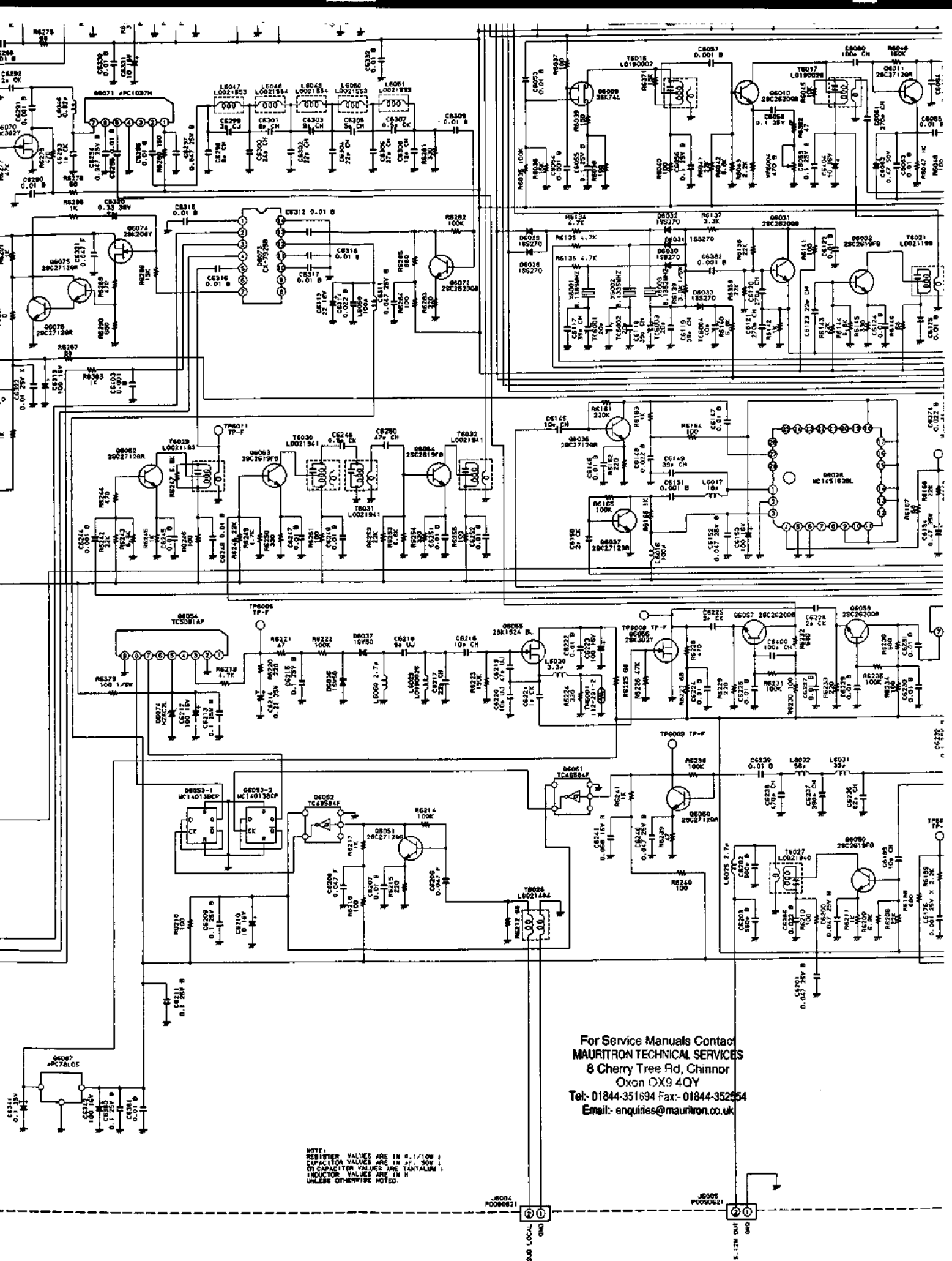

For Service Manuals Contact
MAURITRON TECHNICAL SERVICES
 8 Cherry Tree Rd, Chinnor
 Oxon OX9 4QY
 Tel: 01844-351694 Fax: 01844-352554
 Email: enquiries@mauritron.co.uk

NOTE:
 RESISTOR VALUES ARE IN Ω , k , M ;
 CAPACITOR VALUES ARE IN μ F, n F, p F;
 INDUCTOR VALUES ARE IN μ H
 UNLESS OTHERWISE NOTED.

8004
 10000021

5.0V LOCAL GND

8005
 10000021

5.12V OUT GND

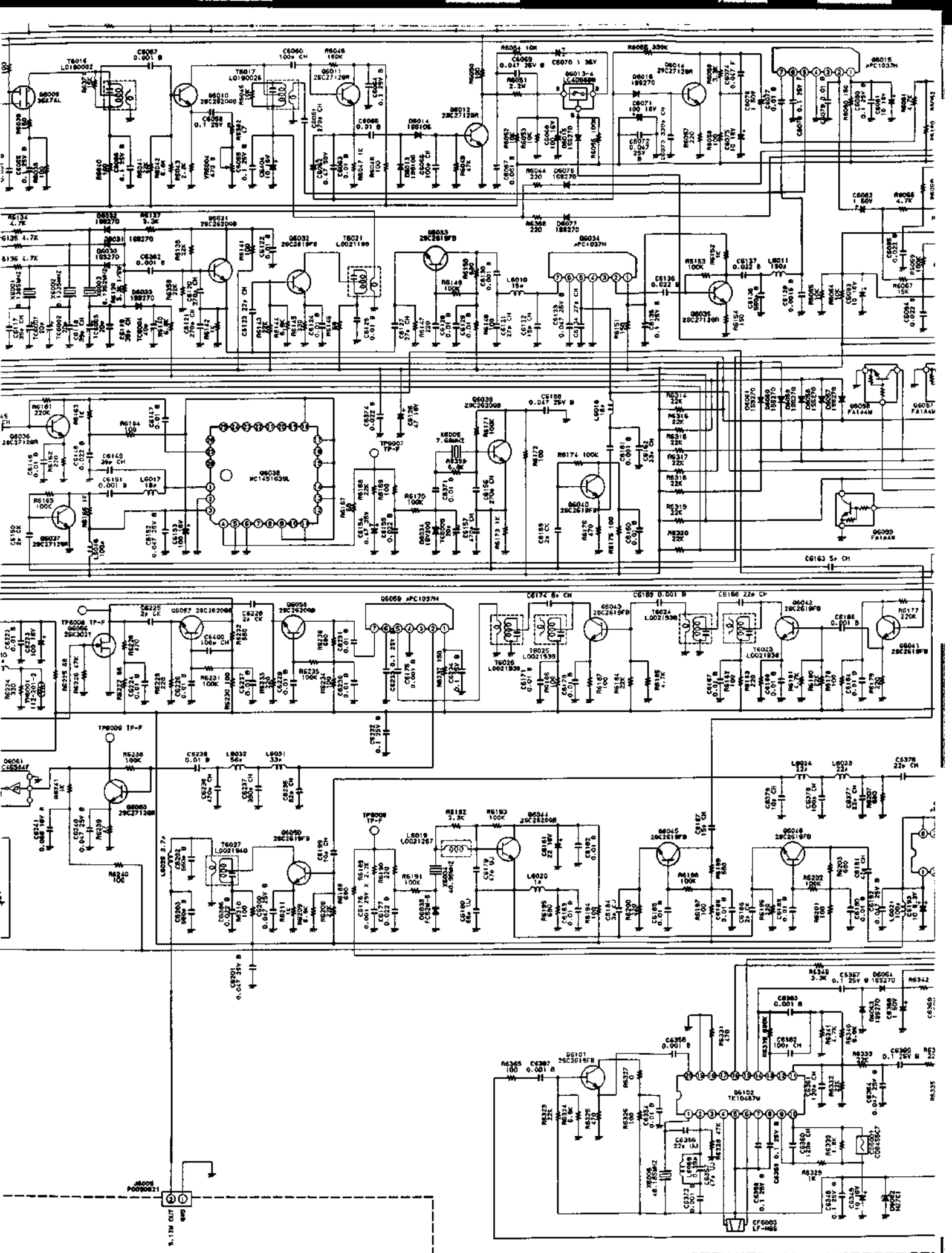

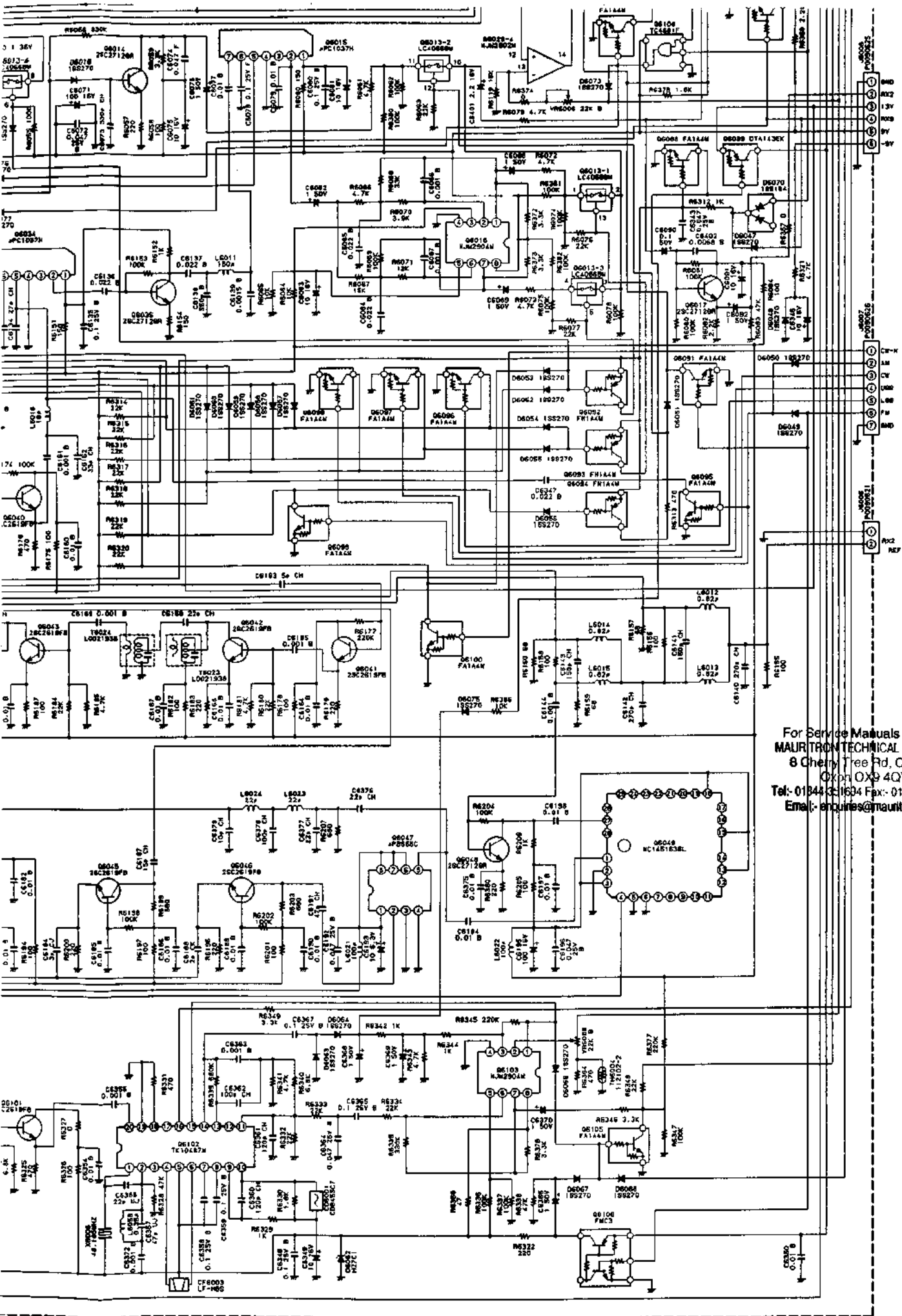

For Service Manuals Contact
MAURITRON TECHNICAL SERVICES
 8 Cherry Tree Rd, Chinnor
 Oxon OX9 4QY
 Tel: 01844 351604 Fax: 01844-352554
 Email: enquiries@mauritron.co.uk

PA Unit Parts List

ADD	CODE NO	DESCRIPTION	DEVICE	10UF	100UF	470UF	TYP VAL
** UNIT NAME : 200WPA-UNI							
C	7001	K13179009 CERAMIC CAP.	DD110F473Z50	0.047uF	50V	F	
C	7002	K13179009 CERAMIC CAP.	DD110F473Z50	0.047uF	50V	F	
C	7003	K13179009 CERAMIC CAP.	DD110F473Z50	0.047uF	50V	F	
C	7004	K13179009 CERAMIC CAP.	DD110F473Z50	0.047uF	50V	F	
C	7005	K10179038 CERAMIC CAP.	DD108B472K50	0.0047uF	50V	B	
C	7006	K13179009 CERAMIC CAP.	DD110F473Z50	0.047uF	50V	F	
C	7007	K13179009 CERAMIC CAP.	DD110F473Z50	0.047uF	50V	F	
C	7008	K13179008 CERAMIC CAP.	DD106F103Z50	0.01uF	50V	F	
C	7009	K13179009 CERAMIC CAP.	DD110F473Z50	0.047uF	50V	F	
C	7010	K13179009 CERAMIC CAP.	DD110F473Z50	0.047uF	50V	F	
C	7011	K40129004 AL. ELECTRO. CAP.	RE-16V100M	10UF	10uF	16V	
C	7012	K13179008 CERAMIC CAP.	DD106F103Z50	0.01uF	50V	F	
C	7013	K00175471 CERAMIC CAP.	DD109SL471J50	470pF	50V	SL	
C	7014	K13179009 CERAMIC CAP.	DD110F473Z50	0.047uF	50V	F	
C	7015	K13179009 CERAMIC CAP.	DD110F473Z50	0.047uF	50V	F	
C	7016	K10179038 CERAMIC CAP.	DD108B472K50	0.0047uF	50V	B	
C	7017	K10179038 CERAMIC CAP.	DD108B472K50	0.0047uF	50V	B	
C	7018	K13179008 CERAMIC CAP.	DD106F103Z50	0.01uF	50V	F	
C	7019	K13179009 CERAMIC CAP.	DD110F473Z50	0.047uF	50V	F	
C	7020	K40129004 AL. ELECTRO. CAP.	RE-16V100M	10UF	10uF	16V	
C	7021	K13179009 CERAMIC CAP.	DD110F473Z50	0.047uF	50V	F	
C	7022	K30275821 MICA CAP. LCQ18821J5	LCQ18821J5	820pF	500V		
C	7023	K10276682 CERAMIC CAP.	CD130XB682K500	0.0068uF	500V	XB	
C	7024	K10276682 CERAMIC CAP.	CD130XB682K500	0.0068uF	500V	XB	
C	7025	K13179009 CERAMIC CAP.	DD110F473Z50	0.047uF	50V	F	
C	7026	K13179009 CERAMIC CAP.	DD110F473Z50	0.047uF	50V	F	
C	7027	K13179009 CERAMIC CAP.	DD110F473Z50	0.047uF	50V	F	
C	7028	K30275681 MICA CAP. LCQ18681J5	LCQ18681J5	680pF	500V		
C	7029	K50170001 FILM CAP. ECQ-M1H104KZ	ECQ-M1H104KZ	0.1	50V		
C	7030	K50170001 FILM CAP. ECQ-M1H104KZ	ECQ-M1H104KZ	0.1	50V		
C	7031	K30279031 MICA CAP. DM15D151K5	DM15D151K5	150pF	500V		
C	7032	K30275220 MICA CAP. LCQ12220J5	LCQ12220J5	22pF	500V		
C	7033	K02175470 CERAMIC CAP.	DD106CH470J50	47pF	50V	CH	
C	7034	K13179009 CERAMIC CAP.	DD110F473Z50	0.047uF	50V	F	
C	7035	K13179009 CERAMIC CAP.	DD110F473Z50	0.047uF	50V	F	
C	7036	K40179032 AL. ELECTRO. CAP.	RE2-50V101M	100UF	100uF	50V	
C	7037	K40169026 AL. ELECTRO. CAP. RE2-35V471M	RE2-35V471M	470UF	470uF	35V	
C	7038	K13179009 CERAMIC CAP.	DD110F473Z50	0.047uF	50V	F	
C	7039	K13179009 CERAMIC CAP.	DD110F473Z50	0.047uF	50V	F	
C	7040	K13179009 CERAMIC CAP.	DD110F473Z50	0.047uF	50V	F	
C	7041	K13179008 CERAMIC CAP.	DD106F103Z50	0.01uF	50V	F	
C	7042	K13179009 CERAMIC CAP.	DD110F473Z50	0.047uF	50V	F	
C	7043	K13179009 CERAMIC CAP.	DD110F473Z50	0.047uF	50V	F	
C	7044	K40129004 AL. ELECTRO. CAP.	RE-16V100M	10UF	10uF	16V	
C	7045	K13179009 CERAMIC CAP.	DD110F473Z50	0.047uF	50V	F	
C	7046	K40129004 AL. ELECTRO. CAP.	RE-16V100M	10UF	10uF	16V	
C	7047	K13179009 CERAMIC CAP.	DD110F473Z50	0.047uF	50V	F	
C	7048	K13179009 CERAMIC CAP.	DD110F473Z50	0.047uF	50V	F	
C	7049	K13179009 CERAMIC CAP.	DD110F473Z50	0.047uF	50V	F	
C	7050	K40169026 AL. ELECTRO. CAP. RE2-35V471M	RE2-35V471M	470UF	470uF	35V	
D	7001	G2015550 DIODE	1S1555				
D	7002	G2015880 DIODE	1S1588				
D	7003	G2090002 DIODE	10D10				
D	7004	G2090002 DIODE	10D10				
D	7005	G2090002 DIODE	10D10				
D	7006	G2090002 DIODE	10D10				
J	7001	P1090255 CONNECTOR	TMP-JA				
J	7002	P1090633 CONNECTOR	JPJ2545-01-510				
J	7003	P0090712 CONNECTOR	SC25-02WL				
J	7004	S5000091 P-96	P-96				
J	7005	S5000091 P-96	P-96				
J	7006	P0090638 CONNECTOR SC25-05WL	SC25-05WL				
J	7007	P0090712 CONNECTOR	SC25-02WL				
L	7001	L1190258 M. RFC	L-C3A100KA 4EA	10uH			
L	7002	L1190248 M. RFC	L-C3A1R5MA 4DC	1.5u			
L	7003	L1020666A RFC	43T0.16 4X9CB-20				
L	7004	L1020015 RFC	FB-43-5111				
L	7005	L1020394 RFC	22T0.32 4X10^ -7				
L	7006	L1020394 RFC	22T0.32 4X10^ -7				
L	7007	L1020015 RFC	FB-43-5111				
L	7008	L0021432 COIL	41.000 3A FR9.5-5				
L	7009	L1020728 RFC	3A R15.8X6.4-2				
L	7010	L1020728 RFC	3A R15.8X6.4-2				
L	7011	L1020666A RFC	43T0.16 4X9CB-20				
Q	7001	G3321660 TRANSISTOR	2SC2166				
Q	7002	G3090092 TRANSISTOR	MRF486				
Q	7003	G3090092 TRANSISTOR	MRF486				
Q	7004	G3090059 TRANSISTOR	MRF422				
Q	7005	G3090059 TRANSISTOR	MRF422				
Q	7006	G3408820Q TRANSISTOR	2SD882Q				

PA Unit Parts List

ADD	CODE NO	DESCRIPTION	DEVICE			TYP VAL
Q 7007	G3408820Q	TRANSISTOR	2SD882Q			
Q 7008	G1090946	IC	MC7808CT			
Q 7009	G3112830D	TRANSISTOR	2SA1283D			
Q 7010	G3090079	TRANSISTOR	BA1A4P			
R 7001	J20336680	METAL FILM RES.	RS2B 2W K 68	68		2W
R 7002	J02225331	CARBON FILM RES.	RD16UJ331	330	330	1/6W
R 7003	J02225680	CARBON FILM RES.	RD16UJ680	68	68	1/6W
R 7004	J01275229	CARBON FILM RES.	RD12TJ2R2	2.2	2.2	1/2W
R 7005	J02225471	CARBON FILM RES.	RD16UJ471	470	470	1/6W
R 7006	J01275159	CARBON FILM RES.	RD12TJ1R5	1.5	1.5	1/2W
R 7007	J01275159	CARBON FILM RES.	RD12TJ1R5	1.5	1.5	1/2W
R 7008	J01275180	CARBON FILM RES.	RD12TJ180	18	18	1/2W
R 7009	J01275180	CARBON FILM RES.	RD12TJ180	18	18	1/2W
R 7010	J20306221	METAL FILM RES.	RS1B 1W K 220		220	1W
R 7011	J20306221	METAL FILM RES.	RS1B 1W K 220		220	1W
R 7012	J01225271	CARBON FILM RES.	RD16PJ271	270	270	1/6W
R 7013	J20336680	METAL FILM RES.	RS2B 2W K 68		68	2W
R 7014	J20336049	METAL FILM RES.	RS2B 2W K 0.4		5	2W
R 7015	J20306339	METAL FILM RES.	RS1B 1W K 3.3		3.3	1W
R 7016	J20306339	METAL FILM RES.	RS1B 1W K 3.3		3.3	1W
R 7017	J20306339	METAL FILM RES.	RS1B 1W K 3.3		3.3	1W
R 7018	J20306339	METAL FILM RES.	RS1B 1W K 3.3		3.3	1W
R 7019	J20306100	METAL FILM RES.	RS1B 1W K 10		10	1W
R 7020	J20306100	METAL FILM RES.	RS1B 1W K 10		10	1W
R 7021	J22335479	METAL FILM RES.	ERX-2SJ4R7		4.7	2W
R 7022	J22335479	METAL FILM RES.	ERX-2SJ4R7		4.7	2W
R 7023	J22335479	METAL FILM RES.	ERX-2SJ4R7		4.7	2W
R 7024	J22335479	METAL FILM RES.	ERX-2SJ4R7		4.7	2W
R 7025	J01225151	CARBON FILM RES.	RD16PJ151	150	150	1/6W
R 7026	J02225680	CARBON FILM RES.	RD16UJ680	68	68	1/6W
R 7027	J32009004	SHUNT RES. R025 J 0.025OHM	R025 J		0.025	
R 7028	J02245103	CARBON FILM RES.	RD14SJ103	10K	10K	1/4W
R 7029	J02245562	CARBON FILM RES.	RD14SJ562	5.6K	5.6K	1/4W
R 7030	J02245562	CARBON FILM RES.	RD14SJ562	5.6K	5.6K	1/4W
R 7031	J02245102	CARBON FILM RES.	RD14SJ102	1K	1K	1/4W
R 7032	J02225103	CARBON FILM RES.	RD16UJ103	10K	10K	1/6W
R 7033	J02225102	CARBON FILM RES.	RD16UJ102	1K	1K	1/6W
T 7001	L0021351	COIL	4-1 2001F FR6			
T 7002	L0021969	COIL	- 3A6 RIB3X7			
T 7003	L0021970	COIL	D12A RIB10X			
T 7004	L0021615B	COIL	D12A TR16			
T 7005	L0021971	COIL	D12A RIB21X			
TP7001	Q5000011	WRAPPING TERMINAL	C			
TP7002	Q5000011	WRAPPING TERMINAL	C			
TP7003	Q5000011	WRAPPING TERMINAL	C			
TP7004	Q5000011	WRAPPING TERMINAL	C			
TP7005	Q5000011	WRAPPING TERMINAL	C			
TP7006	Q5000011	WRAPPING TERMINAL	C			
TS7001	N7090025	THERMAL SWITCH OHD-60M	OHD-60M			
VR7001	J50709471	POT.	H1052A	-470B	470B	
VR7002	J50709471	POT.	H1052A	-470B	470B	

For Service Manuals Contact
MAURITRON TECHNICAL SERVICES
 8 Cherry Tree Rd, Chinnor
 Oxon OX9 4QY
 Tel:- 01844-351694 Fax:- 01844-352554
 Email:- enquiries@mauritron.co.uk

For Service Manuals Contact
MAURITRON TECHNICAL SERVICES
8 Cherry Tree Rd, Chinnor
Oxon OX9 4QY
Tel: 01844-351694 Fax: 01844-352554
Email: enquiries@maurtron.co.uk

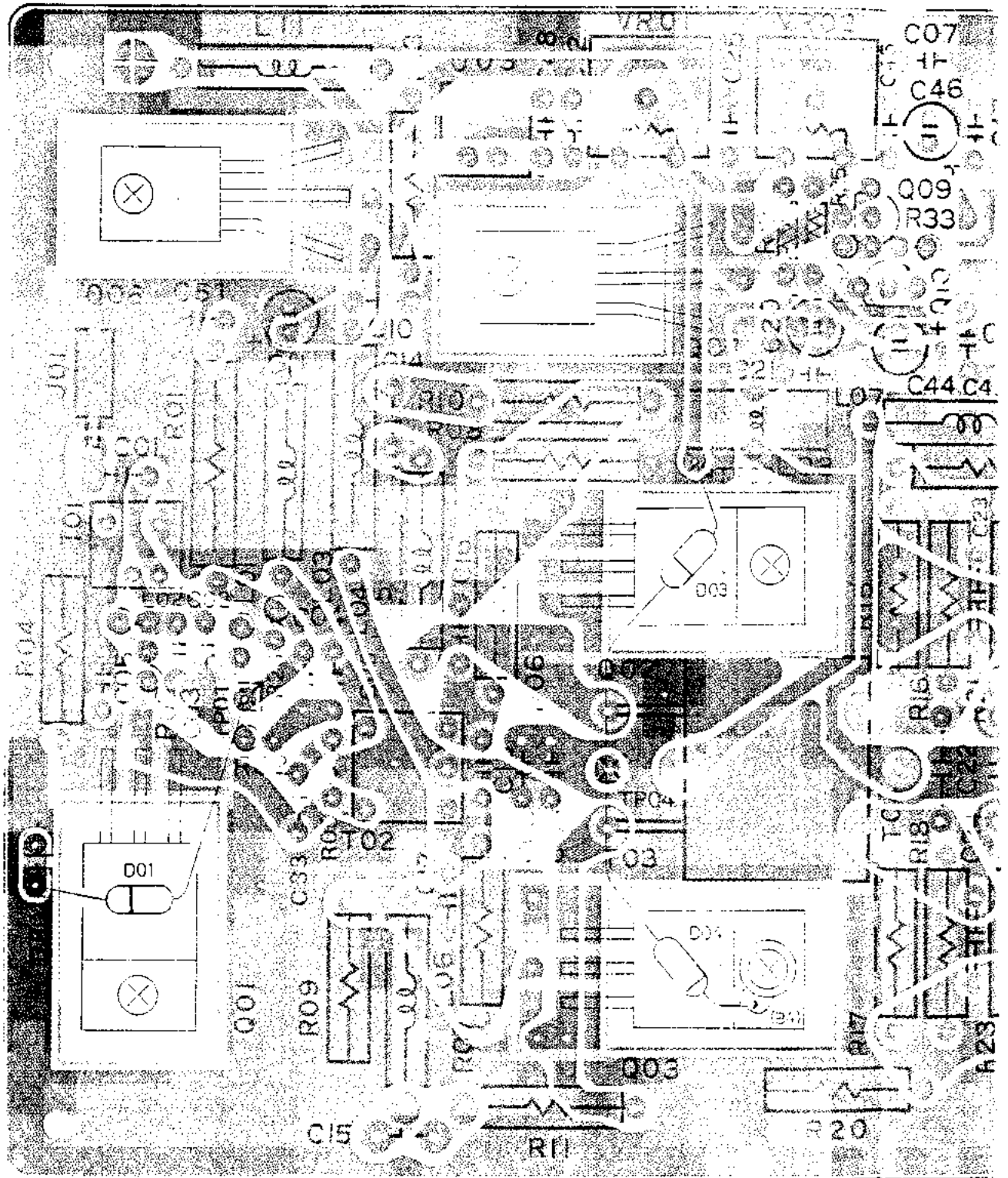

For Service Manuals Contact
MAURITRON TECHNICAL SERVICES
8 Cherry Tree Rd, Chinnor
Oxon OX9 4QY
Tel: 01844-351694 Fax: 01844-352554
Email: enquiries@mauritron.co.uk

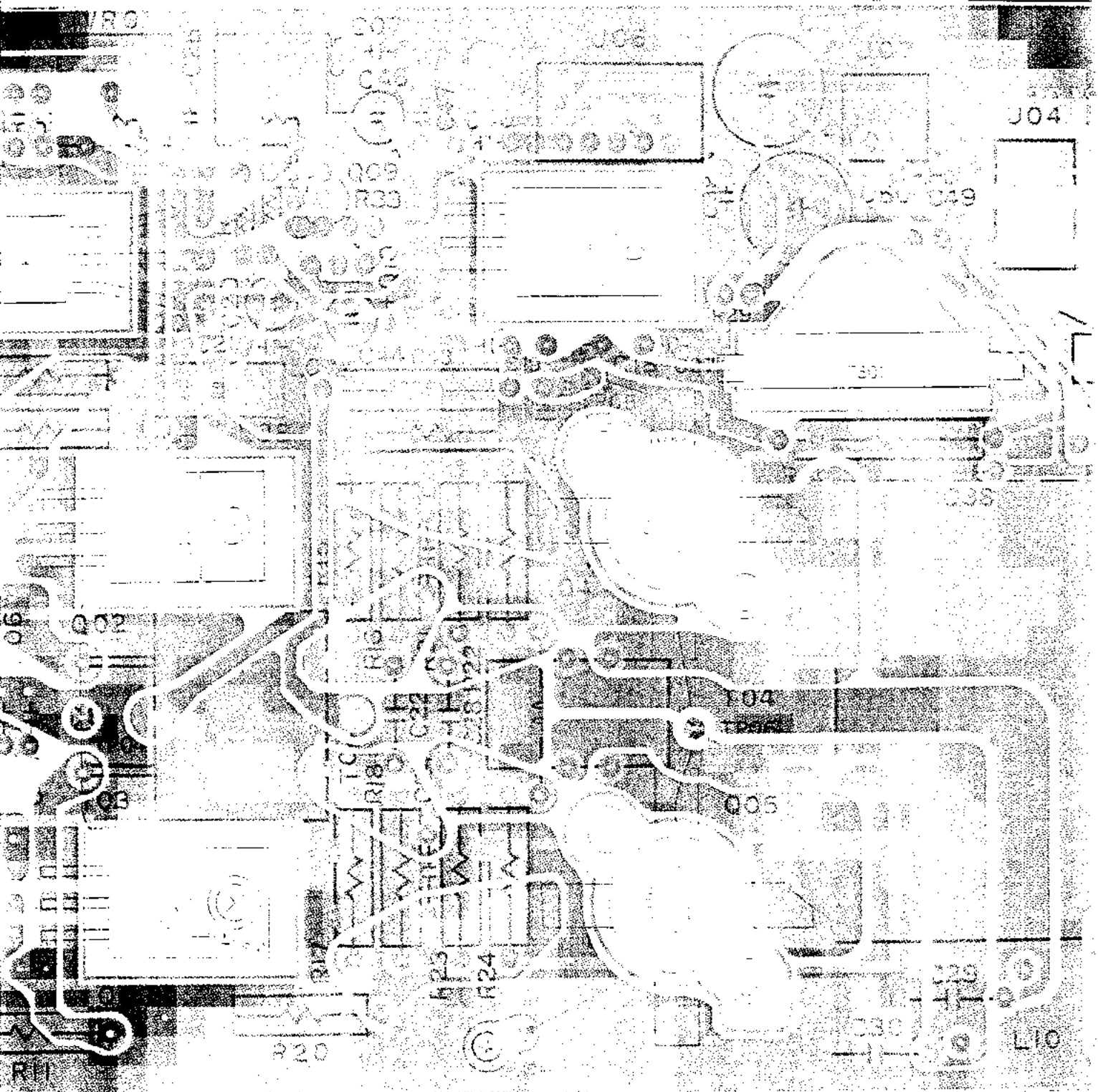

(obverse)

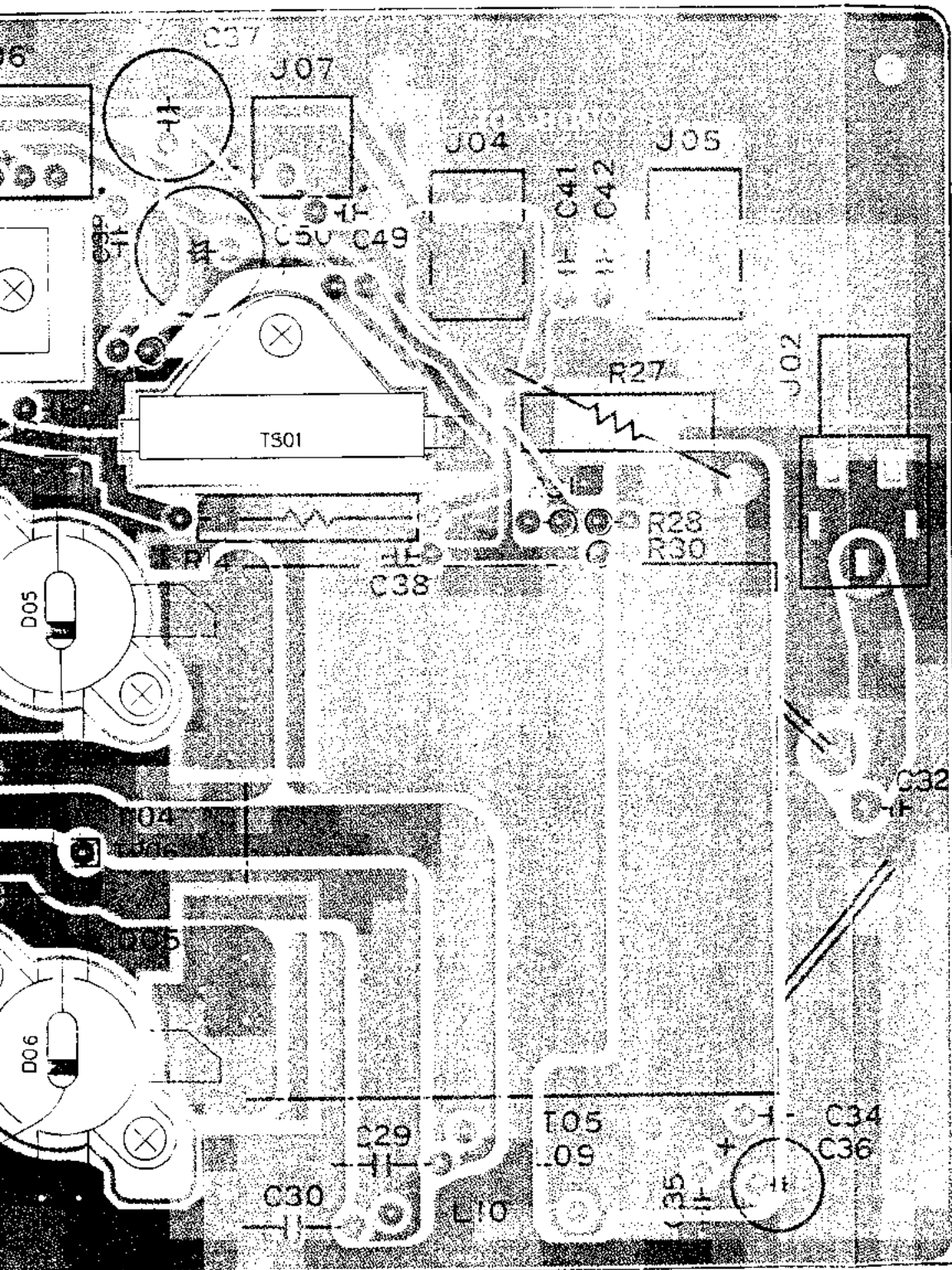

(obverse view of "component" side)

PA Unit Board Layout

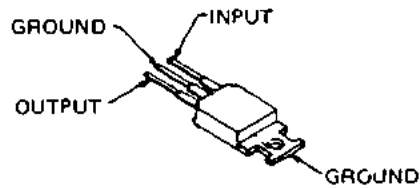
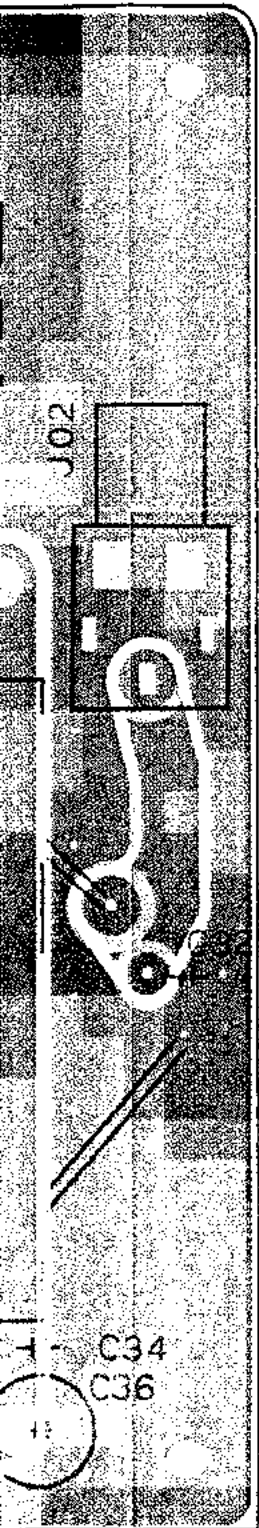

MC7808CT
(Q7008)

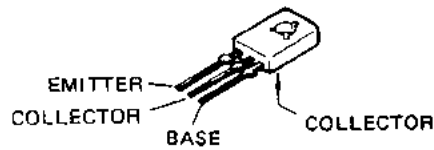

2SD8820
(Q7006, Q7007)

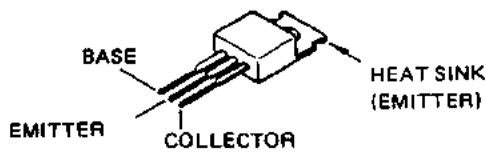

2SC2166
(Q7001)
MRF486
(Q7002, Q7003)

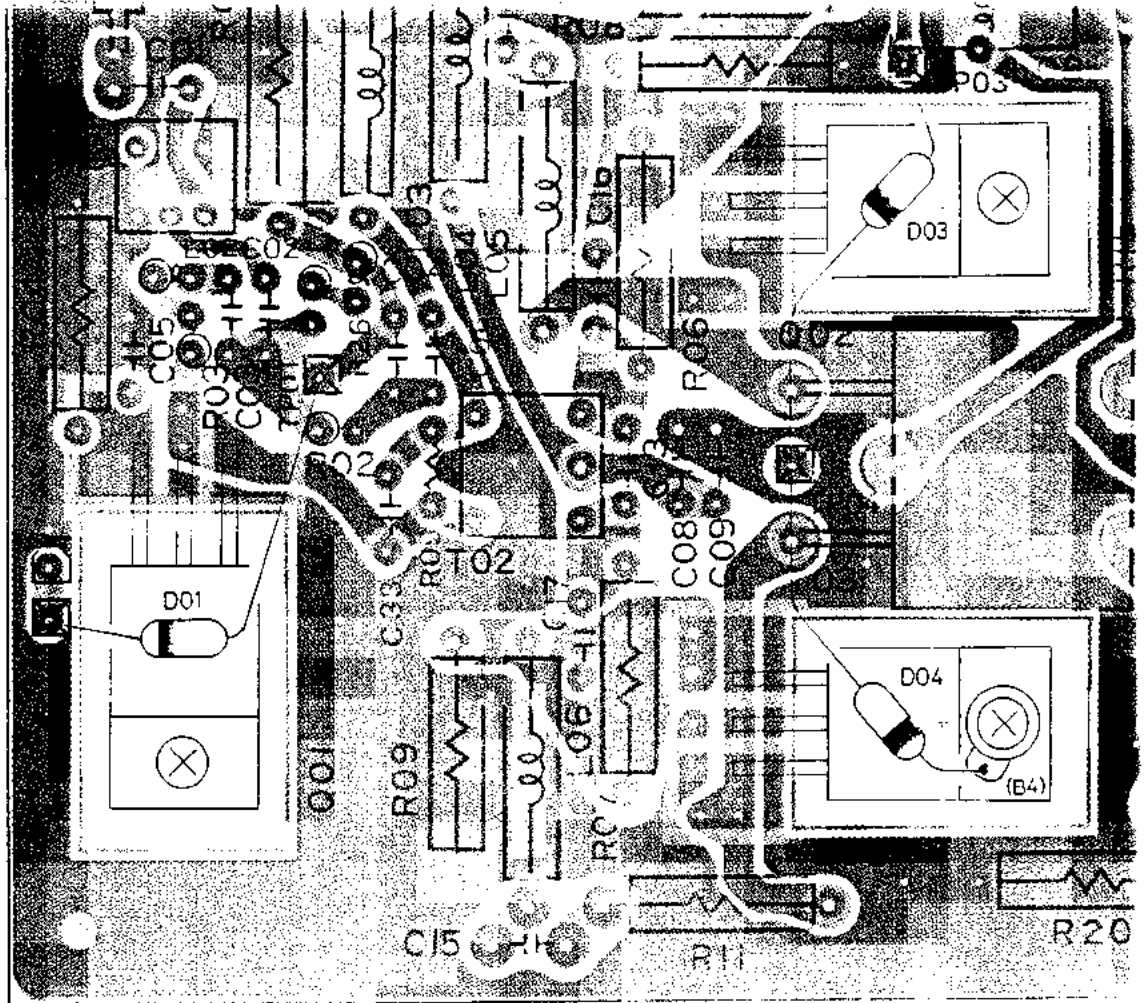

For Service Manuals Contact
MAURITRON TECHNICAL SERVICES
 8 Cherry Tree Rd, Chinnor
 Oxon OX9 4QY
 Tel: 01844-351694 Fax: 01844-352554
 Email: enquiries@mauritron.co.uk

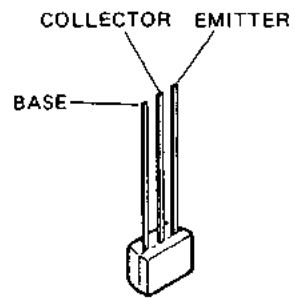

BA1A4P
 (07010)

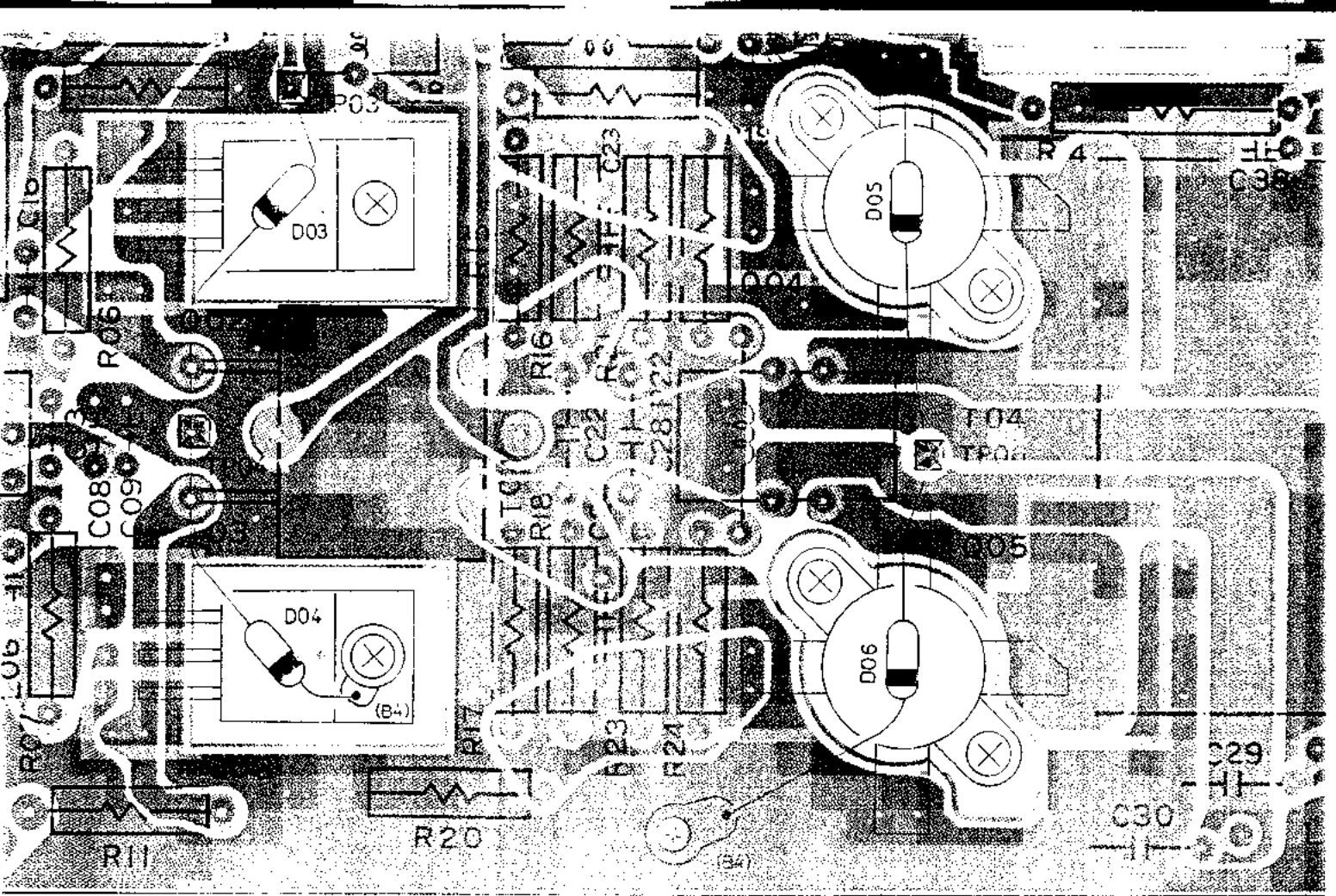

(o

For Service Manuals Contact
MAURITRON TECHNICAL SERVICES
 8 Cherry Tree Rd, Chinnor
 Oxon OX9 4QY
 Tel: 01844-351694 Fax: 01844-352554
 Email: enquiries@mauritron.co.uk

COLLECTOR EMITTER

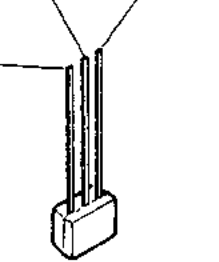

BA1A4P
(Q7010)

COLLECTOR
 BASE EMITTER

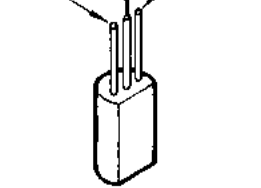

2SA1283D
(Q7009)

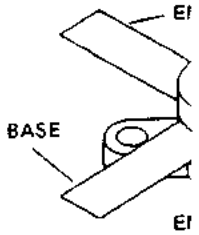

MF
(

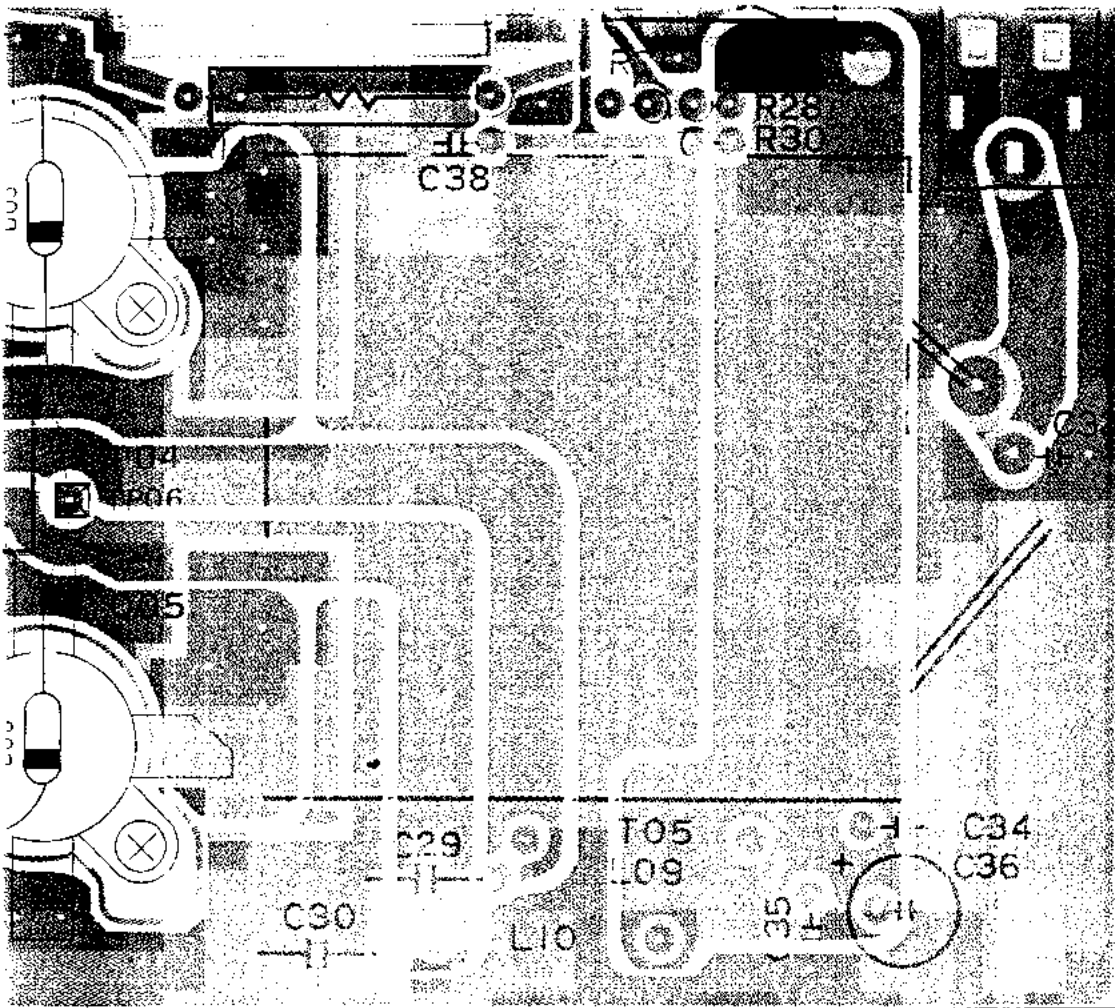

(obverse view of "component" side)

EMIT

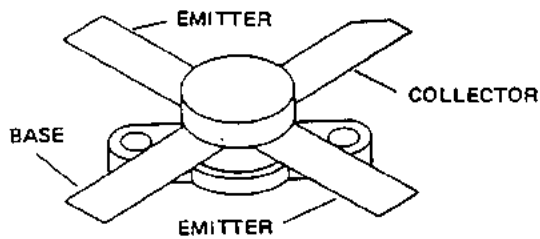

MRF422
 (Q7004, Q7005)



ponent" side)

OR

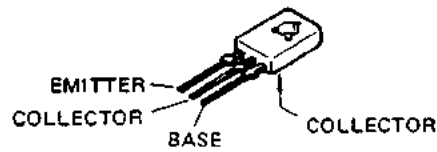

2SD8820
(07006, 07007)

For Service Manuals Contact
MAURITRON TECHNICAL SERVICES
 8 Cherry Tree Rd, Chinnor
 Oxon OX9 4QY
 Tel: 01844-351694 Fax: 01844-352554
 Email: enquiries@mauritron.co.uk

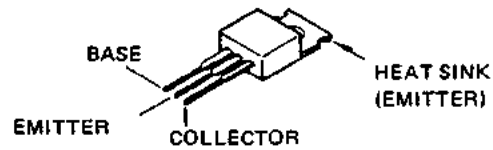

2SC2166
(07001)
 MRF486
(07002, 07003)

For Service Manuals Contact
MAURITRON TECHNICAL SERVICES
8 Cherry Tree Rd, Chinnor
Oxon OX9 4QY
Tel: 01844-351694 Fax: 01844-352564
Email: enquiries@maurtron.co.uk

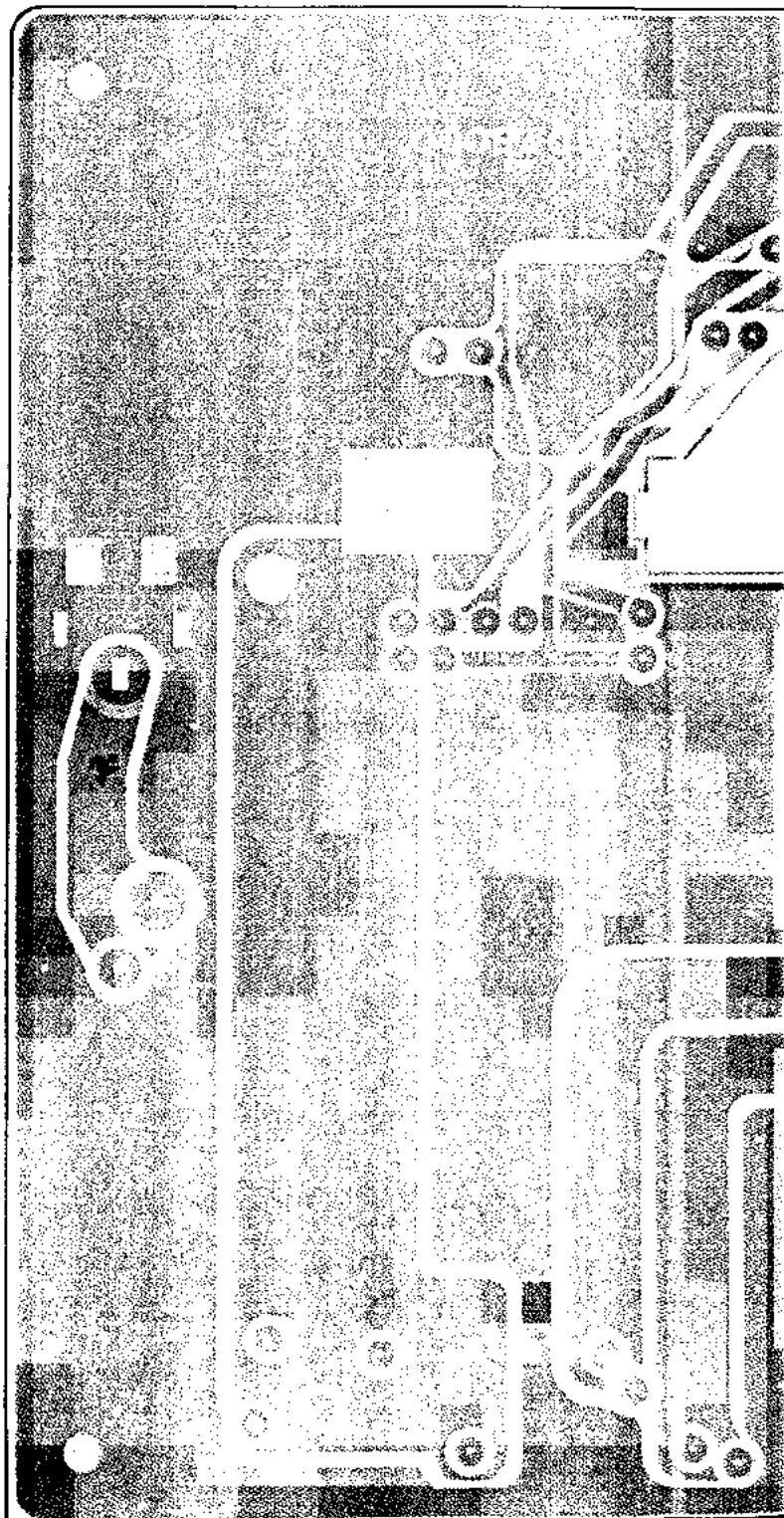

For Service Manuals Contact
MAURITRON TECHNICAL SERVICES
8 Cherry Tree Rd, Chinnor
Oxon OX9 4QY
Tel: 01844-351694 Fax: 01844-352554
Email: enquiries@mauritron.co.uk

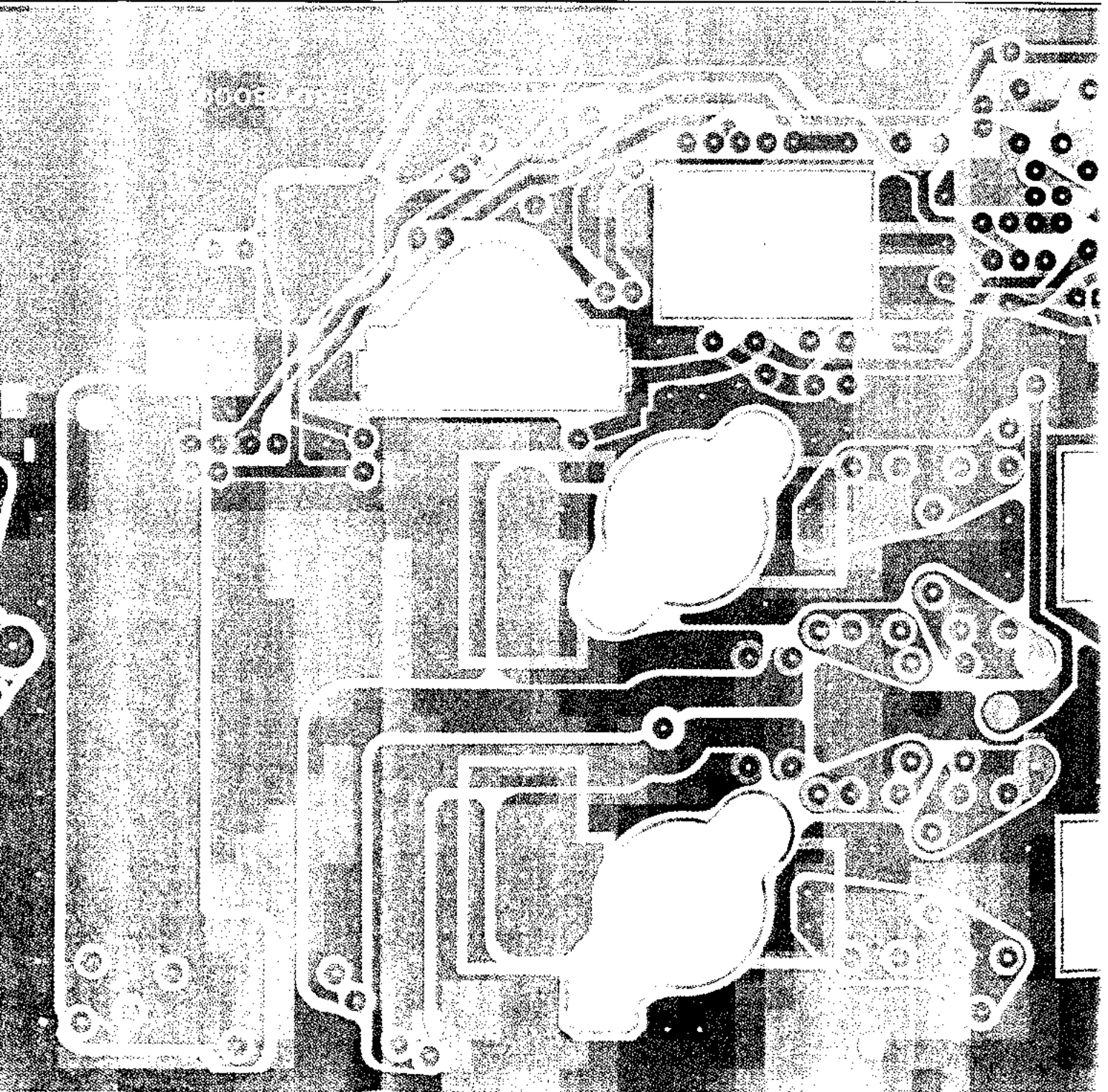

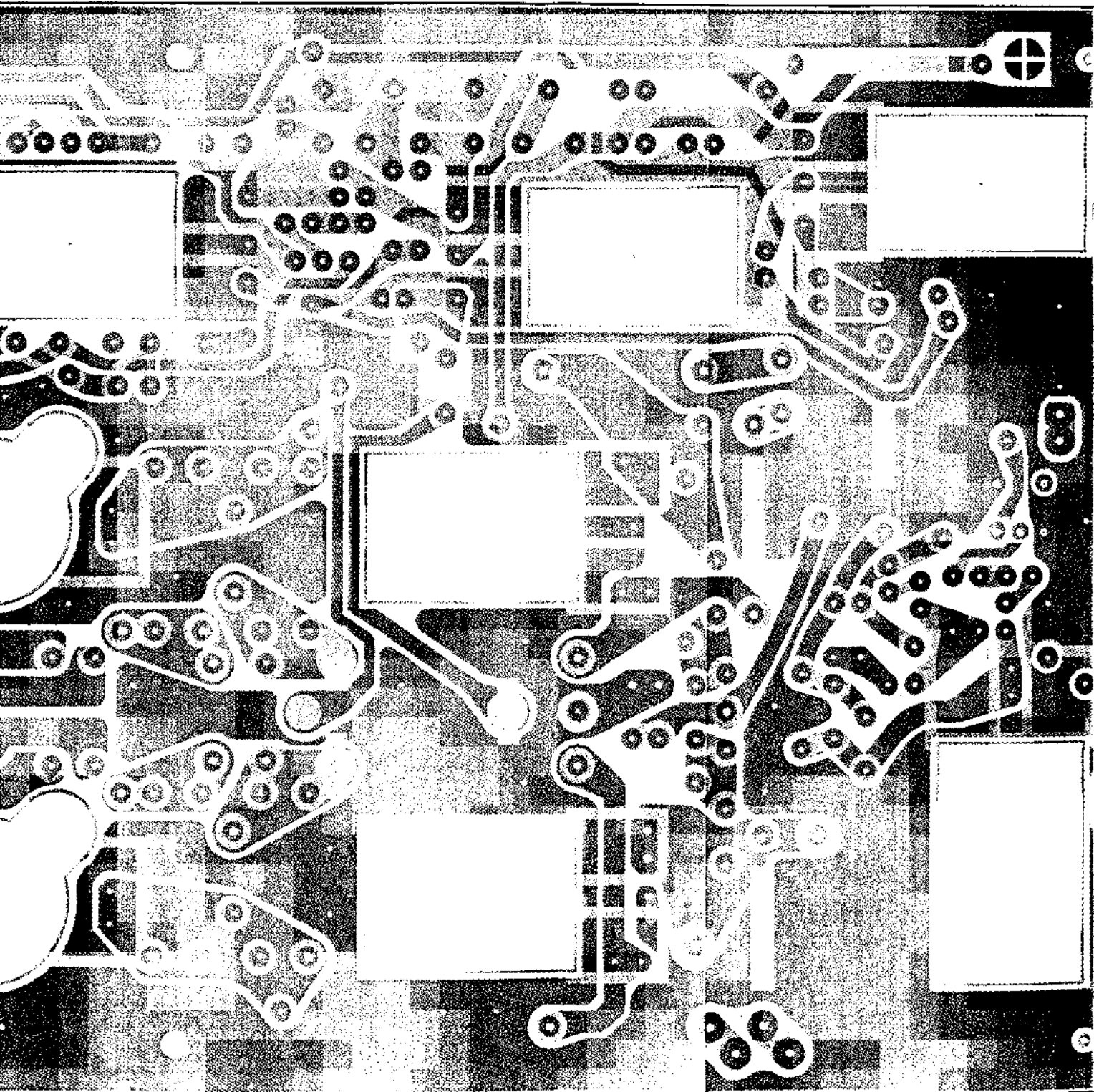

PA Unit Board Layout

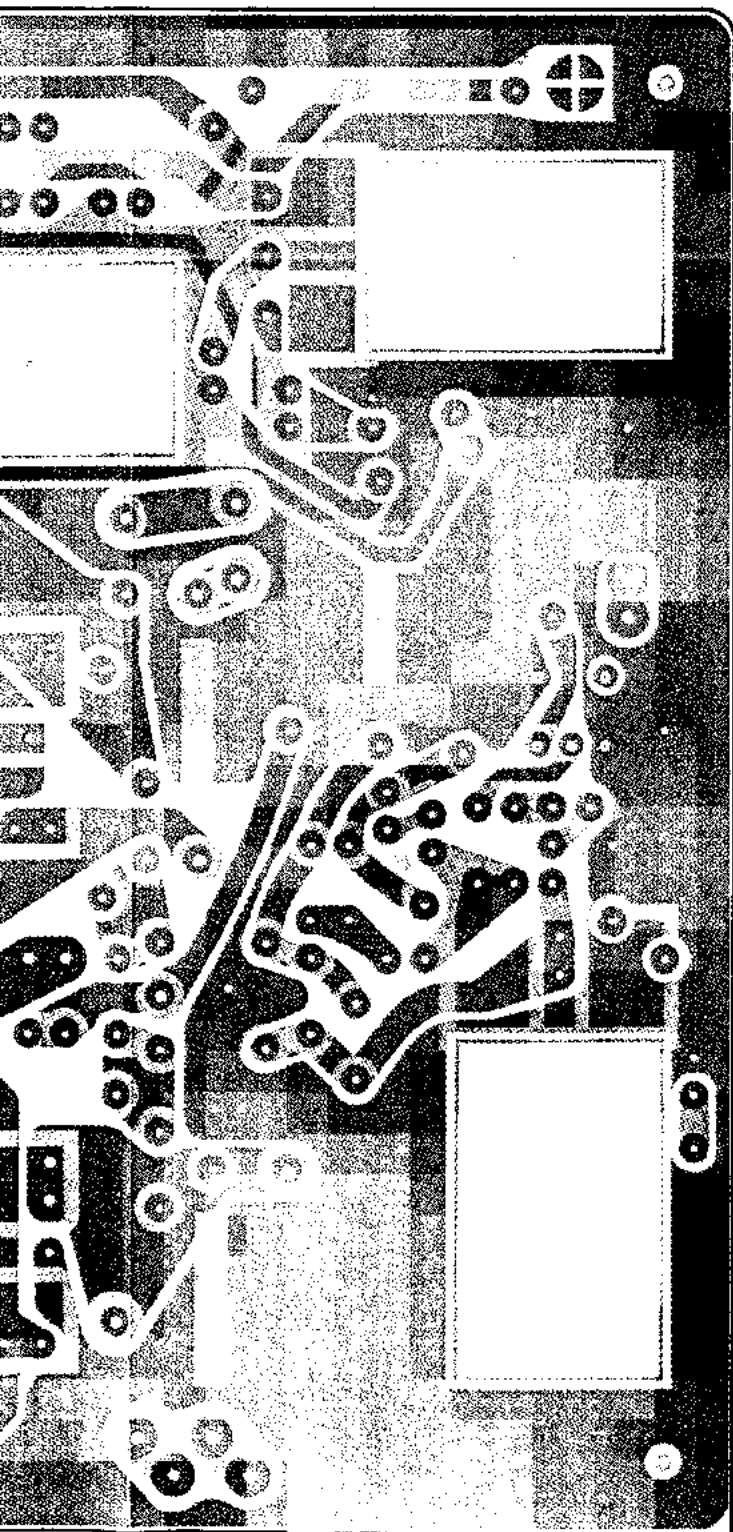

For Service Manuals Contact
MAURITRON TECHNICAL SERVICES
8 Cherry Tree Rd, Chinnor
Oxon OX9 4QY
Tel: 01844-351694 Fax: 01844-352554
Email: enquiries@maurifron.co.uk

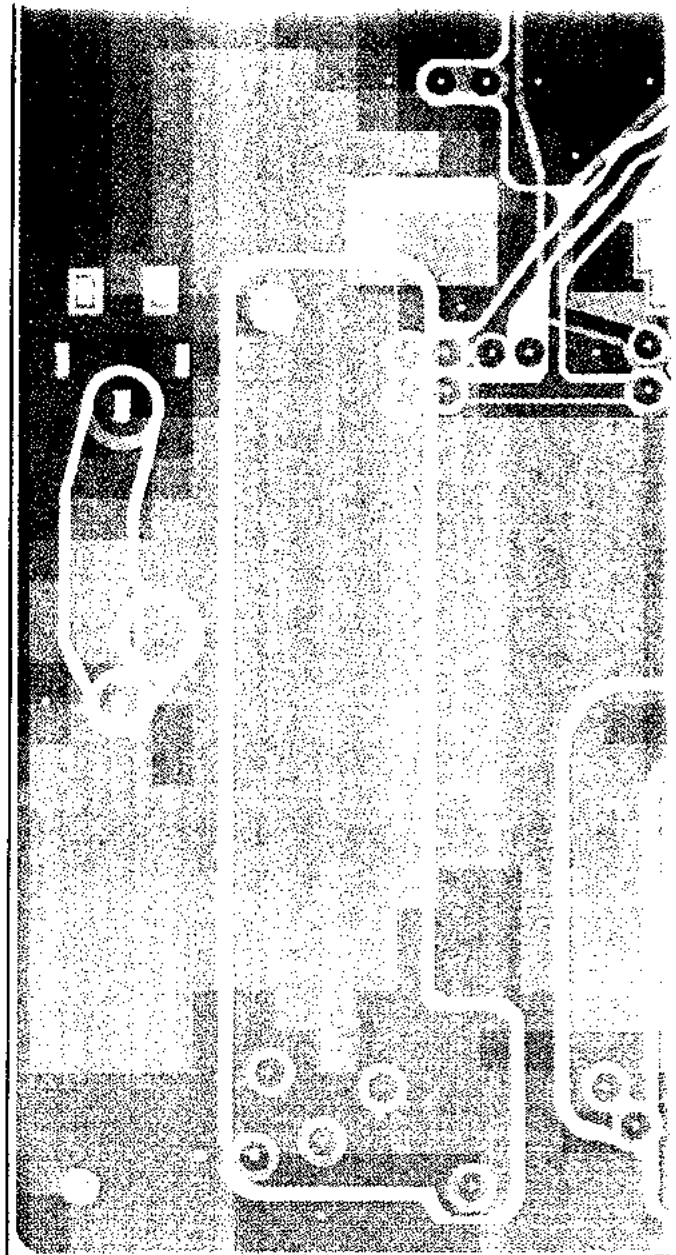

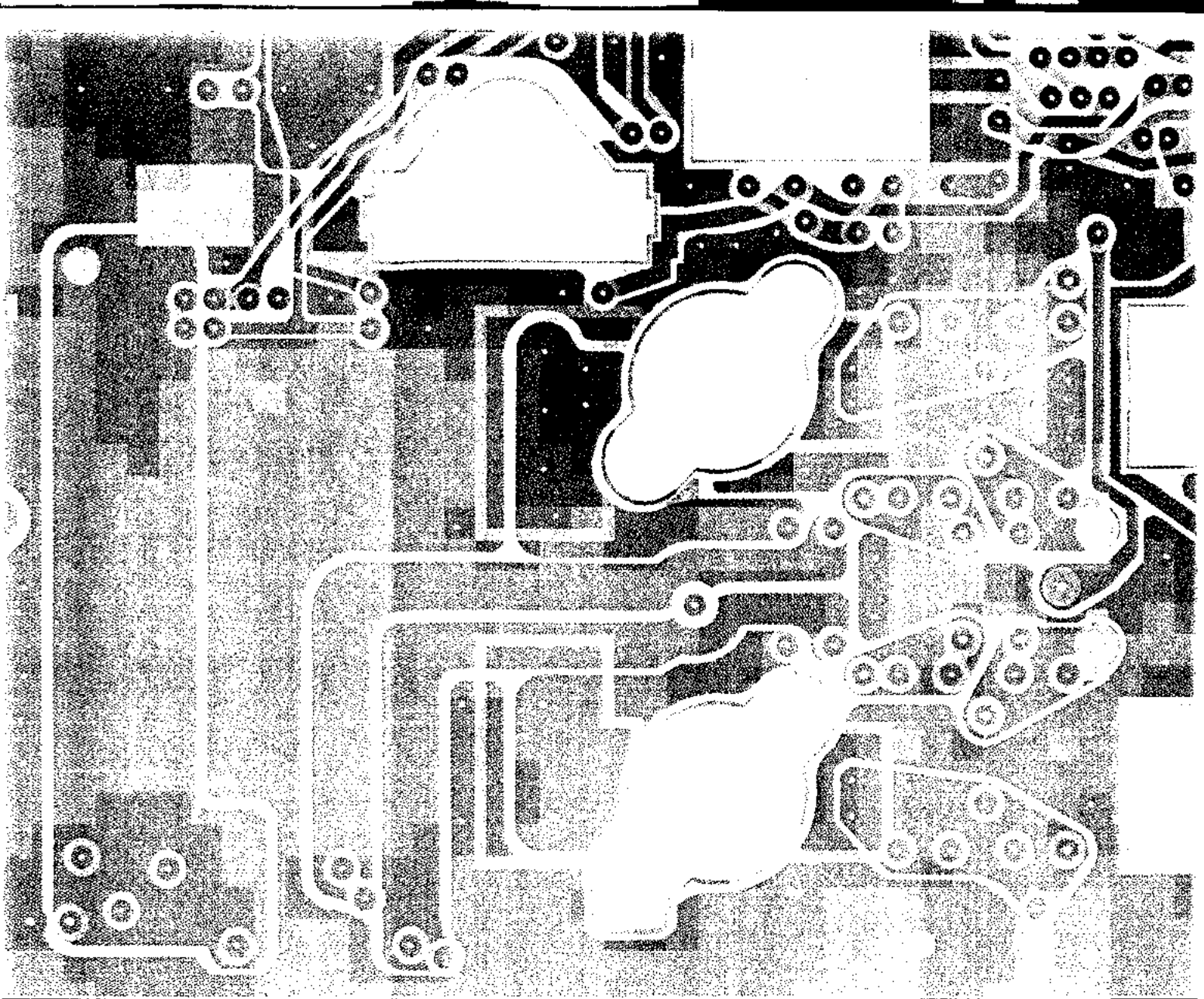

For Service Manuals Contact
MAURITRON TECHNICAL SERVICES
8 Cherry Tree Rd, Chinnor
Oxon OX9 4QY
Tel:- 01844-351034 Fax:- 01844-352554
Email:- enquiries@mauriton.co.uk

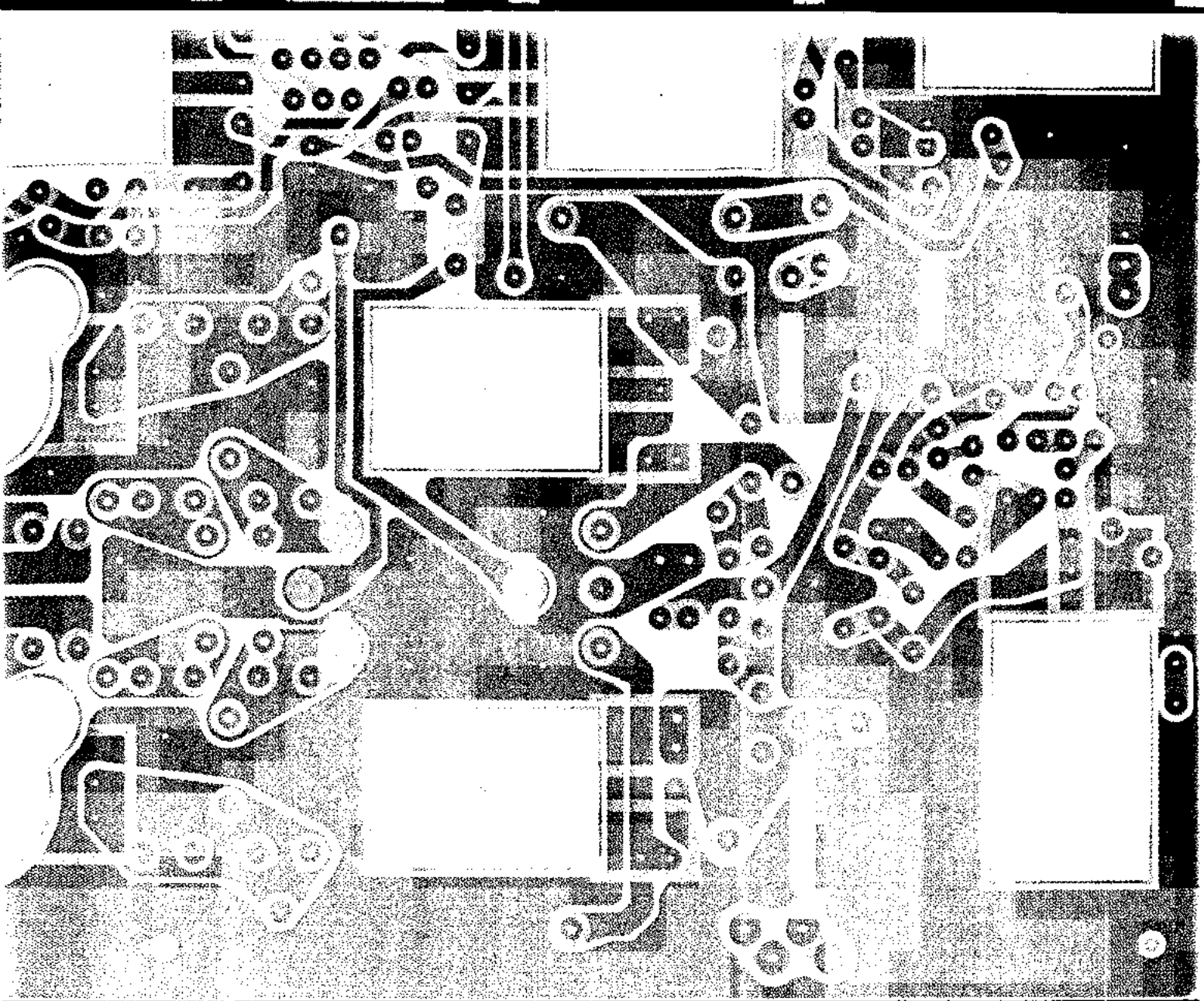

(obverse view of "solder" side)

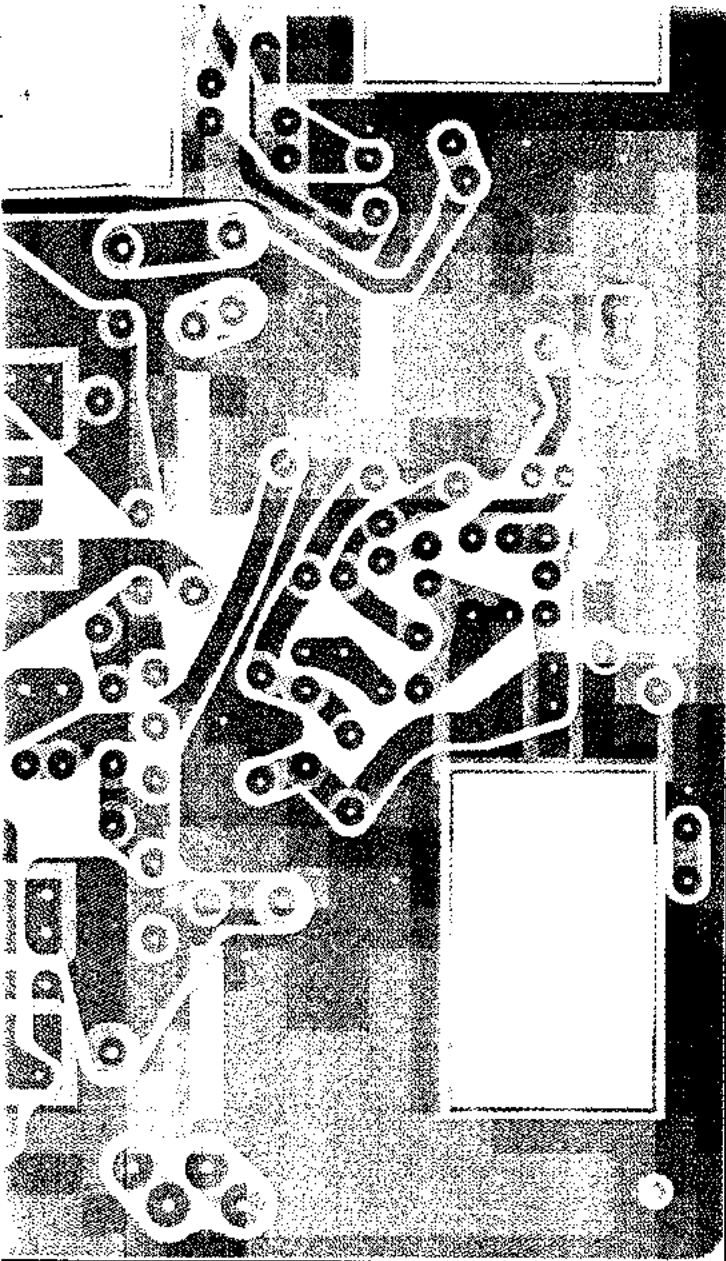

(obverse view of "solder" side)

For Service Manuals Contact
MAURITRON TECHNICAL SERVICES
8 Cherry Tree Rd, Chinnor
Oxon OX9 4QY
Tel: 01844-351694 Fax: 01844-352554
Email: enquiries@mauritron.co.uk

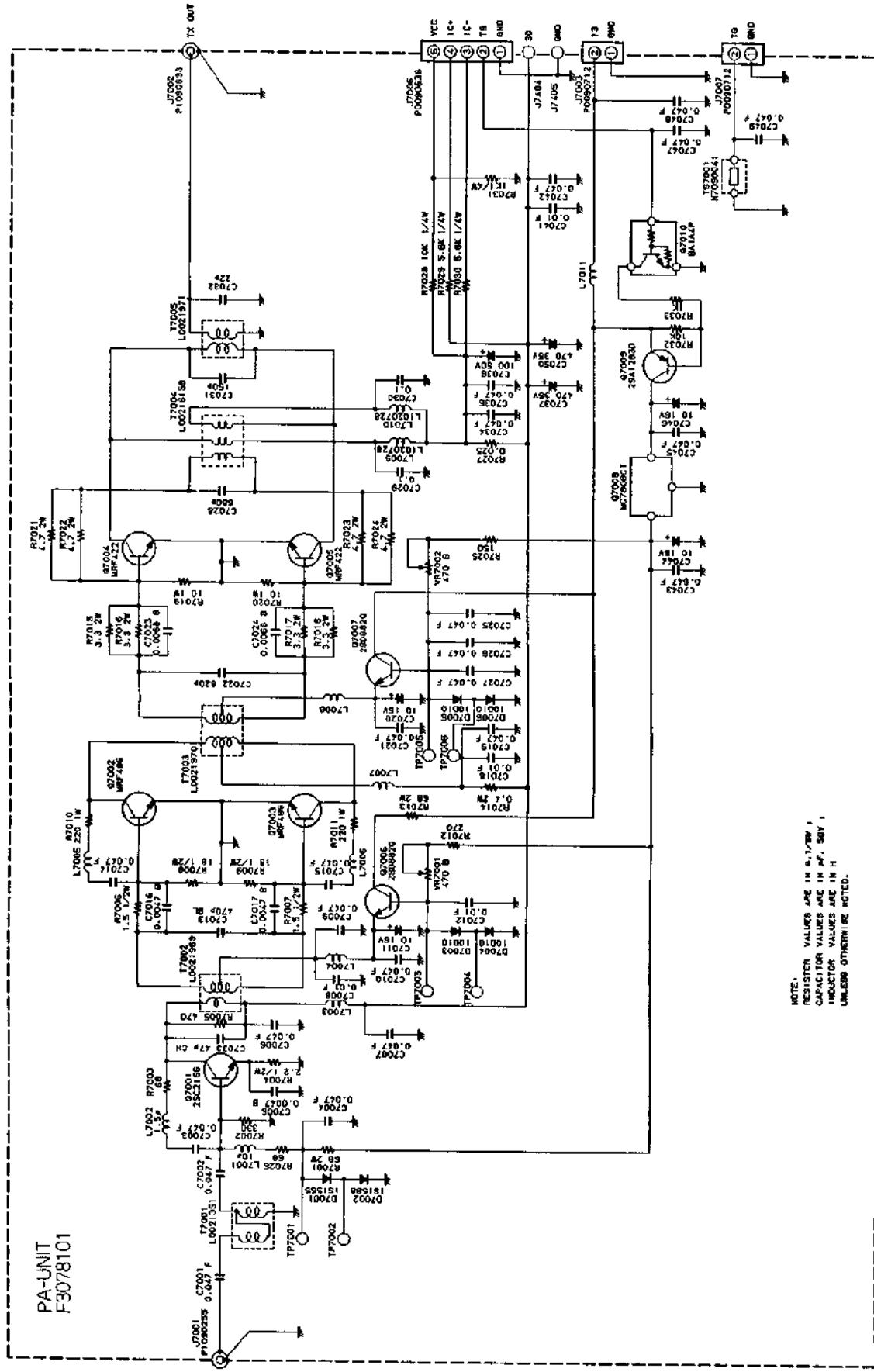

NOTE:
RESISTOR VALUES ARE IN OHMS,
CAPACITOR VALUES ARE IN MICROSECONDS,
INDUCTOR VALUES ARE IN HENRYS,
UNLESS OTHERWISE NOTED.

LPF Unit Parts List

ADD	CODE NO	DESCRIPTION	DEVICE	TYP	VAL
** UNIT NAME : LPF-UNIT					
C 7201	K30275102	MICA CAP.	LCQ21102J5	0.001	500V
C 7202	K30275331	MICA CAP.	LCQ17331J5	330pF	500V
C 7203	K30275561	MICA CAP.	LCQ18561J5	560pF	500V
C 7204	K30279098	MICA CAP.	DM19D222J5	0.0022	500V
C 7205	K30275301	MICA CAP.	LCQ17301J5	300p	500V
C 7206	K30275161	MICA CAP.	LCQ17161J5	160p	500V
C 7207	K30275102	MICA CAP.	LCQ21102J5	0.001	500V
C 7208	K30275561	MICA CAP.	LCQ18561J5	560pF	500V
C 7209	K30275471	MICA CAP.	LCQ17471J5	470pF	500V
C 7210	K30275271	MICA CAP.	LCQ17271J5	270pF	500V
C 7211	K30275361	MICA CAP.	LCQ17361J5	360p	500V
C 7212	K30275102	MICA CAP.	LCQ21102J5	0.001	500V
C 7213	K30275561	MICA CAP.	LCQ18561J5	560pF	500V
C 7214	K30275151	MICA CAP.	LCQ17151J5	150pF	500V
C 7215	K30275911	MICA CAP.	LCQ21911J5	910p	500V
C 7216	K30275621	MICA CAP.	LCQ18621J5	620p	500V
C 7217	K30275301	MICA CAP.	LCQ17301J5	300p	500V
C 7218	K30275751	MICA CAP.	LCQ18751J5	750p	500V
C 7219	K30275471	MICA CAP.	LCQ17471J5	470pF	500V
C 7220	K30275121	MICA CAP.	LCQ17121J5	120pF	500V
C 7221	K30275751	MICA CAP.	LCQ18751J5	750p	500V
C 7222	K30275361	MICA CAP.	LCQ17361J5	360p	500V
C 7223	K30275201	MICA CAP.	LCQ17201J5	200p	500V
C 7224	K30275361	MICA CAP.	LCQ17361J5	360p	500V
C 7225	K30275391	MICA CAP.	LCQ17391J5	390pF	500V
C 7226	K30275510	MICA CAP.	LCQ12510J5	51p	500V
C 7227	K30275431	MICA CAP.	LCQ18431J5	430p	500V
C 7228	K30275221	MICA CAP.	LCQ17221J5	220pF	500V
C 7229	K30275101	MICA CAP.	LCQ12101J5	100pF	500V
C 7230	K30275301	MICA CAP.	LCQ17301J5	300p	500V
C 7231	K30275301	MICA CAP.	LCQ17301J5	300p	500V
C 7232	K30275360	MICA CAP.	LCQ12360J5	36p	500V
C 7233	K30275221	MICA CAP.	LCQ17221J5	220pF	500V
C 7234	K30275151	MICA CAP.	LCQ17151J5	150pF	500V
C 7235	K30275560	MICA CAP.	LCQ12560J5	56pF	500V
C 7236	K30275201	MICA CAP.	LCQ17201J5	200p	500V
C 7237	K30275201	MICA CAP.	LCQ17201J5	200p	500V
C 7238	K30275200	MICA CAP.	LCQ12200J5	20p	500V
C 7239	K30275201	MICA CAP.	LCQ17201J5	200p	500V
C 7240	K30275101	MICA CAP.	LCQ12101J5	100pF	500V
C 7241	K30275560	MICA CAP.	LCQ12560J5	56pF	500V
C 7242	K30275161	MICA CAP.	LCQ17161J5	160p	500V
C 7243	K30275111	MICA CAP.	LCQ17111J5	110p	500V
C 7244	K30275180	MICA CAP.	LCQ11180J5	18pF	500V
C 7245	K30275101	MICA CAP.	LCQ12101J5	100pF	500V
C 7246	K30275390	MICA CAP.	LCQ12390J5	39pF	500V
C 7247	K30275680	MICA CAP.	LCQ12680J5	68pF	500V
C 7248	K30275470	MICA CAP.	LCQ12470J5	47pF	500V
C 7249	K30275560	MICA CAP.	LCQ12560J5	56pF	500V
C 7250	K30275560	MICA CAP.	LCQ12560J5	56pF	500V
C 7251	K30275560	MICA CAP.	LCQ12560J5	56pF	500V
C 7252	K30275220	MICA CAP.	LCQ12220J5	22pF	500V
C 7253	K30275560	MICA CAP.	LCQ12560J5	56pF	500V
C 7254	K28179002	CERAMIC CAP.	UP050F473Z-A-B	0.047uF	50V F
C 7255	K28179002	CERAMIC CAP.	UP050F473Z-A-B	0.047uF	50V F
C 7256	K28179002	CERAMIC CAP.	UP050F473Z-A-B	0.047uF	50V F
C 7257	K28179002	CERAMIC CAP.	UP050F473Z-A-B	0.047uF	50V F
C 7258	K28179002	CERAMIC CAP.	UP050F473Z-A-B	0.047uF	50V F
C 7259	K28179002	CERAMIC CAP.	UP050F473Z-A-B	0.047uF	50V F
C 7260	K28179002	CERAMIC CAP.	UP050F473Z-A-B	0.047uF	50V F
C 7261	K28179002	CERAMIC CAP.	UP050F473Z-A-B	0.047uF	50V F
C 7262	K28179002	CERAMIC CAP.	UP050F473Z-A-B	0.047uF	50V F
C 7263	K28179002	CERAMIC CAP.	UP050F473Z-A-B	0.047uF	50V F
C 7264	K28179002	CERAMIC CAP.	UP050F473Z-A-B	0.047uF	50V F
C 7265	K28179002	CERAMIC CAP.	UP050F473Z-A-B	0.047uF	50V F
C 7266	K28179002	CERAMIC CAP.	UP050F473Z-A-B	0.047uF	50V F
C 7267	K28179002	CERAMIC CAP.	UP050F473Z-A-B	0.047uF	50V F
C 7268	K28179002	CERAMIC CAP.	UP050F473Z-A-B	0.047uF	50V F
C 7269	K28179002	CERAMIC CAP.	UP050F473Z-A-B	0.047uF	50V F
C 7270	K28179002	CERAMIC CAP.	UP050F473Z-A-B	0.047uF	50V F
C 7271	K28179002	CERAMIC CAP.	UP050F473Z-A-B	0.047uF	50V F
C 7272	K26170657	CERAMIC CAP.	DD106-979F103Z50	0.01uF	50V F
C 7273	K26170657	CERAMIC CAP.	DD106-979F103Z50	0.01uF	50V F
C 7274	K26170657	CERAMIC CAP.	DD106-979F103Z50	0.01uF	50V F
C 7275	K26170657	CERAMIC CAP.	DD106-979F103Z50	0.01uF	50V F
C 7276	K26171036	CERAMIC CAP.	DD106-979SL201J50	200p	50V SL
C 7277	K26140725	CERAMIC CAP.	UAT10X104K6L36VC	0.1uF	25V X
C 7278	K26140725	CERAMIC CAP.	UAT10X104K6L36VC	0.1uF	25V X
C 7279	K26170657	CERAMIC CAP.	DD106-979F103Z50	0.01uF	50V F
C 7282	K26171027	CERAMIC CAP.	DD104-979SL820J50	82pF	50V SL
C 7283	K26171029	CERAMIC CAP.	DD105-979SL101J50	100pF	50V SL
C 7677	K22230001	CHIP CAP.	GR44-1W5R104M200PB	0.1uF	200V W5R

LPF Unit Parts List

ADD	CODE NO	DESCRIPTION	DEVICE	TYP	VAL
C 7678	K22230001	CHIP CAP.	GR44-1W5R104M200PB	0.1uF	200V W5R
D 7201	G2090223	DIODE	1SS101		
D 7202	G2090223	DIODE	1SS101		
D 7203	G2090223	DIODE	1SS101		
D 7204	G2090223	DIODE	1SS101		
D 7205	G2060004	DIODE	1SS270TJ		
D 7206	G2060004	DIODE	1SS270TJ		
D 7207	G2060004	DIODE	1SS270TJ		
D 7208	G2090464	DIODE	GM-3B		
D 7209	Q9000375	SURGE ABSORBER	DSP201M-S00B		
J 7201	P1090295	CONNECTOR	S-Q3063#01		
J 7202	P0090629	CONNECTOR	SC25-10WS		
J 7203	P0090624	CONNECTOR	SC25-05WS		
J 7204	P0090622	CONNECTOR	SC25-03WS		
J 7205	P1090295	CONNECTOR	S-Q3063#01		
J 7206	P1090295	CONNECTOR	S-Q3063#01		
J 7207	P1090295	CONNECTOR	S-Q3063#01		
J 7208	P1090210	CONNECTOR	TMP-JV		
L 7201	L0021976	COIL	3.74U T-80-2	3.74u	
L 7202	L0021977	COIL	4.57U T-80-2	4.57u	
L 7203	L0021978	COIL	2.55U T-80-2	2.55u	
L 7204	L0021979	COIL	3.2U T-80-2	3.2u	
L 7205	L0021980	COIL	1.55U T-80-2	1.55u	
L 7206	L0021981	COIL	1.92U T-80-2	1.92u	
L 7207	L0021982	COIL	0.97U T-80-2	0.97u	
L 7208	L0021983	COIL	1.27U T-80-2	1.27u	
L 7209	L0021984	COIL	0.66U T-80-2	0.66u	
L 7210	L0021985	COIL	0.82U T-80-2	0.82uH	
L 7211	L0021986	COIL	0.54U T-80-6	0.54u	
L 7212	L0021987	COIL	0.65U T-80-6	0.65u	
L 7213	L0021988A	COIL	6.0T11.5D1.2UEW R		
L 7214	L0021989A	COIL	6.0T12.5D1.2UEW R		
L 7215	L0021990A	COIL	5.0T10.0D1.2UEW R		
L 7216	L0021991A	COIL	5.0T11.5D1.2UEW R		
L 7217	L0021956	COIL	U 2001F FR9.5		
L 7218	L1190189	M.RFC	LAL03NA102K	1mH	
L 7219	L1190189	M.RFC	LAL03NA102K	1mH	
L 7220	L1190384	M.RFC	FL9H471K	470uH	
L 7221	L1190384	M.RFC	FL9H471K	470uH	
L 7222	L1190384	M.RFC	FL9H471K	470uH	
L 7223	L1190384	M.RFC	FL9H471K	470uH	
L 7224	L0020898	COIL	0.240U T25-6		
Q 7201	G3106840R	TRANSISTOR	2SA684R		
Q 7202	G3406674D	TRANSISTOR	2SD667D TZ		
Q 7203	G3050001	TRANSISTOR	BA1A4M-T		
R 7201	J22335101	METAL FILM RES.	ERG-2SJ101 100	100	2W
R 7202	J223355820	METAL FILM RES.	ERG-3SJ820 82	82	3W
R 7203	J07225103	CARBON FILM RES.	RD16TPJ103 10K	10K	1/6W
R 7204	J07225472	CARBON FILM RES.	RD16TPJ472 4.7K	4.7K	1/6W
R 7205	J07225472	CARBON FILM RES.	RD16TPJ472 4.7K	4.7K	1/6W
R 7206	J07225222	CARBON FILM RES.	RD16TPJ222 2.2K	2.2K	1/6W
R 7207	J07225223	CARBON FILM RES.	RD16TPJ223 22K	22K	1/6W
R 7208	J07225103	CARBON FILM RES.	RD16TPJ103 10K	10K	1/6W
RL7201	M1190087	RELAY	AGP2017 DC9V		DC9V
RL7202	M1190087	RELAY	AGP2017 DC9V		DC9V
RL7203	M1190087	RELAY	AGP2017 DC9V		DC9V
RL7204	M1190087	RELAY	AGP2017 DC9V		DC9V
RL7205	M1190087	RELAY	AGP2017 DC9V		DC9V
RL7206	M1190087	RELAY	AGP2017 DC9V		DC9V
RL7207	M1190087	RELAY	AGP2017 DC9V		DC9V
RL7208	M1190087	RELAY	AGP2017 DC9V		DC9V
RL7209	M1190087	RELAY	AGP2017 DC9V		DC9V
RL7210	M1190087	RELAY	AGP2017 DC9V		DC9V
RL7211	M1190087	RELAY	AGP2017 DC9V		DC9V
RL7212	M1190087	RELAY	AGP2017 DC9V		DC9V
RL7213	M1190087	RELAY	AGP2017 DC9V		DC9V
RL7214	M1190087	RELAY	AGP2017 DC9V		DC9V
RL7215	M1190087	RELAY	AGP2017 DC9V		DC9V
RL7216	M1190087	RELAY	AGP2017 DC9V		DC9V
RL7217	M1190088	RELAY	FBR321D009 DC9V		DC9V
RL7218	M1190089	RELAY	TC-112MN DC12V		DC12V
TC7201	K91000013	TRIMMER CAP.	ECV12W20X32 20PF 20p		

For Service Manuals Contact
MAURITRON TECHNICAL SERVICES
 8 Cherry Tree Rd, Chinnor
 Oxon OX9 4QY
 Tel: 01844-351694 Fax: 01844-352554
 Email: enquiries@mauritron.co.uk

For Service Manuals Contact
MAURITRON TECHNICAL SERVICES
8 Cherry Tree Rd, Chinnor
Oxon OX9 4QY
Tel: 01844-351694 Fax: 01844-352554
Email: enquiries@mauritron.co.uk

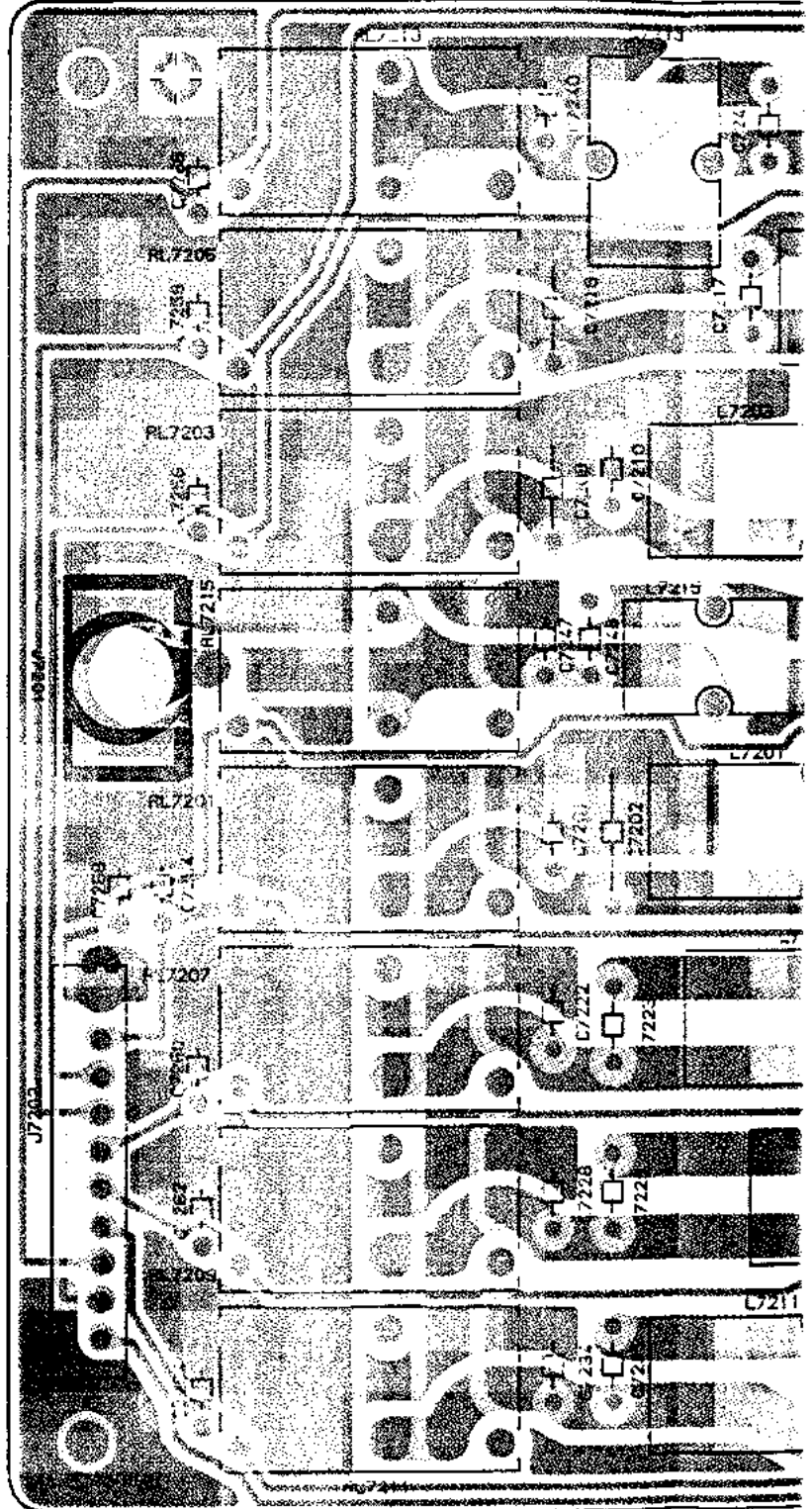

For Service Manuals Contact
MAURITRON TECHNICAL SERVICES
8 Cherry Tree Rd, Chinnor
Oxon OX9 4QY
Tel: 01844-351694 Fax: 01844-352554
Email: enquires@mauriron.co.uk

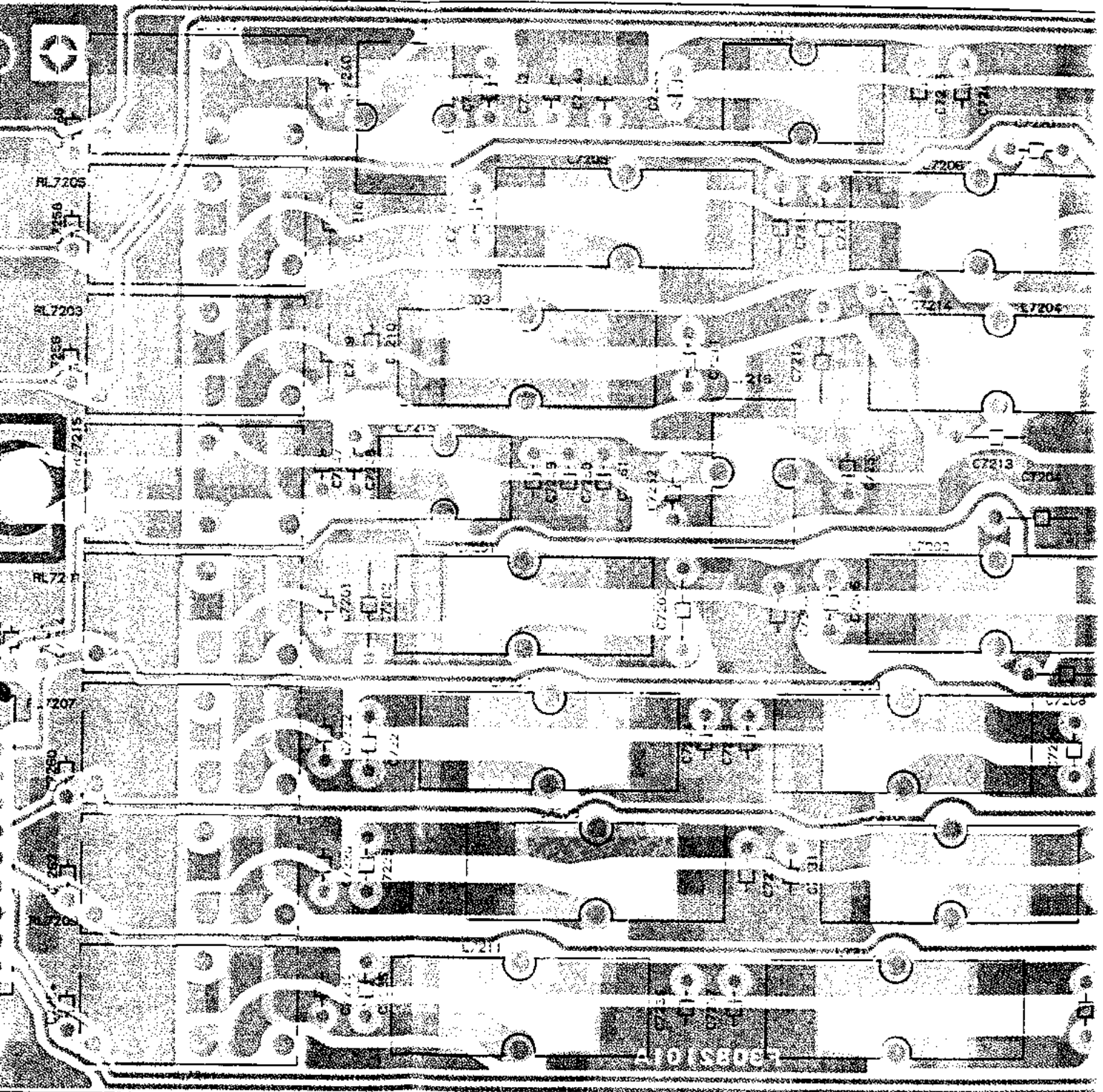

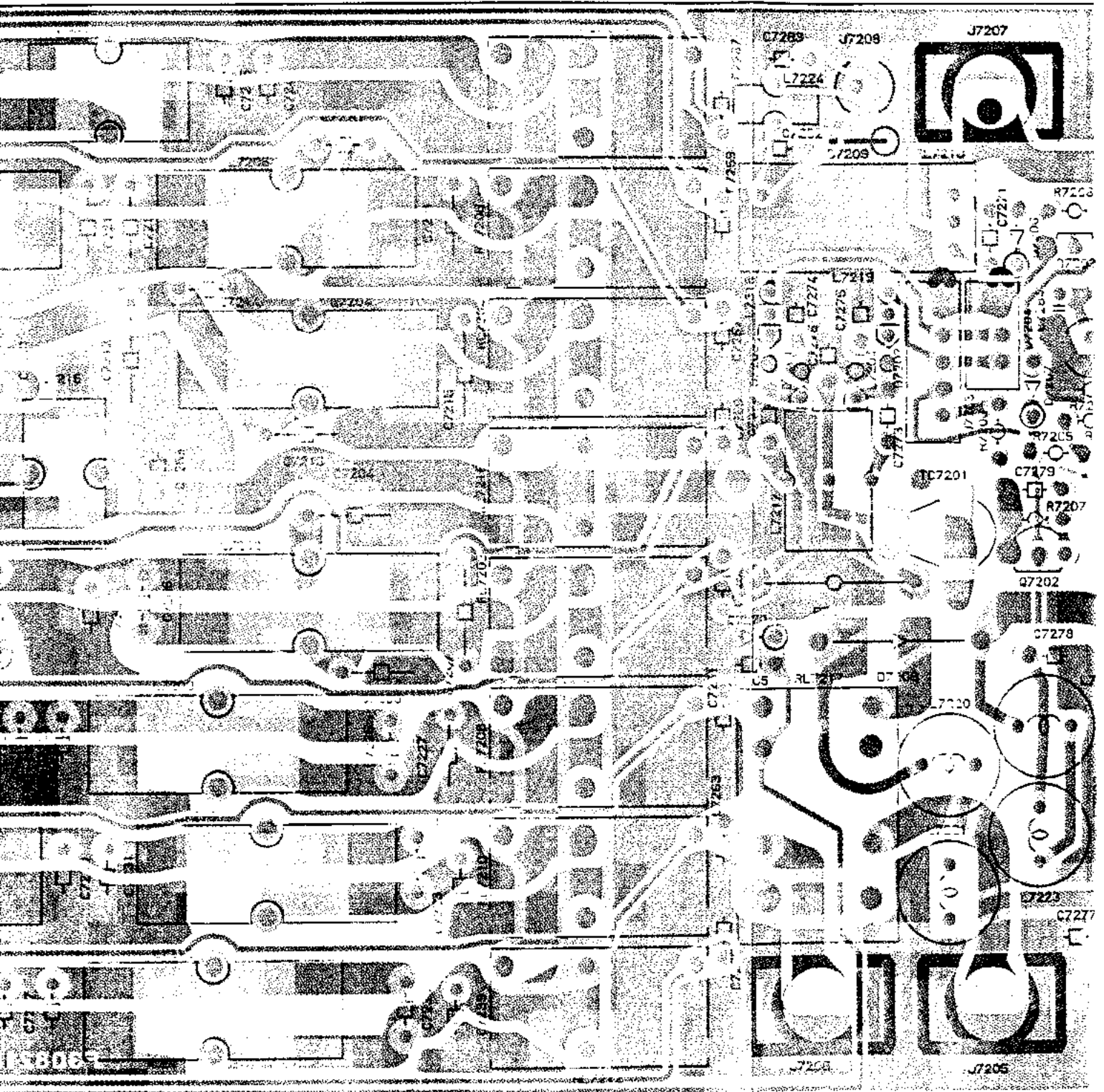

(obverse view of "component" side)

LPF Unit Board Layout

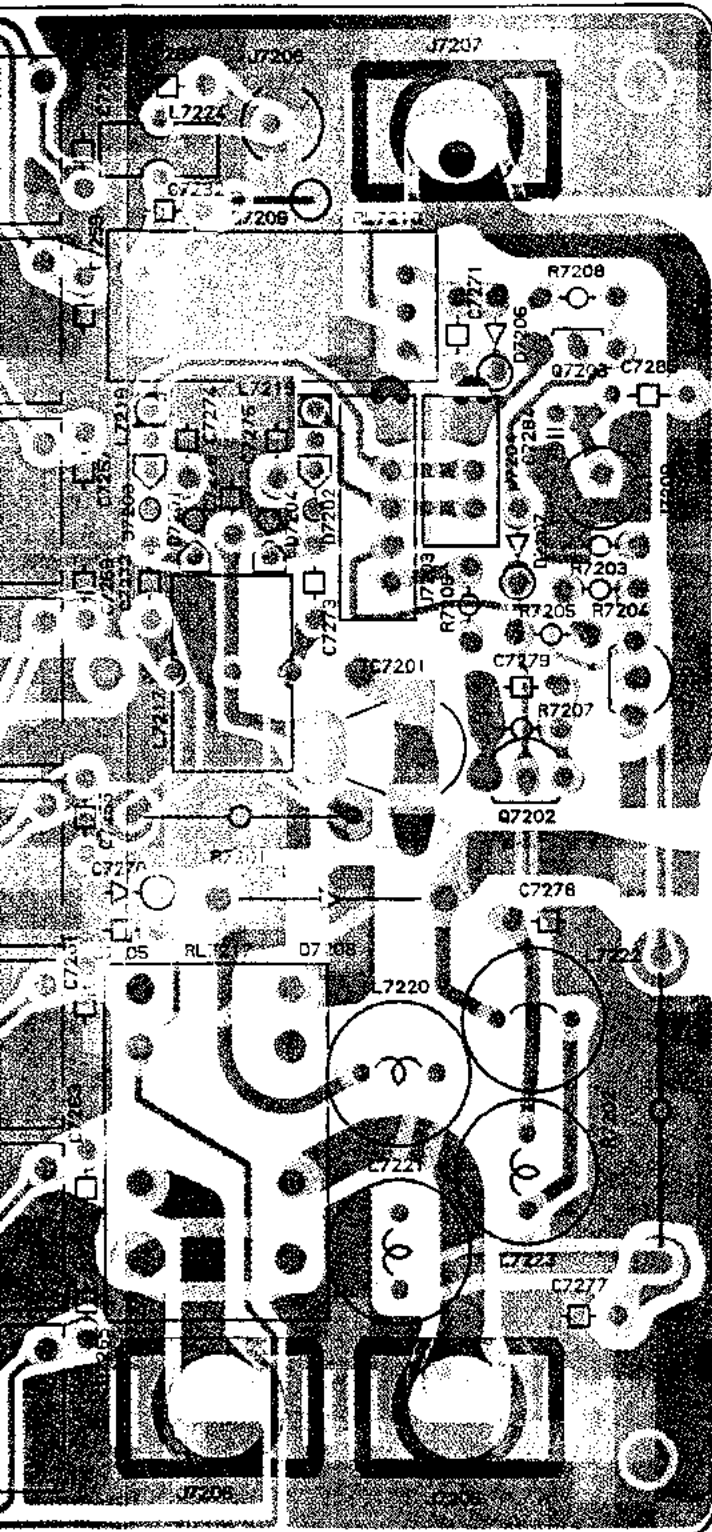

(obverse view of "component" side)

For Service Manuals Contact
MAURITRON TECHNICAL SERVICES
8 Cherry Tree Rd, Chinnor
Oxon OX9 4QY
Tel: 01844-351894 Fax: 01844-352564
Email: enquiries@maurtron.co.uk

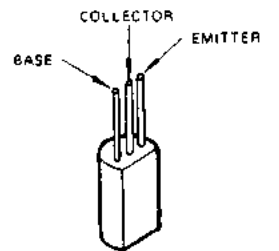
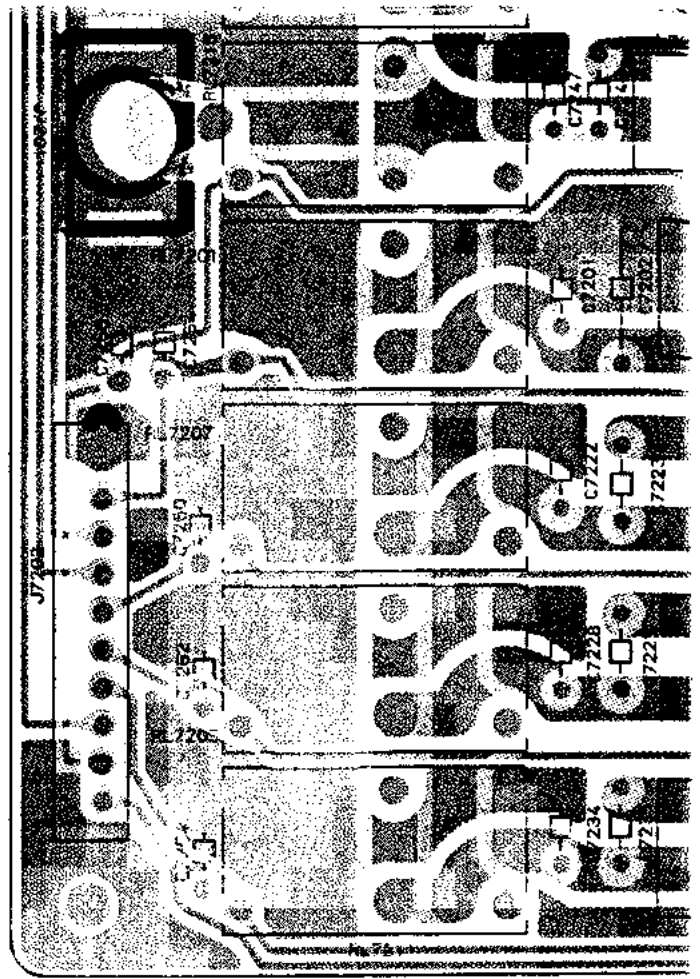

2SD667D
(Q7202)

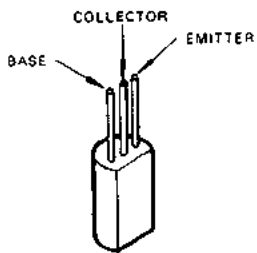
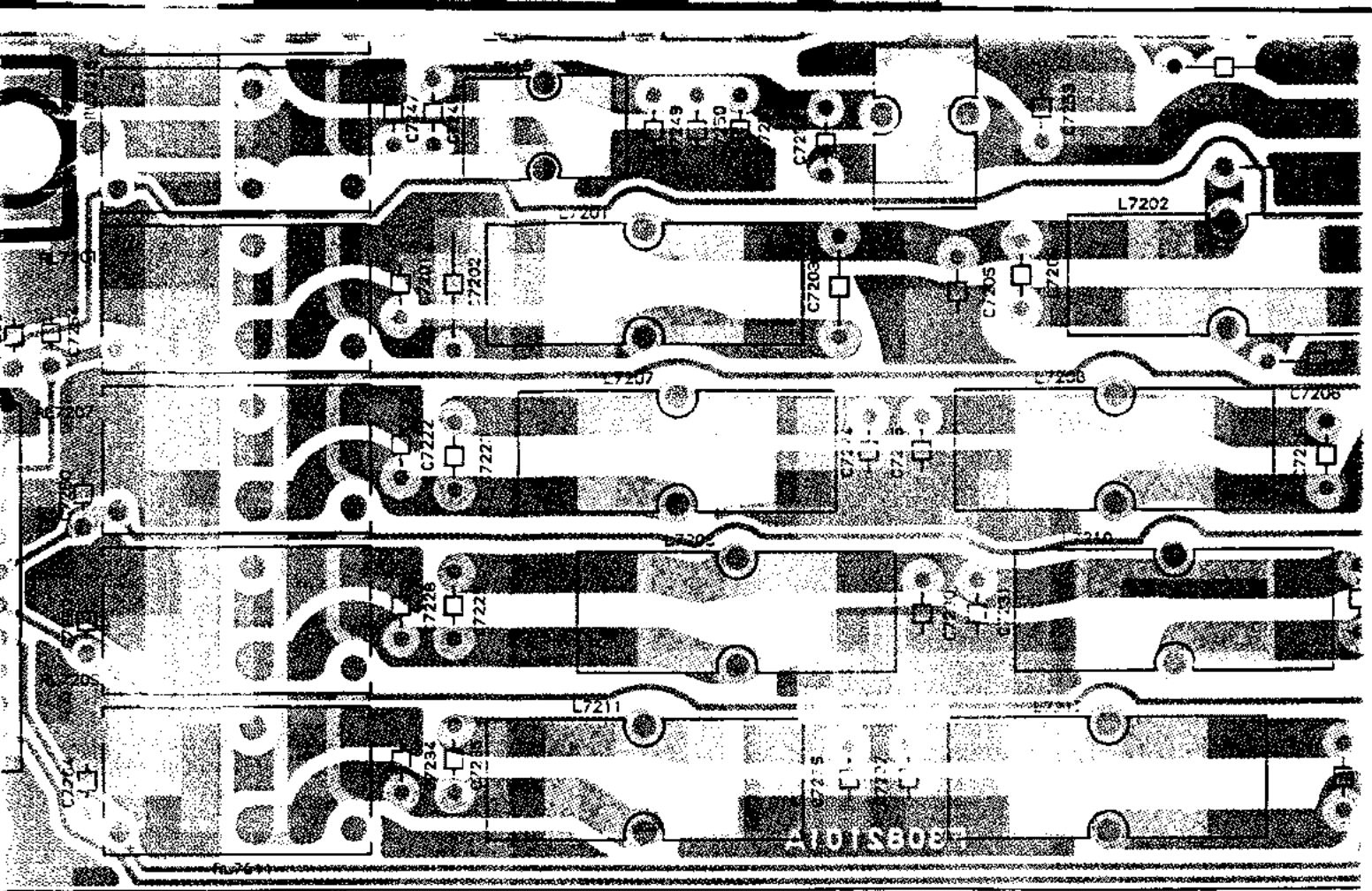

2SD667D
(Q7202)

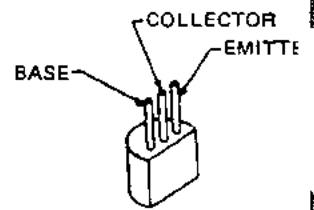

2SA684R
(Q7201)

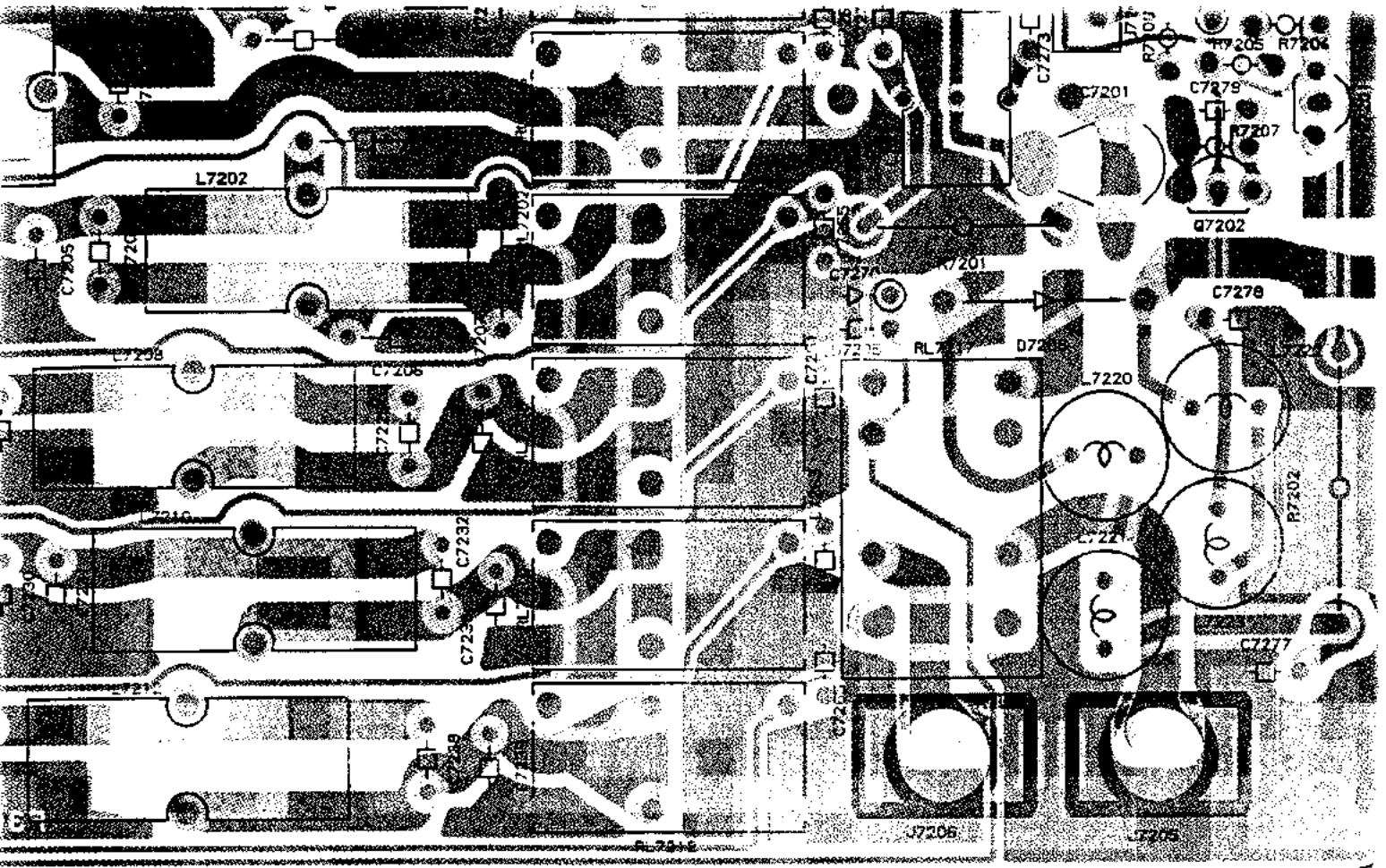

(obverse view of "component" side)

For Service Manuals Contact
MAURITRON TECHNICAL SERVICES
 8 Cherry Tree Rd, Chinnor
 Oxon OX9 4QY
 Tel: 01844 351694 Fax: 01844 352554
 Email: enquiries@mauritron.co.uk

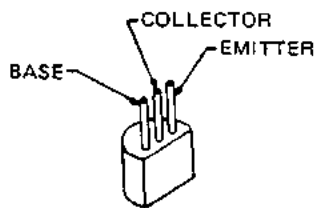

2SA684R
 (Q7201)

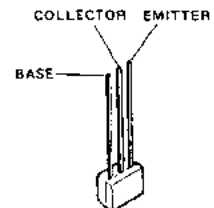

BA1A4M
 (Q7203)

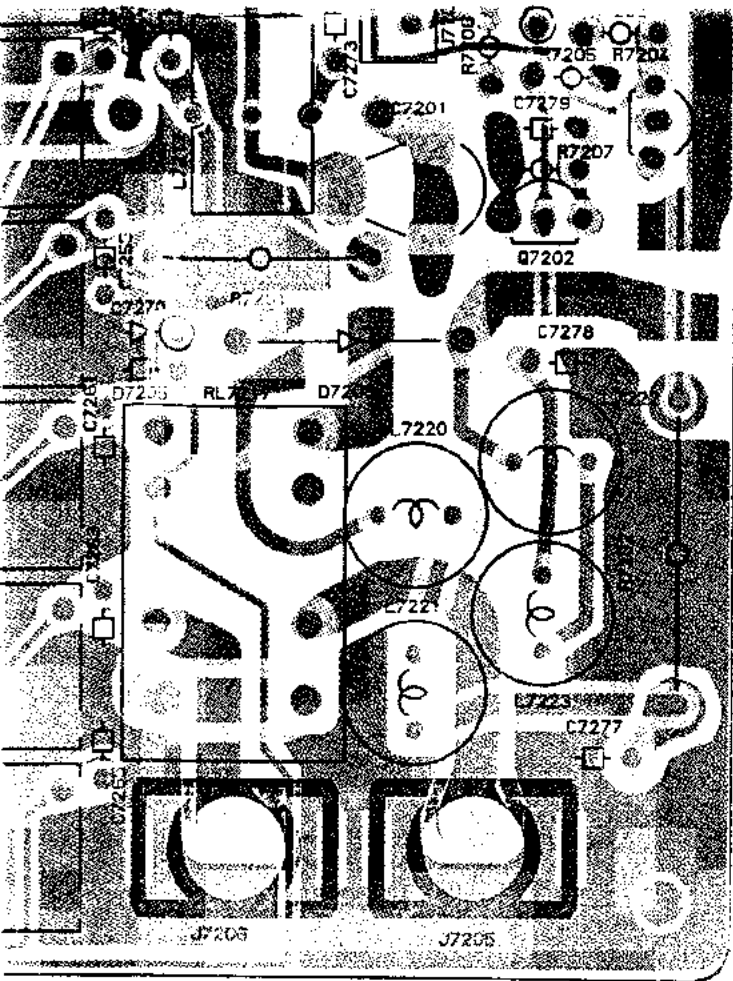

(obverse view of "component" side)

For Service Manuals Contact
MAURITRON TECHNICAL SERVICES
 8 Cherry Tree Rd, Chinnor
 Oxon OX9 4QY
 Tel: 01844-351694 Fax: 01844-352554
 Email: enquiries@mauritron.co.uk

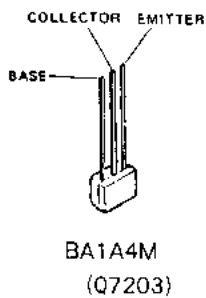

For Service Manuals Contact
MAURITRON TECHNICAL SERVICES
8 Cherry Tree Rd, Chinnor
Oxon OX9 4QY
Tel: 01844-351694 Fax: 01844-352554
Email: enquiries@mauritron.co.uk

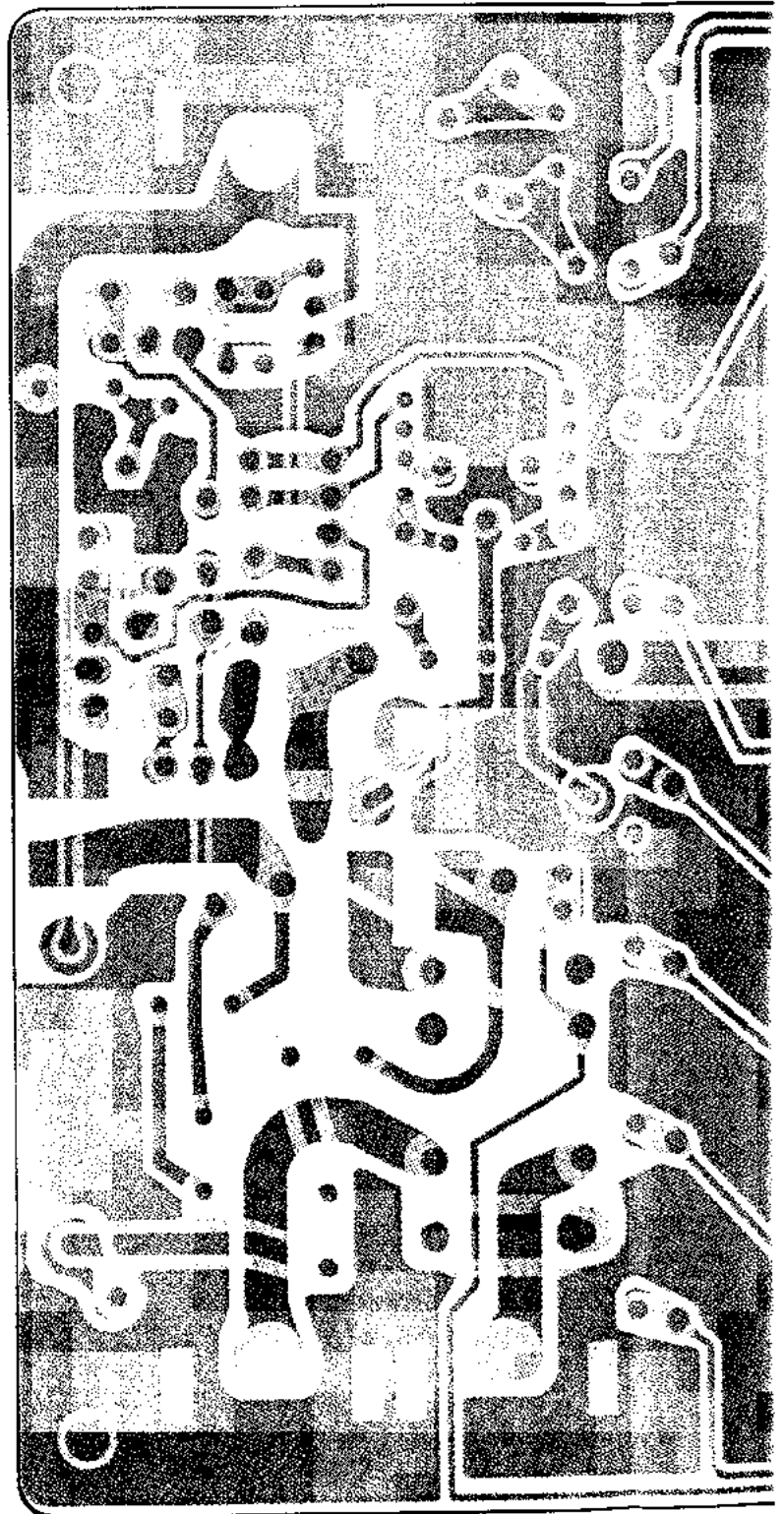

For Service Manuals Contact
MAURITRON TECHNICAL SERVICES
8 Cherry Tree Rd, Chinnor
Oxon OX9 4QY
Tel: 01844-351694 Fax: 01844-352554
Email: enquiries@mauritron.co.uk

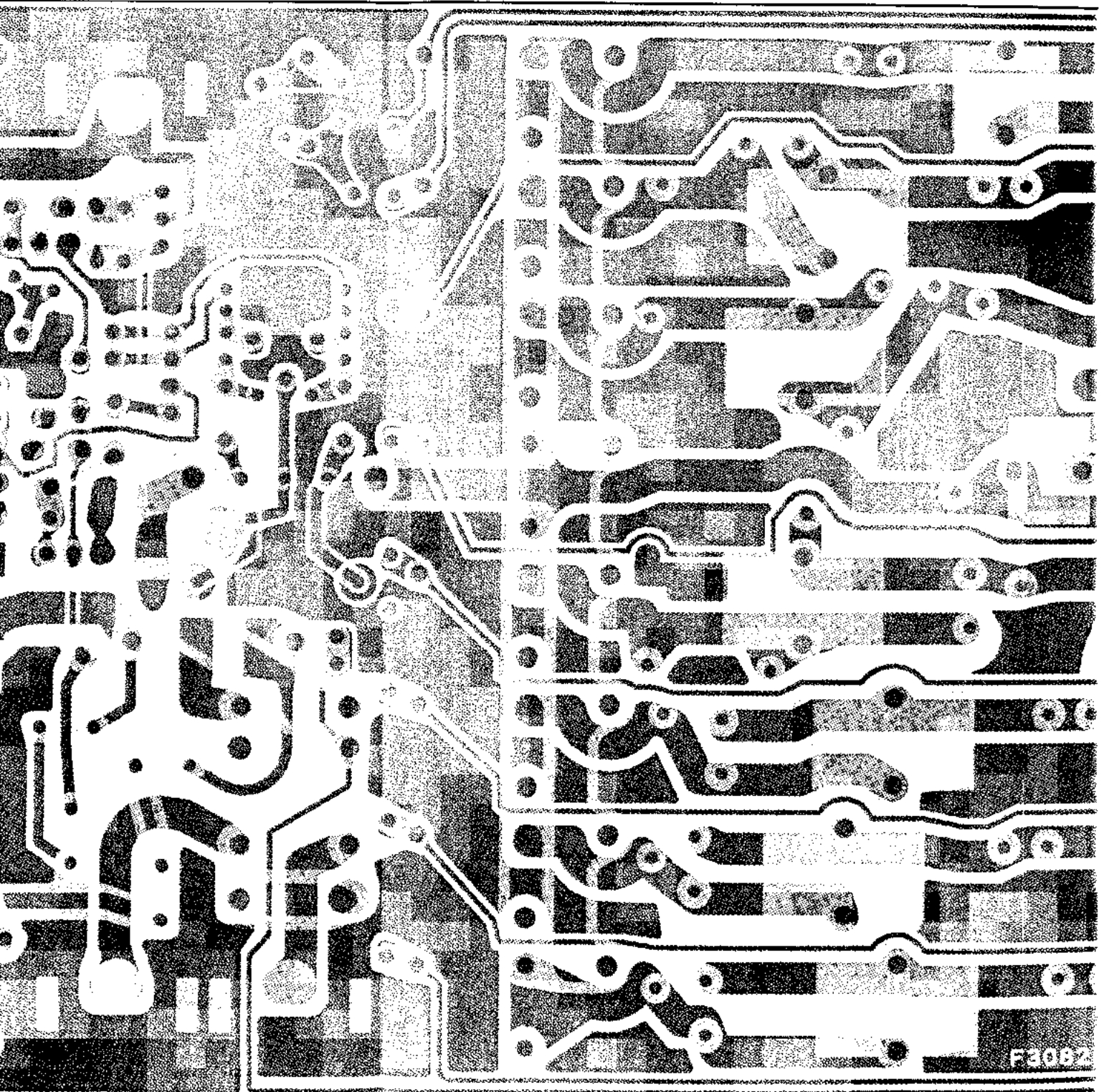

F3082

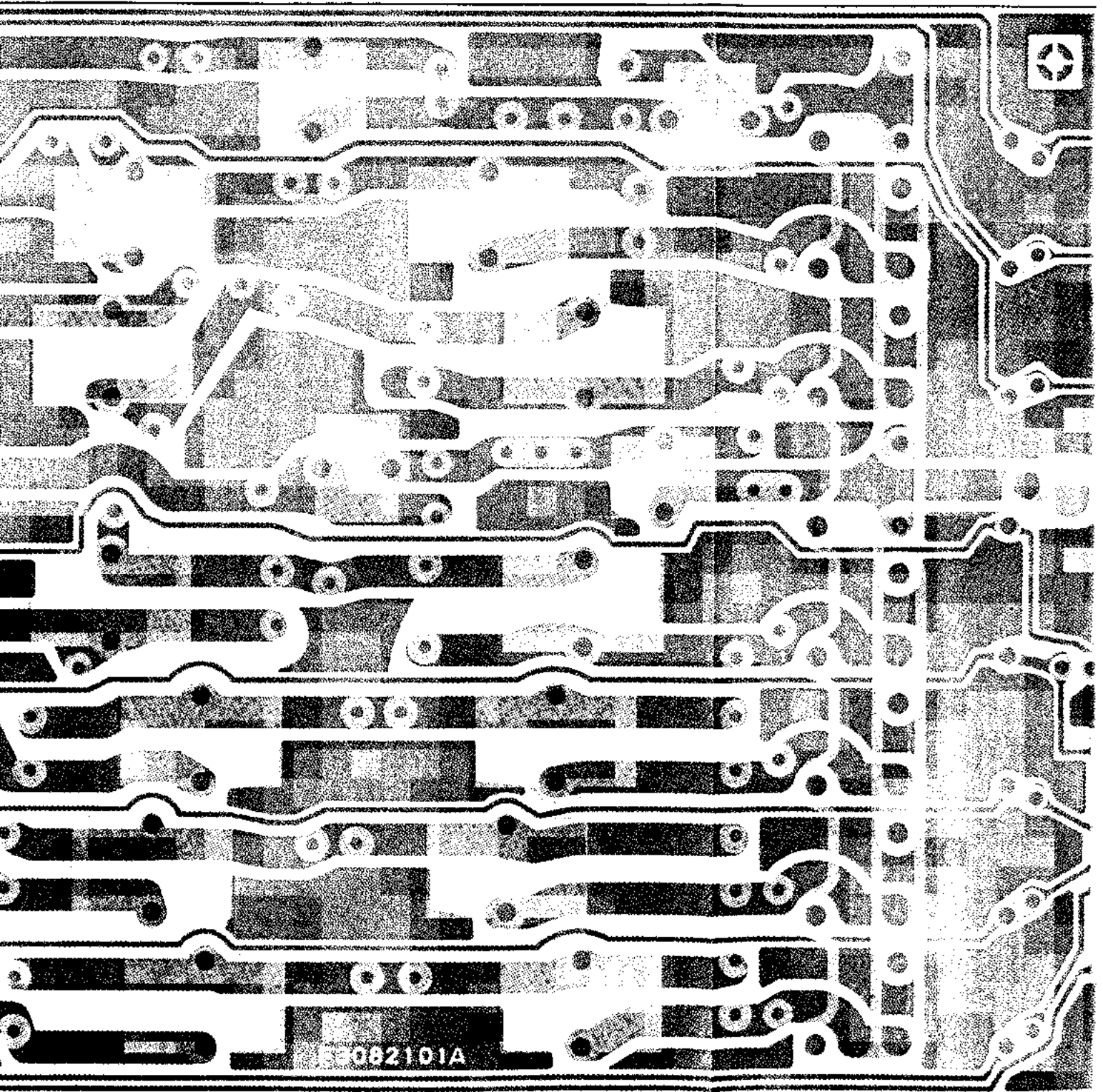

(obverse view of "solder" side)

LPF Unit Board Layout

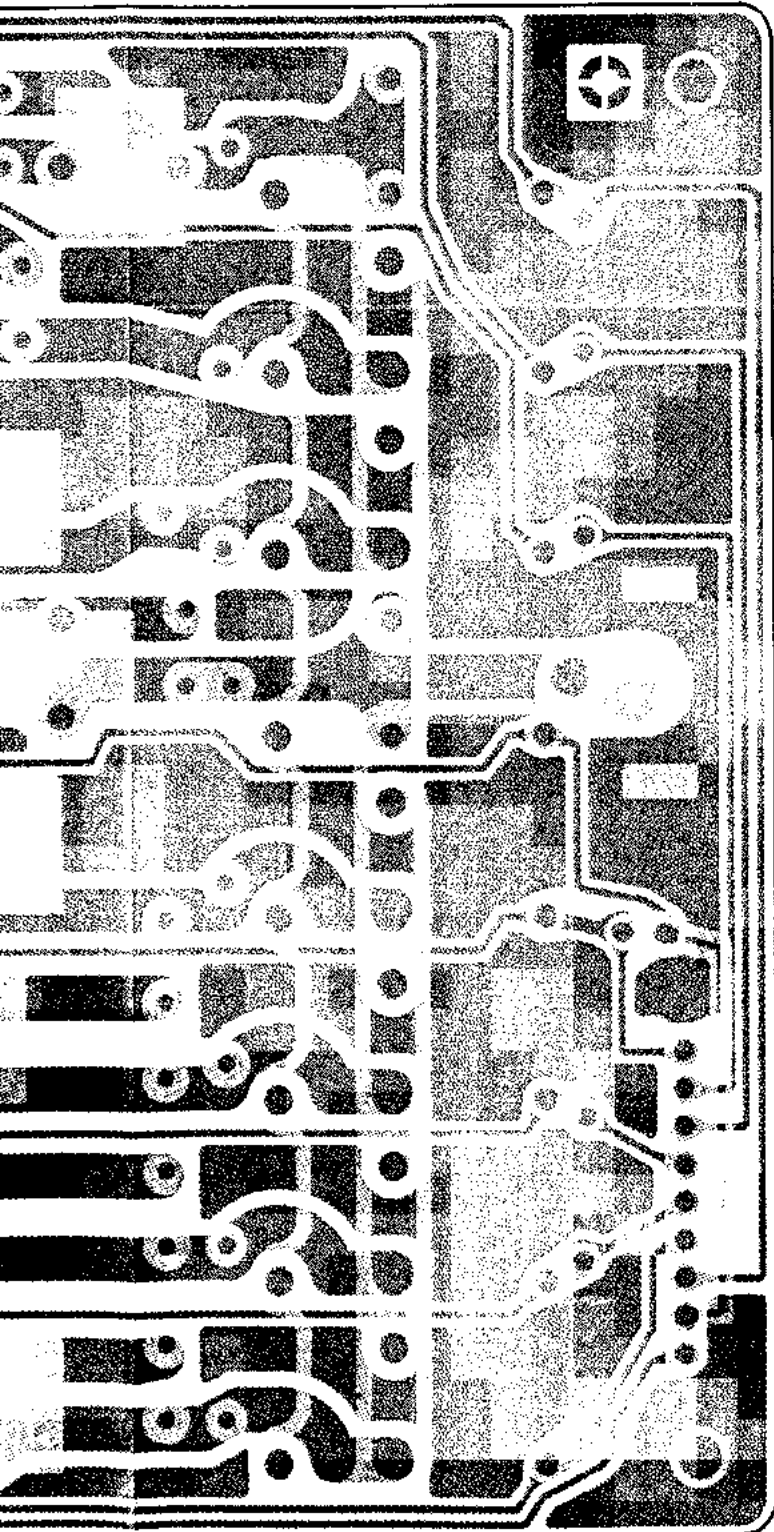

(obverse view of "solder" side)

For Service Manuals Contact
MAURITRON TECHNICAL SERVICES
8 Cherry Tree Rd, Chinnor
Oxon OX9 4QY
Tel: 01844-351694 Fax: 01844-352554
Email: enquiries@mauritron.co.uk

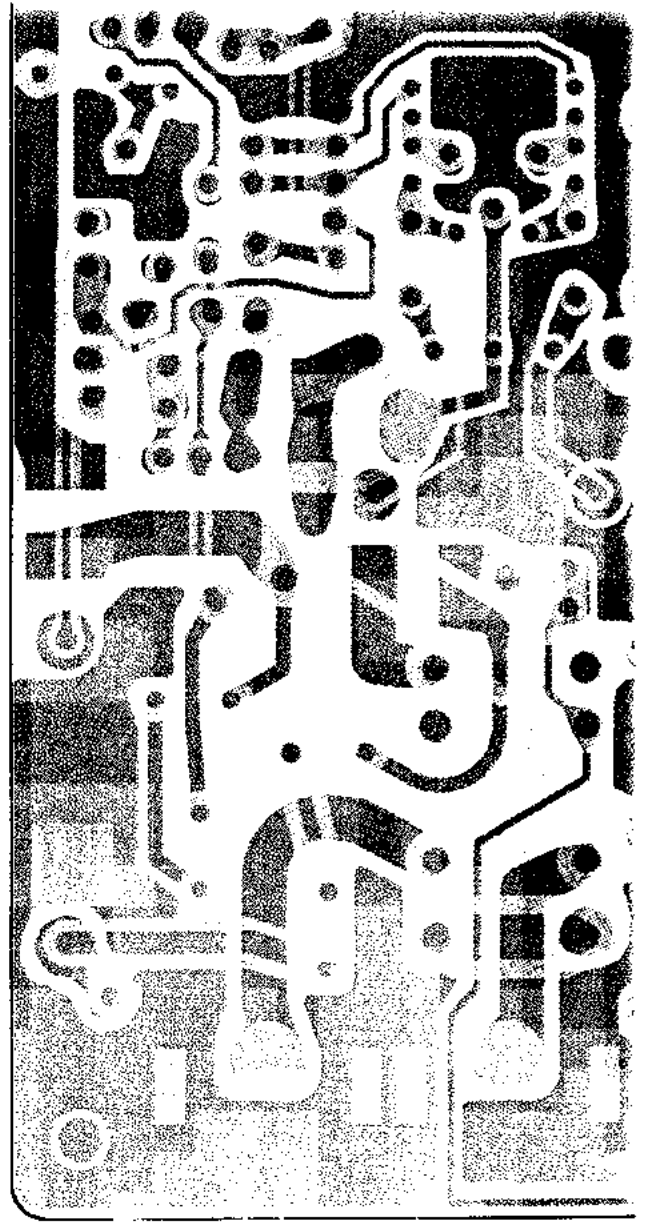

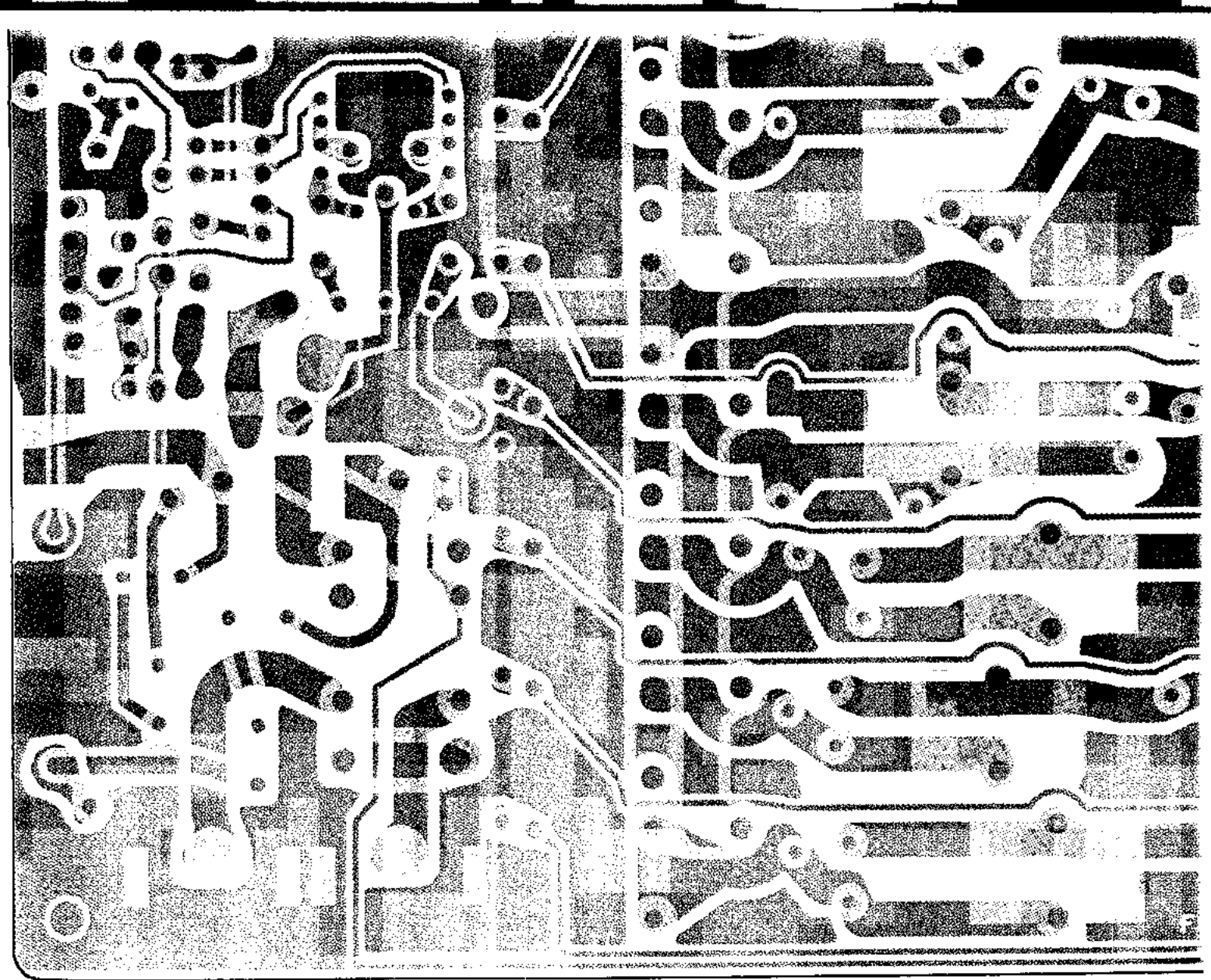

For Service Manuals Contact
MAURITRON TECHNICAL SERVICES
8 Cherry Tree Rd, Chinnor
Oxon OX9 4QY
Tel:- 01844-351694 Fax:- 01844-352554
Email:- enquiries@mauritron.co.uk

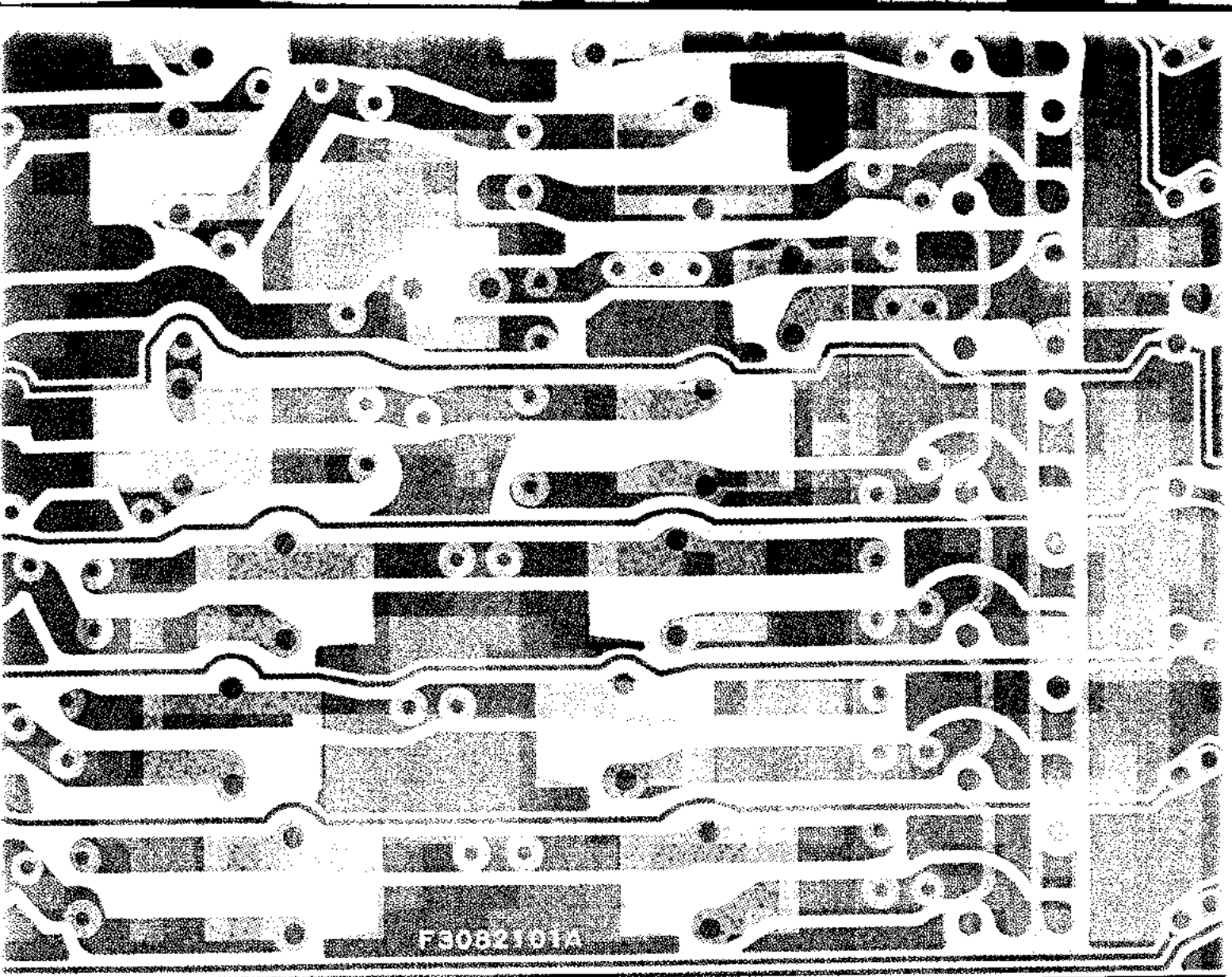

F3082101A

(obverse view of "solder

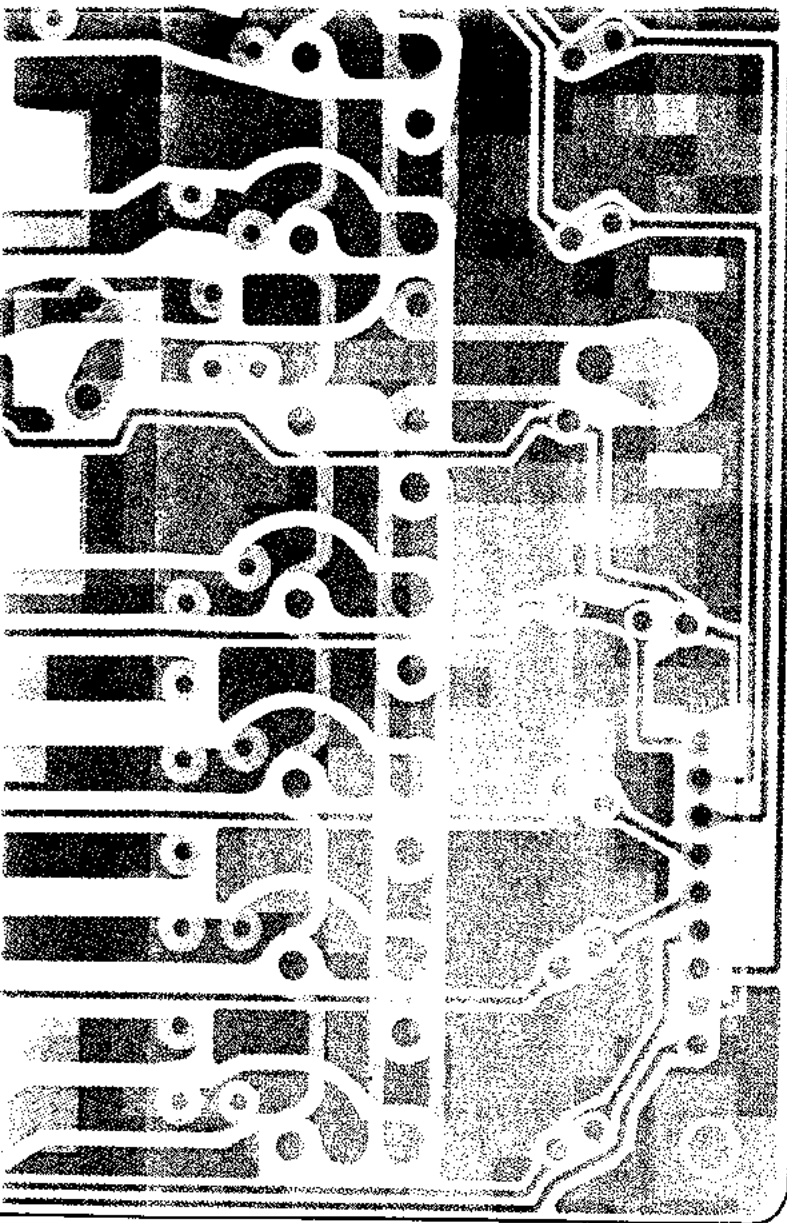

(obverse view of "solder" side)

For Service Manuals Contact
MAURITRON TECHNICAL SERVICES
8 Cherry Tree Rd, Chinnor
Oxon OX9 4QY
Tel: 01844-351694 Fax: 01844-352554
Email: enquiries@mauritron.co.uk

LPF UNIT
F3082101

For Service Manuals Contact
MAURITRON TECHNICAL SERVICES
8 Cherry Tree Rd, Chinnor
Oxon OX9 4QY
Tel: 01844-351694 Fax: 01844-352554
Email: enquiries@mauritron.co.uk

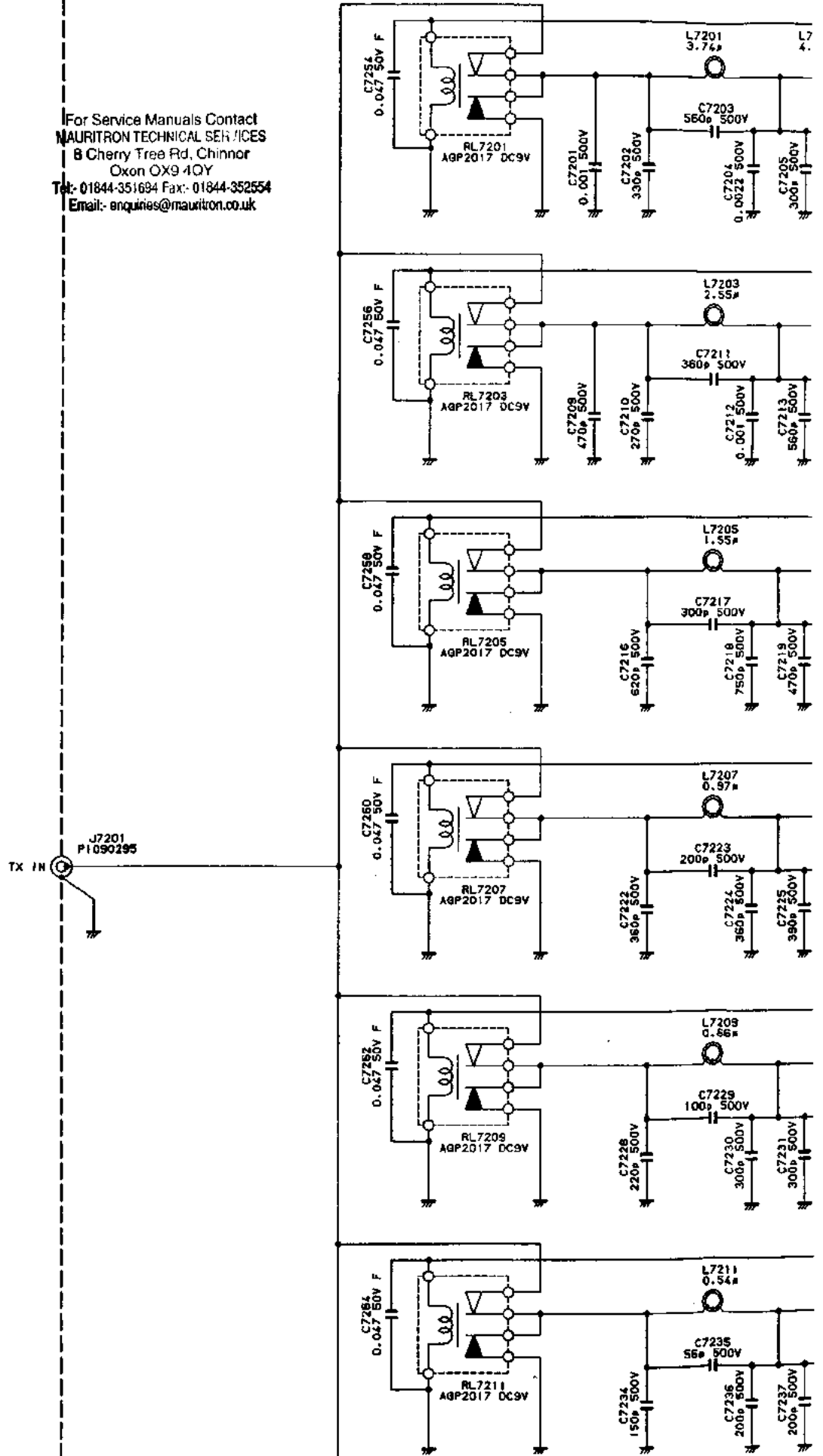

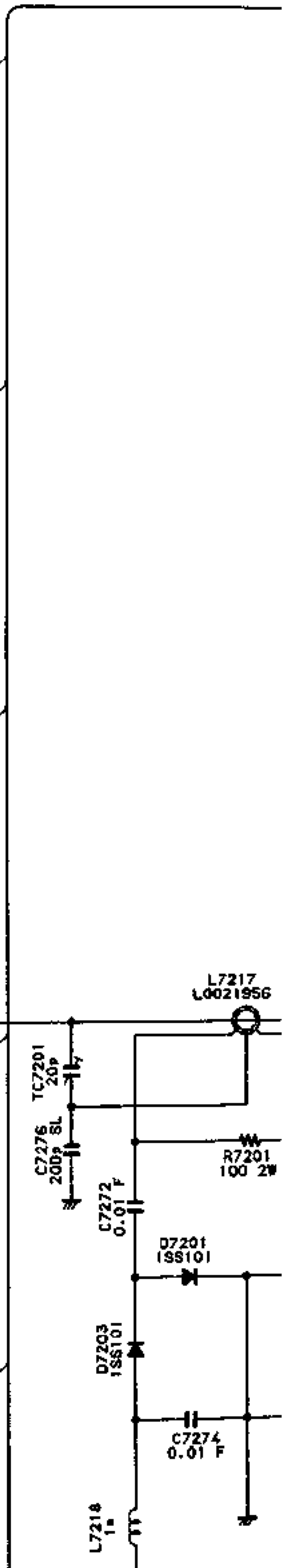
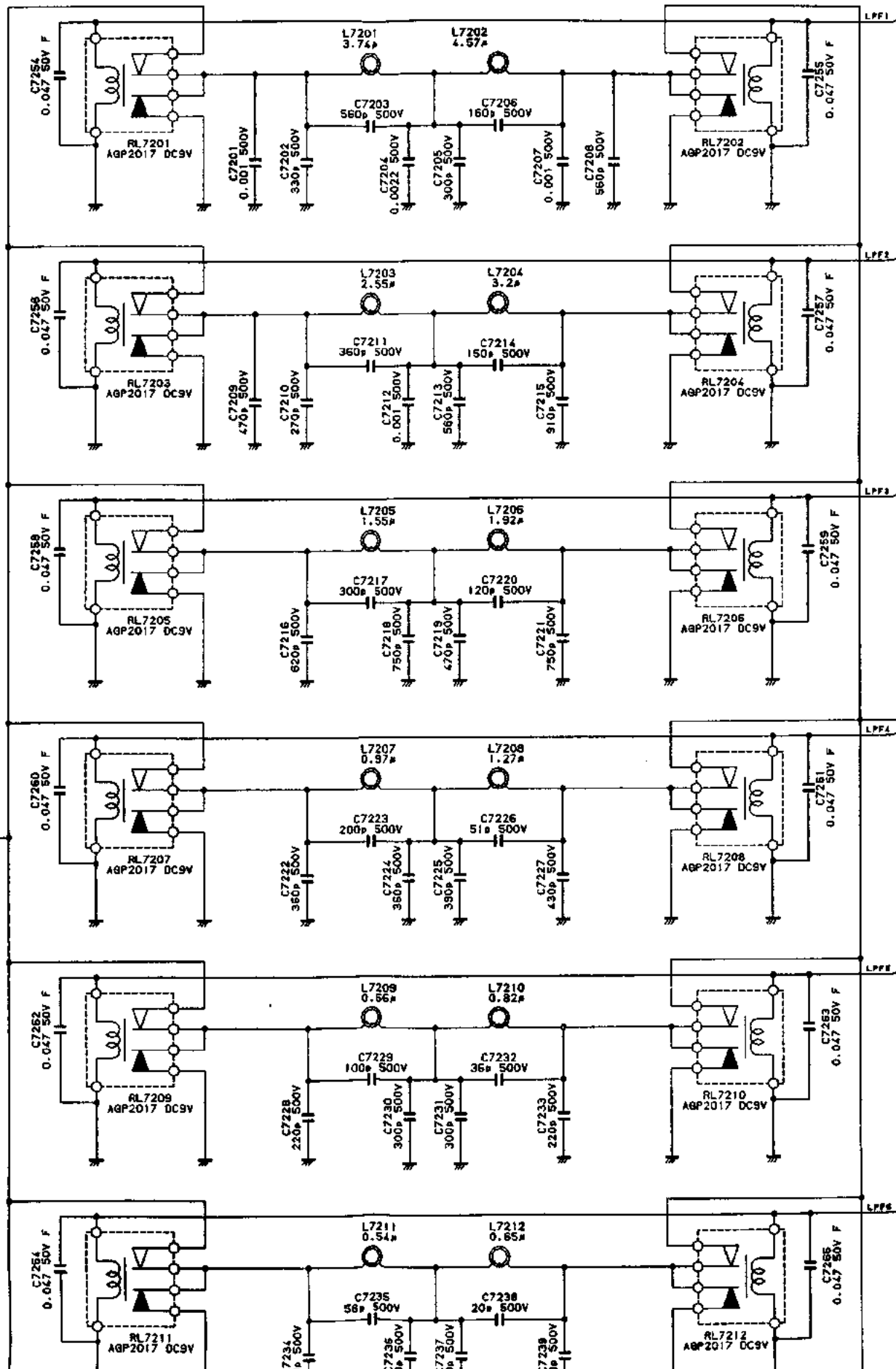

For Service Manuals Contact
MAURITRON TECHNICAL SERVICES
 8 Cherry Tree Rd, Chinnor
 Oxon OX9 4QY
 Tel: 01844-351694 Fax: 01844-352554
 Email: enquiries@mauritron.co.uk

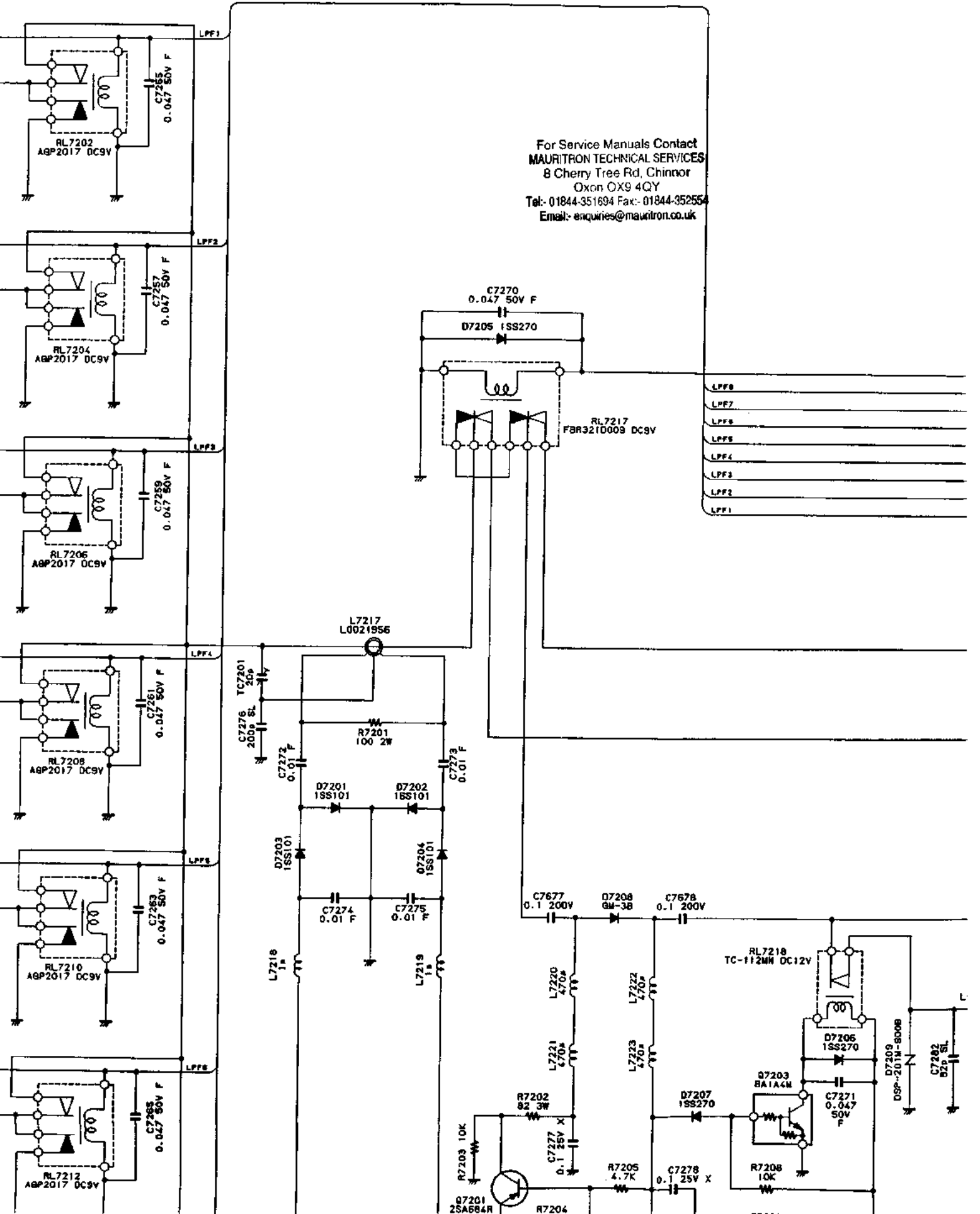

LPF Unit Schematic Diagram

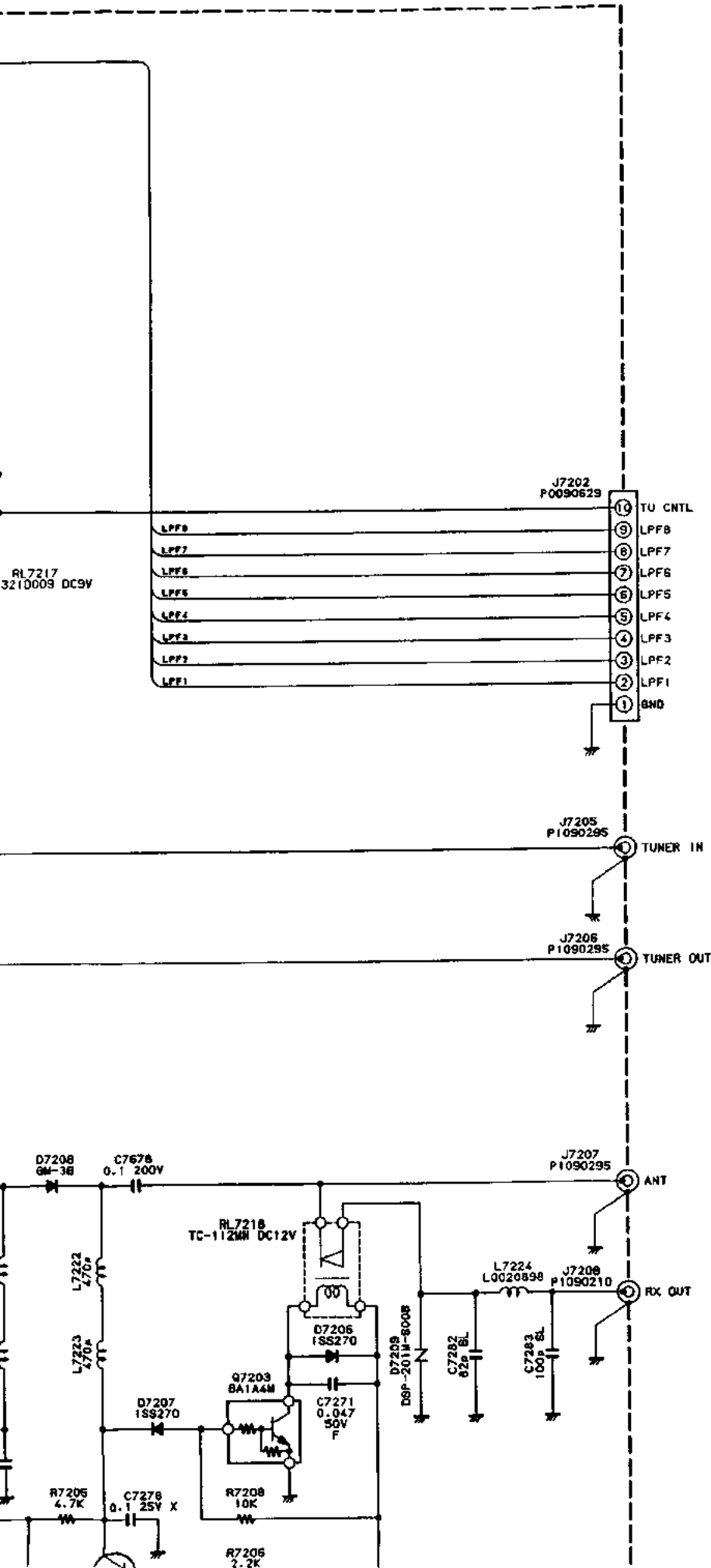

For Service Manuals Contact
MAURITRON TECHNICAL SERVICES
 8 Cherry Tree Rd, Chinnor
 Oxon OX9 4QY
 Tel: 01844-351694 Fax: 01844-352554
 Email: enquiries@mauritron.co.uk

J7201
P1090295
TX IN

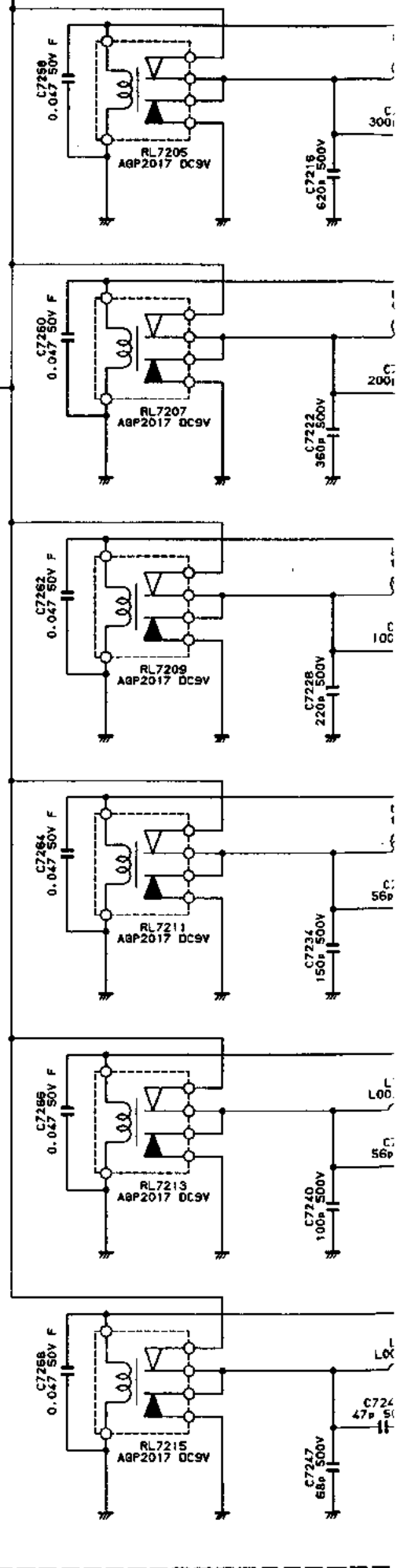

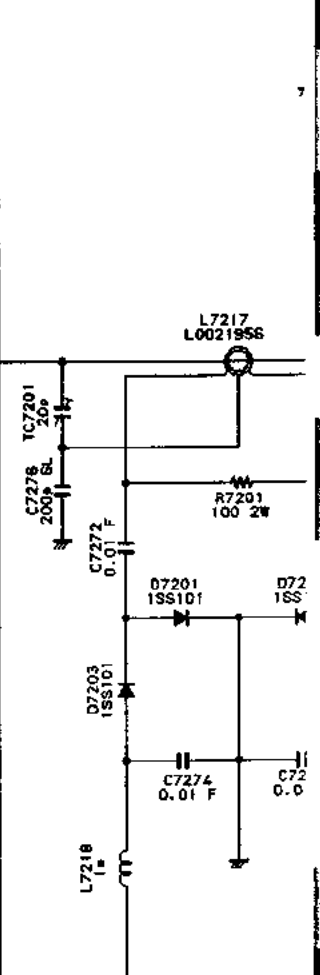
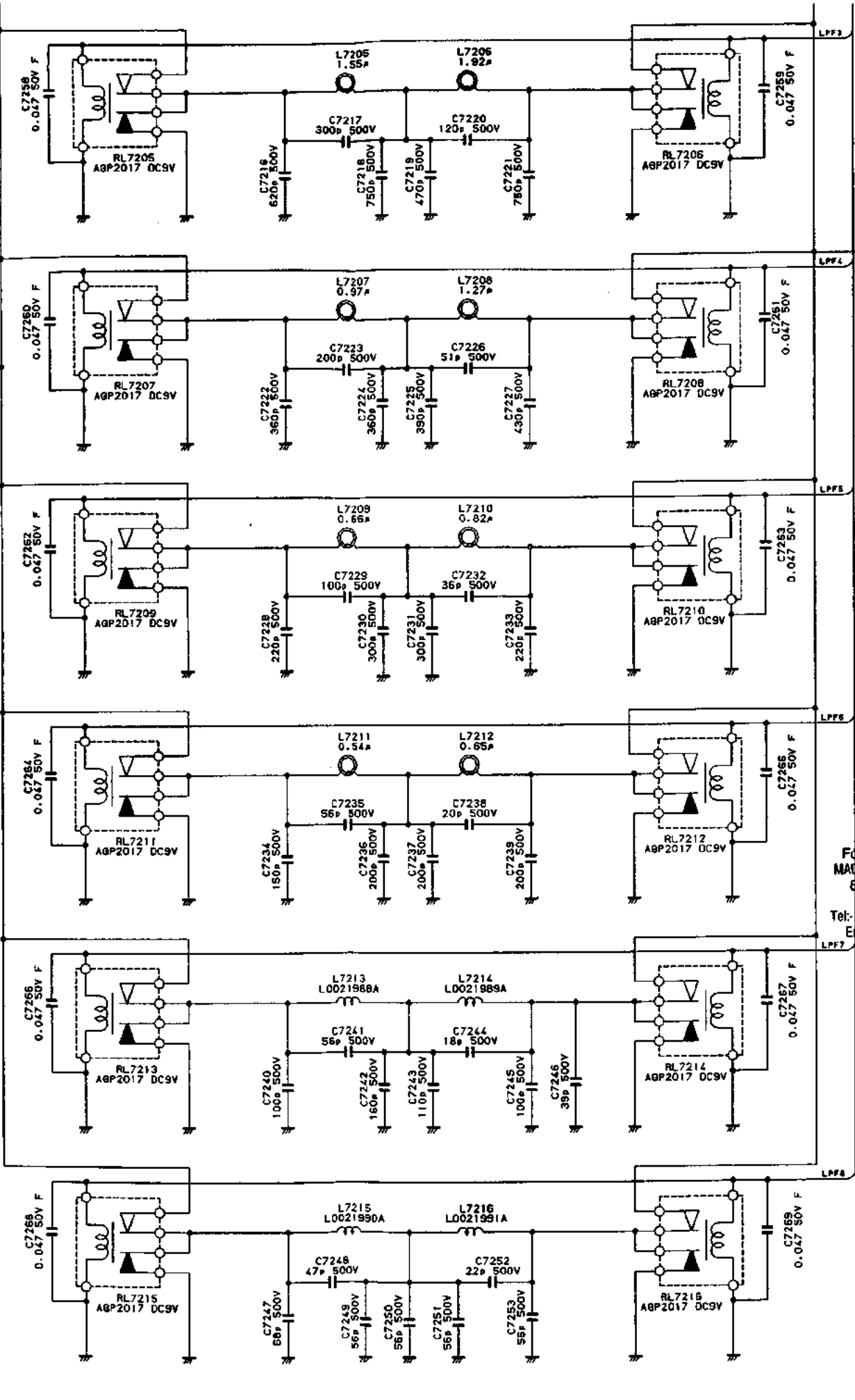

For Service Manuals Contact
MAURITRON TECHNICAL SERVICES
 8 Cherry Tree Rd, Chinnor
 Oxon OX9 4QY
 Tel: 01844-351894 Fax: 01844-352554
 Email: enquiries@mauratron.co.uk

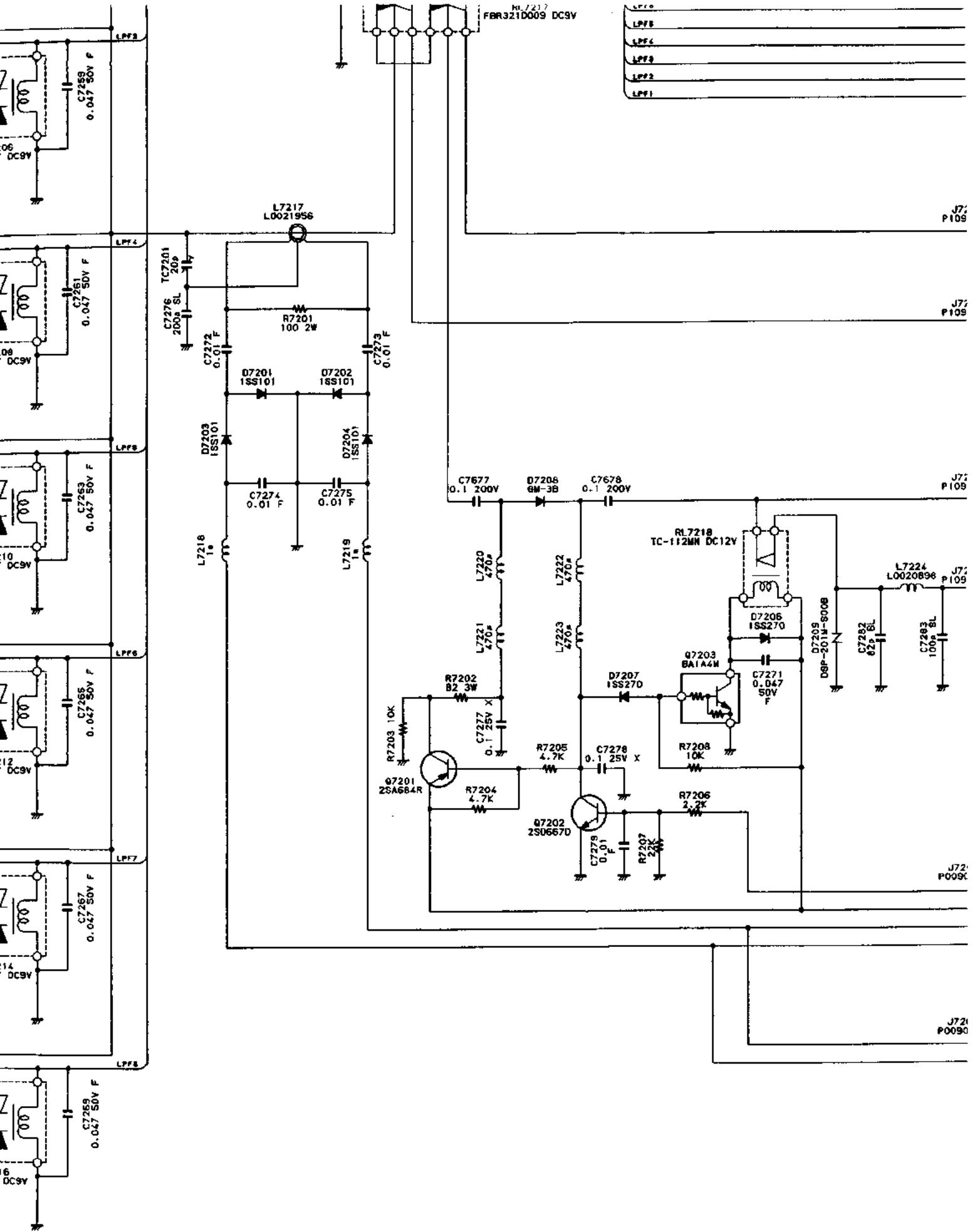

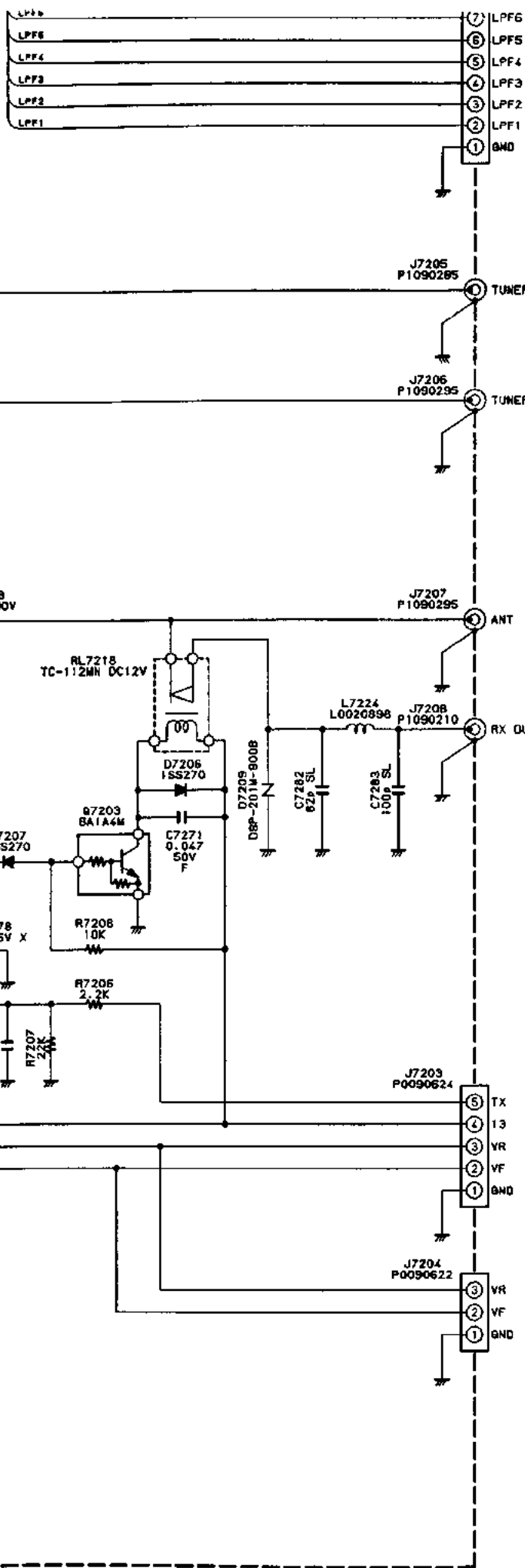

For Service Manuals Contact
MAURITRON TECHNICAL SERVICES
 8 Cherry Tree Rd. Chinnor
 Oxon OX49 4QY
 Tel: 01844-351694 Fax: 01844-352554
 Email: enquires@mauritron.co.uk

Protect Unit Parts List

ADD	CODE NO	DESCRIPTION	DEVICE	TYP VAL		
** UNIT NAME : PROTECT-UN						
C	7301	K28179001 CERAMIC CAP.	UP050B102K-A	0.001uF	50V	B
C	7302	K28129001 CERAMIC CAP.	EP050Y103N-A	0.01uF	16V	Y
C	7303	K28129001 CERAMIC CAP.	EP050Y103N-A	0.01uF	16V	Y
C	7304	K28129001 CERAMIC CAP.	EP050Y103N-A	0.01uF	16V	Y
C	7305	K28129001 CERAMIC CAP.	EP050Y103N-A	0.01uF	16V	Y
C	7306	K28179001 CERAMIC CAP.	UP050B102K-A	0.001uF	50V	B
D	7301	G2090340 DIODE	1SS83			
J	7301	P0090626 CONNECTOR	SC25-06WS			
JP	7301	T9205959 WIRE-ASSY				
JP	7302	T9205958 WIRE-ASSY				
L	7301	L0021219 COIL	1.890U 250L FR14			
L	7302	L1790119 M.RFC	LAL03TA102K	1mH		
Q	7301	G1090536 IC	UPC393C			
Q	7302	G1090749 IC	M5223P			
Q	7303	G3090079 TRANSISTOR	BA1A4P			
R	7301	J07225105 CARBON FILM RES.	RD16TPJ105 1M	1M	1/6W	
R	7302	J07225274 CARBON FILM RES.	RD16TPJ274 270K	270K	1/6W	
R	7303	J07225473 CARBON FILM RES.	RD16TPJ473 47K	47K	1/6W	
R	7304	J07225682 CARBON FILM RES.	RD16TPJ682 6.8K	6.8K	1/6W	
R	7305	J07225222 CARBON FILM RES.	RD16TPJ222 2.2K	2.2K	1/6W	
R	7306	J07225103 CARBON FILM RES.	RD16TPJ103 10K	10K	1/6W	
R	7307	J07225562 CARBON FILM RES.	RD16TPJ562 5.6K	5.6K	1/6W	
R	7308	J07225471 CARBON FILM RES.	RD16TPJ471 470	470	1/6W	
R	7309	J07225473 CARBON FILM RES.	RD16TPJ473 47K	47K	1/6W	
R	7310	J07225474 CARBON FILM RES.	RD16TPJ474 470K	470K	1/6W	
R	7311	J07225224 CARBON FILM RES.	RD16TPJ224 220K	220K	1/6W	
R	7312	J22359001 METAL FILM RES.	ERG-3SJ390 39	39	3W	
TP	7301	Q5000051 TP-L	TP-L IPS-1139			
VR	7301	J50770222 POT.	H0652A009-2.2K	2.2K		

For Service Manuals Contact
MAURITRON TECHNICAL SERVICES
 8 Cherry Tree Rd, Chinnor
 Oxon OX9 4QY
 Tel: 01844-351694 Fax: 01844-352554
 Email: enquiries@maurtron.co.uk

For Service Manuals Contact
MAURITRON TECHNICAL SERVICES
8 Cherry Tree Rd, Chinnor
Oxon OX9 4QY
Tel:- 01844-351634 Fax:- 01844-352554
Email:- enquiries@mauritron.co.uk

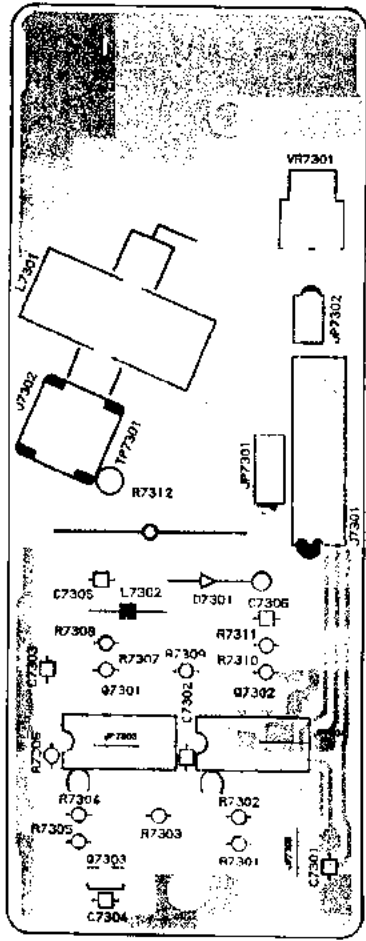

(obverse view of "component" side)

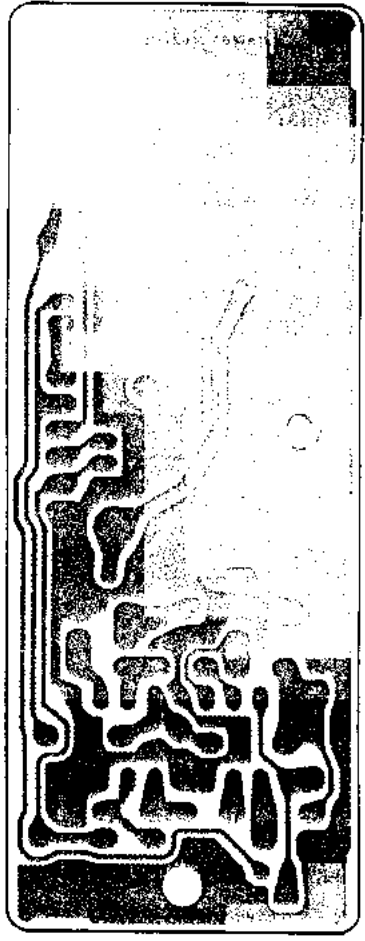

(obverse view of "solder" side)

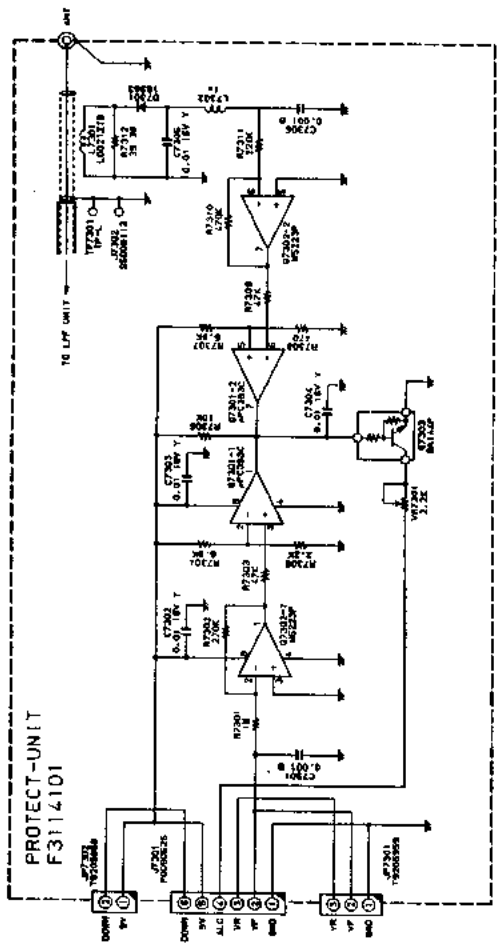

(schematic diagram)

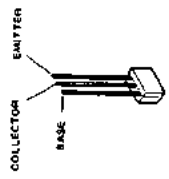

BA1A4P
(07303)

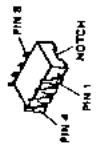

IC6393C
(07301)
M5223P
(07302)

For Service Manuals Contact
MAURITRON TECHNICAL SERVICES
8 Cherry Tree Rd, Chinnor
Oxon OX9 4QY
Tel: 01844-351694 Fax: 01844-352554
Email: enquiries@mauritron.co.uk

Tuner Main Unit Parts List

ADD	CODE NO	DESCRIPTION	DEVICE	TYP VAL
** UNIT NAME : TUNER-MAIN				
C	7401	K30355201 MICA CAP DML4 201J30	DML4 201J30	200p 3KV
C	7402	K30355401 MICA CAP DML4 401J30	DML4 401J30	400p 3KV
C	7403	K30355201 MICA CAP DML4 201J30	DML4 201J30	200p 3KV
C	7404	K30355401 MICA CAP DML4 401J30	DML4 401J30	400p 3KV
C	7405	K40129049 AL. ELECTRO. CAP.	RE2-16V471M	470UF 470uF 16V
C	7406	K13179009 CERAMIC CAP.	DD110F473Z50	0.047uF 50V F
C	7407	K13179009 CERAMIC CAP.	DD110F473Z50	0.047uF 50V F
C	7408	K40129049 AL. ELECTRO. CAP.	RE2-16V471M	470UF 470uF 16V
C	7409	K28129001 CERAMIC CAP.	EP050Y103N-A	0.01uF 16V Y
C	7410	K28129001 CERAMIC CAP.	EP050Y103N-A	0.01uF 16V Y
C	7411	K28129001 CERAMIC CAP.	EP050Y103N-A	0.01uF 16V Y
C	7412	K28129001 CERAMIC CAP.	EP050Y103N-A	0.01uF 16V Y
C	7413	K28179002 CERAMIC CAP.	UP050F473Z-A-B	0.047uF 50V F
C	7414	K28179002 CERAMIC CAP.	UP050F473Z-A-B	0.047uF 50V F
C	7415	K40179041 AL. ELECTRO. CAP.	RE2-50V100M	10UF 10uF 50V
C	7416	K40179041 AL. ELECTRO. CAP.	RE2-50V100M	10UF 10uF 50V
C	7417	K28179002 CERAMIC CAP.	UP050F473Z-A-B	0.047uF 50V F
C	7418	K28179002 CERAMIC CAP.	UP050F473Z-A-B	0.047uF 50V F
C	7419	K40179041 AL. ELECTRO. CAP.	RE2-50V100M	10UF 10uF 50V
C	7420	K40179041 AL. ELECTRO. CAP.	RE2-50V100M	10UF 10uF 50V
C	7421	K13179008 CERAMIC CAP.	DD106F103Z50	0.01uF 50V F
C	7422	K00175471 CERAMIC CAP.	DD109SL471J50	470pF 50V SL
C	7423	K13179008 CERAMIC CAP.	DD106F103Z50	0.01uF 50V F
C	7424	K13179008 CERAMIC CAP.	DD106F103Z50	0.01uF 50V F
C	7425	K13179008 CERAMIC CAP.	DD106F103Z50	0.01uF 50V F
C	7426	K13179008 CERAMIC CAP.	DD106F103Z50	0.01uF 50V F
C	7427	K13179008 CERAMIC CAP.	DD106F103Z50	0.01uF 50V F
C	7428	K13179008 CERAMIC CAP.	DD106F103Z50	0.01uF 50V F
C	7429	K13179008 CERAMIC CAP.	DD106F103Z50	0.01uF 50V F
C	7430	K13179008 CERAMIC CAP.	DD106F103Z50	0.01uF 50V F
C	7431	K13179008 CERAMIC CAP.	DD106F103Z50	0.01uF 50V F
C	7432	K40129042 AL. ELECTRO. CAP.	RE2-16V101M	100UF 100uF 16V
C	7433	K13179008 CERAMIC CAP.	DD106F103Z50	0.01uF 50V F
C	7434	K13179008 CERAMIC CAP.	DD106F103Z50	0.01uF 50V F
C	7435	K13179008 CERAMIC CAP.	DD106F103Z50	0.01uF 50V F
C	7436	K13179008 CERAMIC CAP.	DD106F103Z50	0.01uF 50V F
C	7437	K28129001 CERAMIC CAP.	EP050Y103N-A	0.01uF 16V Y
C	7438	K28129001 CERAMIC CAP.	EP050Y103N-A	0.01uF 16V Y
C	7439	K28129001 CERAMIC CAP.	EP050Y103N-A	0.01uF 16V Y
C	7440	K28129001 CERAMIC CAP.	EP050Y103N-A	0.01uF 16V Y
C	7441	K28129001 CERAMIC CAP.	EP050Y103N-A	0.01uF 16V Y
CB7401	K80000002	CAPACITOR BLOCK CAYF1036Z50	CAYF1036Z50	CAYF1036Z50 0
CB7402	K80000002	CAPACITOR BLOCK CAYF1036Z50	CAYF1036Z50	CAYF1036Z50 0
CB7403	K80000002	CAPACITOR BLOCK CAYF1036Z50	CAYF1036Z50	CAYF1036Z50 0
D	7401	Q9000371 SURGE ABSORBER	DSA-301LA	
D	7406	G2090223 DIODE	1SS101	
D	7407	G2090223 DIODE	1SS101	
D	7408	G2090408 DIODE	1SS270	
D	7409	G2090408 DIODE	1SS270	
D	7410	G2090408 DIODE	1SS270	
D	7411	G2090408 DIODE	1SS270	
J	7401	P1090295 CONNECTOR	S-Q3063#01	
J	7402	P1090295 CONNECTOR	S-Q3063#01	
JP7401	T9205913	WIRE-ASSY		
JP7402	T9205914	WIRE-ASSY		
JP7403	T9205915	WIRE-ASSY		
L	7401	L0021948 COIL	1.5T15D2.0PVF R	
L	7402	L0021949 COIL	2.5T15D2.0PVF R	
L	7403	L0021950 COIL	4.5T15D2.0PVF R	
L	7404	L0021951 COIL	5.5T19D2.0PVF R	
L	7405	L0021952 COIL	9.5T19D2.0PVF R	
L	7406	L0021953 COIL	9.5T30D2.0PVF R	
L	7407	L0021954 COIL	16.5T30D2.0PVF R	
L	7408	L1190133 M. RFC	LAL04NA101K	100uH
L	7409	L0021955 COIL	U 2001F FR9.5	
L	7410	L1190040 M. RFC	S4-102	1mH
MO7401	Q9000526	MOTOR POT. RK16312M0 50KB	RK16312M0 50KB	50KB
MO7402	Q9000526	MOTOR POT. RK16312M0 50KB	RK16312M0 50KB	50KB
Q	7401	G1090946 IC	MC7809CT	
Q	7402	G1091004 IC	MB3763	
Q	7403	G1091004 IC	MB3763	
Q	7404	G1090536 IC	UPC393C	
Q	7405	G3801040J FET	2SK104J	
Q	7406	G3801040J FET	2SK104J	
Q	7407	G3329010L TRANSISTOR	2SC2901L	
Q	7408	G3329010L TRANSISTOR	2SC2901L	
Q	7409	G1091007 IC	HD74HC00P	
Q	7410	G1091006 IC	HD74HC74P	
Q	7411	G1090029 IC	MC14071BCP	

Tuner Main Unit Parts List

ADD	CODE NO	DESCRIPTION	DEVICE	TYP	VAL
R 7403	J01275240	CARBPM FILM RES.	RD12TJ240	24	24 1/2W
R 7404	J02245103	CARBON FILM RES.	RD14SJ103	10K	10K 1/4W
R 7405	J02245103	CARBON FILM RES.	RD14SJ103	10K	10K 1/4W
R 7406	J02245103	CARBON FILM RES.	RD14SJ103	10K	10K 1/4W
R 7407	J02245103	CARBON FILM RES.	RD14SJ103	10K	10K 1/4W
R 7408	J02245104	CARBON FILM RES.	RD14SJ104	100K	100K 1/4W
R 7409	J02245104	CARBON FILM RES.	RD14SJ104	100K	100K 1/4W
R 7410	J02245471	CARBON FILM RES.	RD14SJ471	470	470 1/4W
R 7411	J02245471	CARBON FILM RES.	RD14SJ471	470	470 1/4W
R 7412	J02245223	CARBON FILM RES.	RD14SJ223	22K	22K 1/4W
R 7413	J02245223	CARBON FILM RES.	RD14SJ223	22K	22K 1/4W
R 7414	J02245123	CARBON FILM RES.	RD14SJ123	12K	12K 1/4W
R 7415	J02245123	CARBON FILM RES.	RD14SJ123	12K	12K 1/4W
R 7416	J02245471	CARBON FILM RES.	RD14SJ471	470	470 1/4W
R 7417	J02245471	CARBON FILM RES.	RD14SJ471	470	470 1/4W
R 7418	J02245101	CARBON FILM RES.	RD14SJ101	100	100 1/4W
R 7419	J02245101	CARBON FILM RES.	RD14SJ101	100	100 1/4W
R 7420	J02245103	CARBON FILM RES.	RD14SJ103	10K	10K 1/4W
R 7421	J07225104	CARBON FILM RES.	RD16TPJ104	100K	100K 1/6W
R 7422	J07225104	CARBON FILM RES.	RD16TPJ104	100K	100K 1/6W
R 7423	J07225104	CARBON FILM RES.	RD16TPJ104	100K	100K 1/6W
R 7424	J07225104	CARBON FILM RES.	RD16TPJ104	100K	100K 1/6W
R 7425	J07225102	CARBON FILM RES.	RD16TPJ102	1K	1K 1/6W
R 7426	J07225102	CARBON FILM RES.	RD16TPJ102	1K	1K 1/6W
R 7427	J07225102	CARBON FILM RES.	RD16TPJ102	1K	1K 1/6W
R 7428	J07225102	CARBON FILM RES.	RD16TPJ102	1K	1K 1/6W
RL7401	M1190075	RELAY	AGP2003	DC12V	DC12V
RL7402	M1190075	RELAY	AGP2003	DC12V	DC12V
RL7403	M1190075	RELAY	AGP2003	DC12V	DC12V
RL7404	M1190075	RELAY	AGP2003	DC12V	DC12V
RL7405	M1190075	RELAY	AGP2003	DC12V	DC12V
RL7406	M1190075	RELAY	AGP2003	DC12V	DC12V
RL7407	M1190075	RELAY	AGP2003	DC12V	DC12V
RL7408	M1190075	RELAY	AGP2003	DC12V	DC12V
RL7409	M1190075	RELAY	AGP2003	DC12V	DC12V
RL7410	M1190075	RELAY	AGP2003	DC12V	DC12V
RL7411	M1190075	RELAY	AGP2003	DC12V	DC12V
RL7412	M1190075	RELAY	AGP2003	DC12V	DC12V
TC7401	K91000013	TRIMMER CAP.	ECV1ZW20X32	20PF	20p
VC7401	K90000047	TRIMMER CAP.	YB-250-065		250p
VC7402	K90000047	TRIMMER CAP.	YB-250-065		250p

For Service Manuals Contact
MAURITRON TECHNICAL SERVICES
 8 Cherry Tree Rd, Chinnor
 Oxon OX9 4QY
 Tel: 01844-351694 Fax: 01844-352554
 Email: enquiries@mauritron.co.uk

For Service Manuals Contact
MAURITRON TECHNICAL SERVICES
8 Cherry Tree Rd, Chinnor
Oxon OX9 4QY
Tel: 01844-351694 Fax: 01844-352554
Email: enquiries@mauriron.co.uk

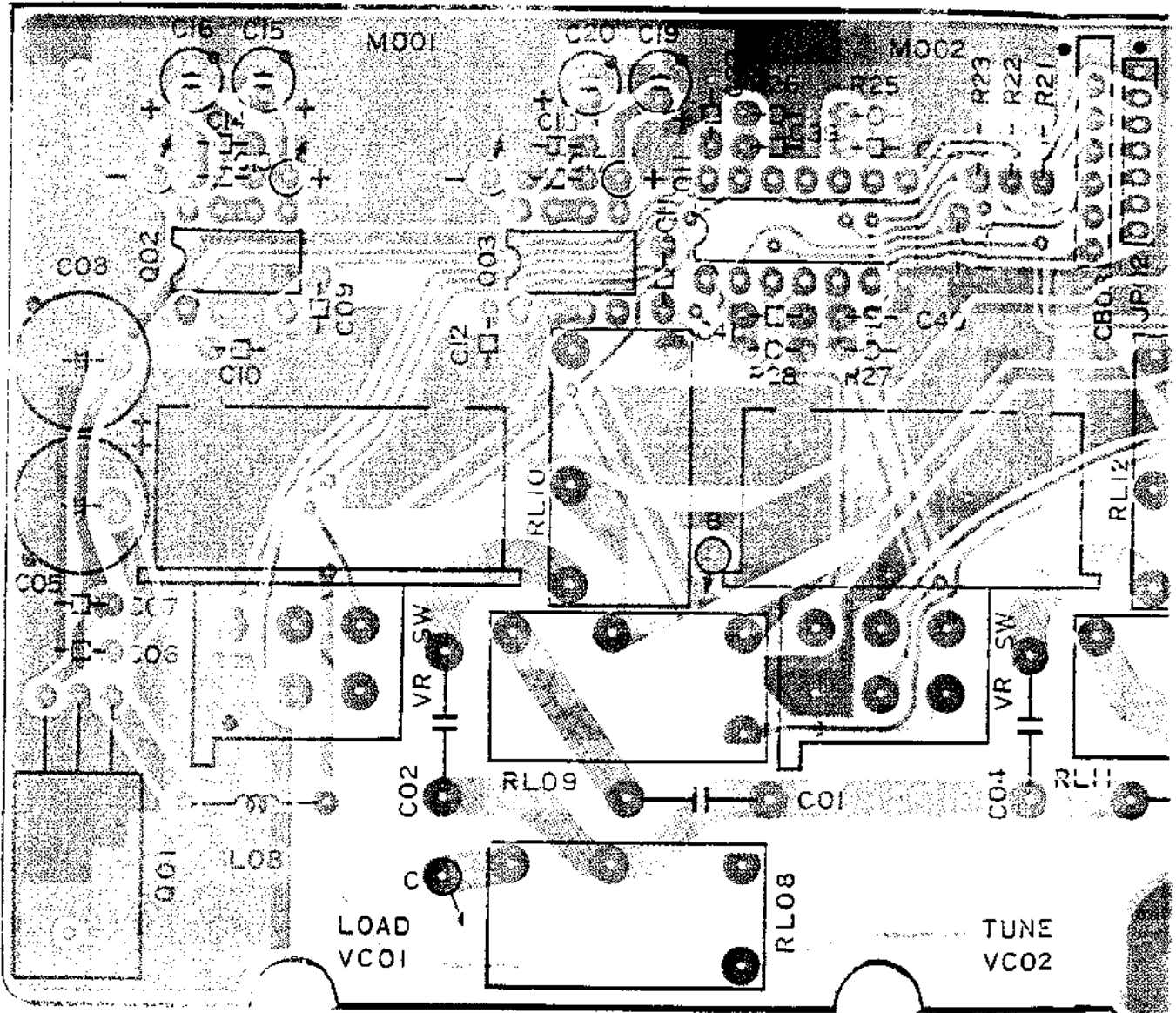

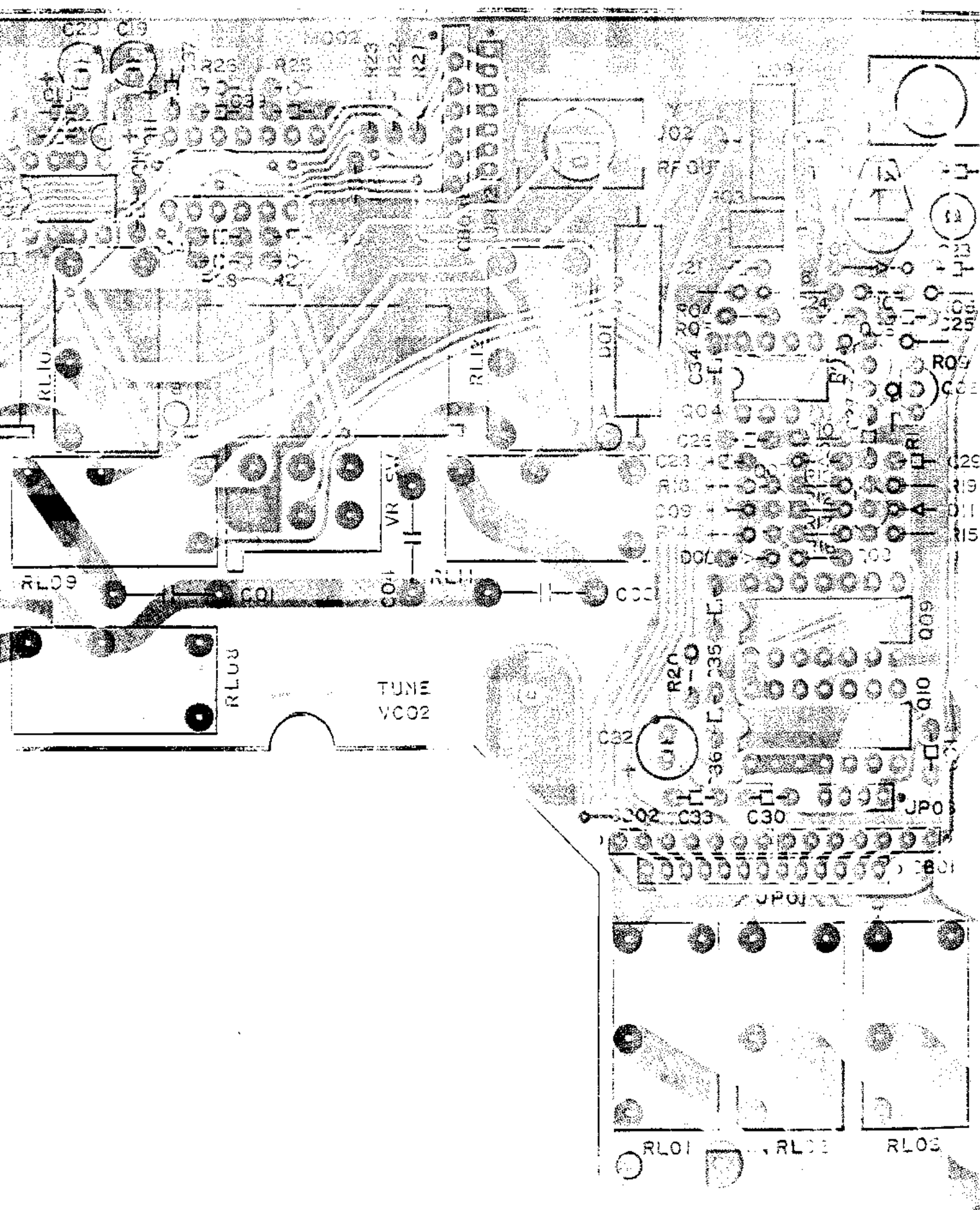

C20 C19

R26 R25 R23 R22 R21

R20 R19 R18 R17 R16 R15 R14

RL10

RL11

D01

C34 C33 C32 C31 C30 C29 C28 C27 C26 C25 C24 C23 C22 C21 C20 C19 C18 C17 C16 C15 C14 C13 C12 C11 C10 C09 C08 C07 C06 C05 C04 C03 C02 C01

VR C04

RL09

RL08

TUNE VC02

R20

C32

C31

C30

C29

C28

C27

C26

C25

C24

C23

C22

C21

C20

C19

C18

C17

C16

C15

C14

C13

C12

C11

C10

C09

C08

C07

C06

C05

C04

C03

C02

C01

RL01

RL02

RL03

F3098101A

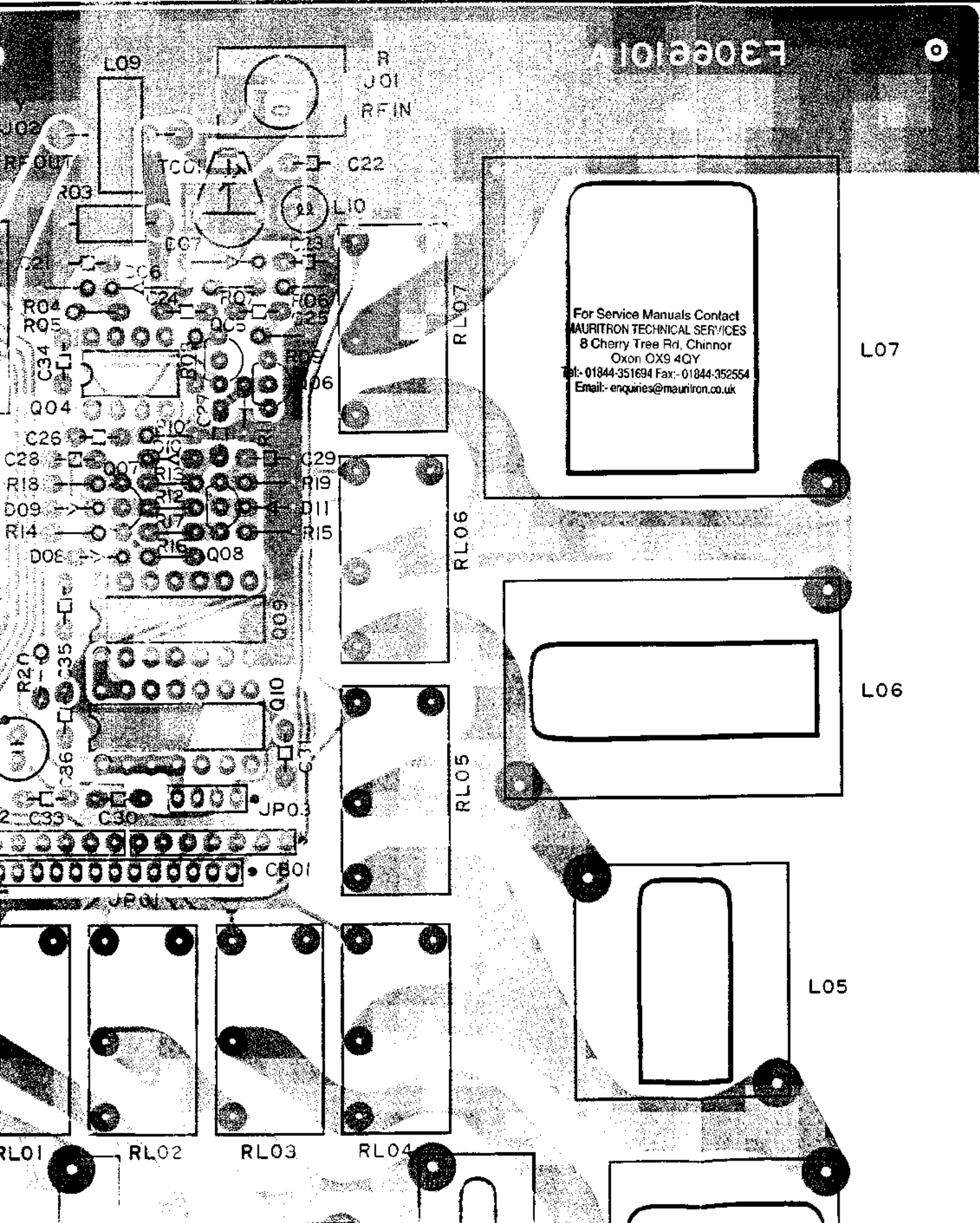

For Service Manuals Contact
MAURITRON TECHNICAL SERVICES
8 Cherry Tree Rd, Chinnor
Oxon OX9 4QY
Tel: 01844-351694 Fax: 01844-352554
Email: enquiries@mauritron.co.uk

L07

L06

L05

RL01 RL02 RL03 RL04

Tuner Main Unit Board Layout

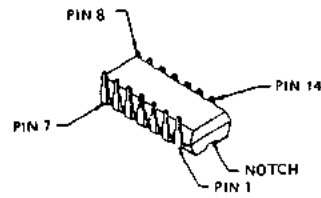
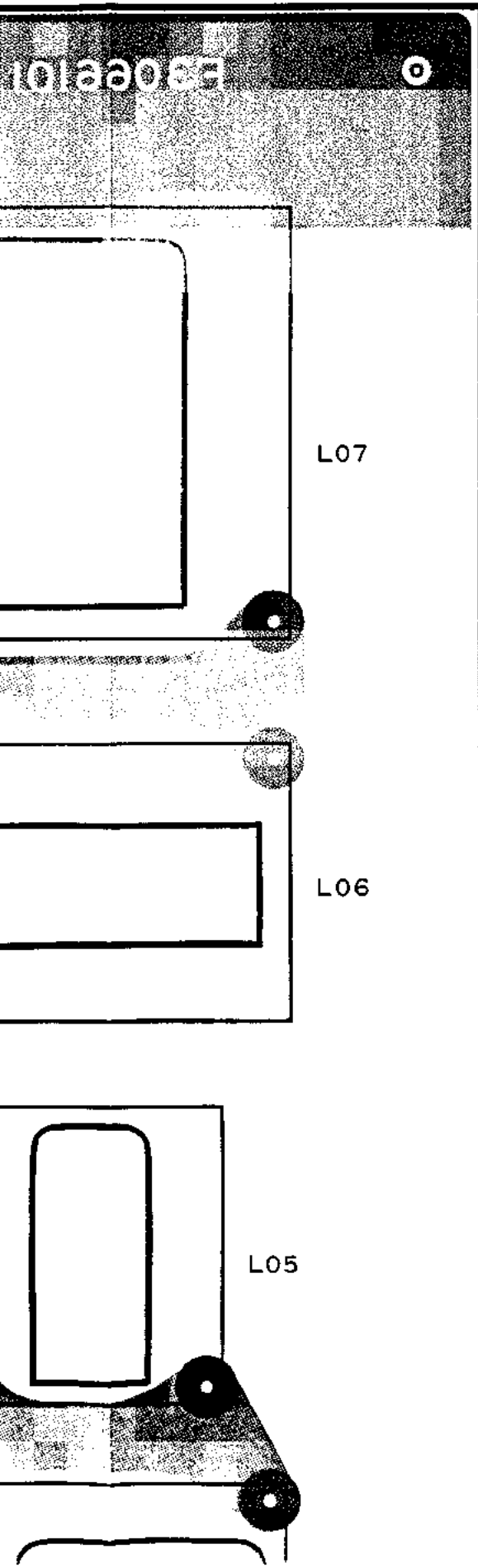

MC14071BCP
(Q7411)
HD74HC74P
(Q7410)
HD74HC00P
(Q7409)

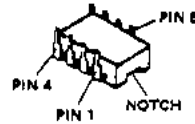

μ PC393C
(Q7404)
MB3763
(Q7402, Q7403)

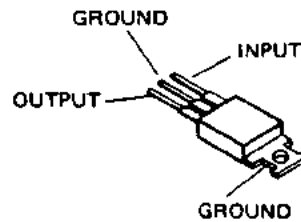

MC7809CT
(Q7401)

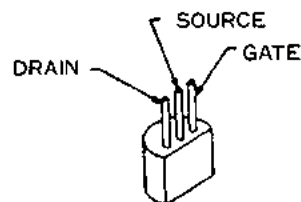

2SK104J
(Q7405, Q7406)

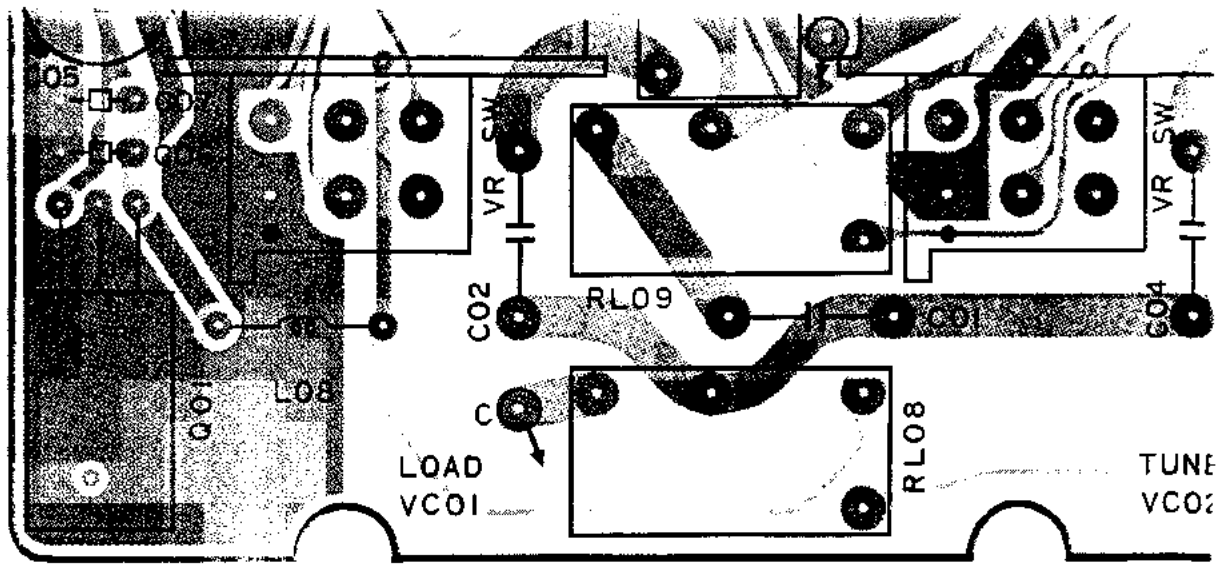

For Service Manuals Contact
MAURITRON TECHNICAL SERVICES
 8 Cherry Tree Rd, Chinnor
 Oxon OX9 4QY
 Tel: 01844-351694 Fax: 01844-352554
 Email: enquires@mauritron.co.uk

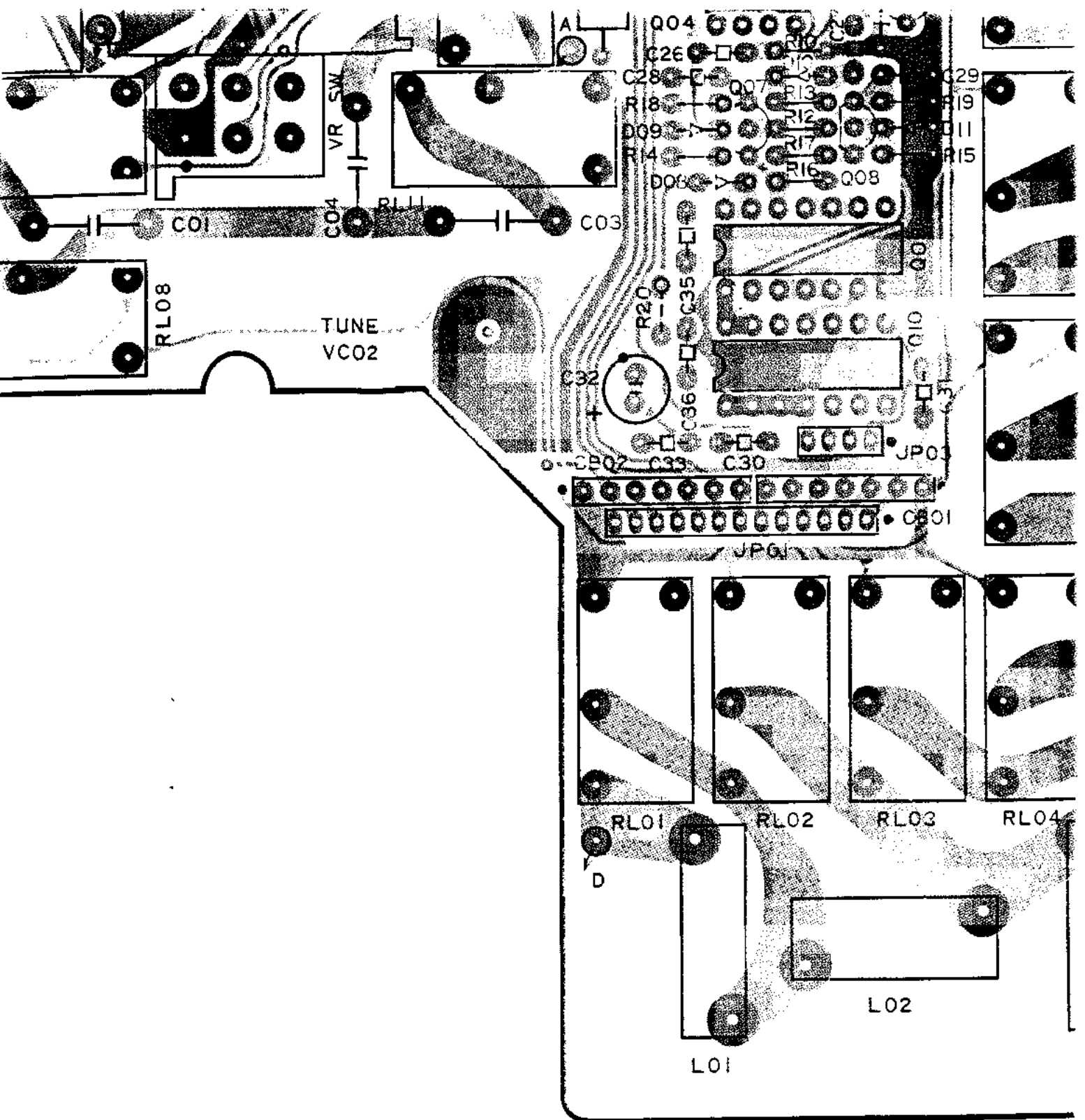

For Service Manuals Contact
MAURITRON TECHNICAL SERVICES
 8 Cherry Tree Rd, Chinnor
 Oxon OX9 4QY
 Tel:- 01844-351694 Fax:- 01844-352554
 Email:- enquiries@mauritron.co.uk

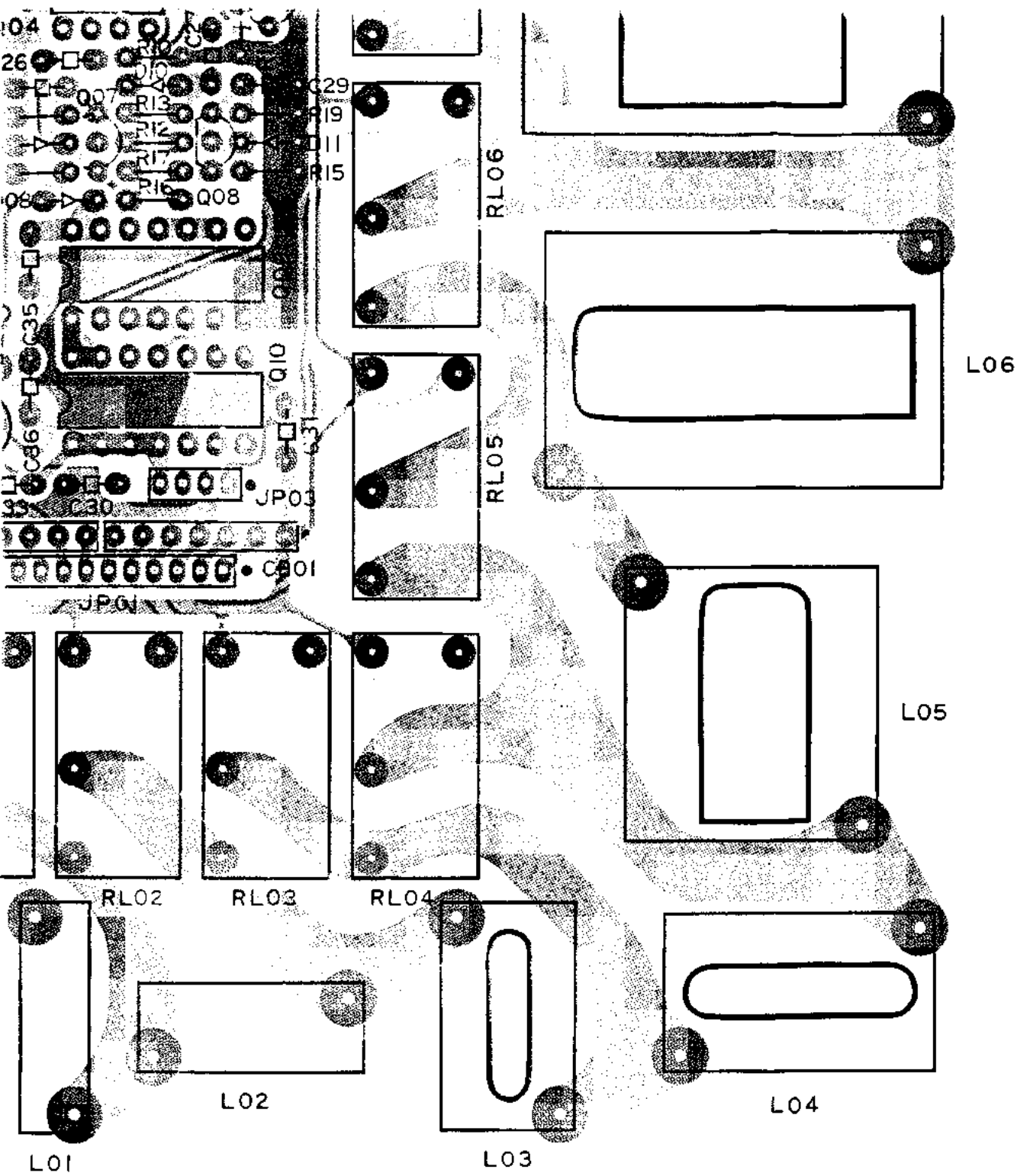

(obverse view of "component" side)

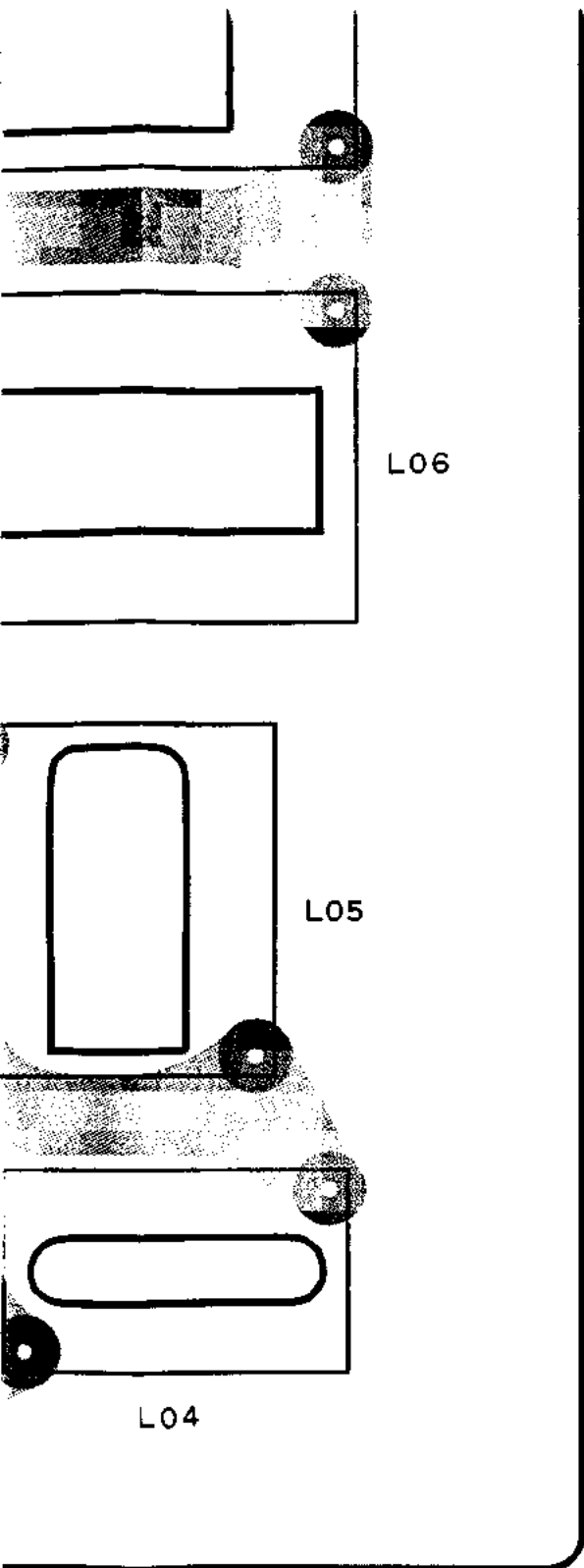

Reverse view of "component" side)



MPC393C
(Q7404)
MB3763
(Q7402, Q7403)

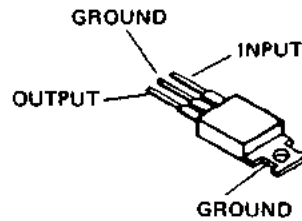

MC7809CT
(Q7401)

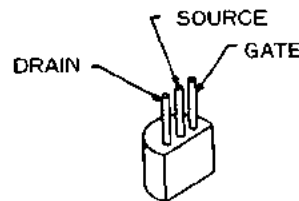

2SK104J
(Q7405, Q7406)

For Service Manuals Contact
MAURITRON TECHNICAL SERVICES
8 Cherry Tree Rd, Chinnor
Oxon OX9 4QY
Tel: 01844-351694 Fax: 01844-352554
Email: enquiries@mauritron.co.uk

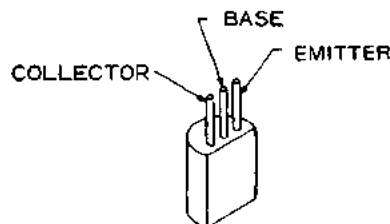

2SC2901L
(Q7407, Q7408)

For Service Manuals Contact
MAURITRON TECHNICAL SERVICES
8 Cherry Tree Rd, Chinnor
Oxon OX9 4QY
Tel: 01844-351694 Fax: 01844-352554
Email: enquiries@mauritron.co.uk

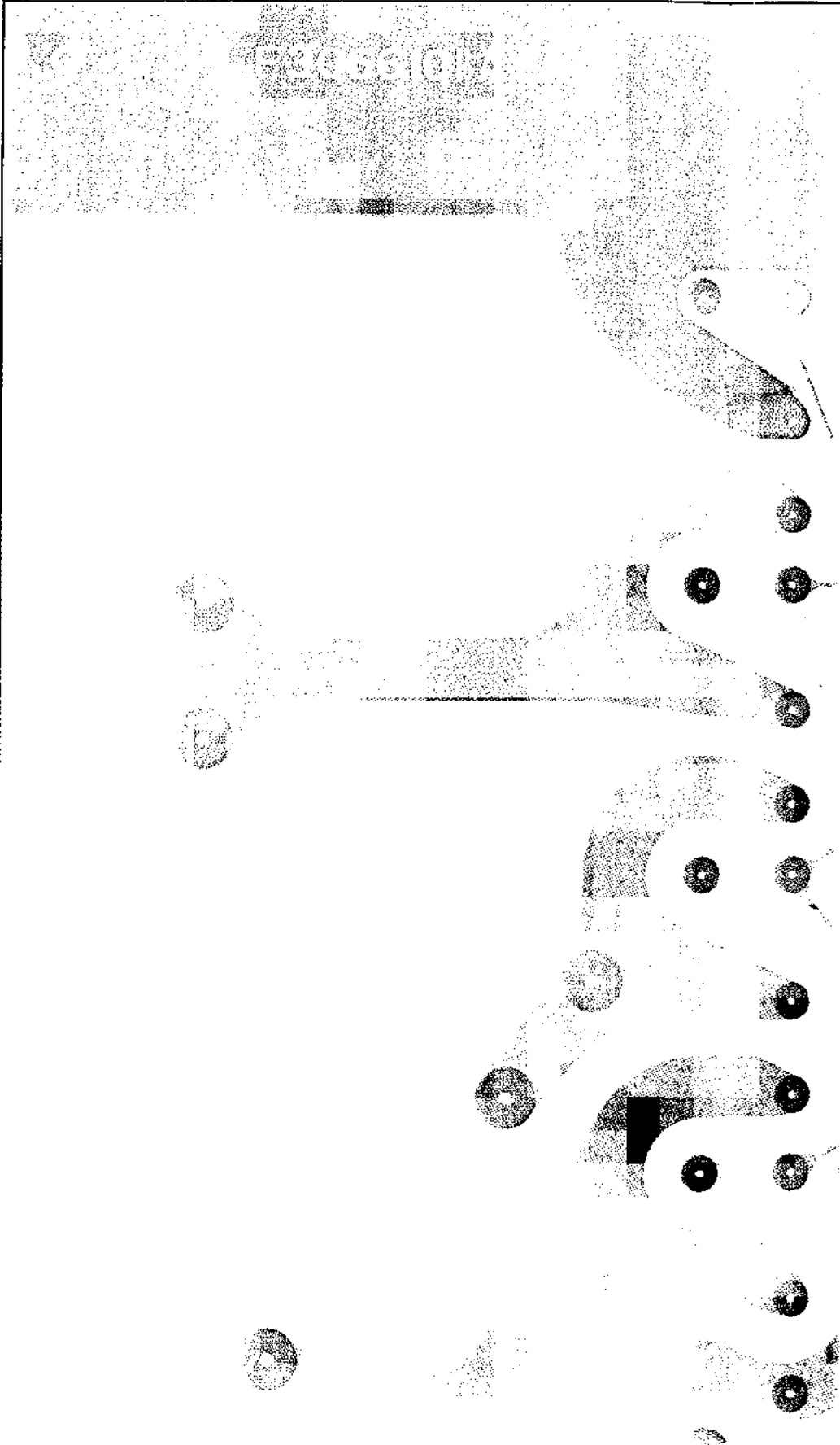

For Service Manuals Contact
MAURITRON TECHNICAL SERVICES
8 Cherry Tree Rd, Chinnor
Oxon OX9 4QY
Tel: 01844-351694 Fax: 01844-352554
Email: enquiries@mauritron.co.uk

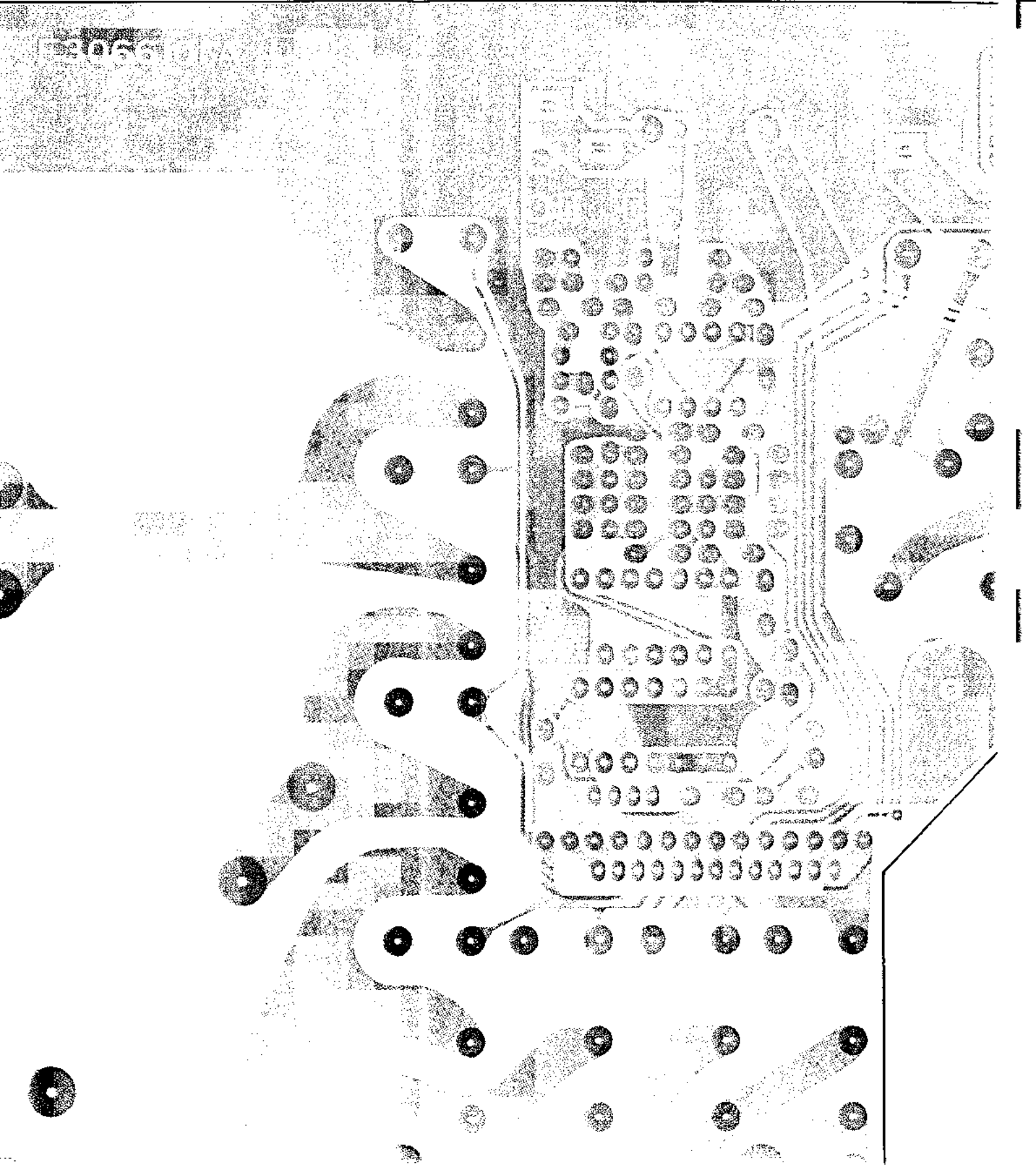

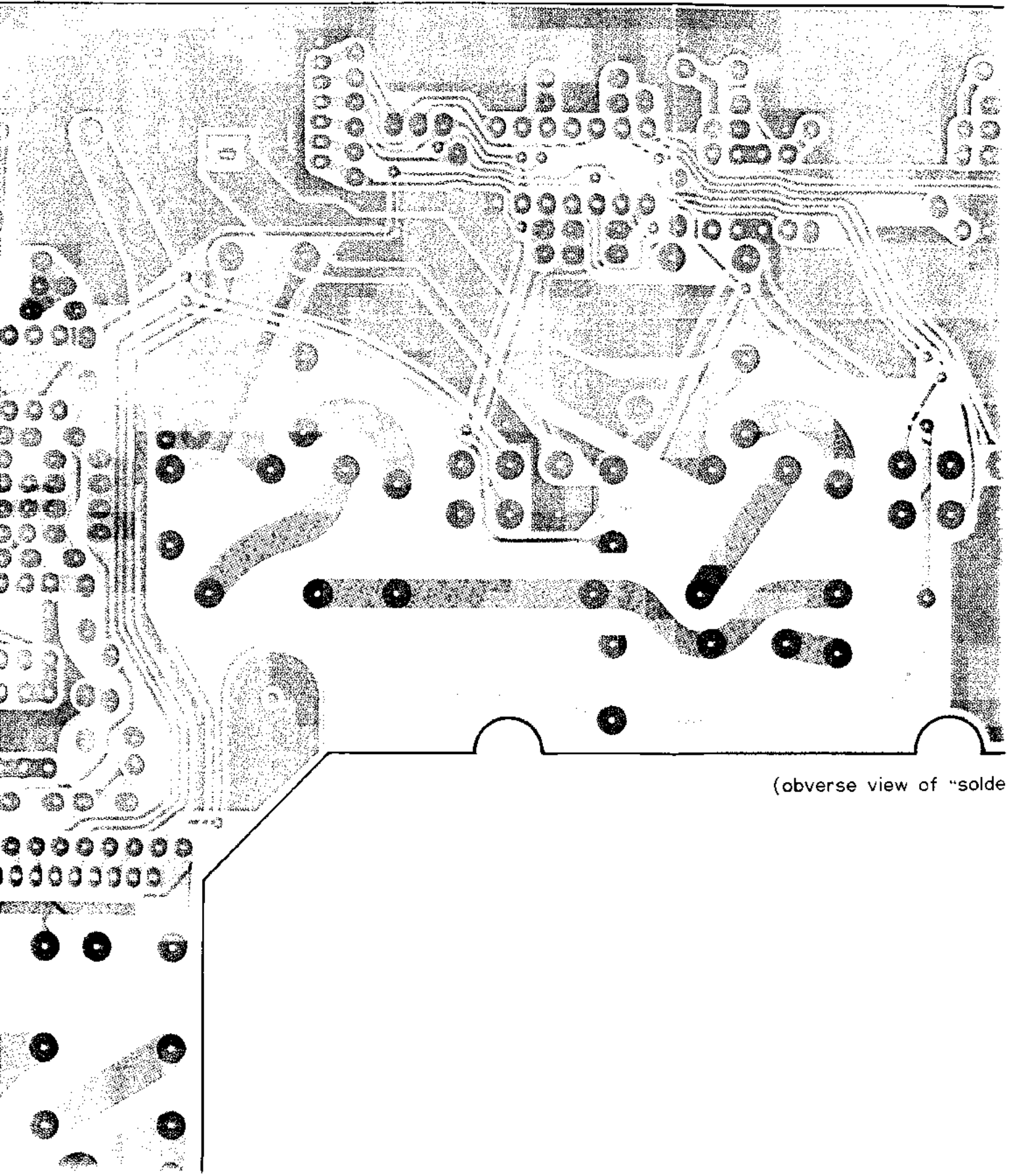

(obverse view of "solde

Tuner Main Unit Board Layout

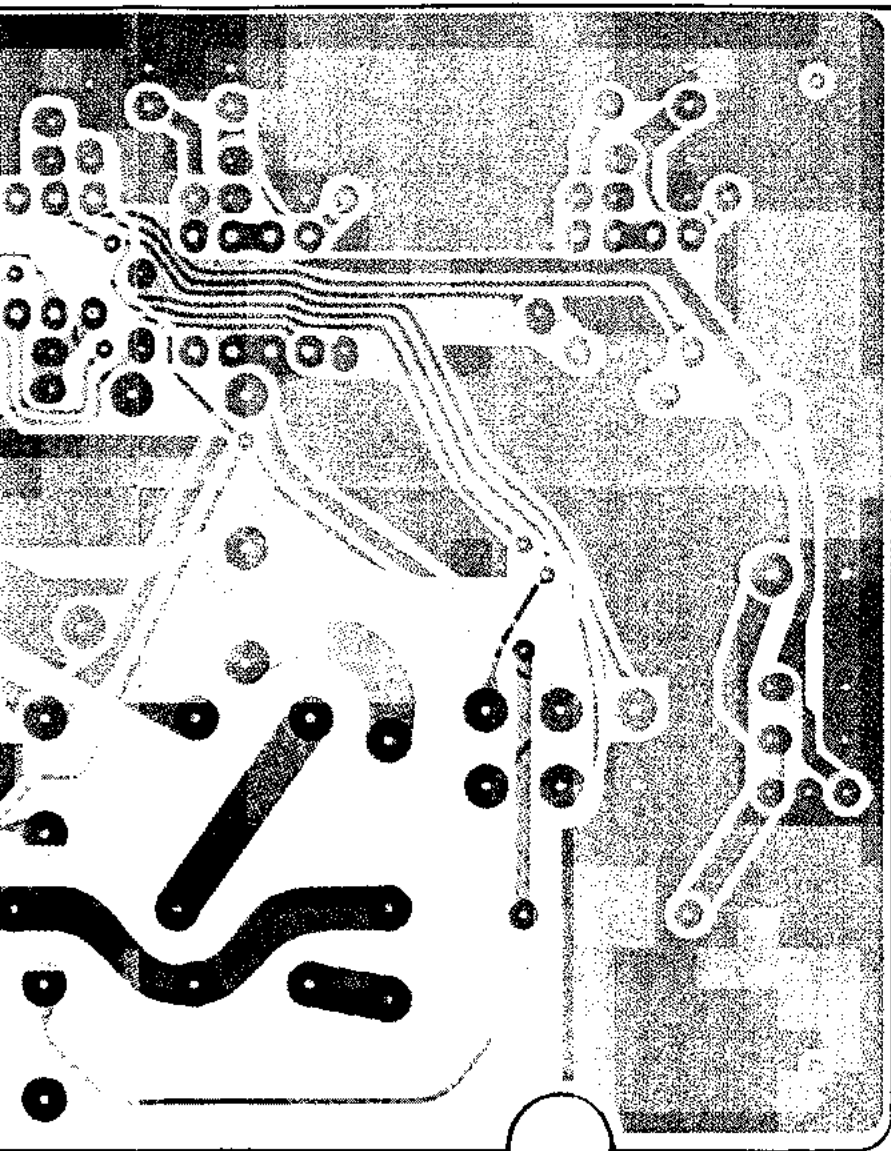

(obverse view of "solder" side)

For Service Manuals Contact
MAURITRON TECHNICAL SERVICES
8 Cherry Tree Rd, Chinnor
Oxon OX9 4QY
Tel: 01844-351694 Fax: 01844-352554
Email: enquiries@mauritron.co.uk

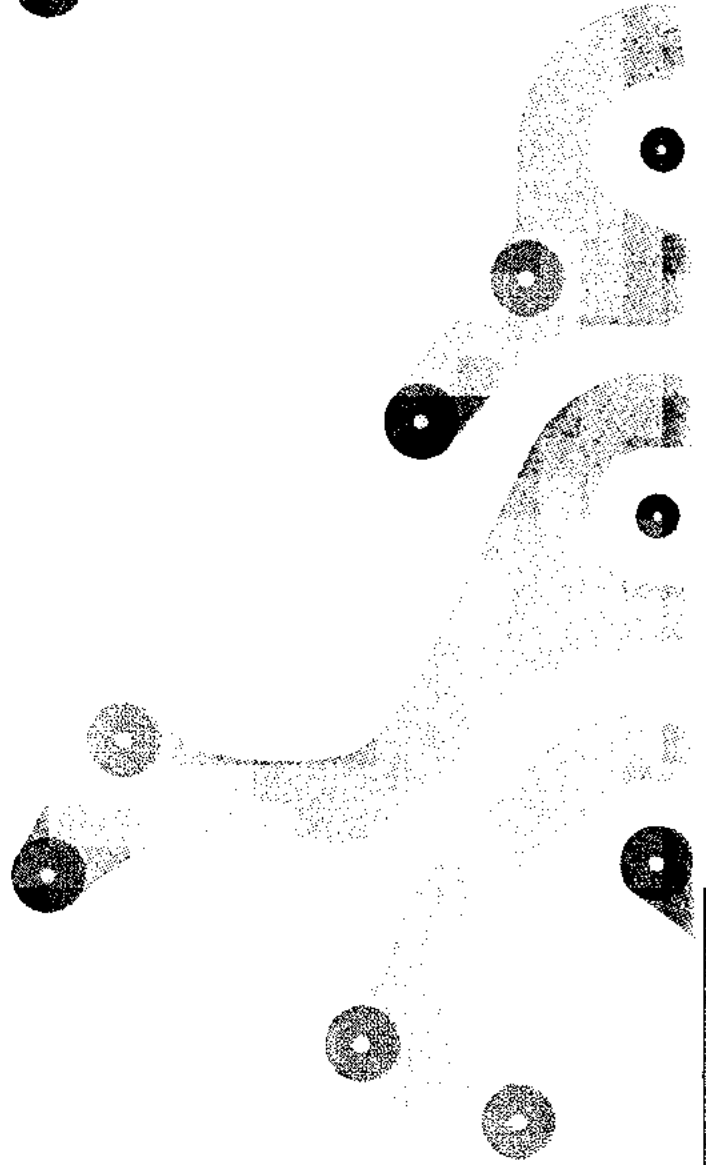
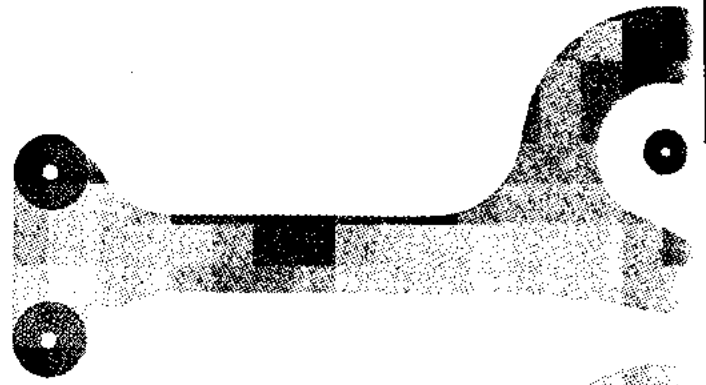

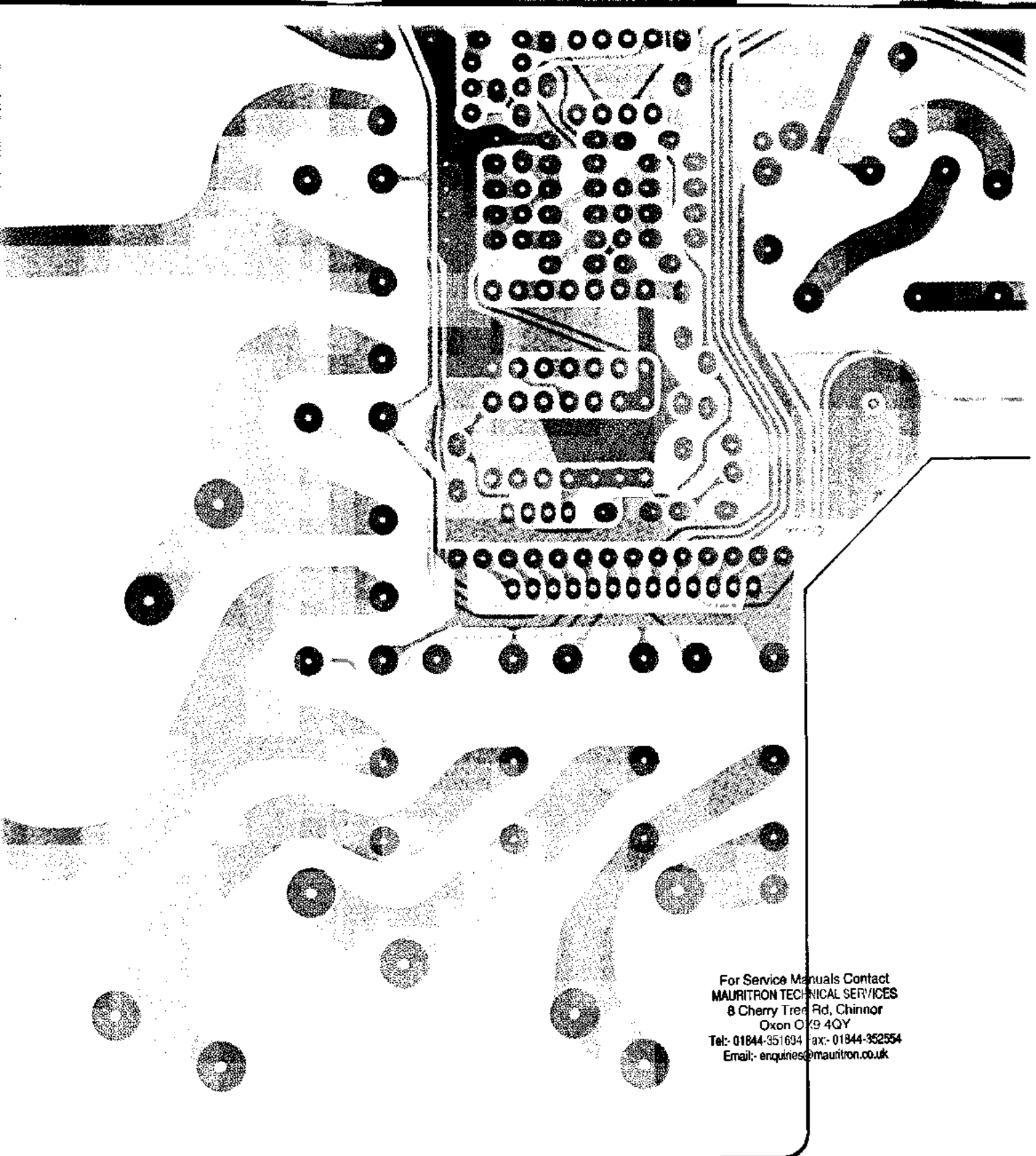

For Service Manuals Contact
MAURITRON TECHNICAL SERVICES
8 Cherry Tree Rd, Chinnor
Oxon OX9 4QY
Tel: 01844-351694 Fax: 01844-352554
Email: enquiries@mauritron.co.uk

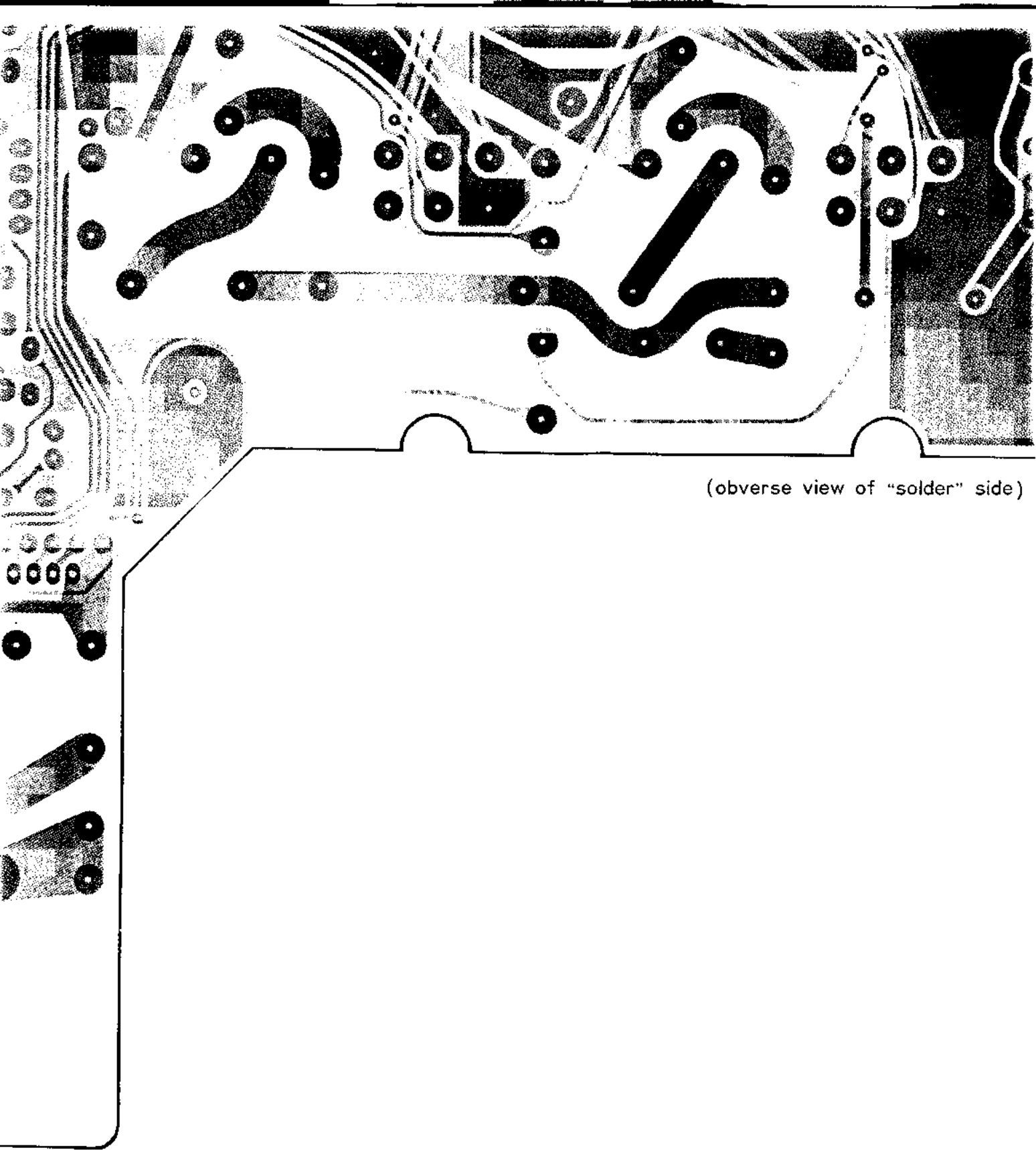

(obverse view of "solder" side)

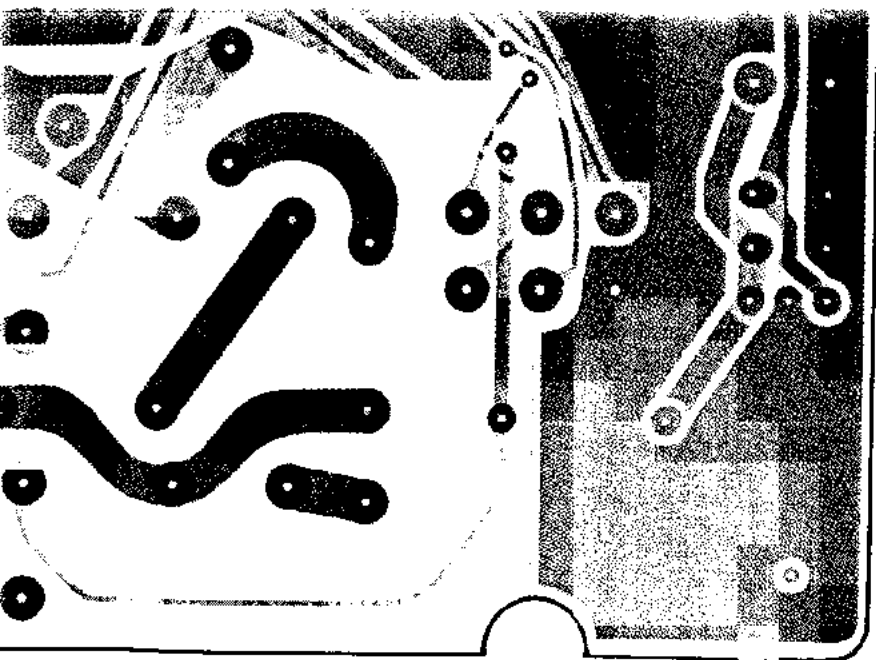

(obverse view of "solder" side)

For Service Manuals Contact
MAURITRON TECHNICAL SERVICES
8 Cherry Tree Rd, Chinnor
Oxon OX9 4QY
Tel: 01844-351694 Fax: 01844-352554
Email: enquiries@mauritron.co.uk

For Service Manuals Contact
MAURITRON TECHNICAL SERVICES
 8 Cherry Tree Rd, Chinnor
 Oxon OX9 4QY
 Tel: 01844-351694 Fax: 01844-352554
 Email: enquiries@mauritron.co.uk

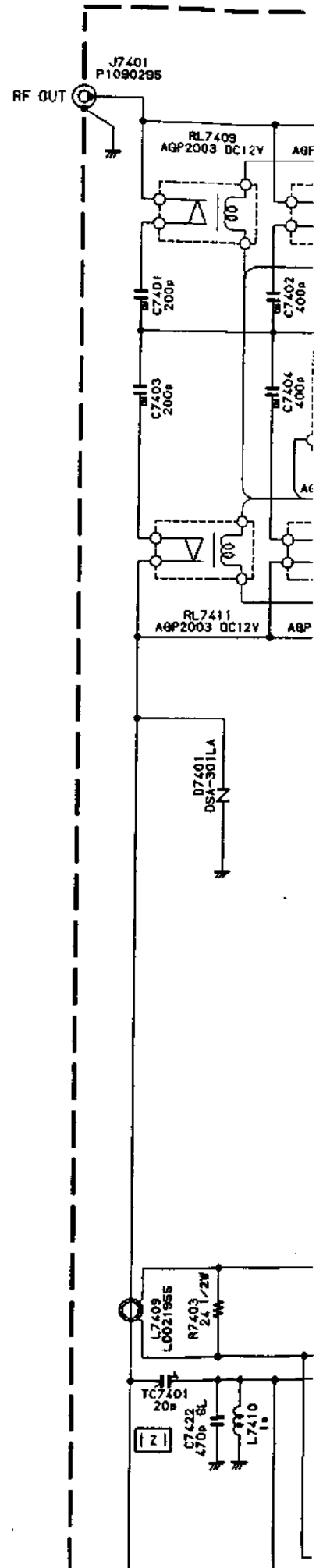

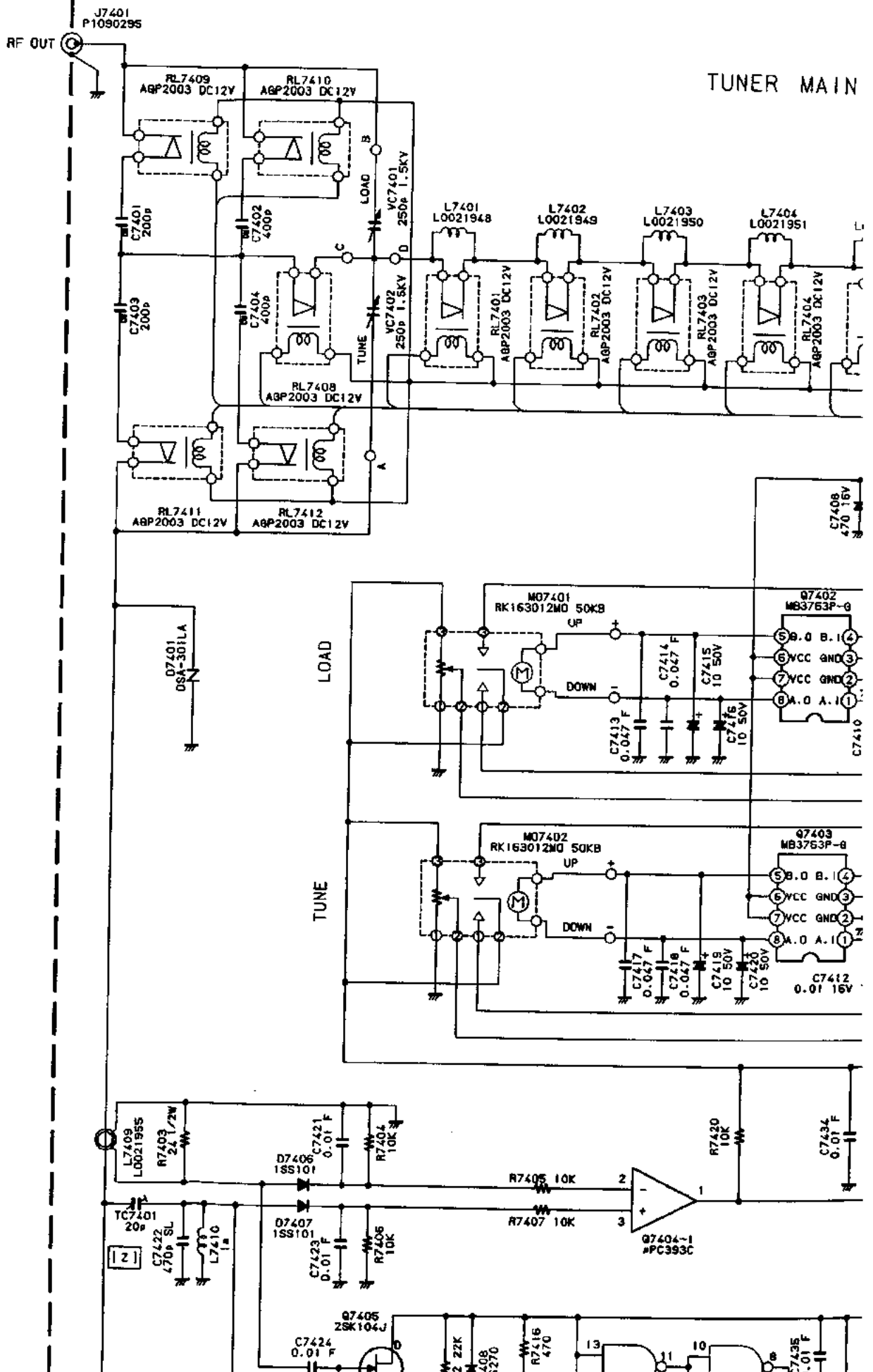

TUNER MAIN UNIT

For Service Manuals Contact
MAURITRON TECHNICAL SERVICES
 8 Cherry Tree Rd, Chinnor
 Oxon OX9 4QY
 Tel: 01844 351894 Fax: 01844 352554
 Email: enquiries@mauritron.co.uk

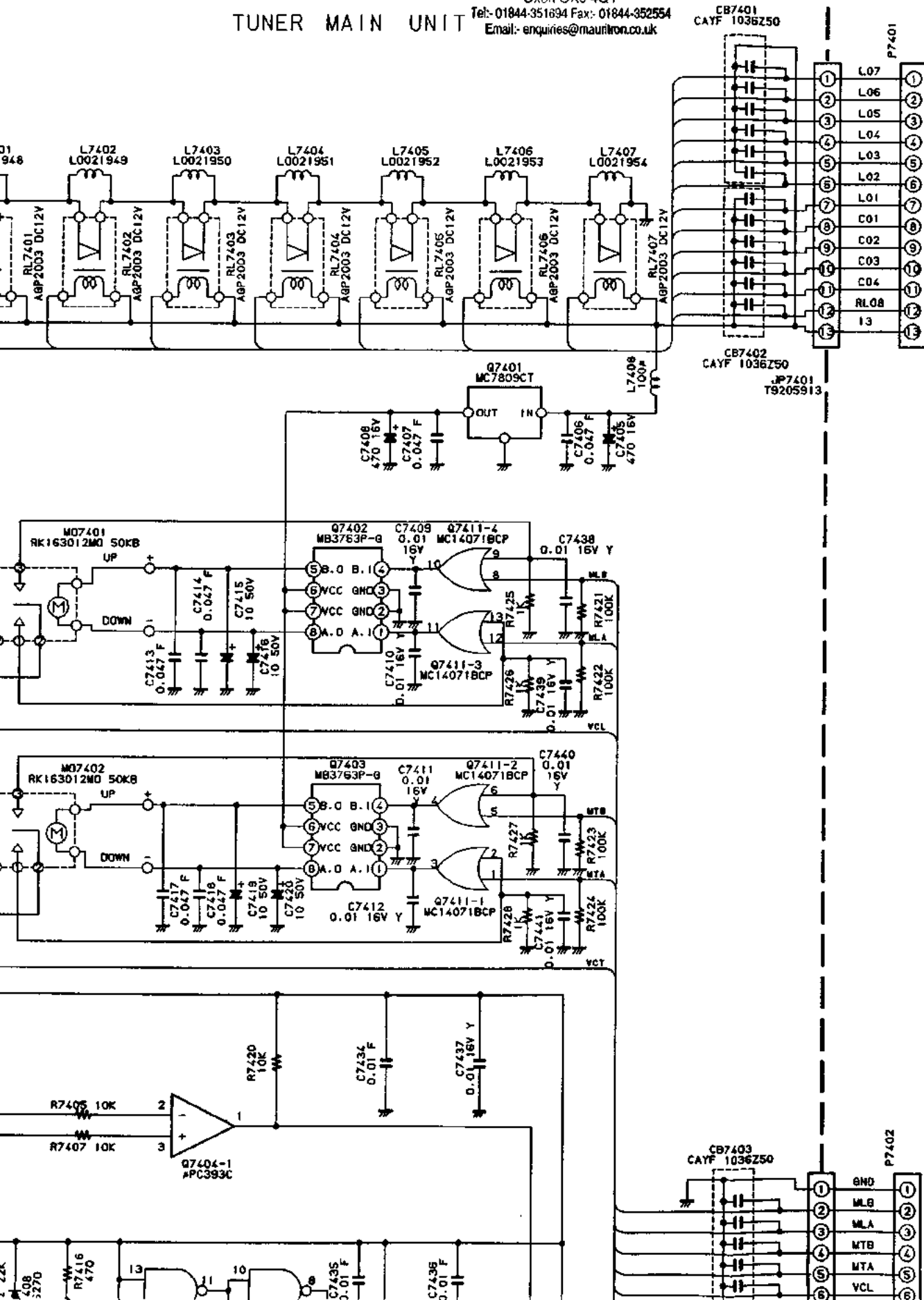

Tuner Main Unit Schematic Diagram

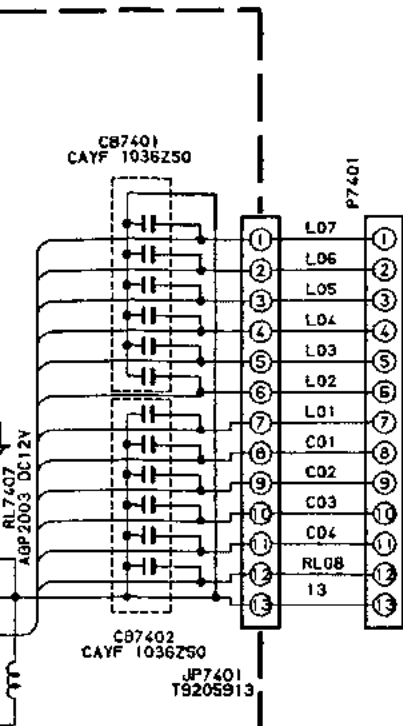

For Service Manuals Contact
MAURITRON TECHNICAL SERVICES
 8 Cherry Tree Rd, Chinnor
 Oxon OX9 4QY
 Tel:- 01844-351694 Fax:- 01844-352564
 Email:- enquiries@mauritron.co.uk

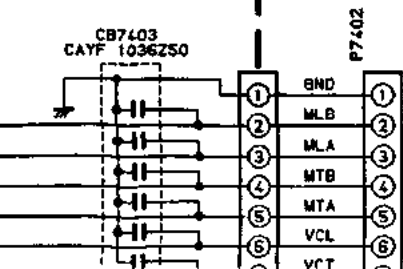

07401
09A-301LA

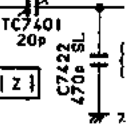

RF IN  J7402
P1090295

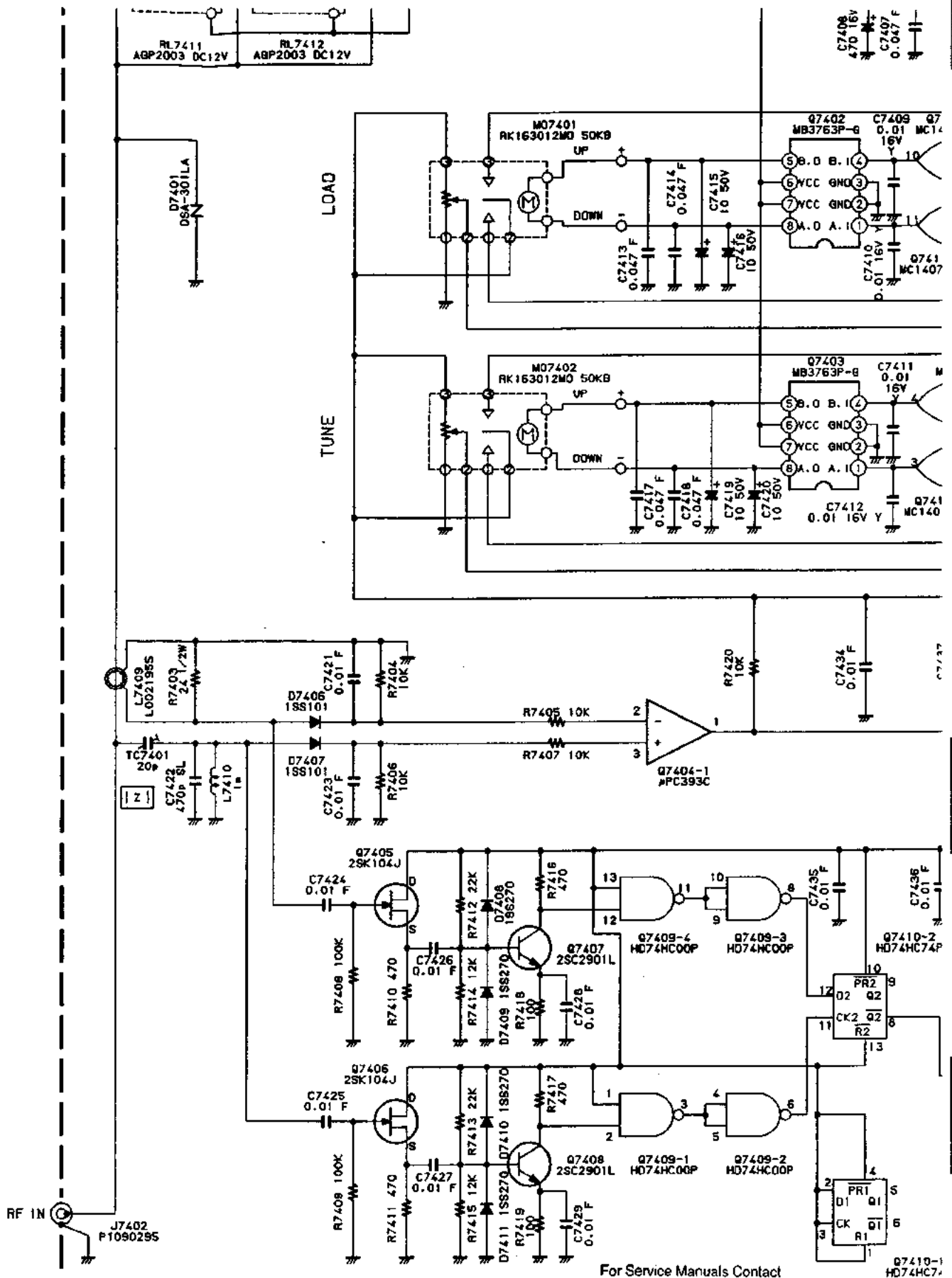

NOTE:
 RESISTOR VALUES ARE IN Ω, 1/4W ;
 0W CAPACITORS ARE DIPPED MICA IN F.
 CAPACITOR VALUES ARE IN nF, 50V ;
 INDUCTOR VALUES ARE IN H ;
 UNLESS OTHERWISE NOTED.

For Service Manuals Contact
MAURITRON TECHNICAL SERVICES
 8 Cherry Tree Rd, Chinnor
 Oxon OX9 4QY
 Tel: 01844-351654 fax: 01844-352554
 Email: enquiries@mauritron.co.uk

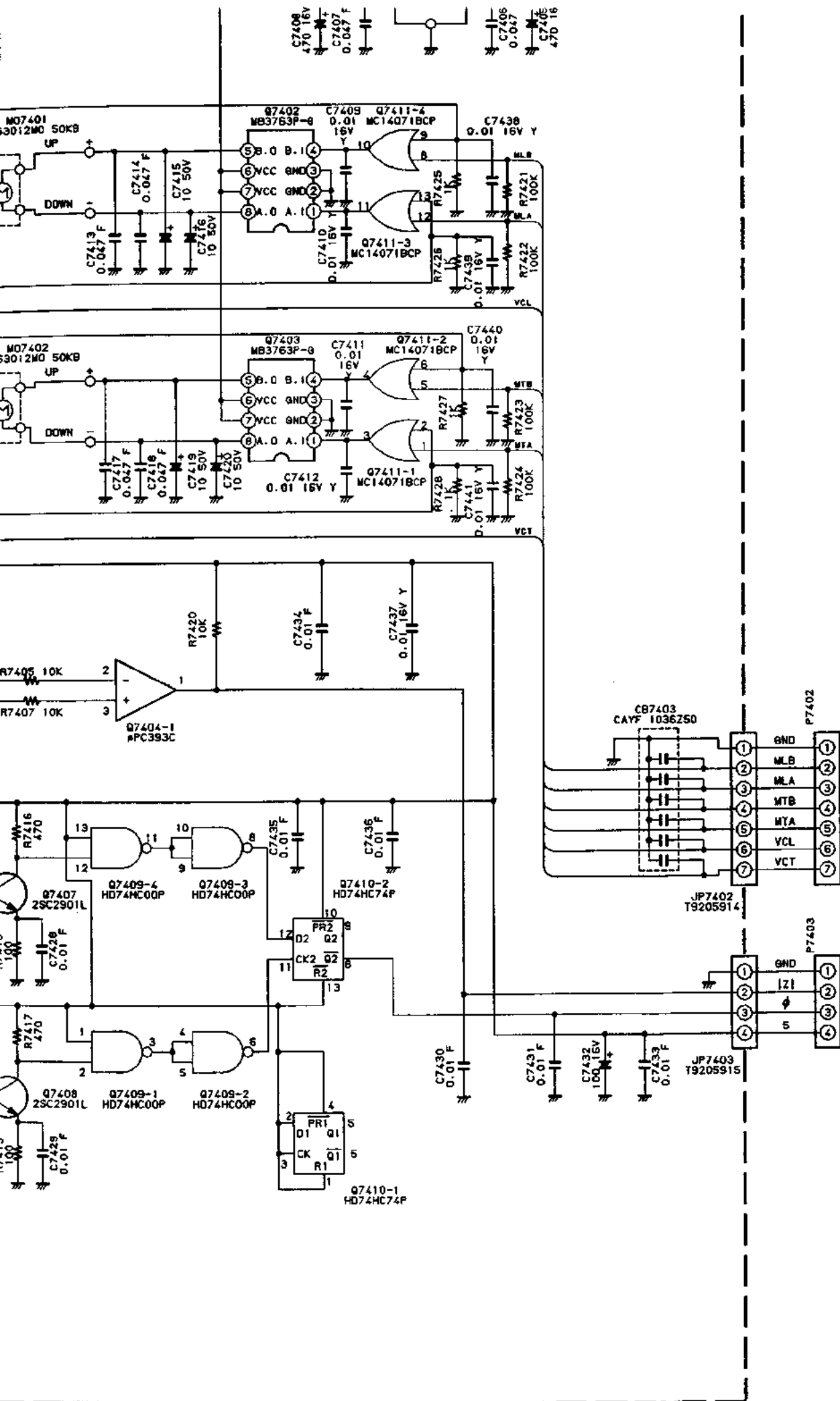

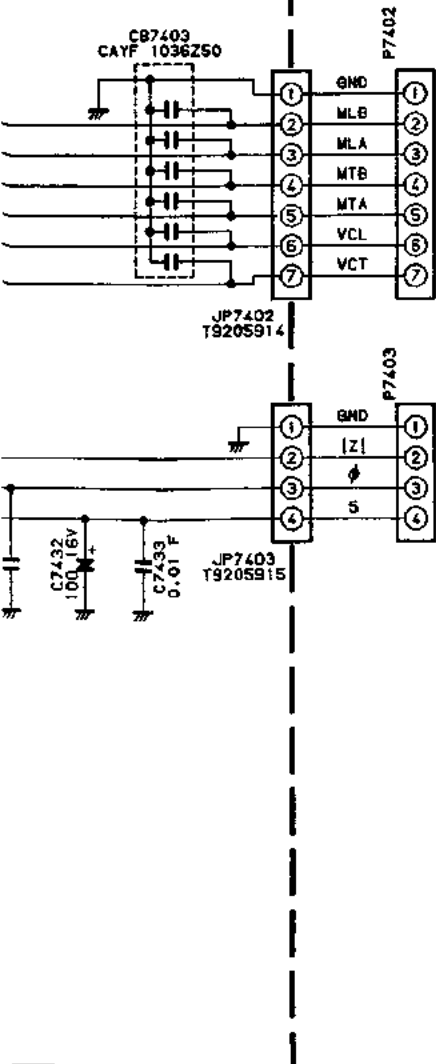

For Service Manuals Contact
MAURITRON TECHNICAL SERVICES
 8 Cherry Tree Rd, Chinnor
 Oxon OX9 4QY
 Tel:- 01844-351694 Fax:- 01844-352554
 Email- enquiries@mauritron.co.uk

Tuner Control Unit Parts List

ADD	CODE NO	DESCRIPTION	DEVICE	TYP	VAL
** UNIT NAME : TUNER-CNTL					
C	7501	K26170079 CERAMIC CAP.	DD104-289SL330J50	33pF	50V SL
C	7502	K26170079 CERAMIC CAP.	DD104-289SL330J50	33pF	50V SL
C	7503	K28129001 CERAMIC CAP.	EP050Y103N-A	0.01uF	16V Y
C	7504	K28129001 CERAMIC CAP.	EP050Y103N-A	0.01uF	16V Y
C	7505	K28129001 CERAMIC CAP.	EP050Y103N-A	0.01uF	16V Y
C	7506	K28129001 CERAMIC CAP.	EP050Y103N-A	0.01uF	16V Y
C	7507	K28129001 CERAMIC CAP.	EP050Y103N-A	0.01uF	16V Y
C	7508	K28129001 CERAMIC CAP.	EP050Y103N-A	0.01uF	16V Y
C	7509	K28129001 CERAMIC CAP.	EP050Y103N-A	0.01uF	16V Y
C	7510	K28129001 CERAMIC CAP.	EP050Y103N-A	0.01uF	16V Y
C	7511	K28129001 CERAMIC CAP.	EP050Y103N-A	0.01uF	16V Y
C	7512	K28129001 CERAMIC CAP.	EP050Y103N-A	0.01uF	16V Y
C	7513	K28129001 CERAMIC CAP.	EP050Y103N-A	0.01uF	16V Y
C	7514	K28129001 CERAMIC CAP.	EP050Y103N-A	0.01uF	16V Y
C	7515	K28129001 CERAMIC CAP.	EP050Y103N-A	0.01uF	16V Y
C	7516	K46170031 AL. ELECTRO. CAP.	50V2R2M4X7TR2	2.2uF	50V
C	7517	K46120007 AL. ELECTRO. CAP.	16V101M6X7TR2	100uF	16V
C	7518	K28129001 CERAMIC CAP.	EP050Y103N-A	0.01uF	16V Y
C	7519	K28129001 CERAMIC CAP.	EP050Y103N-A	0.01uF	16V Y
C	7520	K46120007 AL. ELECTRO. CAP.	16V101M6X7TR2	100uF	16V
C	7521	K28129001 CERAMIC CAP.	EP050Y103N-A	0.01uF	16V Y
C	7522	K28129001 CERAMIC CAP.	EP050Y103N-A	0.01uF	16V Y
C	7523	K28179002 CERAMIC CAP.	UP050F473Z-A-B	0.047uF	50V F
C	7524	K46120007 AL. ELECTRO. CAP.	16V101M6X7TR2	100uF	16V
C	7525	K28129001 CERAMIC CAP.	EP050Y103N-A	0.01uF	16V Y
C	7526	K28129001 CERAMIC CAP.	EP050Y103N-A	0.01uF	16V Y
C	7527	K28129001 CERAMIC CAP.	EP050Y103N-A	0.01uF	16V Y
C	7528	K28129001 CERAMIC CAP.	EP050Y103N-A	0.01uF	16V Y
C	7529	K28129001 CERAMIC CAP.	EP050Y103N-A	0.01uF	16V Y
C	7530	K28129001 CERAMIC CAP.	EP050Y103N-A	0.01uF	16V Y
C	7531	K28129001 CERAMIC CAP.	EP050Y103N-A	0.01uF	16V Y
C	7532	K28129001 CERAMIC CAP.	EP050Y103N-A	0.01uF	16V Y
C	7533	K28129001 CERAMIC CAP.	EP050Y103N-A	0.01uF	16V Y
C	7534	K28129001 CERAMIC CAP.	EP050Y103N-A	0.01uF	16V Y
C	7536	K28179002 CERAMIC CAP.	UP050F473Z-A-B	0.047uF	50V F
C	7537	K28179002 CERAMIC CAP.	UP050F473Z-A-B	0.047uF	50V F
C	7538	K28179002 CERAMIC CAP.	UP050F473Z-A-B	0.047uF	50V F
C	7539	K70167105 TANTALUM CAP.	DN1V010M1S	1uF	35V
C	7540	K70167105 TANTALUM CAP.	DN1V010M1S	1uF	35V
C	7541	K28129001 CERAMIC CAP.	EP050Y103N-A	0.01uF	16V Y
C	7542	K28129001 CERAMIC CAP.	EP050Y103N-A	0.01uF	16V Y
C	7543	K28129001 CERAMIC CAP.	EP050Y103N-A	0.01uF	16V Y
C	7544	K28129001 CERAMIC CAP.	EP050Y103N-A	0.01uF	16V Y
C	7545	K28129001 CERAMIC CAP.	EP050Y103N-A	0.01uF	16V Y
C	7546	K46120007 AL. ELECTRO. CAP.	16V101M6X7TR2	100uF	16V
C	7547	K46120007 AL. ELECTRO. CAP.	16V101M6X7TR2	100uF	16V
C	7548	K28129001 CERAMIC CAP.	EP050Y103N-A	0.01uF	16V Y
C	7549	K28129001 CERAMIC CAP.	EP050Y103N-A	0.01uF	16V Y
C	7550	K28129001 CERAMIC CAP.	EP050Y103N-A	0.01uF	16V Y
C	7551	K28129001 CERAMIC CAP.	EP050Y103N-A	0.01uF	16V Y
C	7552	K28129001 CERAMIC CAP.	EP050Y103N-A	0.01uF	16V Y
C	7553	K28129001 CERAMIC CAP.	EP050Y103N-A	0.01uF	16V Y
C	7554	K28129001 CERAMIC CAP.	EP050Y103N-A	0.01uF	16V Y
C	7555	K28129001 CERAMIC CAP.	EP050Y103N-A	0.01uF	16V Y
C	7556	K28129001 CERAMIC CAP.	EP050Y103N-A	0.01uF	16V Y
C	7557	K46120005 AL. ELECTRO. CAP.	16V220M5X7TR2	22uF	16V
C	7558	K46120007 AL. ELECTRO. CAP.	16V101M6X7TR2	100uF	16V
C	7559	K28129001 CERAMIC CAP.	EP050Y103N-A	0.01uF	16V Y
C	7565	K28129001 CERAMIC CAP.	EP050Y103N-A	0.01uF	16V Y
C	7566	K28129001 CERAMIC CAP.	EP050Y103N-A	0.01uF	16V Y
C	7567	K28129001 CERAMIC CAP.	EP050Y103N-A	0.01uF	16V Y
C	7568	K28129001 CERAMIC CAP.	EP050Y103N-A	0.01uF	16V Y
C	7569	K28129001 CERAMIC CAP.	EP050Y103N-A	0.01uF	16V Y
C	7570	K28129001 CERAMIC CAP.	EP050Y103N-A	0.01uF	16V Y
C	7571	K28129001 CERAMIC CAP.	EP050Y103N-A	0.01uF	16V Y
C	7501	H7900580 CERAMIC OSC	CSA8.00MT		
D	7501	G2090118 DIODE	1SS97		
D	7502	G2060004 DIODE	1SS270TJ		
D	7503	G2060004 DIODE	1SS270TJ		
D	7504	G2060004 DIODE	1SS270TJ		
D	7509	G2060004 DIODE	1SS270TJ		
D	7510	G2060004 DIODE	1SS270TJ		
D	7511	G2060004 DIODE	1SS270TJ		
D	7512	G2060004 DIODE	1SS270TJ		
D	7513	G2060004 DIODE	1SS270TJ		
D	7514	G2090118 DIODE	1SS97		
J	7501	P0090632 CONNECTOR	SC25-13WS		
J	7502	P0090626 CONNECTOR	SC25-07WS		
J	7503	P0090623 CONNECTOR	SC25-04WS		
J	7504	P0090623 CONNECTOR	SC25-04WS		
J	7505	P0090624 CONNECTOR	SC25-05WS		
J	7506	P0090631 CONNECTOR	SC25-12WS		

Tuner Control Unit Parts List

ADD	CODE NO	DESCRIPTION	DEVICE	TYP	VAL
L 7501	L1790095	M. RFC	LAL03TA100K	10uH	
Q 7501	G1090992	IC	M37450E4-***FP		
Q 7502	G1090554	IC	UPA2003C		
Q 7503	G1090554	IC	UPA2003C		
Q 7504	G1090848	IC	UPC78L05J		
Q 7505	G1090848	IC	UPC78L05J		
Q 7506	G3304584B	TRANSISTOR	2SC458BTZ		
Q 7507	G3304584B	TRANSISTOR	2SC458BTZ		
Q 7508	G1090536	IC	UPC393C		
Q 7509	G1090588	IC	UPC358C		
Q 7510	G1090230	IC	UPC324C		
Q 7511	G3801040J	FET	2SK104J		
Q 7512	G3801040J	FET	2SK104J		
Q 7513	G1090297	IC	UPD4094BC		
Q 7514	G1090297	IC	UPD4094BC		
Q 7515	G3304584B	TRANSISTOR	2SC458BTZ		
Q 7516	G3304584B	TRANSISTOR	2SC458BTZ		
R 7501	J07225105	CARBON FILM RES.	RD16TPJ105	1M	1M
R 7502	J07225104	CARBON FILM RES.	RD16TPJ104	100K	100K
R 7503	J07225104	CARBON FILM RES.	RD16TPJ104	100K	100K
R 7504	J07225104	CARBON FILM RES.	RD16TPJ104	100K	100K
R 7505	J07225104	CARBON FILM RES.	RD16TPJ104	100K	100K
R 7506	J07225104	CARBON FILM RES.	RD16TPJ104	100K	100K
R 7507	J07225104	CARBON FILM RES.	RD16TPJ104	100K	100K
R 7508	J07225104	CARBON FILM RES.	RD16TPJ104	100K	100K
R 7509	J07225104	CARBON FILM RES.	RD16TPJ104	100K	100K
R 7510	J07225104	CARBON FILM RES.	RD16TPJ104	100K	100K
R 7511	J07225104	CARBON FILM RES.	RD16TPJ104	100K	100K
R 7512	J07225103	CARBON FILM RES.	RD16TPJ103	10K	10K
R 7513	J07225470	CARBON FILM RES.	RD16TPJ470	47	47
R 7514	J07225393	CARBON FILM RES.	RD16TPJ393	39K	39K
R 7515	J07225273	CARBON FILM RES.	RD16TPJ273	27K	27K
R 7516	J07225104	CARBON FILM RES.	RD16TPJ104	100K	100K
R 7517	J07225104	CARBON FILM RES.	RD16TPJ104	100K	100K
R 7518	J07225104	CARBON FILM RES.	RD16TPJ104	100K	100K
R 7519	J07225104	CARBON FILM RES.	RD16TPJ104	100K	100K
R 7520	J07225474	CARBON FILM RES.	RD16TPJ474	470K	470K
R 7521	J07225474	CARBON FILM RES.	RD16TPJ474	470K	470K
R 7523	J07225104	CARBON FILM RES.	RD16TPJ104	100K	100K
R 7524	J07225104	CARBON FILM RES.	RD16TPJ104	100K	100K
R 7525	J07225223	CARBON FILM RES.	RD16TPJ223	22K	22K
R 7526	J07225103	CARBON FILM RES.	RD16TPJ103	10K	10K
R 7527	J07225104	CARBON FILM RES.	RD16TPJ104	100K	100K
R 7528	J07225473	CARBON FILM RES.	RD16TPJ473	47K	47K
R 7529	J07225473	CARBON FILM RES.	RD16TPJ473	47K	47K
R 7530	J07225472	CARBON FILM RES.	RD16TPJ472	4.7K	4.7K
R 7531	J07225103	CARBON FILM RES.	RD16TPJ103	10K	10K
R 7532	J07225104	CARBON FILM RES.	RD16TPJ104	100K	100K
R 7533	J07225224	CARBON FILM RES.	RD16TPJ224	220K	220K
R 7534	J07225105	CARBON FILM RES.	RD16TPJ105	1M	1M
R 7535	J07225105	CARBON FILM RES.	RD16TPJ105	1M	1M
R 7536	J07225822	CARBON FILM RES.	RD16TPJ822	8.2K	8.2K
R 7537	J07225103	CARBON FILM RES.	RD16TPJ103	10K	10K
R 7538	J07225223	CARBON FILM RES.	RD16TPJ223	22K	22K
R 7539	J07225102	CARBON FILM RES.	RD16TPJ102	1K	1K
R 7541	J07225103	CARBON FILM RES.	RD16TPJ103	10K	10K
R 7542	J07225473	CARBON FILM RES.	RD16TPJ473	47K	47K
R 7543	J07225472	CARBON FILM RES.	RD16TPJ472	4.7K	4.7K
R 7544	J07225103	CARBON FILM RES.	RD16TPJ103	10K	10K
R 7545	J07225104	CARBON FILM RES.	RD16TPJ104	100K	100K
R 7546	J07225224	CARBON FILM RES.	RD16TPJ224	220K	220K
R 7547	J07225105	CARBON FILM RES.	RD16TPJ105	1M	1M
R 7548	J07225105	CARBON FILM RES.	RD16TPJ105	1M	1M
R 7549	J07225225	CARBON FILM RES.	RD16TPJ225	2.2M	2.2M
R 7550	J07225103	CARBON FILM RES.	RD16TPJ103	10K	10K
R 7551	J07225103	CARBON FILM RES.	RD16TPJ103	10K	10K
R 7552	J07225102	CARBON FILM RES.	RD16TPJ102	1K	1K
R 7553	J07225473	CARBON FILM RES.	RD16TPJ473	47K	47K
R 7554	J07225102	CARBON FILM RES.	RD16TPJ102	1K	1K
R 7555	J07225474	CARBON FILM RES.	RD16TPJ474	470K	470K
R 7556	J07225225	CARBON FILM RES.	RD16TPJ225	2.2M	2.2M
R 7557	J07225103	CARBON FILM RES.	RD16TPJ103	10K	10K
R 7558	J07225473	CARBON FILM RES.	RD16TPJ473	47K	47K
R 7559	J07225123	CARBON FILM RES.	RD16TPJ123	12K	12K
R 7560	J07225123	CARBON FILM RES.	RD16TPJ123	12K	12K
R 7561	J07225473	CARBON FILM RES.	RD16TPJ473	47K	47K
R 7562	J07225103	CARBON FILM RES.	RD16TPJ103	10K	10K
R 7563	J07225103	CARBON FILM RES.	RD16TPJ103	10K	10K
R 7564	J07225473	CARBON FILM RES.	RD16TPJ473	47K	47K
R 7565	J07225103	CARBON FILM RES.	RD16TPJ103	10K	10K
R 7566	J07225103	CARBON FILM RES.	RD16TPJ103	10K	10K
R 7567	J07225472	CARBON FILM RES.	RD16TPJ472	4.7K	4.7K
R 7568	J07225104	CARBON FILM RES.	RD16TPJ104	100K	100K

For Service Manuals Contact
MAURITRON TECHNICAL SERVICES
 8 Cherry Tree Rd, Chinnor
 Oxon OX9 4QY
 Tel: 01844-351654 Fax: 01844-352554
 Email: enquiries@mauritron.co.uk

Tuner Control Unit Parts List

ADD	CODE NO	DESCRIPTION	DEVICE	TYP	VAL
R 7569	J07225104	CARBON FILM RES.	RD16TPJ104 100K	100K	1/6W
R 7570	J07225104	CARBON FILM RES.	RD16TPJ104 100K	100K	1/6W
R 7571	J07225104	CARBON FILM RES.	RD16TPJ104 100K	100K	1/6W
R 7572	J07225104	CARBON FILM RES.	RD16TPJ104 100K	100K	1/6W
R 7573	J07225104	CARBON FILM RES.	RD16TPJ104 100K	100K	1/6W
R 7574	J07225470	CARBON FILM RES.	RD16TPJ470 47	47	1/6W
R 7575	J07225470	CARBON FILM RES.	RD16TPJ470 47	47	1/6W
R 7576	J07225470	CARBON FILM RES.	RD16TPJ470 47	47	1/6W
R 7577	J07225470	CARBON FILM RES.	RD16TPJ470 47	47	1/6W
R 7578	J07225470	CARBON FILM RES.	RD16TPJ470 47	47	1/6W
R 7579	J07225470	CARBON FILM RES.	RD16TPJ470 47	47	1/6W
R 7580	J07225470	CARBON FILM RES.	RD16TPJ470 47	47	1/6W
R 7581	J07225470	CARBON FILM RES.	RD16TPJ470 47	47	1/6W
R 7582	J07225470	CARBON FILM RES.	RD16TPJ470 47	47	1/6W
R 7583	J07225470	CARBON FILM RES.	RD16TPJ470 47	47	1/6W
R 7584	J07225470	CARBON FILM RES.	RD16TPJ470 47	47	1/6W
R 7585	J07225470	CARBON FILM RES.	RD16TPJ470 47	47	1/6W
R 7586	J07225103	CARBON FILM RES.	RD16TPJ103 10K	10K	1/6W
R 7587	J07225102	CARBON FILM RES.	RD16TPJ102 1K	1K	1/6W
R 7588	J07225102	CARBON FILM RES.	RD16TPJ102 1K	1K	1/6W
R 7589	J07225102	CARBON FILM RES.	RD16TPJ102 1K	1K	1/6W
R 7590	J07225102	CARBON FILM RES.	RD16TPJ102 1K	1K	1/6W
R 7591	J07225102	CARBON FILM RES.	RD16TPJ102 1K	1K	1/6W
S 7501	N6090066	SLIDE SWITCH	SS912L4NS		
TP7501	Q5000026	TP-F	TP-F IPS-1032		
TP7502	Q5000026	TP-F	TP-F IPS-1032		
VR7501	J51745223	POT.	H0651A015-22KB	22KB	
VR7502	J51745223	POT.	H0651A015-22KB	22KB	

Notes

For Service Manuals Contact
MAURITRON TECHNICAL SERVICES
8 Cherry Tree Rd, Chinnor
Oxon OX9 4QY
Tel: 01844-351694 Fax: 01844-352554
Email: enquiries@mauritron.co.uk

For Service Manuals Contact
MAURITRON TECHNICAL SERVICES
8 Cherry Tree Rd, Chinnor
Oxon OX9 4QY
Tel: 01844-351694 Fax: 01844-359594
Email: enquiries@mauritron.co.uk

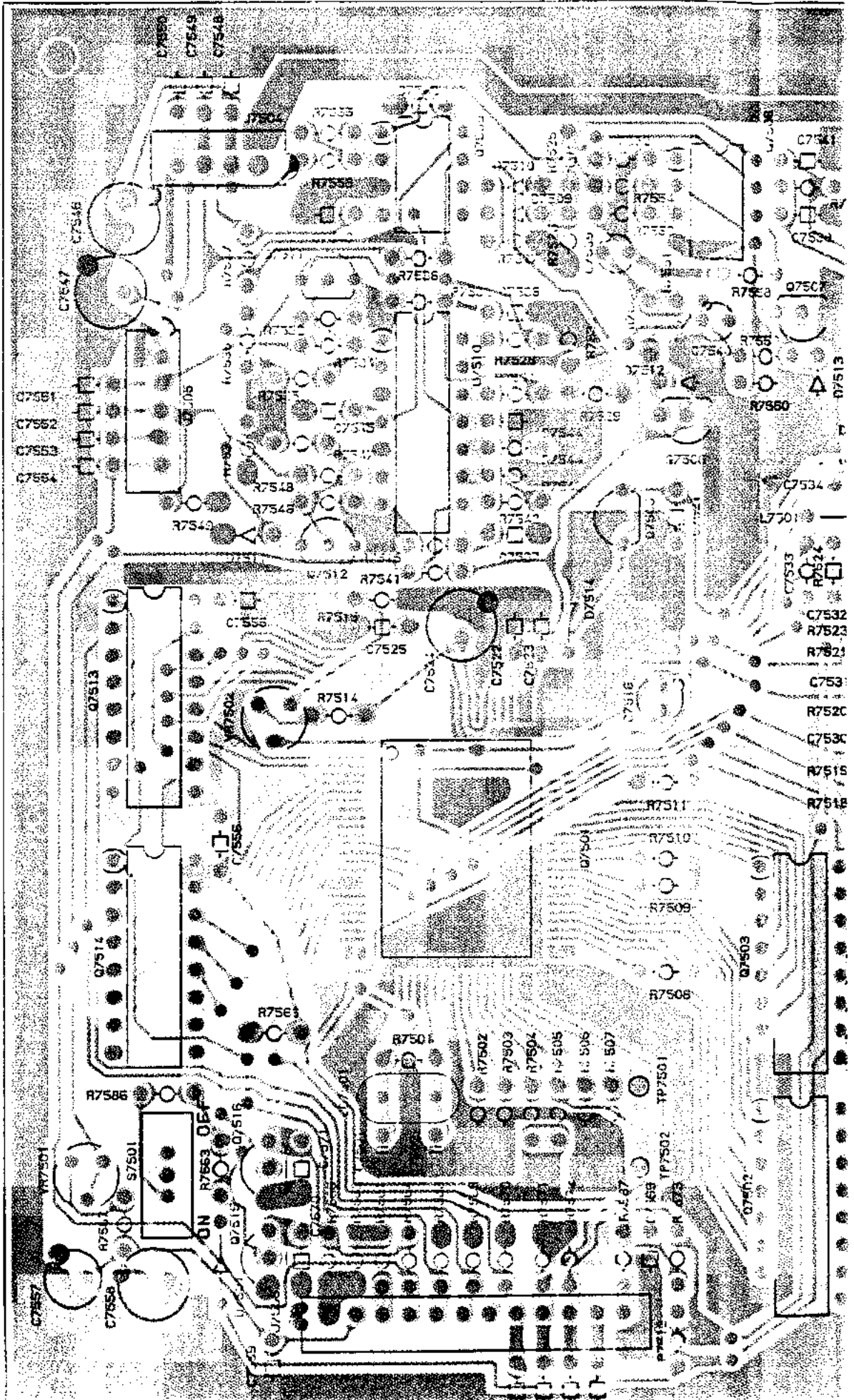

For Service Manuals Contact
MAURITRON TECHNICAL SERVICES
8 Cherry Tree Rd, Chinnor
Oxon OX9 4DF
Tel: 01844 351694 Fax: 01844 352554
Email: enquiries@mauritron.co.uk

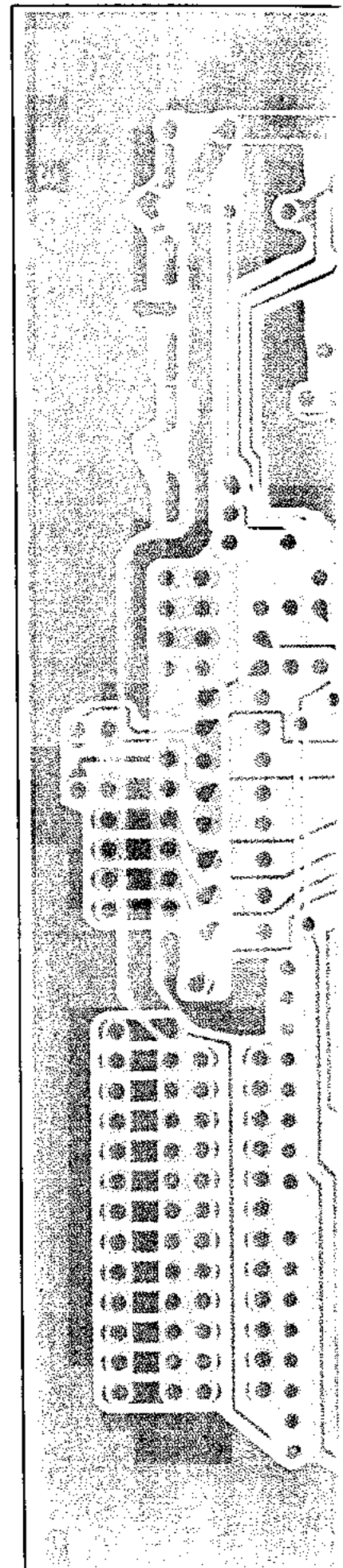
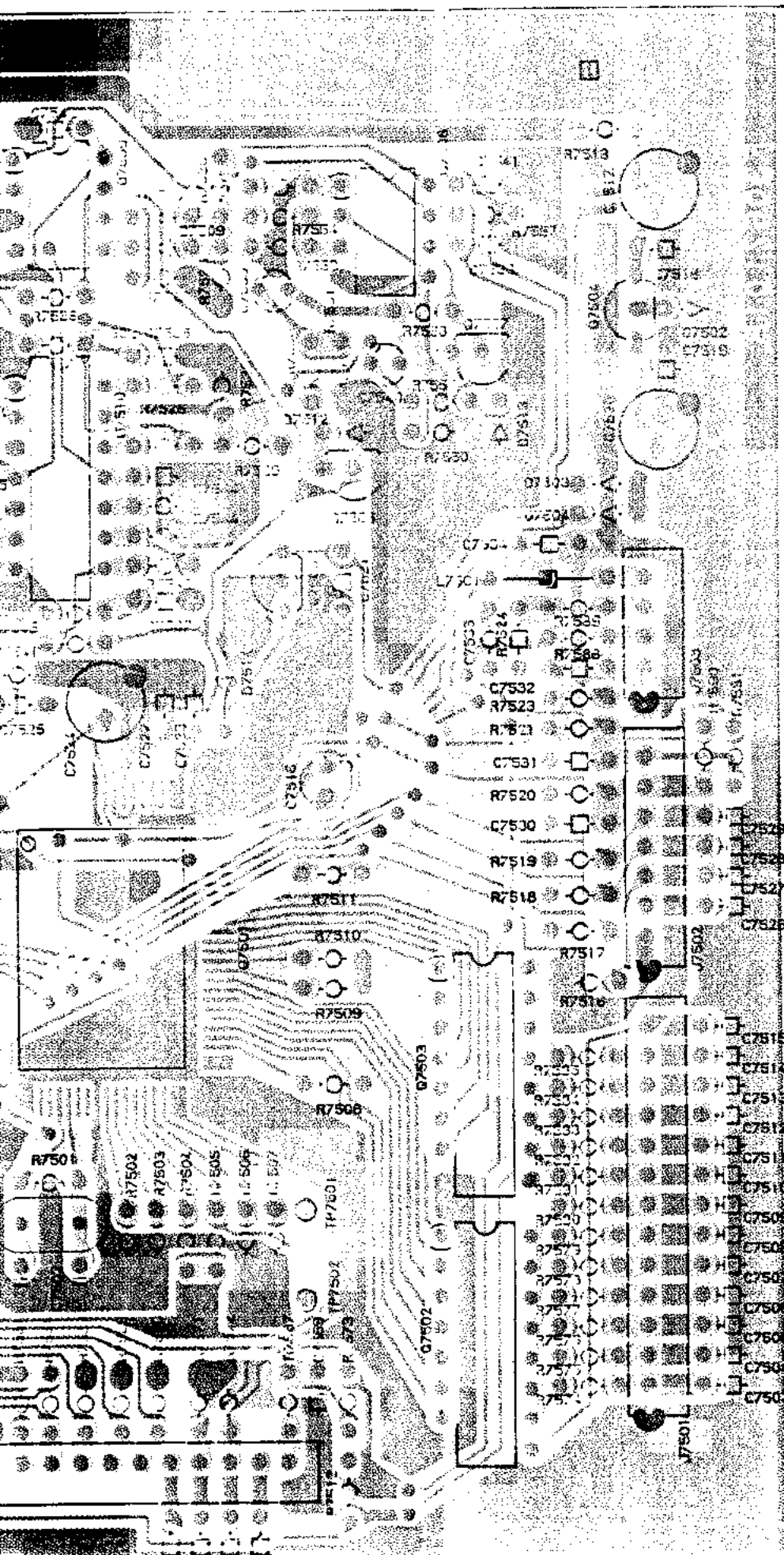

07502
07515

07503
07530
07591

07529
07528
07527
07525

07502

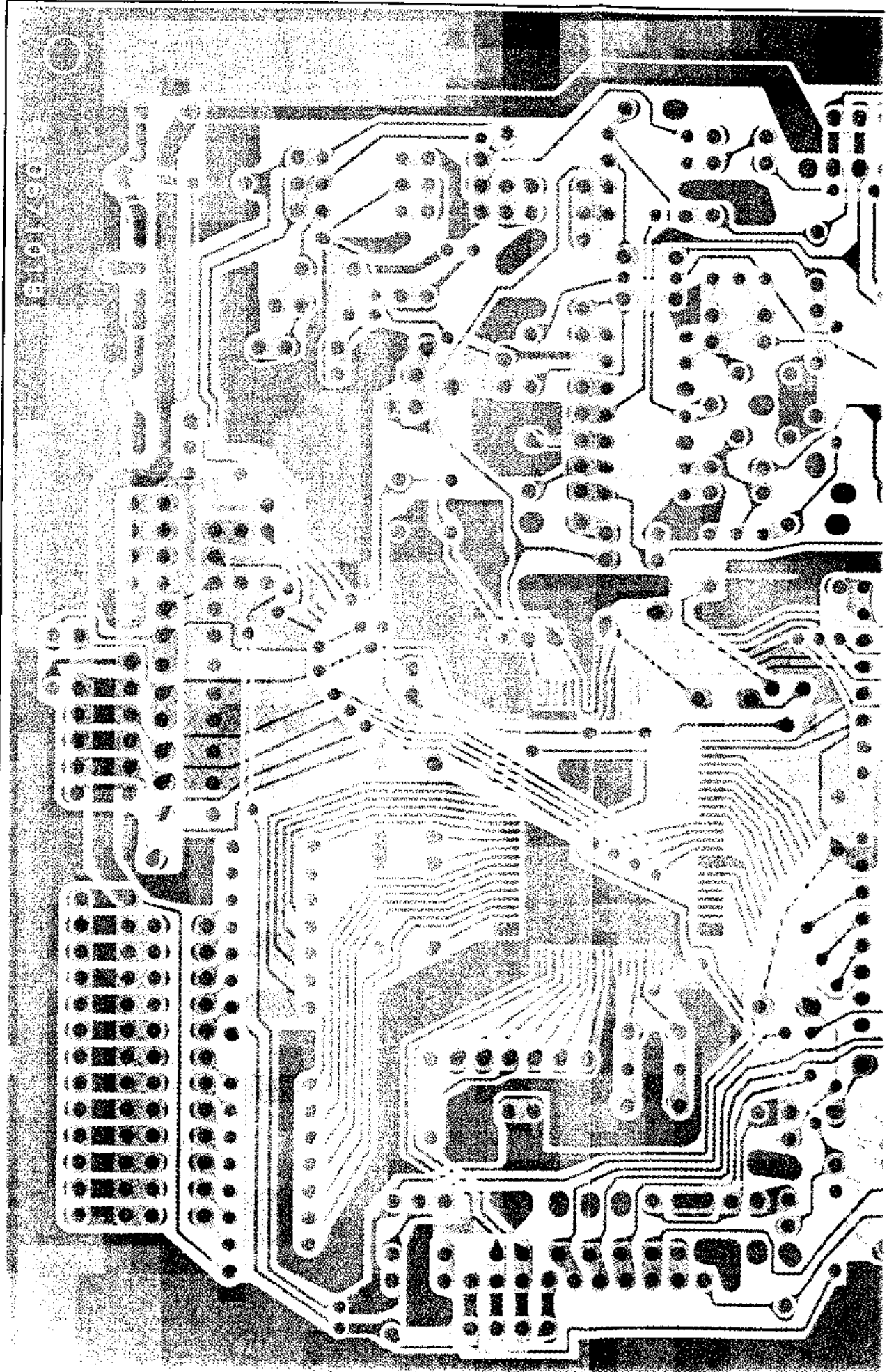

Tuner Control Unit Board Layout

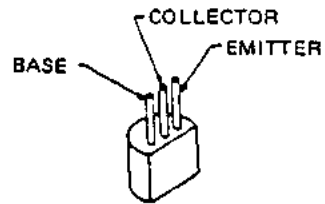
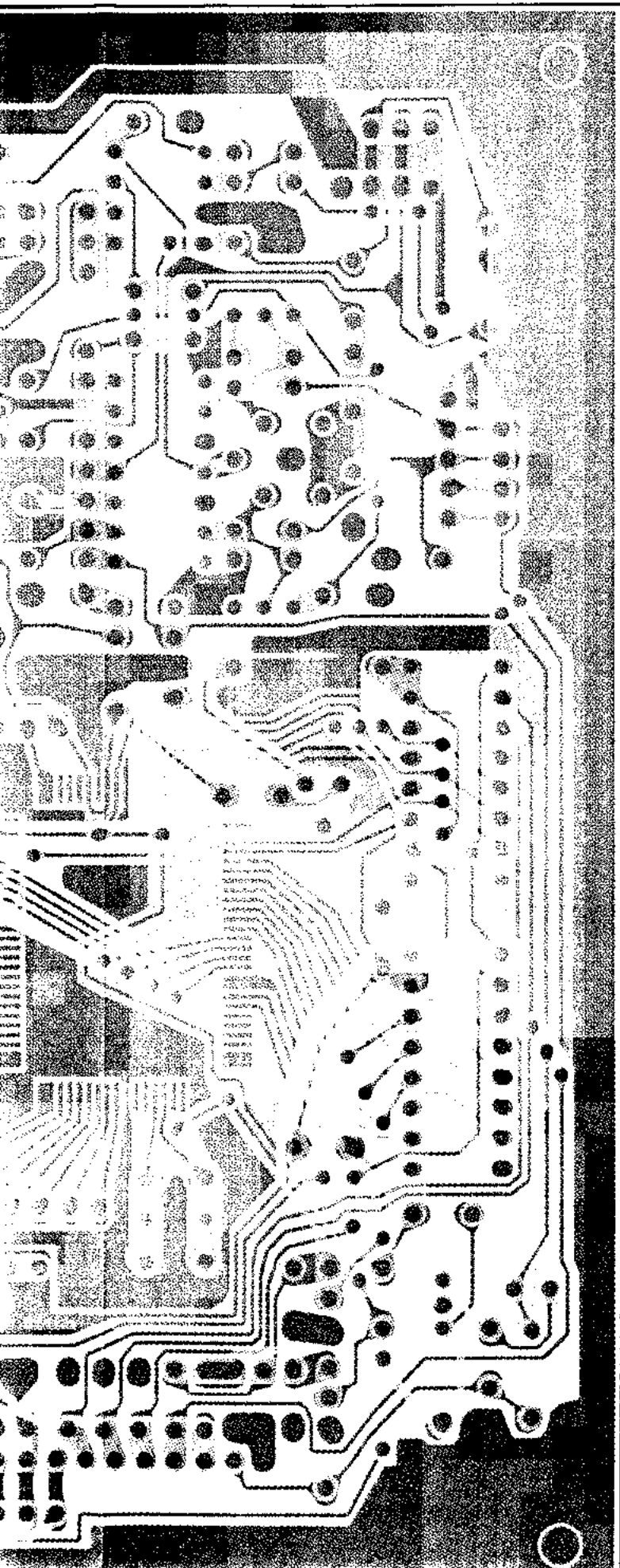

2SC458BTZ
(Q7506, Q7507,
Q7515, Q7516)

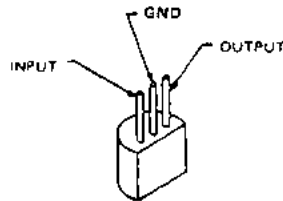

μPC78L05J
(Q7504, Q7505)

For Service Manuals Contact
MAURITRON TECHNICAL SERVICES
8 Cherry Tree Rd, Chinnor
Oxon OX9 4QY
Tel: 01844 351694 Fax: 01844 352554
Email: enquires@mauriron.co.uk

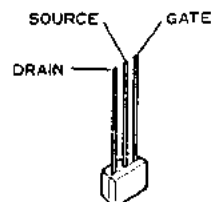

2SK104J
(Q7511, Q7512)

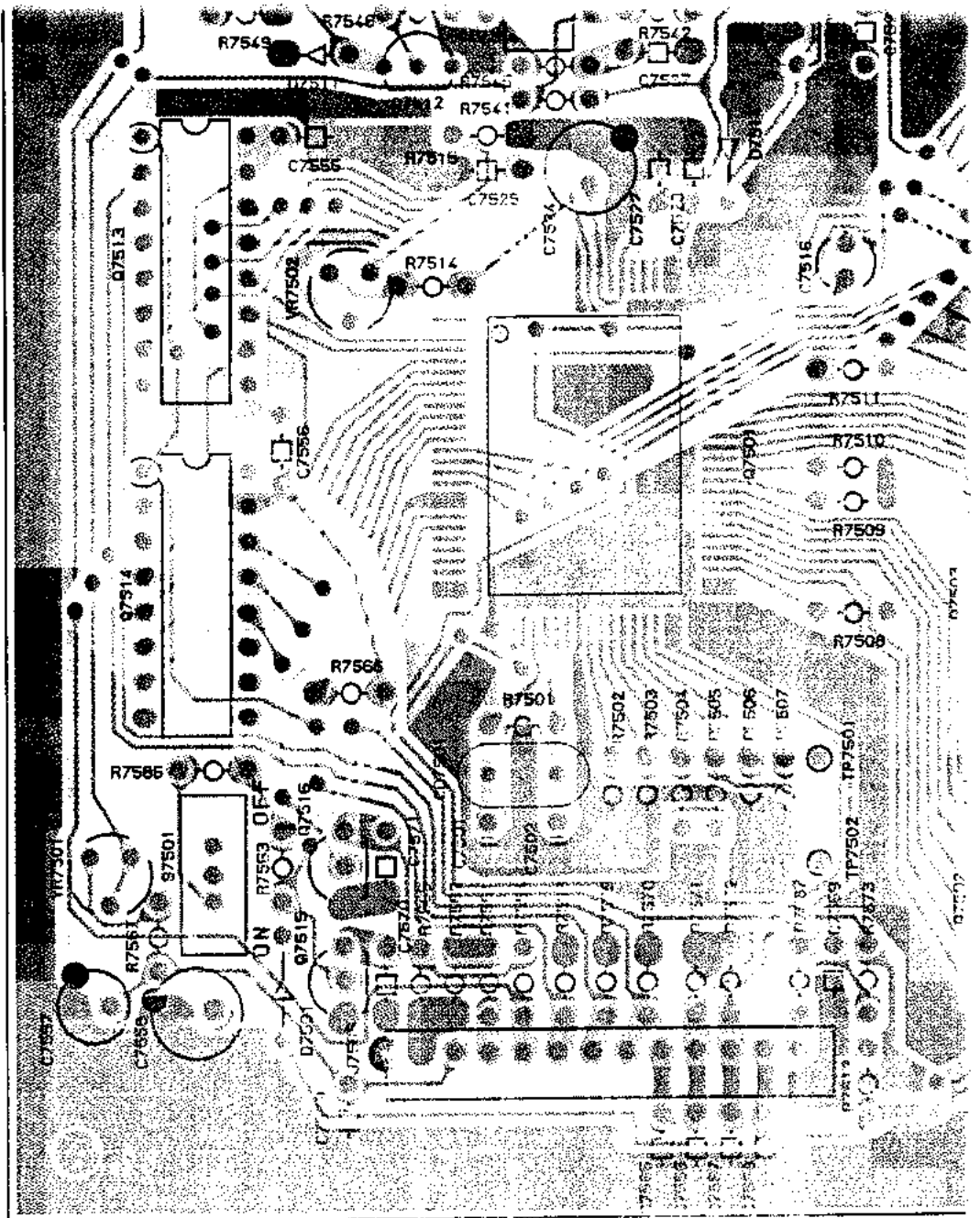

(obverse)

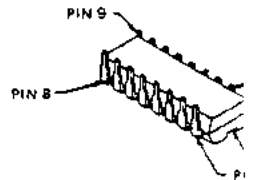
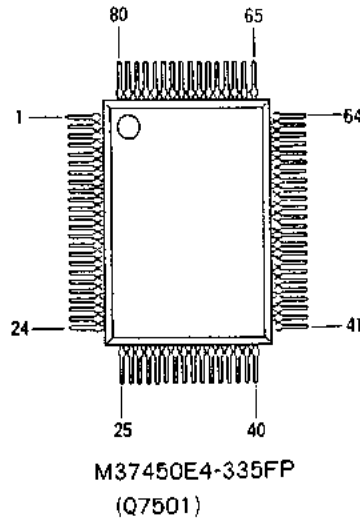

μPD4094BC
(Q7513, Q7514)
μPA2003C
(Q7502, Q7503)

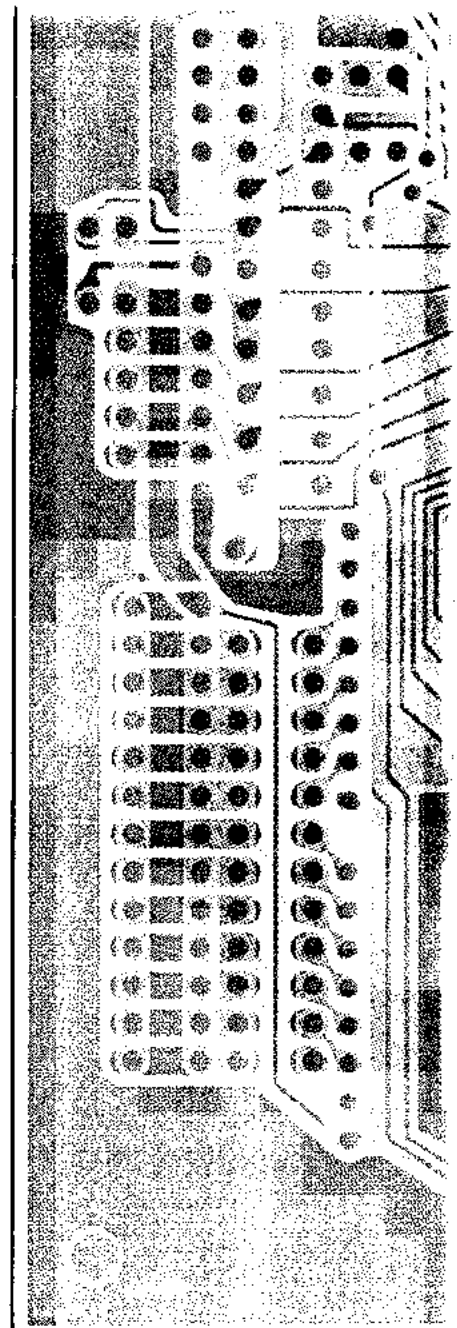
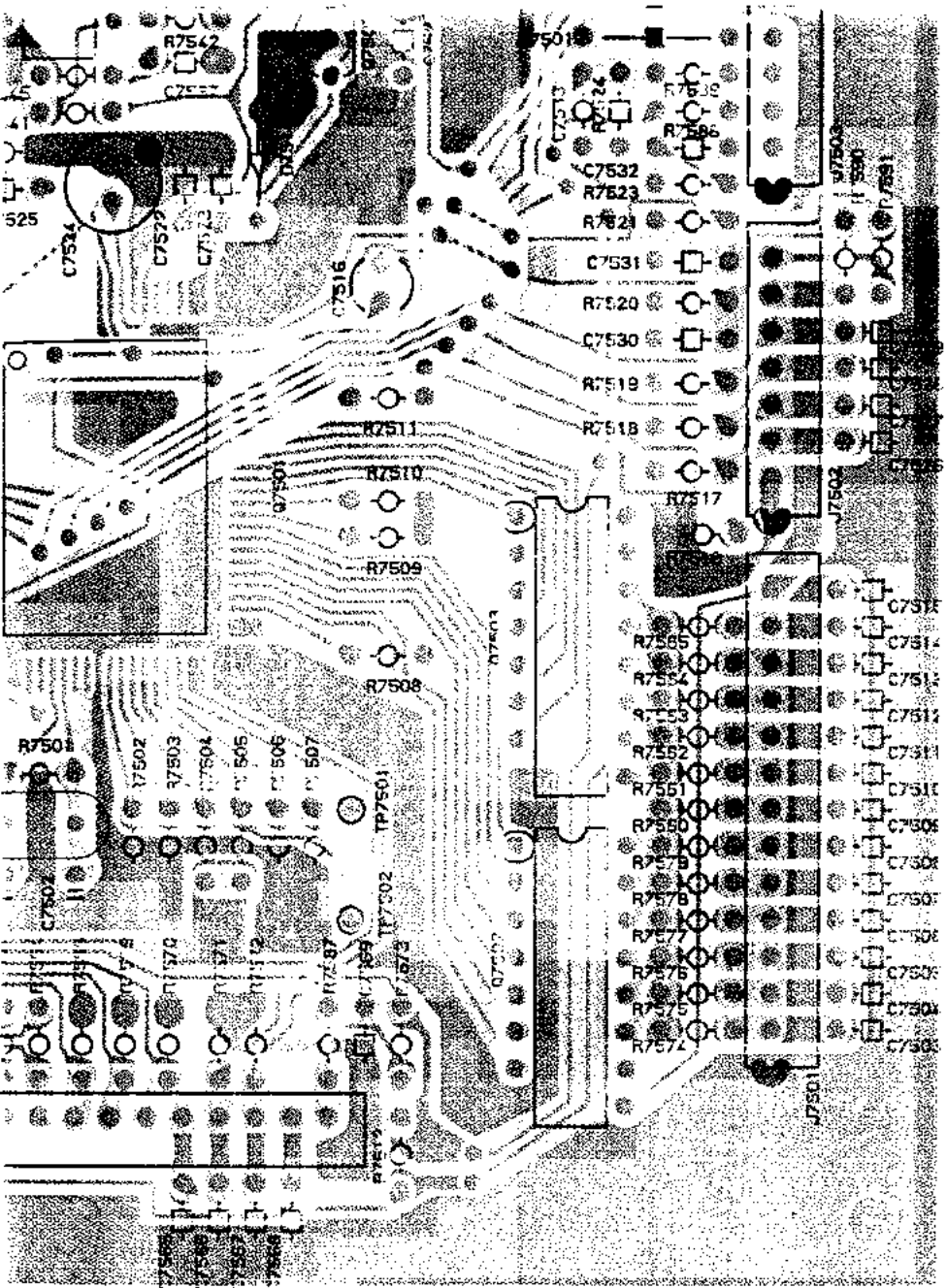

(obverse view of "component" side)

For Service Manuals Contact
MAURITRON TECHNICAL SERVICES
 8 Cherry Tree Rd, Chinnor
 Oxon OX9 4QY
 Tel:- 01844-351694 Fax:- 01844-352554
 Email:- enquiries@mauritron.co.uk

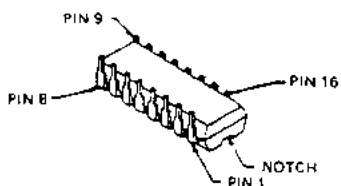

μPD4094BC
 (Q7513, Q7514)
 μPA2003C
 (Q7502, Q7503)

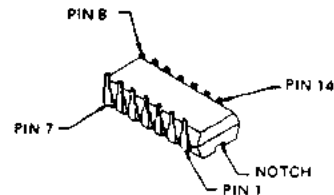

μPC324C
 (Q7510)

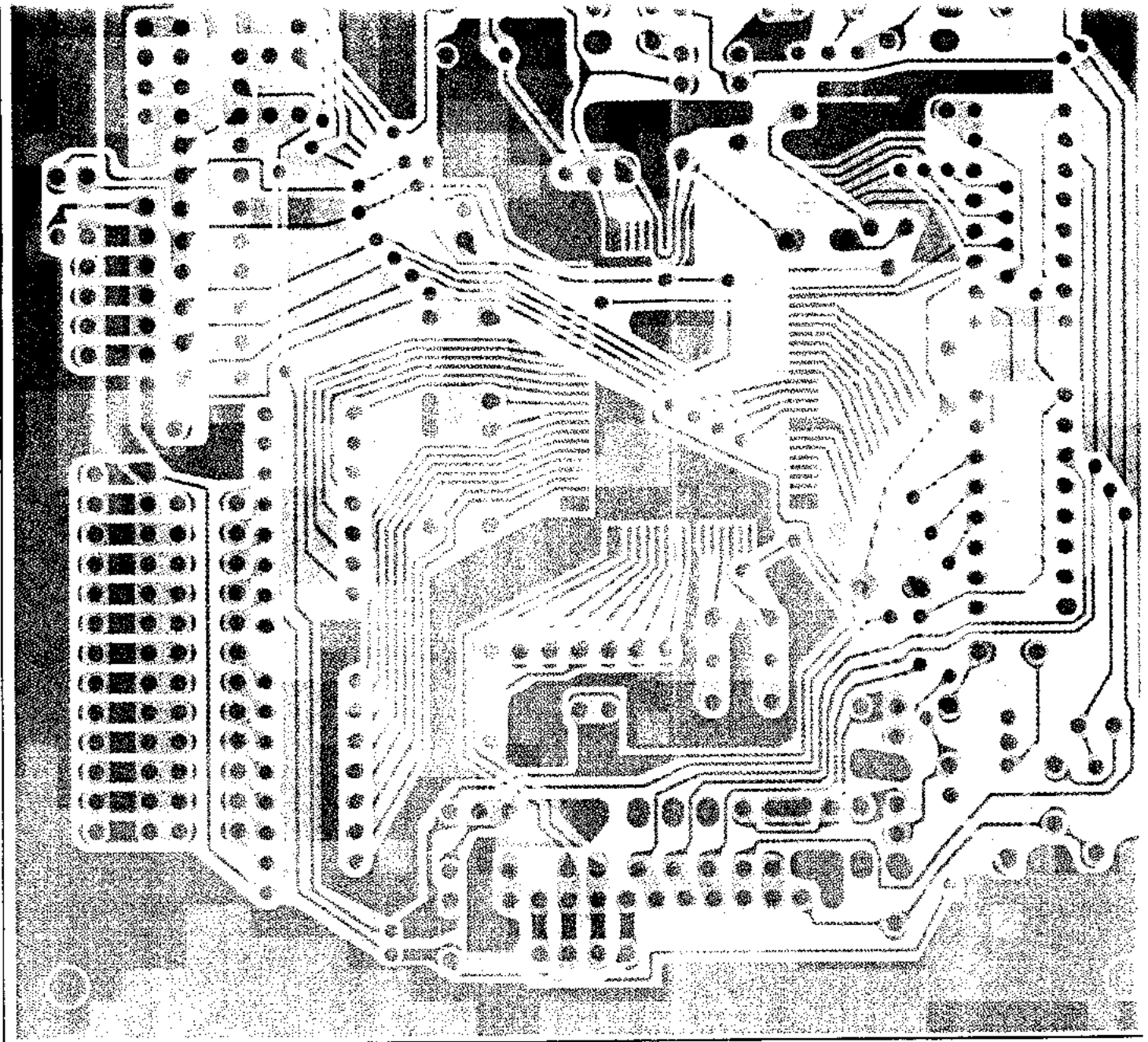

(obverse view of "solder" side)

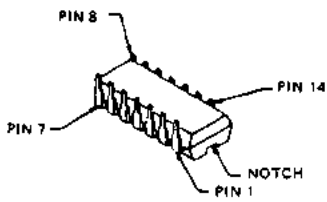

μ PC324C
(Q7510)

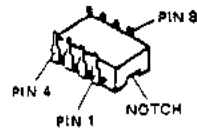

μ PC358C
(Q7509)
 μ PC393C
(Q7508)

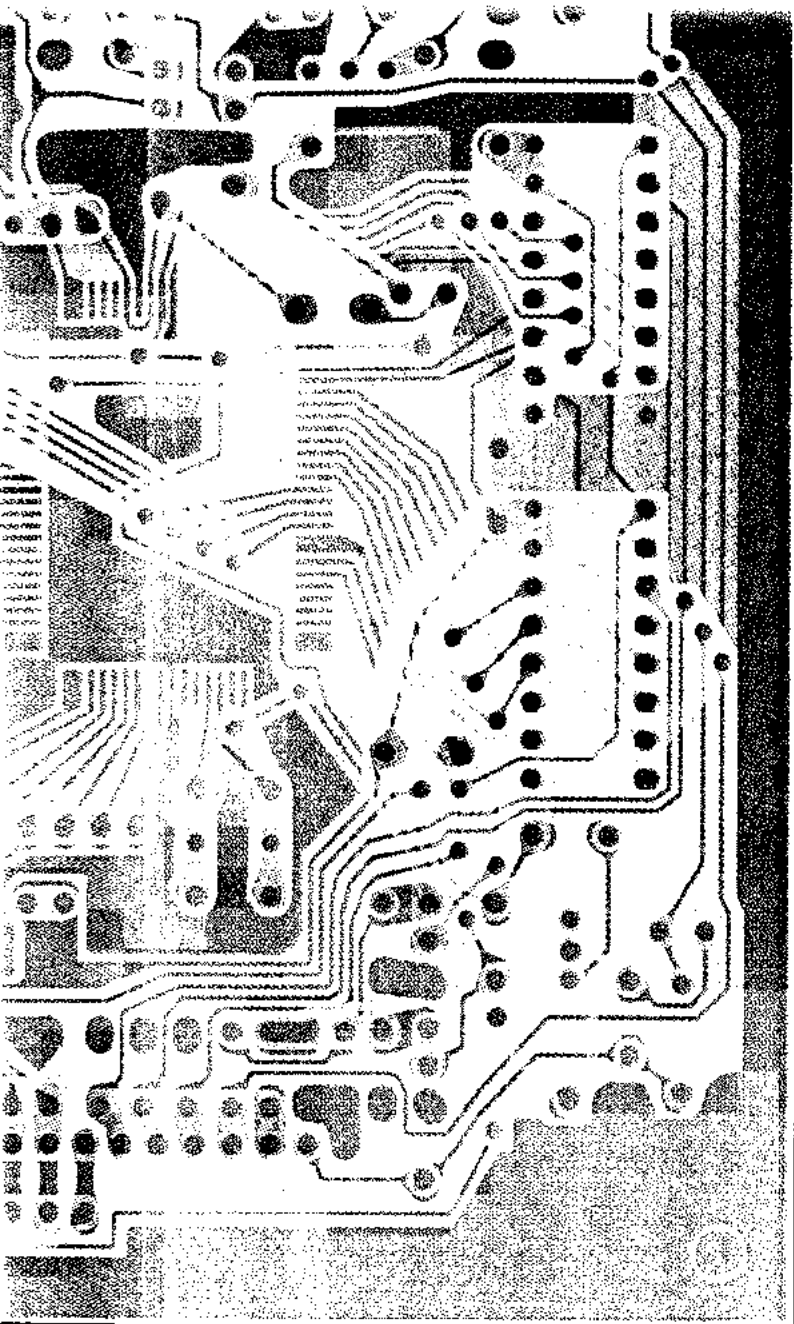

(obverse view of "solder" side)

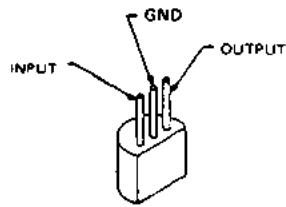

μ PC78L05J
(Q7504, Q7505)

For Service Manuals Contact
MAURITRON TECHNICAL SERVICES
 8 Cherry Tree Rd, Chinnor
 Oxon OX9 4QY
 Tel: 01844-351694 Fax: 01844-352554
 Email: enquiries@mauritron.co.uk

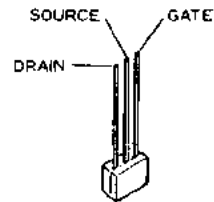

2SK104J
(Q7511, Q7512)

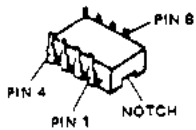

μ PC358C
(Q7509)
 μ PC393C
(Q7508)

For Service Manuals Contact
MAURITRON TECHNICAL SERVICES
 8 Chery Tree Rd, Chinnor
 Oxon OX9 4QY
 Tel: 01844-351694 Fax: 01844-352554
 Email: enquiries@maurtron.co.uk

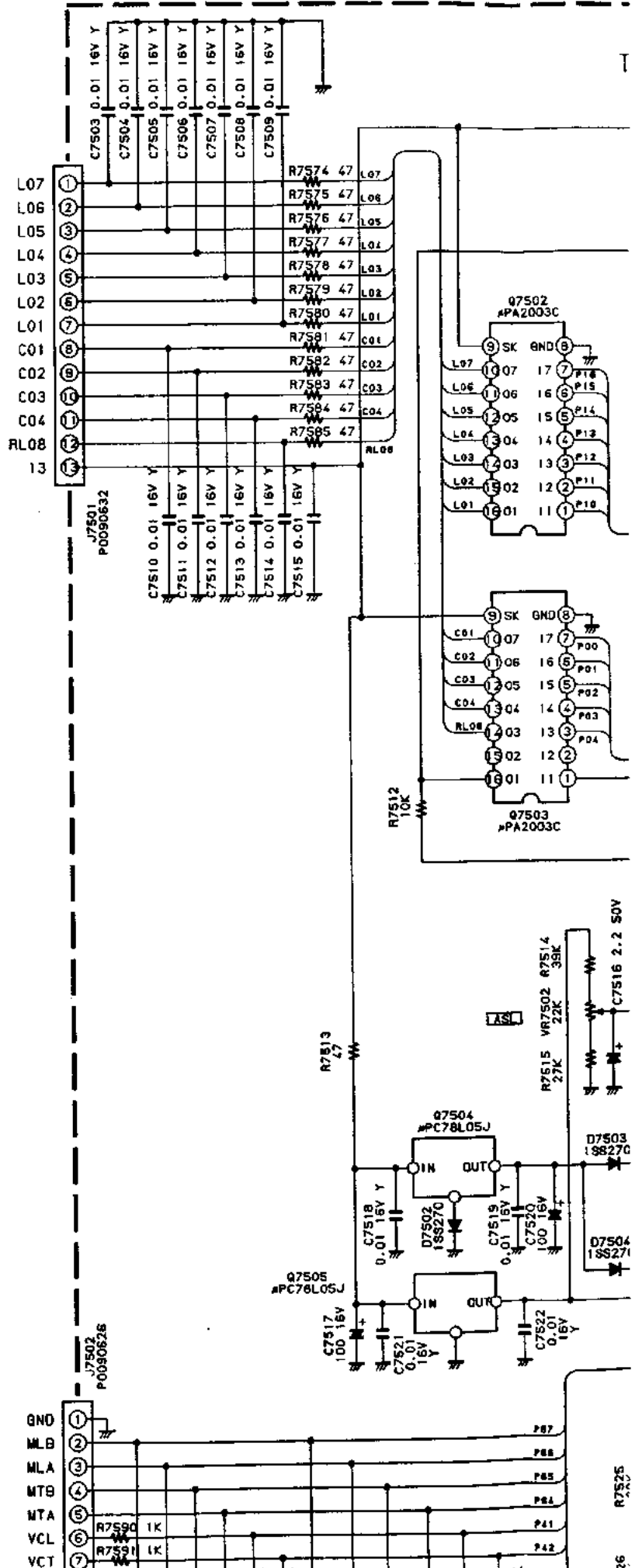

TUNER CNTL UNIT

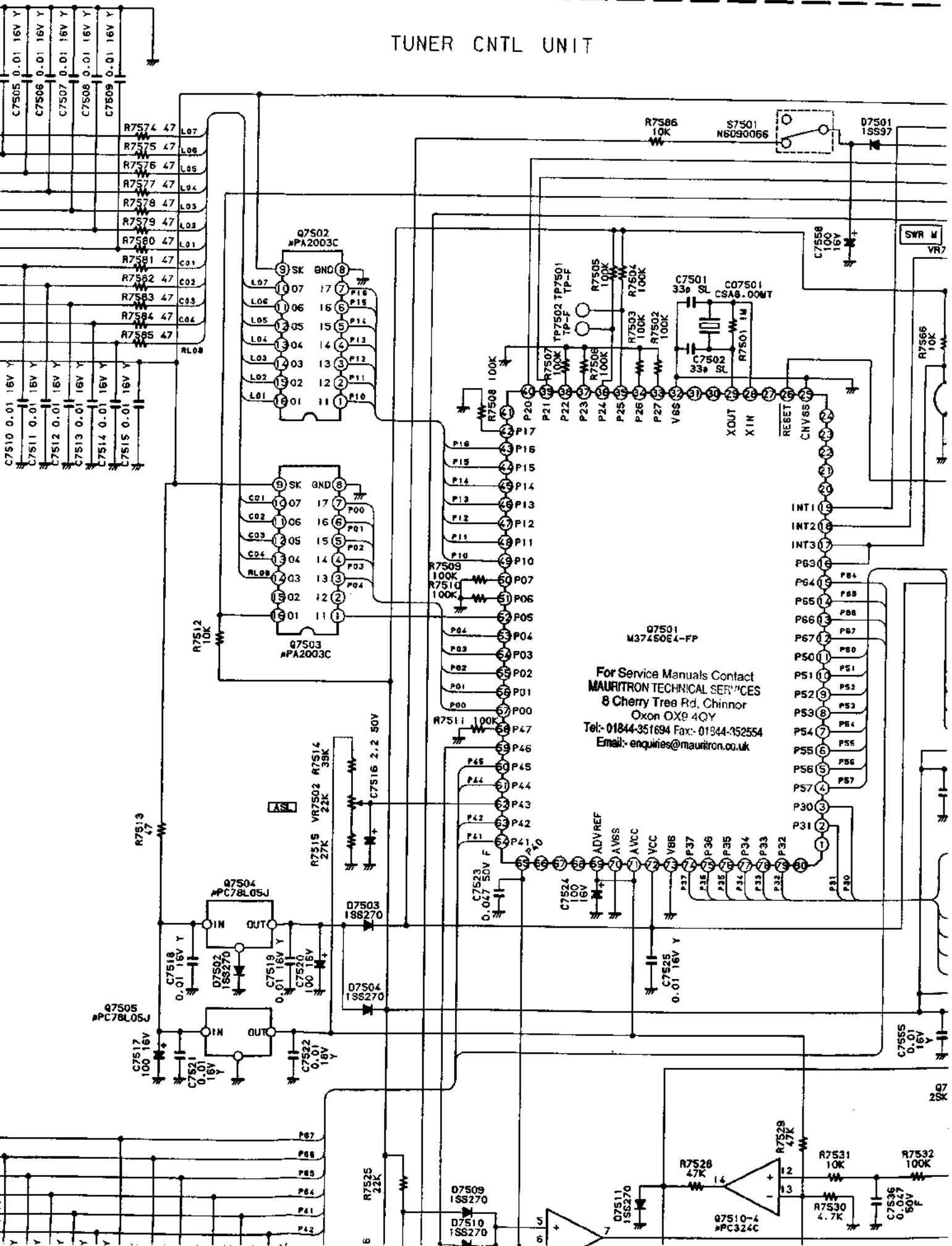

For Service Manuals Contact
MAURITRON TECHNICAL SERVICES
 8 Cherry Tree Rd, Chinnor
 Oxon OX9 4QY
 Tel: 01844-351694 Fax: 01844-352554
 Email: enquiries@mauritron.co.uk

Tuner Contro

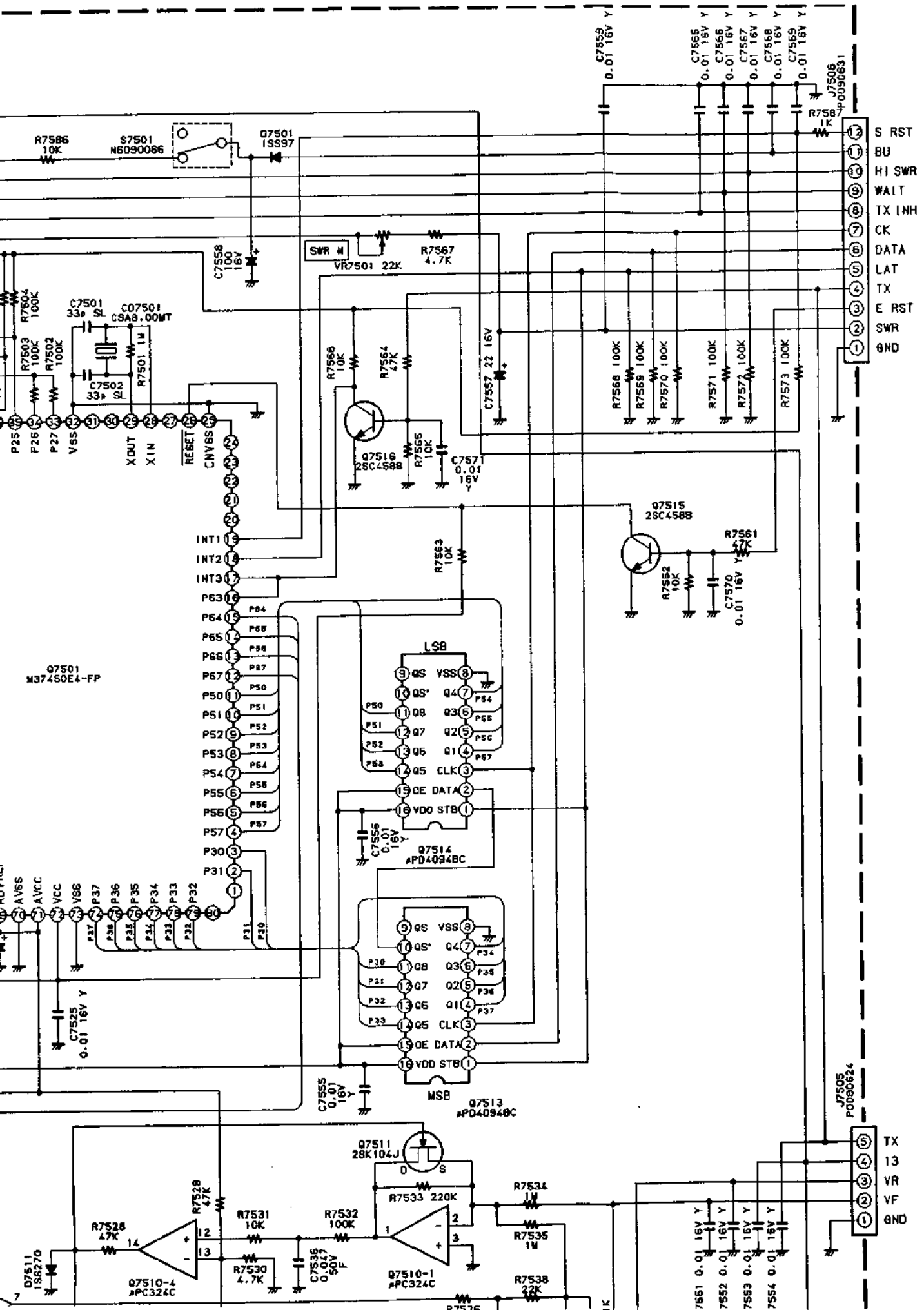

Tuner Control Unit Schematic Diagram

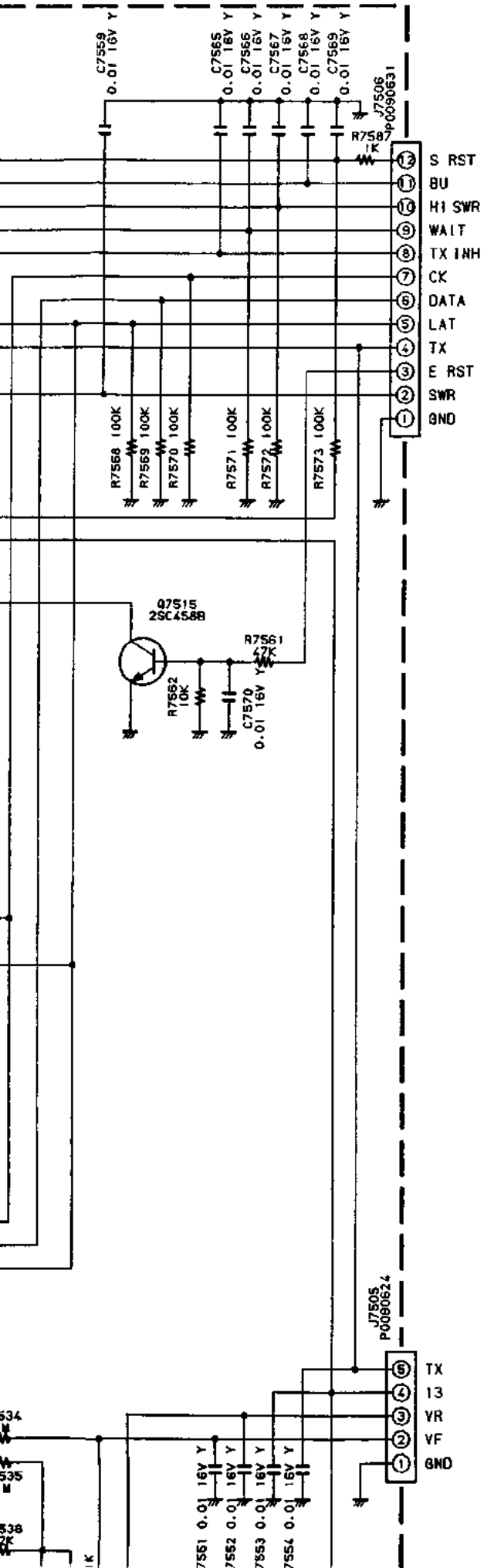

For Service Manuals Contact
MAURITRON TECHNICAL SERVICES
 8 Cherry Tree Rd, Chinnor
 Oxon OX9 4QY
 Tel: 01844-351694 Fax: 01844-352554
 Email: enquiries@mauritron.co.uk

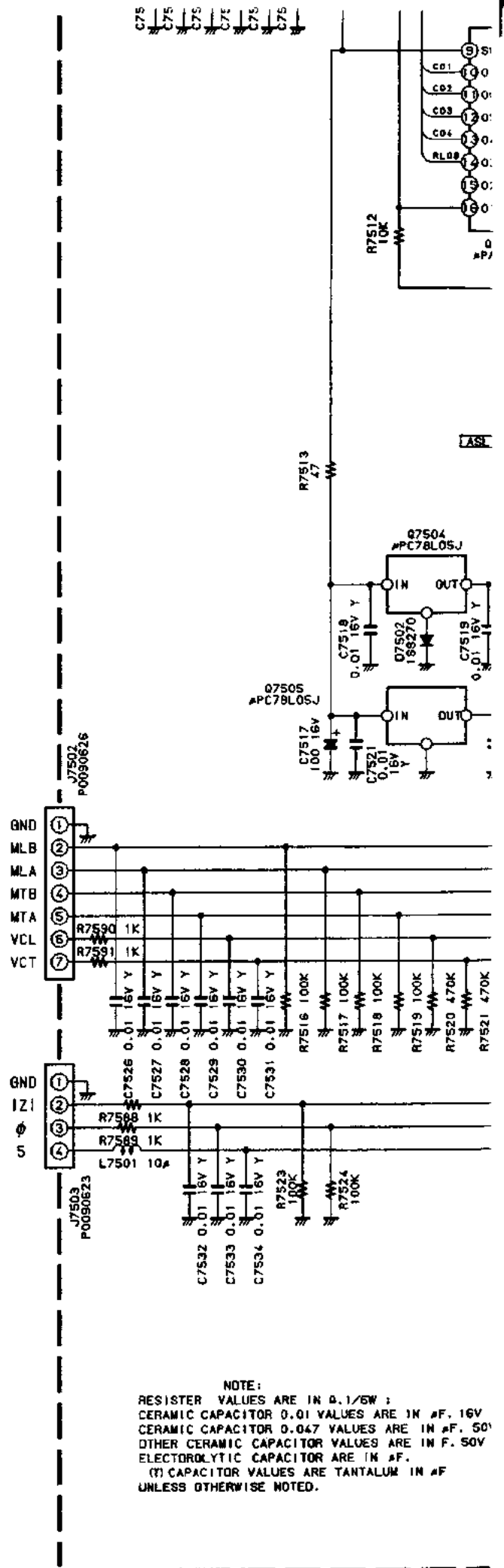

NOTE:
 RESISTOR VALUES ARE IN Ω, 1/6W ;
 CERAMIC CAPACITOR 0.01 VALUES ARE IN μF, 16V
 CERAMIC CAPACITOR 0.047 VALUES ARE IN μF, 50V
 OTHER CERAMIC CAPACITOR VALUES ARE IN F, 50V
 ELECTROLYTIC CAPACITOR ARE IN μF.
 (Y) CAPACITOR VALUES ARE TANTALUM IN μF
 UNLESS OTHERWISE NOTED.

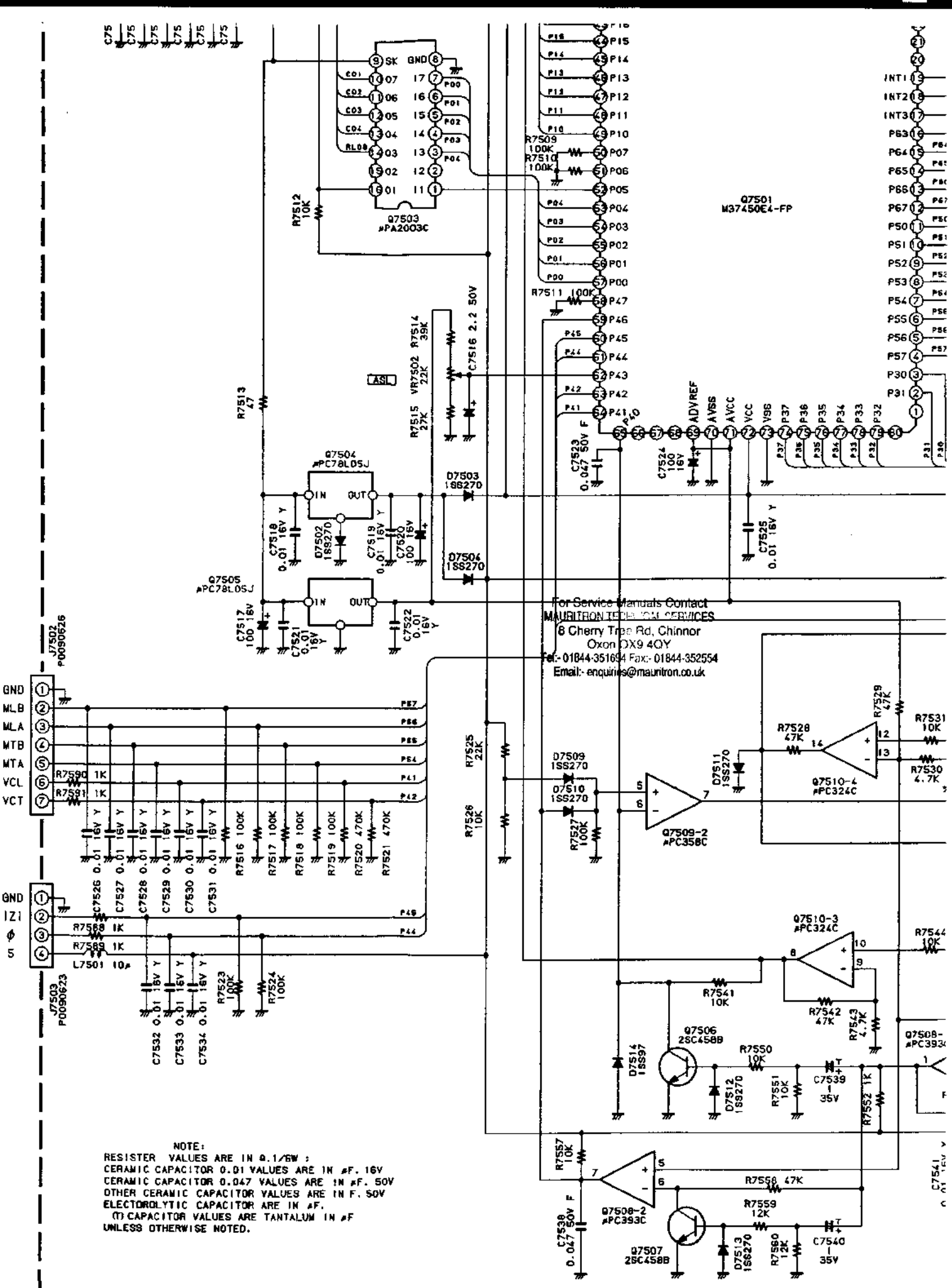

For Service Manuals Contact
MAURITRON TECHNICAL SERVICES
 6 Cherry Tree Rd, Chinnor
 Oxon OX9 4QY
 Tel: 01844 351654 Fax: 01844 352554
 Email: enquiries@mauritron.co.uk

NOTE:
 RESISTOR VALUES ARE IN Ω, KΩ, MΩ ;
 CERAMIC CAPACITOR 0.01 VALUES ARE IN μF, 16V
 CERAMIC CAPACITOR 0.047 VALUES ARE IN μF, 50V
 OTHER CERAMIC CAPACITOR VALUES ARE IN F, 50V
 ELECTROLYTIC CAPACITOR ARE IN μF.
 (T) CAPACITOR VALUES ARE TANTALUM IN μF
 UNLESS OTHERWISE NOTED.

C7541
 0.01 16V Y

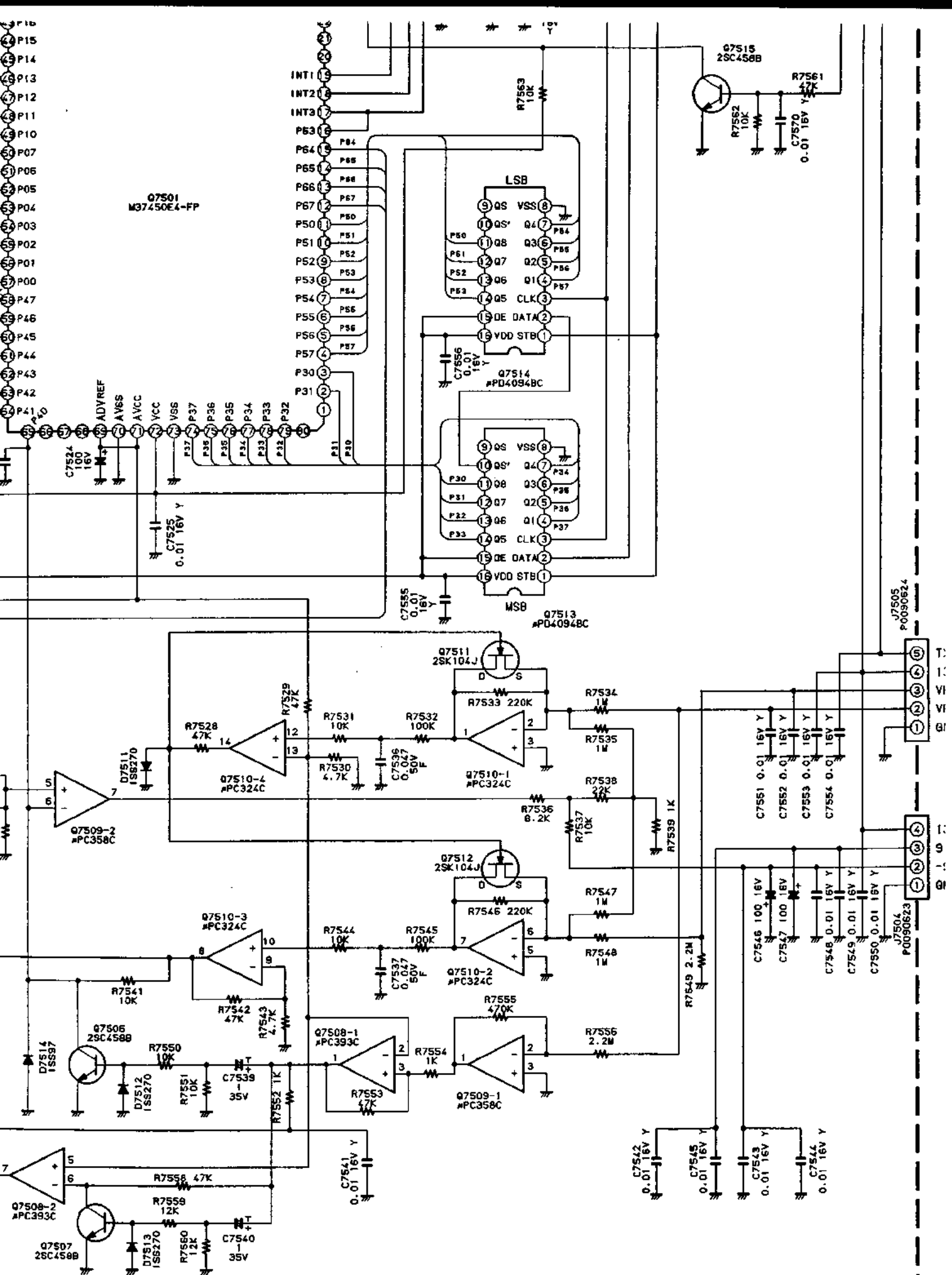

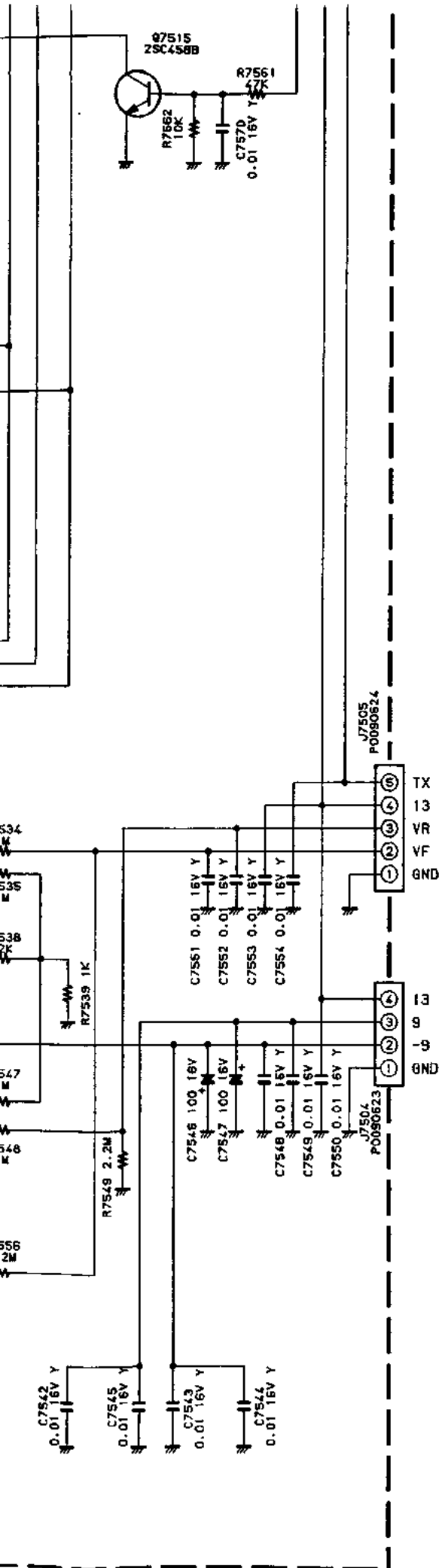

For Service Manuals Contact
MAURITRON TECHNICAL SERVICES
 8 Cherry Tree Rd, Chinnor
 Oxon OX9 4QY
 Tel: 01844-351694 Fax: 01844-352554
 Email: enquiries@mauritron.co.uk

DDS A/B Unit Parts List

ADD	CODE NO	DESCRIPTION	DEVICE	TYP VAL			
** UNIT NAME : DDS-A-UNIT							
C	7701	K22170215	CHIP CAP.	GRM40CH150J50PT	15pF	50V	CH
C	7702	K22170217	CHIP CAP.	GRM40CH180J50PT	18pF	50V	CH
C	7703	K22141809	CHIP CAP.	GRM42-6B104M25PT	0.1uF	25V	B
C	7704	K78120009	TANTALUM CHIP CAP.	TESVA1C105M1-8R	1uF	16V	
C	7705	K22141809	CHIP CAP.	GRM42-6B104M25PT	0.1uF	25V	B
C	7706	K22170807	CHIP CAP.	GRM40B152M50PT	0.0015	50V	B
C	7707	K22170235	CHIP CAP.	GRM40CH101J50PT	100pF	50V	CH
C	7708	K22170809	CHIP CAP.	GRM40B222M50PT	0.0022uF	50V	B
C	7709	K22170811	CHIP CAP.	GRM40B332M50PT	0.0033uF	50V	B
C	7710	K22170247	CHIP CAP.	GRM40CH331J50PT	330pF	50V	CH
C	7711	K22170805	CHIP CAP.	GRM40B102M50PT	0.001uF	50V	B
C	7712	K22170809	CHIP CAP.	GRM40B222M50PT	0.0022uF	50V	B
C	7713	K22170809	CHIP CAP.	GRM40B222M50PT	0.0022uF	50V	B
C	7714	K22170247	CHIP CAP.	GRM40CH331J50PT	330pF	50V	CH
C	7715	K22170809	CHIP CAP.	GRM40B222M50PT	0.0022uF	50V	B
C	7716	K22170251	CHIP CAP.	GRM40CH471J50PT	470pF	50V	CH
C	7717	K22141809	CHIP CAP.	GRM42-6B104M25PT	0.1uF	25V	B
C	7718	K22170227	CHIP CAP.	GRM40CH470J50PT	47pF	50V	CH
C	7719	K22141809	CHIP CAP.	GRM42-6B104M25PT	0.1uF	25V	B
C	7720	K22141809	CHIP CAP.	GRM42-6B104M25PT	0.1uF	25V	B
C	7721	K22141809	CHIP CAP.	GRM42-6B104M25PT	0.1uF	25V	B
C	7722	K78120009	TANTALUM CHIP CAP.	TESVA1C105M1-8R	1uF	16V	
C	7723	K78120009	TANTALUM CHIP CAP.	TESVA1C105M1-8R	1uF	16V	
C	7724	K22141809	CHIP CAP.	GRM42-6B104M25PT	0.1uF	25V	B
C	7725	K22170235	CHIP CAP.	GRM40CH101J50PT	100pF	50V	CH
C	7726	K22170235	CHIP CAP.	GRM40CH101J50PT	100pF	50V	CH
C	7727	K22170235	CHIP CAP.	GRM40CH101J50PT	100pF	50V	CH
C	7728	K22170817	CHIP CAP.	GRM40B103M50PT	0.01uF	50V	B
L	7701	L1190222	M RFC	LAL03NA221K	220uH		
L	7702	L1190203	M.RFC	LAL03NA4R7K	4.7uH		
L	7703	L1190205	M.RFC	LAL03NA6R8K	6.8uH		
L	7704	L1190206	M.RFC	LAL03NA8R2K	8.2uH		
Q	7701	G3316237F	TRANSISTOR	2SC1623-T2BL6			
Q	7702	G1090970	IC	TC23SC030AF-50L			
Q	7703	G1090887	IC	NJM78L05UA			
Q	7704	G3316237F	TRANSISTOR	2SC1623-T2BL6			
R	7701	J24205104	CHIP RES.	RMC1/10T 104J	100K	1/10W	
R	7702	J24205101	CHIP RES.	RMC1/10T 101J	100	1/10W	
R	7703	J24205390	CHIP RES.	RMC1/10T 390J	39	1/10W	
R	7704	J24205104	CHIP RES.	RMC1/10T 104J	100K	1/10W	
R	7705	J24205102	CHIP RES.	RMC1/10T 102J	1K	1/10W	
R	7706	J24205102	CHIP RES.	RMC1/10T 102J	1K	1/10W	
R	7707	J24205102	CHIP RES.	RMC1/10T 102J	1K	1/10W	
R	7708	J24205102	CHIP RES.	RMC1/10T 102J	1K	1/10W	
R	7709	J24205104	CHIP RES.	RMC1/10T 104J	100K	1/10W	
RB	7701	J40900171	BLOCK RES.	EXB-LD10103GC	EXB-LD1010	3GC	
T	7701	L0021484	COIL				

DDS A/B Unit Parts List

ADD	CODE NO	DESCRIPTION	DEVICE			TYP VAL
** UNIT NAME : DDS-B-UNIT						
C	7801	K22170215	CHIP CAP.	GRM40CH150J50PT	15pF	50V CH
C	7802	K22170217	CHIP CAP.	GRM40CH180J50PT	18pF	50V CH
C	7803	K22141809	CHIP CAP.	GRM42-6B104M25PT	0.1uF	25V B
C	7804	K78120009	TANTALUM CHIP CAP.	TESVA1C105M1-8R	1uF	16V
C	7805	K22141809	CHIP CAP.	GRM42-6B104M25PT	0.1uF	25V B
C	7806	K22170807	CHIP CAP.	GRM40B152M50PT	0.0015	50V B
C	7807	K22170247	CHIP CAP.	GRM40CH331J50PT	330pF	50V CH
C	7808	K22170805	CHIP CAP.	GRM40B102M50PT	0.001uF	50V B
C	7809	K22170809	CHIP CAP.	GRM40B222M50PT	0.0022uF	50V B
C	7810	K22170805	CHIP CAP.	GRM40B102M50PT	0.001uF	50V B
C	7811	K22170807	CHIP CAP.	GRM40B152M50PT	0.0015	50V B
C	7812	K22170809	CHIP CAP.	GRM40B222M50PT	0.0022uF	50V B
C	7813	K22170806	CHIP CAP.	GRM40B122M50PT	0.0012	50V B
C	7814	K22170247	CHIP CAP.	GRM40CH331J50PT	330pF	50V CH
C	7815	K22170809	CHIP CAP.	GRM40B222M50PT	0.0022uF	50V B
C	7816	K22170243	CHIP CAP.	GRM40CH221J50PT	220pF	50V CH
C	7817	K22141809	CHIP CAP.	GRM42-6B104M25PT	0.1uF	25V B
C	7818	K22170227	CHIP CAP.	GRM40CH470J50PT	47pF	50V CH
C	7819	K22141809	CHIP CAP.	GRM42-6B104M25PT	0.1uF	25V B
C	7820	K22141809	CHIP CAP.	GRM42-6B104M25PT	0.1uF	25V B
C	7821	K22141809	CHIP CAP.	GRM42-6B104M25PT	0.1uF	25V B
C	7822	K78120009	TANTALUM CHIP CAP.	TESVA1C105M1-8R	1uF	16V
C	7823	K78120009	TANTALUM CHIP CAP.	TESVA1C105M1-8R	1uF	16V
C	7824	K22141809	CHIP CAP.	GRM42-6B104M25PT	0.1uF	25V B
C	7825	K22170235	CHIP CAP.	GRM40CH101J50PT	100pF	50V CH
C	7826	K22170235	CHIP CAP.	GRM40CH101J50PT	100pF	50V CH
C	7827	K22170235	CHIP CAP.	GRM40CH101J50PT	100pF	50V CH
C	7828	K22170817	CHIP CAP.	GRM40B103M50PT	0.01uF	50V B
L	7801	L1190222	M RFC LAL03NA221K	LAL03NA221K	220uH	
L	7802	L1190204	M.RFC	LAL03NA5R6K	5.6uH	
L	7803	L1190204	M.RFC	LAL03NA5R6K	5.6uH	
L	7804	L1190205	M.RFC	LAL03NA6R8K	6.8uH	
Q	7801	G3316237F	TRANSISTOR	2SC1623-T2BL6		
Q	7802	G1090970	IC	TC23SC030AF-501		
Q	7803	G1090887	IC	NJM78L05UA		
Q	7804	G3316237F	TRANSISTOR	2SC1623-T2BL6		
R	7801	J24205104	CHIP RES.	RMC1/10T 104J	100K	1/10W
R	7802	J24205101	CHIP RES.	RMC1/10T 101J	100	1/10W
R	7803	J24205390	CHIP RES.	RMC1/10T 390J	39	1/10W
R	7804	J24205104	CHIP RES.	RMC1/10T 104J	100K	1/10W
R	7805	J24205102	CHIP RES.	RMC1/10T 102J	1K	1/10W
R	7806	J24205102	CHIP RES.	RMC1/10T 102J	1K	1/10W
R	7807	J24205102	CHIP RES.	RMC1/10T 102J	1K	1/10W
R	7808	J24205102	CHIP RES.	RMC1/10T 102J	1K	1/10W
R	7809	J24205104	CHIP RES.	RMC1/10T 104J	100K	1/10W
RB	7801	J40900171	BLOCK RES. EXB-LD10103GC	EXB-LD10103GC	EXB-LD1010	3GC
T	7801	L0021484	COIL			

For Service Manuals Contact
MAURITRON TECHNICAL SERVICES
 8 Cherry Tree Rd, Chinnor
 Oxon OX9 4QY
 Tel:- 01844-351694 Fax:- 01844-352554
 Email:- enquiries@mauritron.co.uk

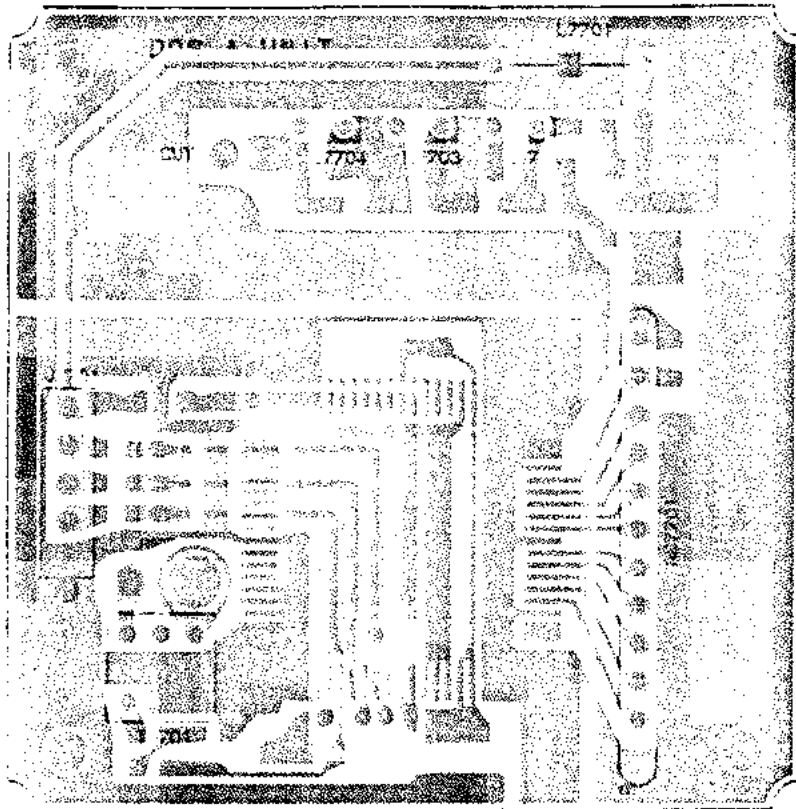

(obverse view of "component" side)

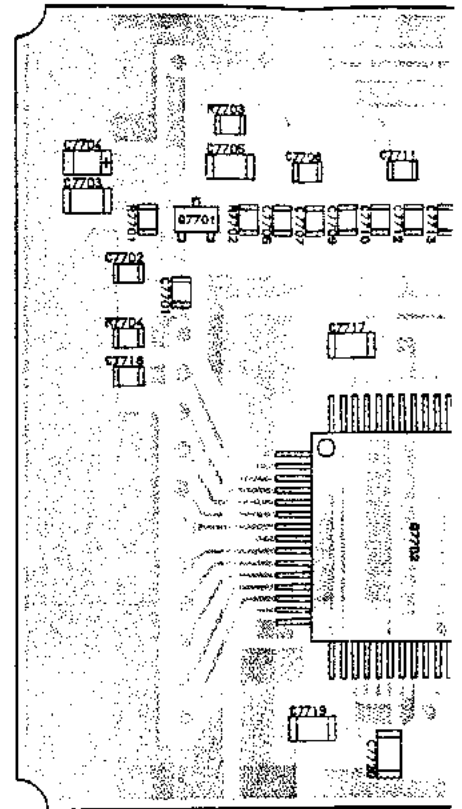

(obverse view of "c

DDS-A UNIT

For Service Manuals Contact
MAURITRON TECHNICAL SERVICES
 8 Cherry Tree Rd. Chinnor
 Oxon OX9 4QY
 Tel: 01844-351694 Fax: 01844-352854
 Email: enquiries@maurtron.co.uk

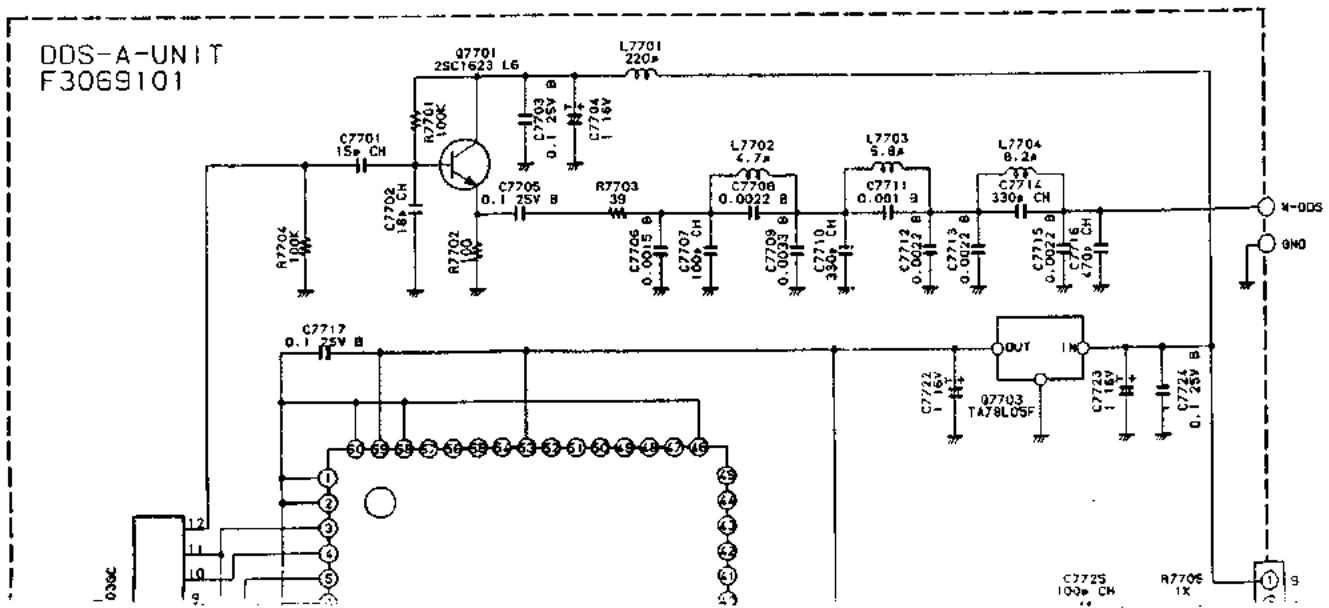

For Service Manuals Contact
 MAURITRON TECHNICAL SERVICES
 8 Cherry Tree Rd, Chinnor
 Oxon OX9 4QY
 Tel: 01844-351634 Fax: 01844-352554
 Email: enquiries@maurtron.co.uk

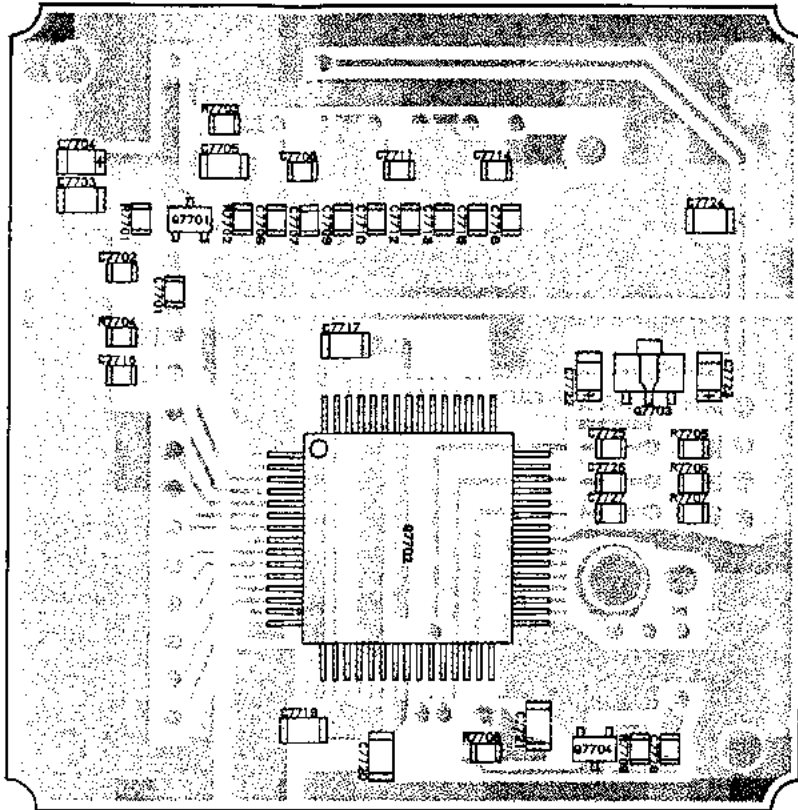

(obverse view of "chip-only" side)

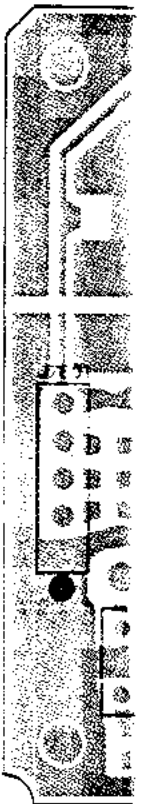

DDS-A UNIT

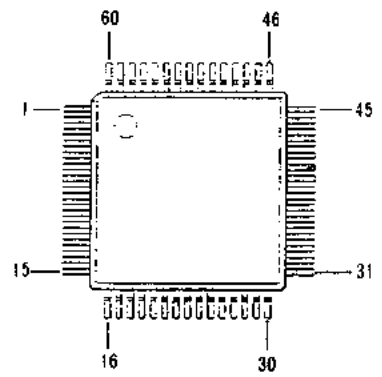
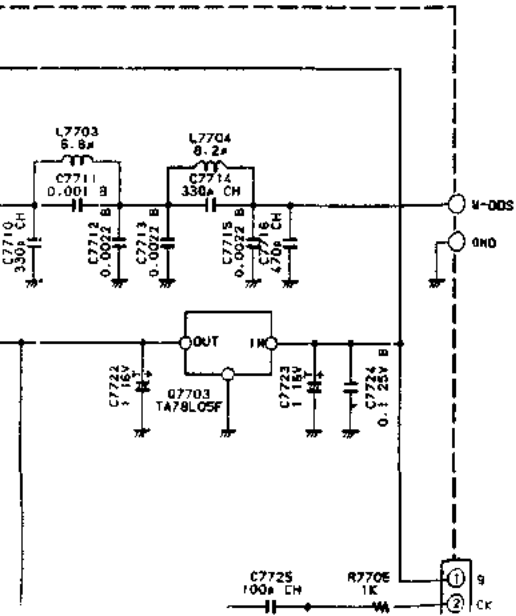

TC23SC030AF
 (Q7702, Q7802)



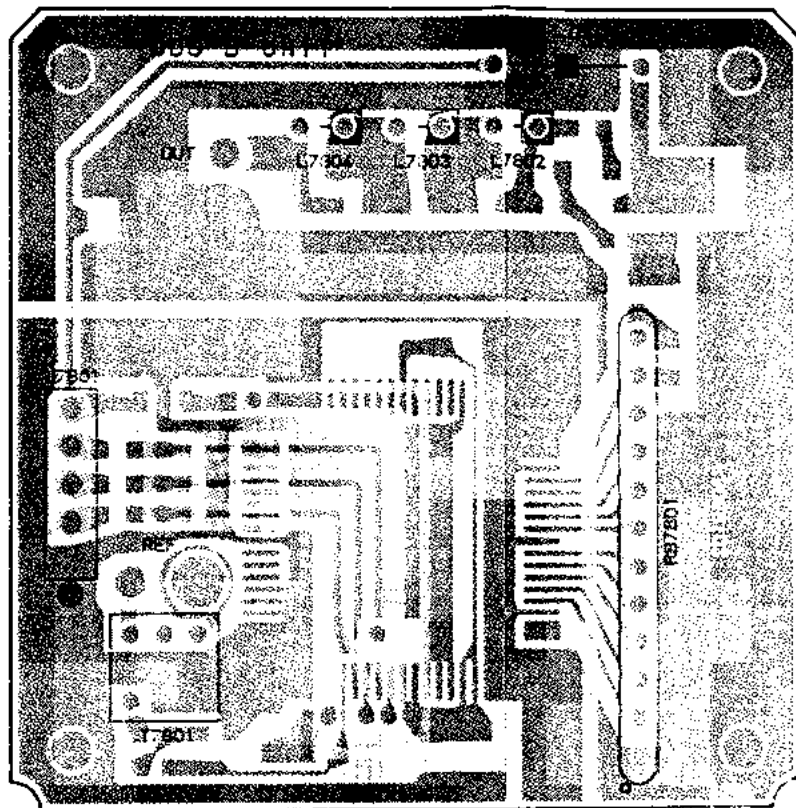

(obverse view of "component" side)

DDS-B UNIT

For Service Manuals Contact
 MAURITRON TECHNICAL SERVICES
 8 Cherry Tree Rd, Chinnor
 Oxon OX9 4QY
 Tel: 01844-351694 Fax: 01844-352554
 Email: enquiries@mauritron.co.uk

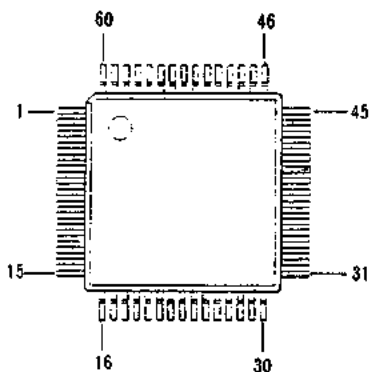

TC23SC030AF
 (Q7702, Q7802)

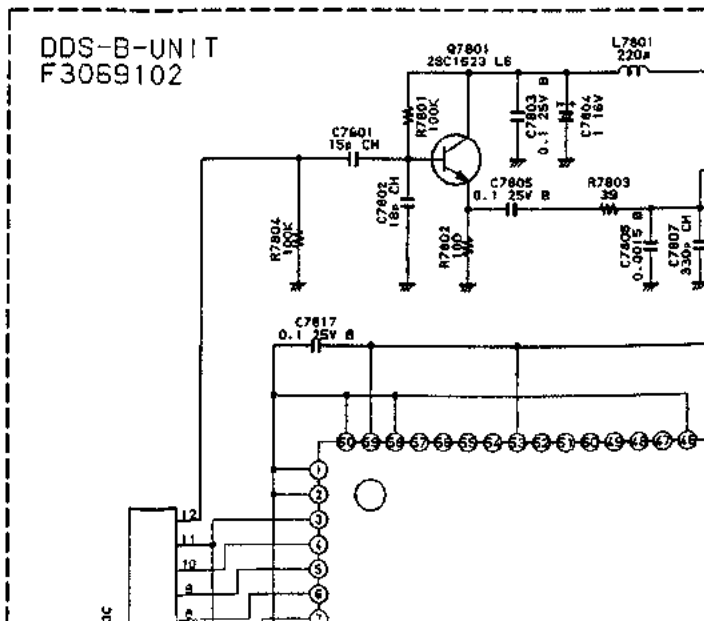

DDS A/B Unit Layout & Schematic

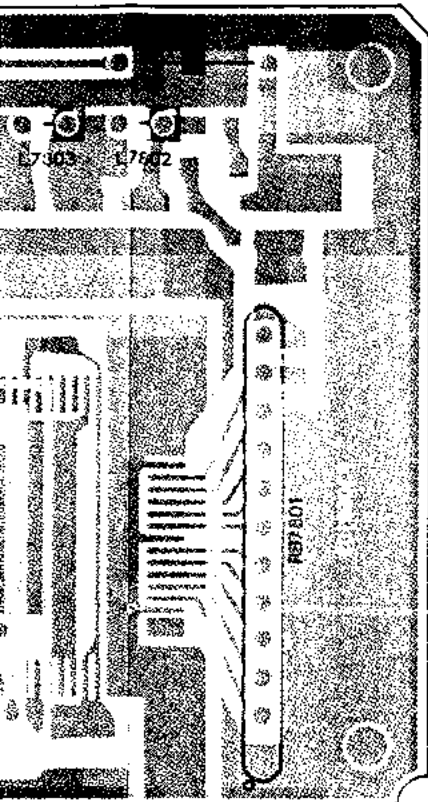

(component side)

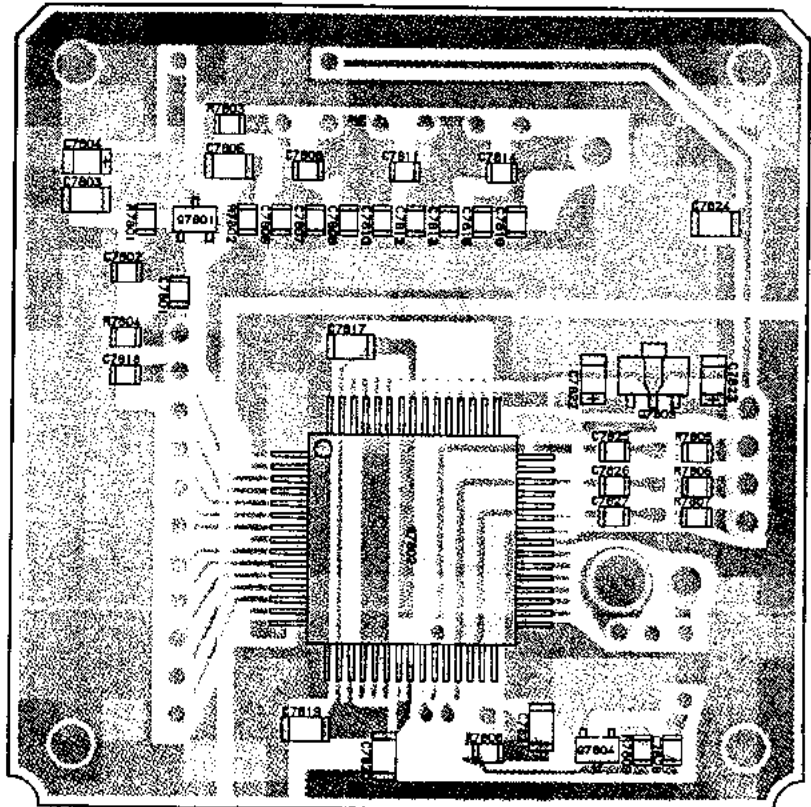

(obverse view of "chip-only" side)

DDS-B UNIT

DDS-B-UNIT
F3069102

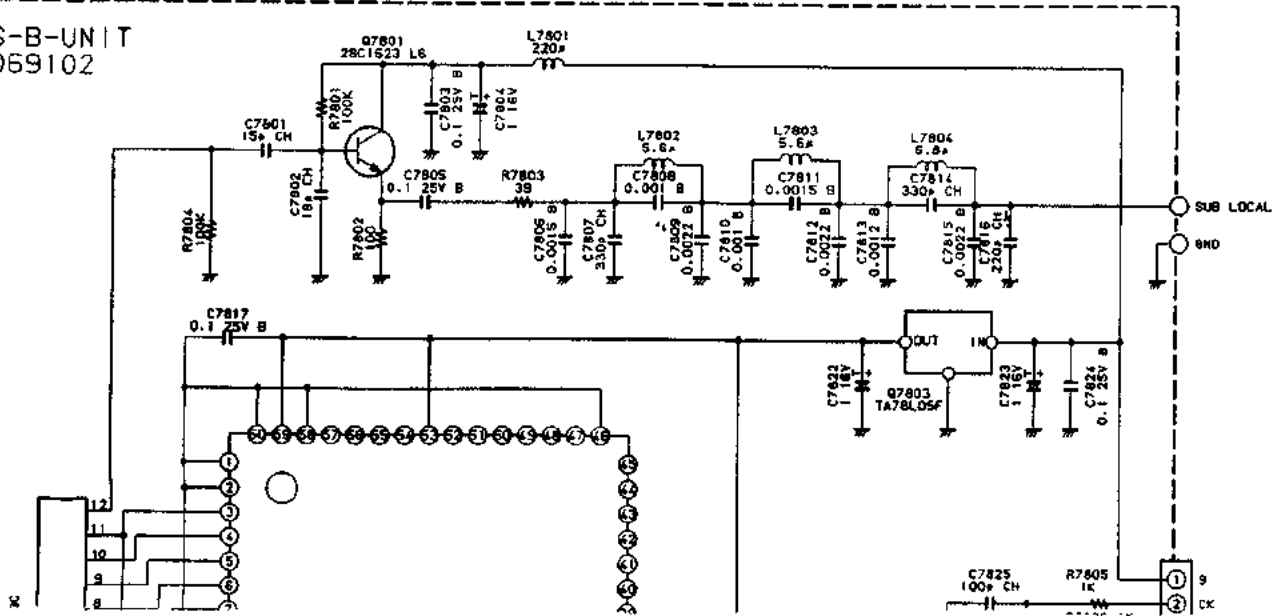



(obverse view of "component" side)



(obverse view of "component" side)

DDS-A UNIT

For Service Manuals Contact
MAURITRON TECHNICAL SERVICES
 8 Cherry Tree Rd, Chinnor
 Oxon OX9 4QY
 Tel: 01844-351694 Fax: 01844-352554
 Email: enquiries@mauritron.co.uk

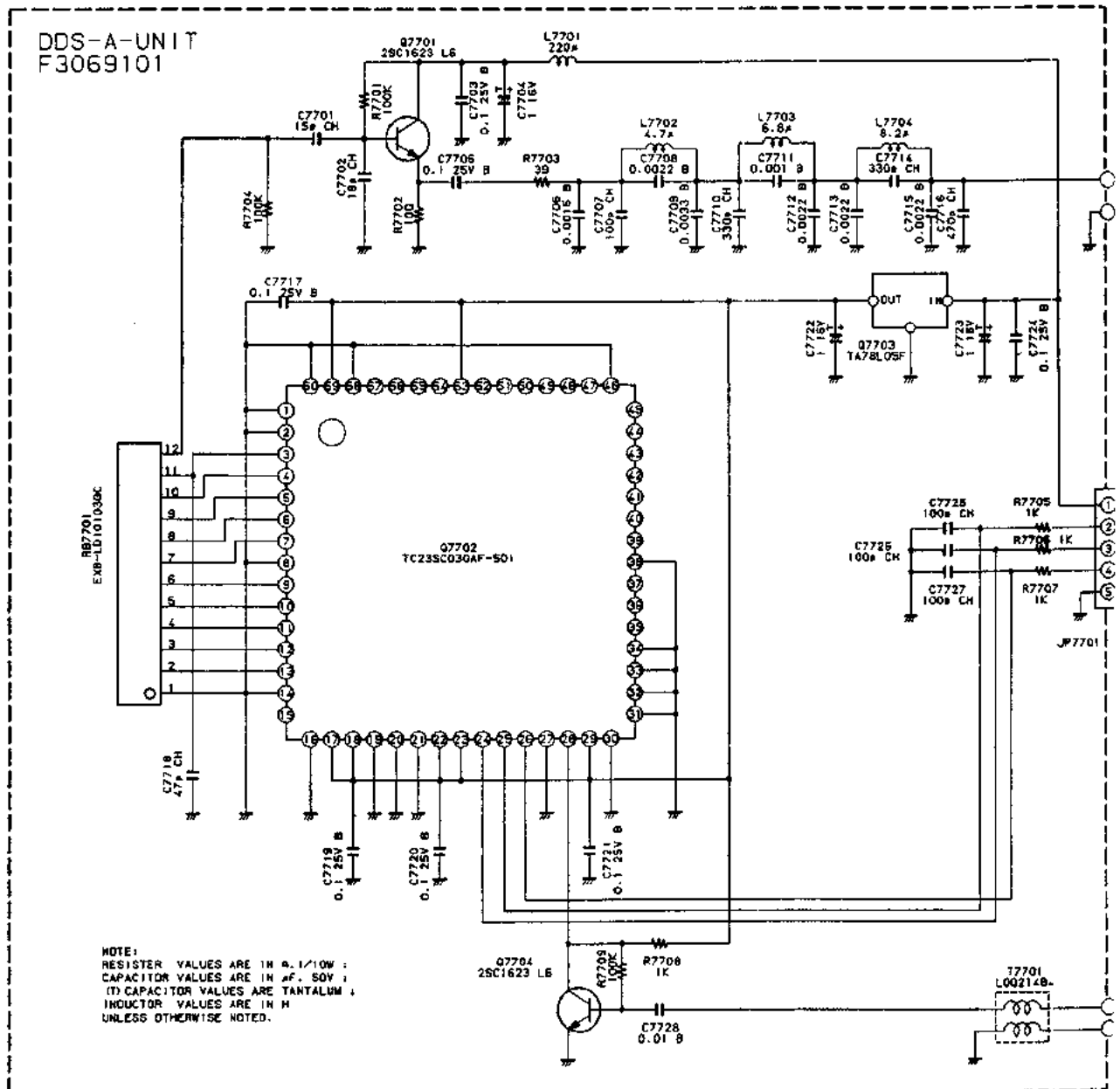

(DDS-A UNIT schematic diagram)



(front side)

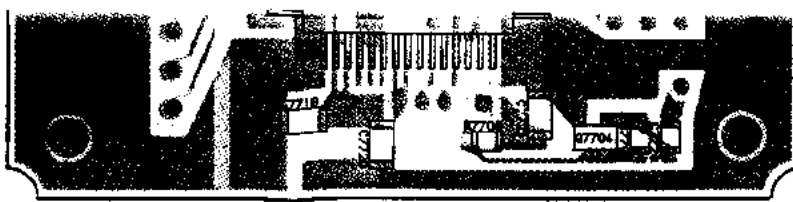

(obverse view of "chip-only" side)

DDS-A UNIT

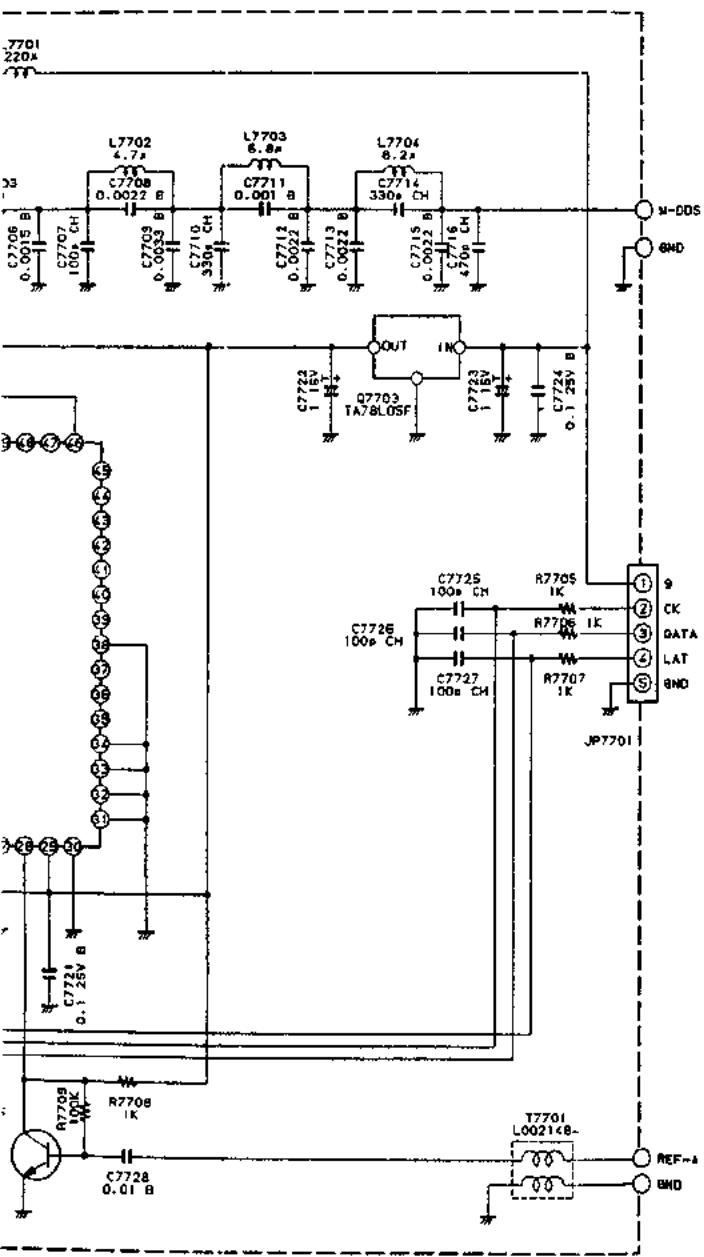

(DDS-A UNIT schematic diagram)

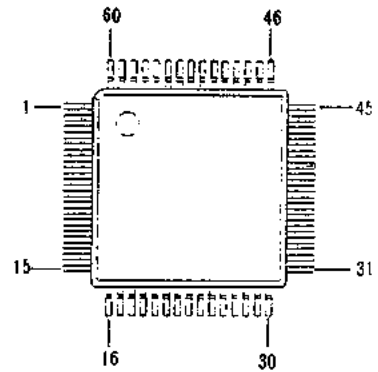

TC23SC030AF
(Q7702, Q7802)

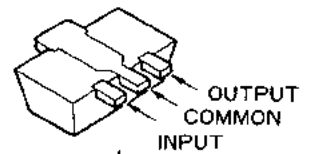

Marked Surface
NJM78L05UA (05)
(Q7703, Q7803)

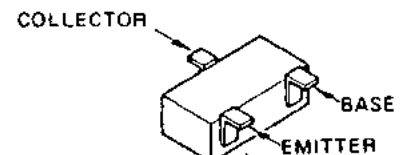

Marked Surface
2SC1623 (L6)
(Q7701, Q7704,
Q7801, Q7804)

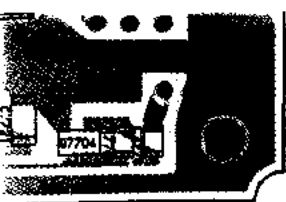

(“component” side)



(obverse view of “component” side)

DDS

For Service Manuals Contact
MAURITRON TECHNICAL SERVICES
 8 Cherry Tree Rd, Chinnor
 Oxon OX9 4QY
 Tel: 01844-351694 Fax: 01844-352554
 Email: engin@maurtron.co.uk

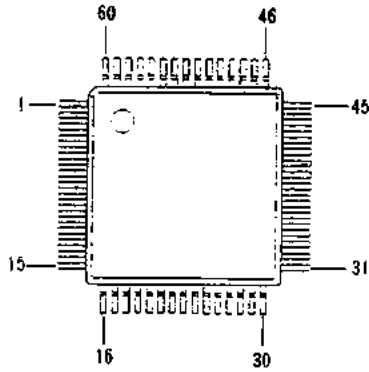

TC23SC030AF
 (Q7702, Q7802)

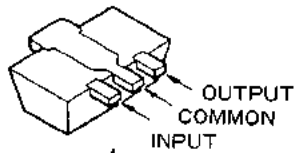

Marked Surface
 NJM78L05UA (05)
 (Q7703, Q7803)

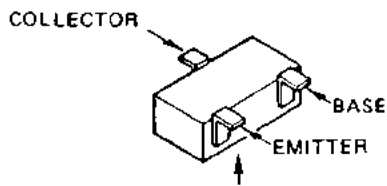

Marked Surface
 2SC1623(L6)
 (Q7701, Q7704,
 Q7801, Q7804)

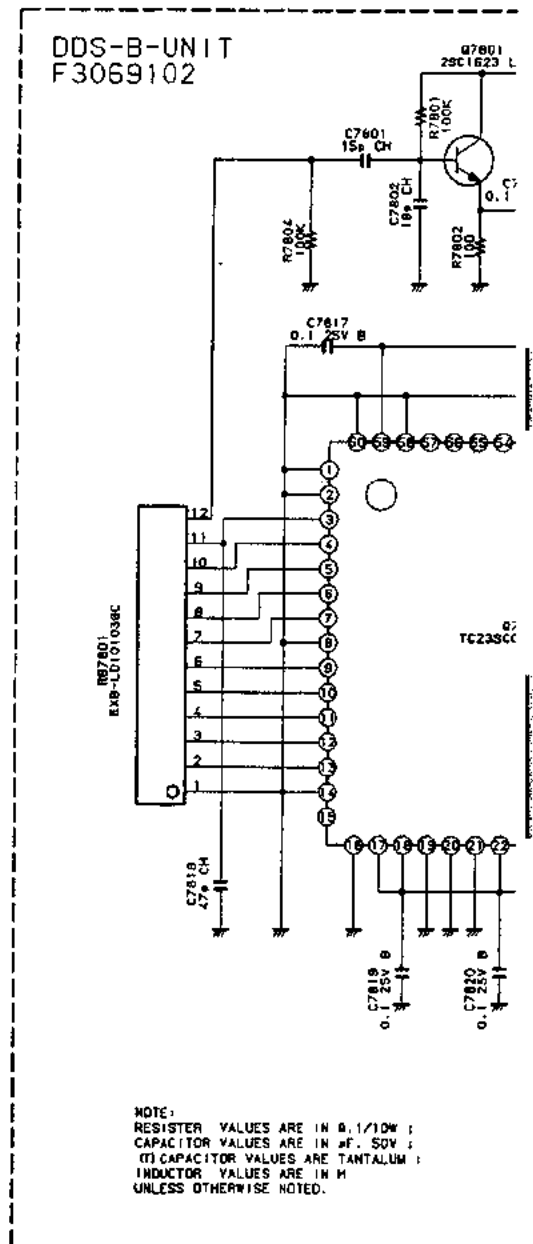

NOTE:
 RESISTOR VALUES ARE IN Ω, 1/10W ;
 CAPACITOR VALUES ARE IN μF, 50V ;
 (T) CAPACITOR VALUES ARE TANTALUM ;
 INDUCTOR VALUES ARE IN mH
 UNLESS OTHERWISE NOTED.



of "component" side)

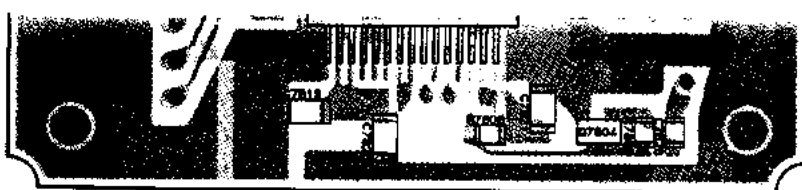

(obverse view of "chip-only" side)

DDS-B UNIT

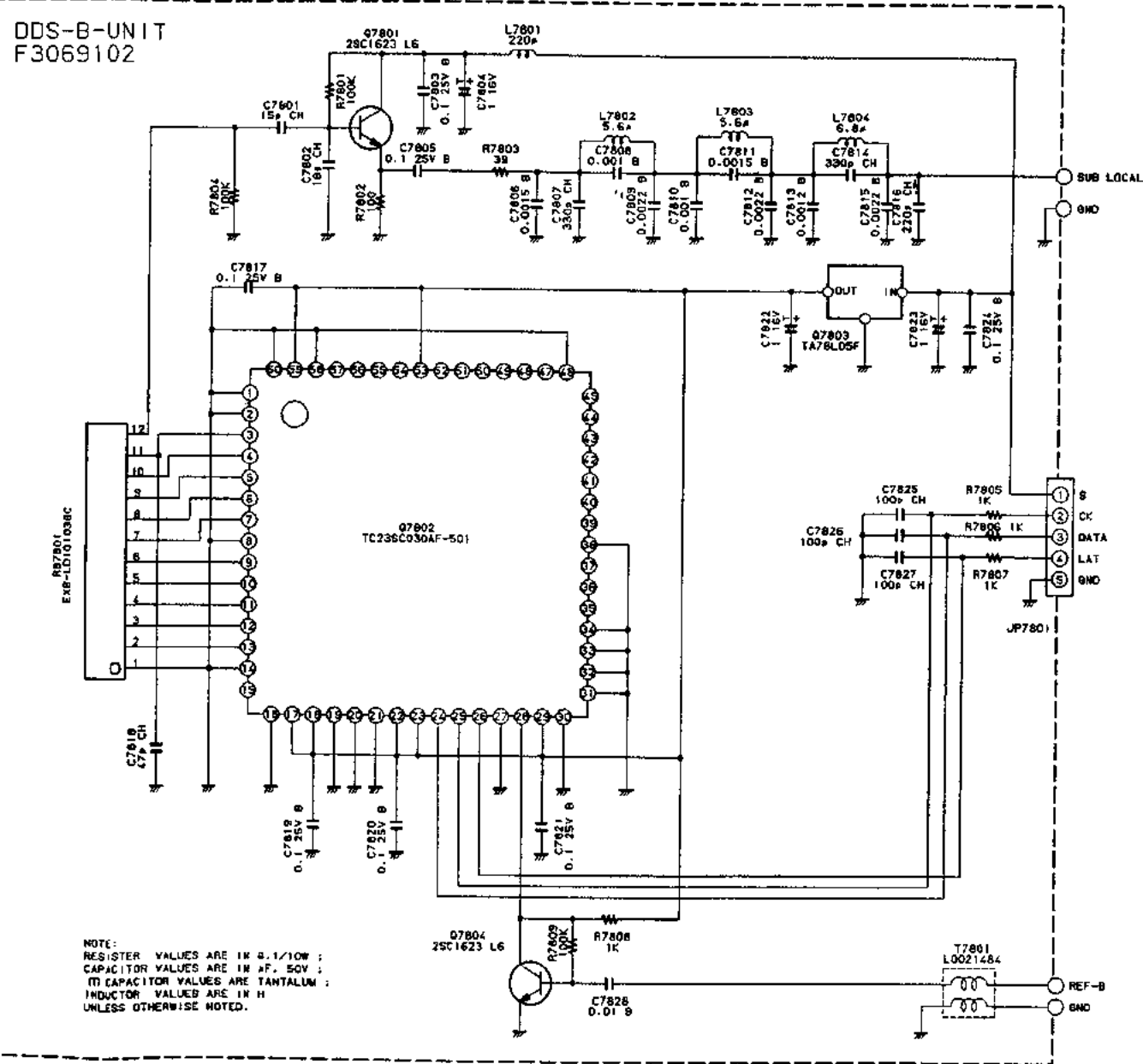

(DDS-B UNIT schematic diagram)

Width/Shift/Mode DDS Unit Parts List

ADD	CODE NO	DESCRIPTION	DEVICE	TYP	VAL
** UNIT NAME : WIDTH-DDS-					
C 4901	K78120013	TANTALUM CHIP CAP.	F951C105MRAAF1Q2	1uF	16V
C 4902	K22170817	CHIP CAP.	GRM40B103M50PT	0.01uF	50V B
C 4903	K78120013	TANTALUM CHIP CAP.	F951C105MRAAF1Q2	1uF	16V
C 4904	K22141809	CHIP CAP.	GRM42-6B104M25PT	0.1uF	25V B
C 4905	K22170805	CHIP CAP.	GRM40B102M50PT	0.001uF	50V B
C 4906	K78120013	TANTALUM CHIP CAP.	F951C105MRAAF1Q2	1uF	16V
C 4907	K22170817	CHIP CAP.	GRM40B103M50PT	0.01uF	50V B
C 4908	K22170235	CHIP CAP.	GRM40CH101J50PT	100pF	50V CH
C 4909	K22170817	CHIP CAP.	GRM40B103M50PT	0.01uF	50V B
C 4910	K78120013	TANTALUM CHIP CAP.	F951C105MRAAF1Q2	1uF	16V
C 4911	K22170817	CHIP CAP.	GRM40B103M50PT	0.01uF	50V B
C 4913	K22170813	CHIP CAP.	GRM40B472M50PT	0.0047uF	50V B
C 4914	K22170815	CHIP CAP.	GRM40B682M50PT	0.0068uF	50V B
C 4915	K22170813	CHIP CAP.	GRM40B472M50PT	0.0047uF	50V B
C 4916	K22171008	CHIP CAP.	GRM40F473Z50PT	0.047uF	50V F
J 4901	P0090092	CONNECTOR	3022-08A		
L 4901	L1790070	M.RFC	LAP02TA101K	100uH	
L 4902	L1790070	M.RFC	LAP02TA101K	100uH	
L 4903	L1190227	M.RFC	LAL03NA561K	560uH	
L 4904	L1190227	M.RFC	LAL03NA561K	560uH	
Q 4901	G1090952	IC	FQ7920(GF77399FS)		
Q 4902	G3327127G	TRANSISTOR	2SC2712GR TE85R		
R 4901	J24205105	CHIP RES.	RMC1/10T 105J	1M	1/10W
R 4902	J24205103	CHIP RES.	RMC1/10T 103J	10K	1/10W
R 4903	J24205101	CHIP RES.	RMC1/10T 101J	100	1/10W
R 4904	J24205473	CHIP RES.	RMC1/10T 473J	47K	1/10W
R 4905	J24205683	CHIP RES.	RMC1/10T 683J	68K	1/10W
R 4906	J24205102	CHIP RES.	RMC1/10T 102J	1K	1/10W
R 4907	J24205471	CHIP RES.	RMC1/10T 471J	470	1/10W
R 4908	J24205471	CHIP RES.	RMC1/10T 471J	470	1/10W
RB4901	J40900170	BLOCK RES. RKM10LG103	RKM10LG103	RKM10LG103	
TP4901	Q5000082	TP-N IPS-1091	TP-N IPS-1091		
TP4902	Q5000082	TP-N IPS-1091	TP-N IPS-1091		
TP4903	Q5000082	TP-N IPS-1091	TP-N IPS-1091		

For Service Manuals Contact
MAURITRON TECHNICAL SERVICES
 8 Cherry Tree Rd, Chinnor
 Oxon OX9 4QY
 Tel: 01844-351694 Fax: 01844-352554
 Email: enquiries@mauriron.co.uk

Width/Shift/Mode DDS Unit Parts List

ADD	CODE NO	DESCRIPTION	DEVICE	TYP	VAL
** UNIT NAME : SHIFT-DDS-					
C 4801	K78120013	TANTALUM CHIP CAP.	F951C105MRAAF1Q2	1uF	16V
C 4802	K22170817	CHIP CAP.	GRM40B103M50PT	0.01uF	50V B
C 4803	K78120013	TANTALUM CHIP CAP.	F951C105MRAAF1Q2	1uF	16V
C 4804	K22141809	CHIP CAP.	GRM42-6B104M25PT	0.1uF	25V B
C 4805	K22170805	CHIP CAP.	GRM40B102M50PT	0.001uF	50V B
C 4806	K78120013	TANTALUM CHIP CAP.	F951C105MRAAF1Q2	1uF	16V
C 4807	K22170817	CHIP CAP.	GRM40B103M50PT	0.01uF	50V B
C 4808	K22170235	CHIP CAP.	GRM40CH101J50PT	100pF	50V CH
C 4809	K22170817	CHIP CAP.	GRM40B103M50PT	0.01uF	50V B
C 4810	K78120013	TANTALUM CHIP CAP.	F951C105MRAAF1Q2	1uF	16V
C 4811	K22170817	CHIP CAP.	GRM40B103M50PT	0.01uF	50V B
C 4813	K22170812	CHIP CAP.	GRM40B392M50PT	0.0039	50V B
C 4814	K22170815	CHIP CAP.	GRM40B682M50PT	0.0068uF	50V B
C 4815	K22170812	CHIP CAP.	GRM40B392M50PT	0.0039	50V B
C 4816	K22171008	CHIP CAP.	GRM40F473Z50PT	0.047uF	50V F
J 4801	P0090092	CONNECTOR	3022-08A		
L 4801	L1790070	M.RFC	LAP02TA101K	100uH	
L 4802	L1790070	M.RFC	LAP02TA101K	100uH	
L 4803	L1190228	M.RFC	LAL03NA681K	680uH	
L 4804	L1190228	M.RFC	LAL03NA681K	680uH	
Q 4801	G1090952	IC	FQ7920(CF77399FS)		
Q 4802	G3327127G	TRANSISTOR	2SC2712GR TR85R		
R 4801	J24205105	CHIP RES.	RMC1/10T 105J	1M	1/10W
R 4802	J24205103	CHIP RES.	RMC1/10T 103J	10K	1/10W
R 4803	J24205101	CHIP RES.	RMC1/10T 101J	100	1/10W
R 4804	J24205473	CHIP RES.	RMC1/10T 473J	47K	1/10W
R 4805	J24205683	CHIP RES.	RMC1/10T 683J	68K	1/10W
R 4806	J24205102	CHIP RES.	RMC1/10T 102J	1K	1/10W
R 4807	J24205471	CHIP RES.	RMC1/10T 471J	470	1/10W
R 4808	J24205471	CHIP RES.	RMC1/10T 471J	470	1/10W
RB4801	J40900170	BLOCK RES. RKM10LG103	RKM10LG103		RKM10LG103
TP4801	Q5000082	TP-N IPS-1091	TP-N IPS-1091		
TP4802	Q5000082	TP-N IPS-1091	TP-N IPS-1091		
TP4803	Q5000082	TP-N IPS-1091	TP-N IPS-1091		

Width/Shift/Mode DDS Unit Parts List

ADD	CODE NO	DESCRIPTION	DEVICE	TYP	VAL
** UNIT NAME : MODE-DDS-U					
C	9701	K22170817	CHIP CAP.	GRM40B103M50PT	0.01uF 50V B
C	9702	K78120013	TANTALUM CHIP CAP.	F951C105MRAAF1Q2	1uF 16V
C	9703	K22171008	CHIP CAP.	GRM40F473Z50PT	0.047uF 50V F
C	9704	K22141809	CHIP CAP.	GRM42-6B104M25PT	0.1uF 25V B
C	9705	K78120013	TANTALUM CHIP CAP.	F951C105MRAAF1Q2	1uF 16V
C	9706	K22171008	CHIP CAP.	GRM40F473Z50PT	0.047uF 50V F
C	9707	K78120013	TANTALUM CHIP CAP.	F951C105MRAAF1Q2	1uF 16V
C	9708	K22170817	CHIP CAP.	GRM40B103M50PT	0.01uF 50V B
C	9709	K22171008	CHIP CAP.	GRM40F473Z50PT	0.047uF 50V F
C	9710	K78120013	TANTALUM CHIP CAP.	F951C105MRAAF1Q2	1uF 16V
C	9712	K22170805	CHIP CAP.	GRM40B102M50PT	0.001uF 50V B
C	9713	K22170807	CHIP CAP.	GRM40B152M50PT	0.0015 50V B
C	9714	K22170805	CHIP CAP.	GRM40B102M50PT	0.001uF 50V B
C	9715	K22171008	CHIP CAP.	GRM40F473Z50PT	0.047uF 50V F
C	9716	K22170235	CHIP CAP.	GRM40CH101J50PT	100pF 50V CH
J	9701	P0090352	CONNECTOR	3022-03A	
L	9701	L1790070	M.RFC	LAP02TA101K	100uH
L	9702	L1790070	M.RFC	LAP02TA101K	100uH
L	9703	L1790070	M.RFC	LAP02TA101K	100uH
L	9704	L1790070	M.RFC	LAP02TA101K	100uH
Q	9701	G1090952	IC	FQ7920(CF77399FS)	
Q	9702	G3327127G	TRANSISTOR	2SC2712GR TE85R	
R	9701	J24205105	CHIP RES.	RMC1/10T 105J	1M 1/10W
R	9702	J24205104	CHIP RES.	RMC1/10T 104J	100K 1/10W
R	9703	J24205101	CHIP RES.	RMC1/10T 101J	100 1/10W
R	9704	J24205473	CHIP RES.	RMC1/10T 473J	47K 1/10W
R	9705	J24205683	CHIP RES.	RMC1/10T 683J	68K 1/10W
R	9706	J24205471	CHIP RES.	RMC1/10T 471J	470 1/10W
R	9707	J24205471	CHIP RES.	RMC1/10T 471J	470 1/10W
R	9708	J24205471	CHIP RES.	RMC1/10T 471J	470 1/10W
RB9701	J40900170	BLOCK RES. RKM10LG103		RKM10LG103	RKM10LG103
TP9701	Q5000082	TP-N IPS-1091		TP-N IPS-1091	
TP9702	Q5000082	TP-N IPS-1091		TP-N IPS-1091	
TP9703	Q5000082	TP-N IPS-1091		TP-N IPS-1091	

For Service Manuals Contact
MAURITRON TECHNICAL SERVICES
 8 Cherry Tree Rd, Chinnor
 Oxon OX9 4QY
 Tel:- 01844-351894 Fax:- 01844-352554
 Email:- enquiries@mauriron.co.uk

For Service Manuals Contact
MAURITRON TECHNICAL SERVICES
8 Cherry Tree Rd. Chinnor
Oxon OX9 4QY
Tel: 01844-351694 Fax: 01844-352554
Email: enquiries@mauriton.co.uk

For Service Manuals Contact
 MAURITRON TECHNICAL SERVICES
 8 Cherry Tree Rd, Chinnor
 Oxon OX9 4QY
 Tel: 01844-351694 Fax: 01844-352554
 Email: enquiries@mauritron.co.uk

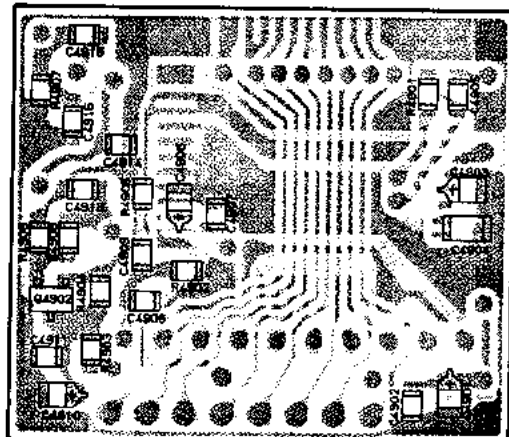
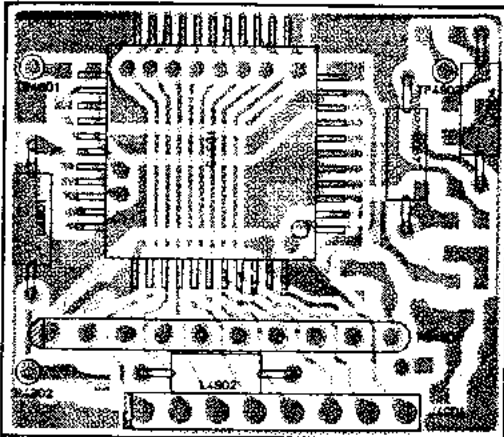

(obverse view of "component" side)

(obverse view of "chip-only" side)

WIDTH DDS UNIT

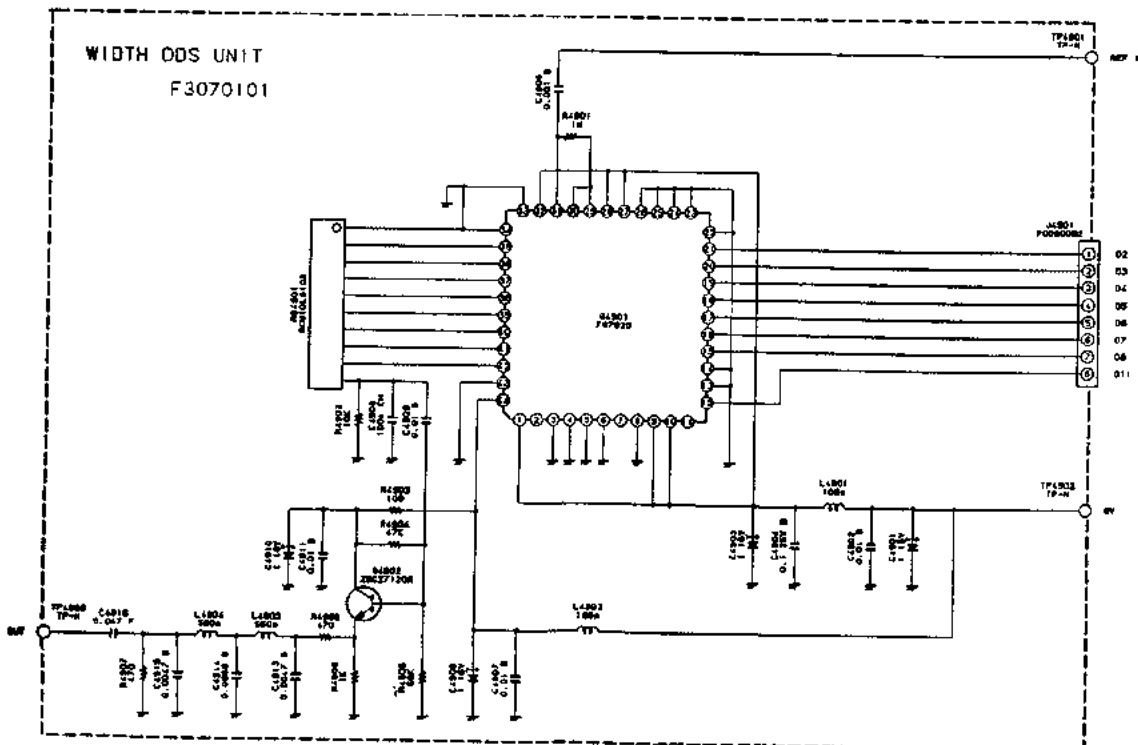

(WIDTH DDS UNIT schematic diagram)

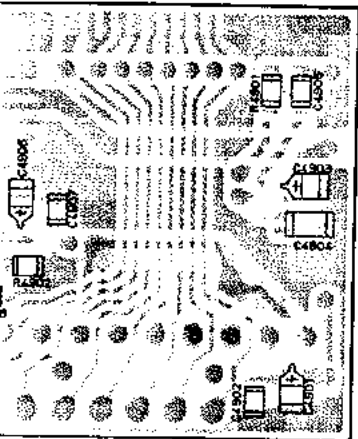

(view of "chip-only" side)

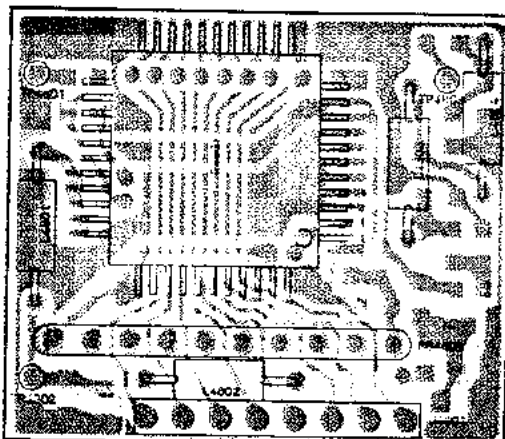

(obverse view of "component" side)

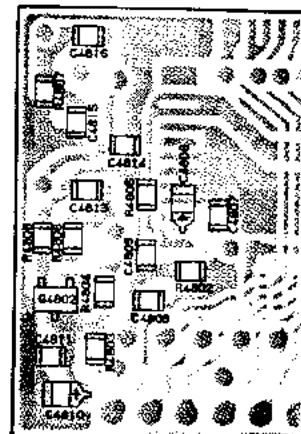

(obverse view of "component" side)

SHIFT DDS UNIT

For Service Manuals Contact
MAURITRON TECHNICAL SERVICES
 8 Cherry Tree Rd, Chinnor
 Oxon OX9 4QY
 Tel: 01844-351694 Fax: 01844-352554
 Email: enquiries@mauritron.co.uk

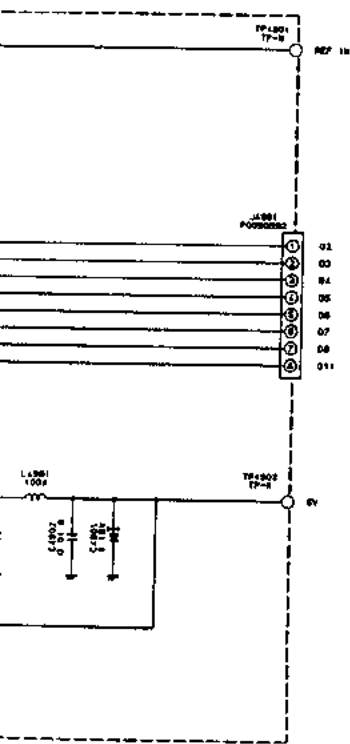

(schematic diagram)

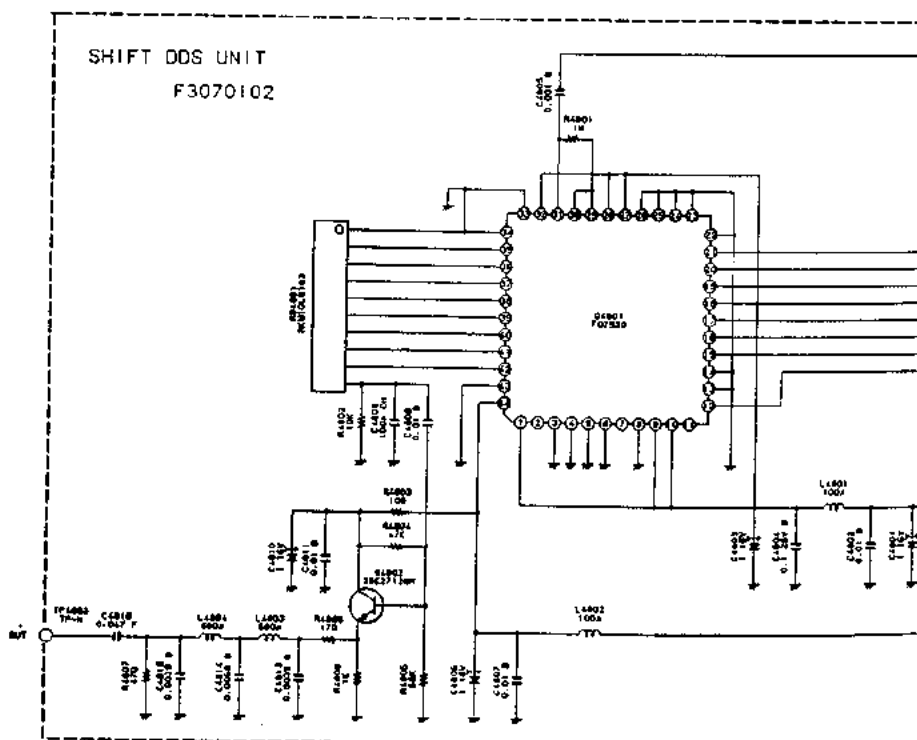

NOTE:
 RESISTOR VALUES ARE IN Ω, K/1000
 CAPACITOR VALUES ARE IN pF/1000

(SHIFT DDS UNIT schematic)

Width/Shift/Mode DDS Unit

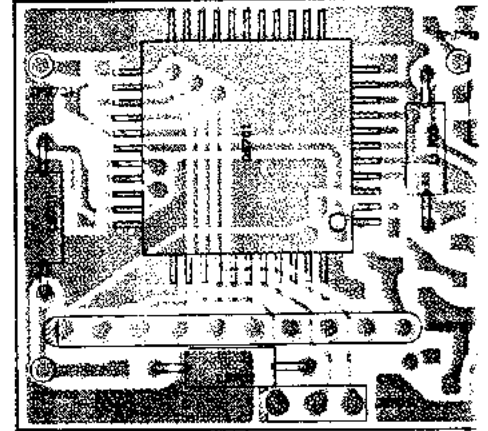
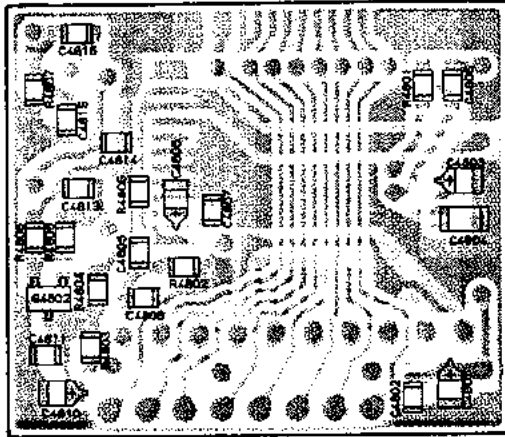
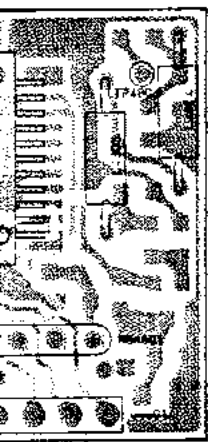

(“component” side)

(obverse view of “chip-only” side)

(obverse view of “component” side)

SHIFT DDS UNIT

MOE

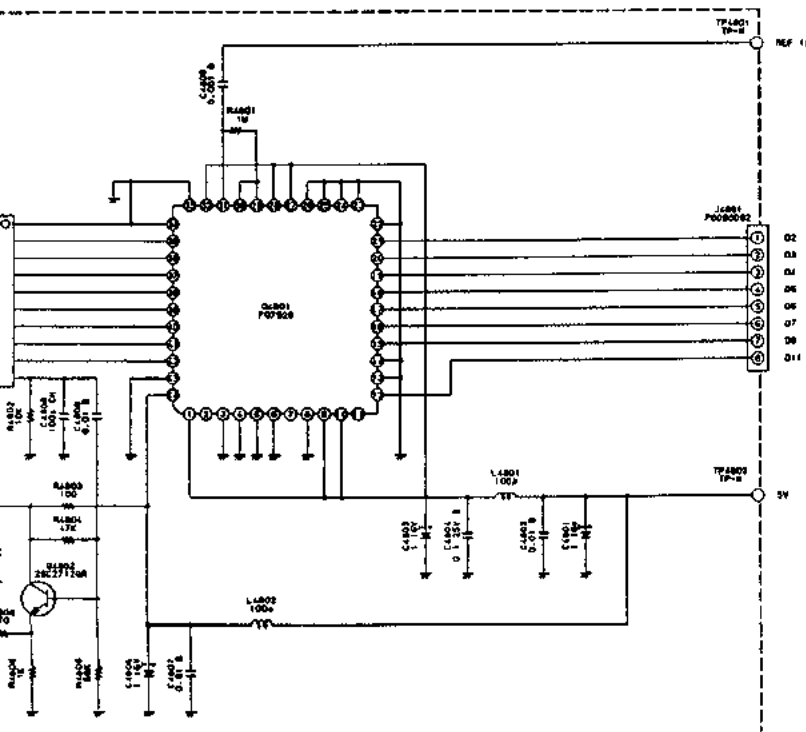

(SHIFT DDS UNIT schematic diagram)

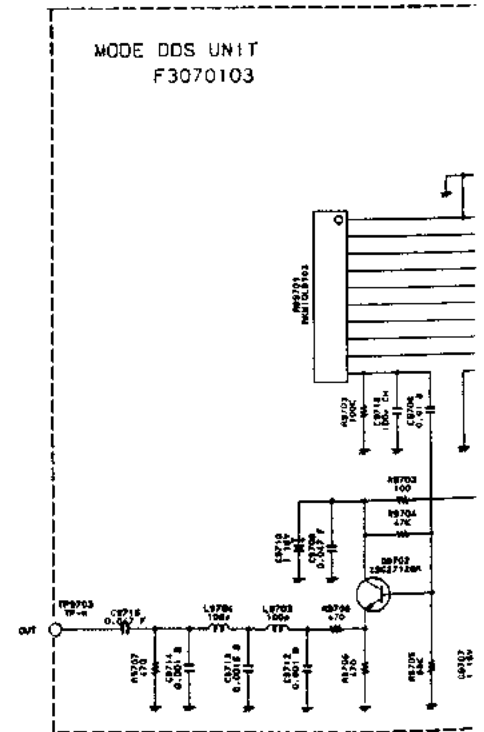

(MODE DDS UNIT schematic diagram)

n/Shift/Mode DDS Unit Layout & Schematic Diagram

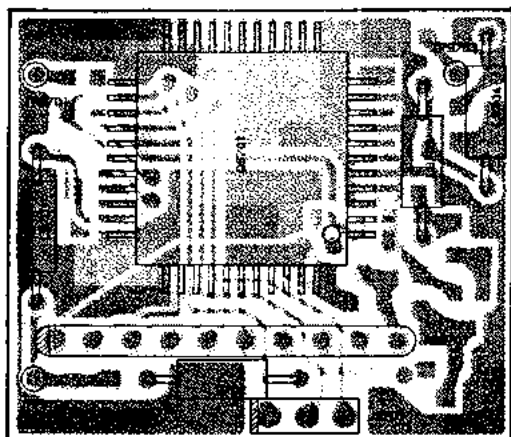

(obverse view of "component" side)

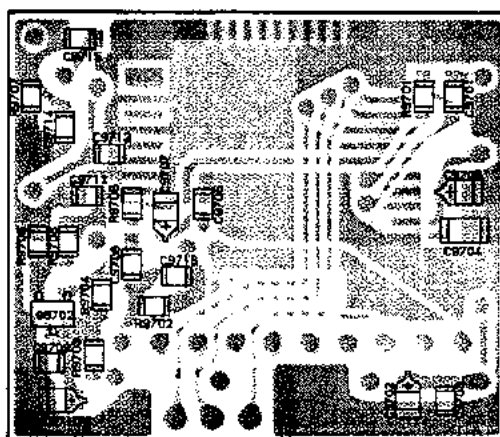

(obverse view of "chip-only" side)

MODE DDS UNIT

For Service Manuals Contact
MAURITRON TECHNICAL SERVICES
 8 Cherry Tree Rd, Chinnor
 Oxon OX9 4QY
 Tel:- 01844-351634 Fax:- 01844-352554
 Email:- enquiries@mauritron.co.uk

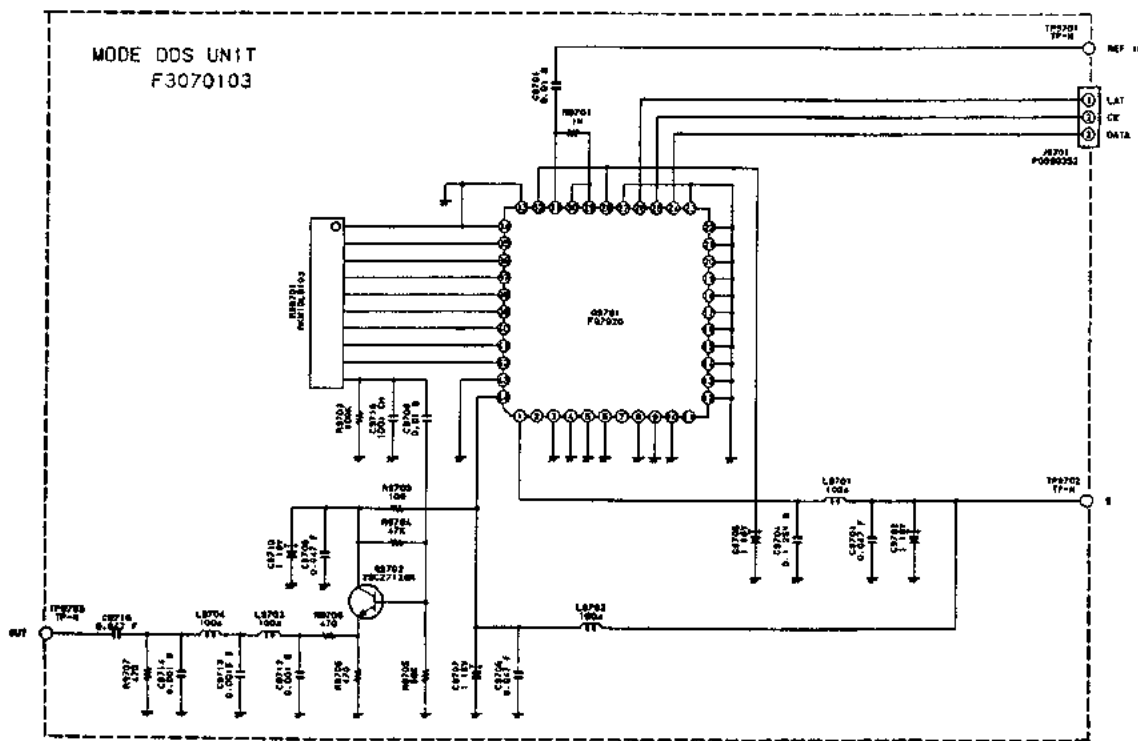

(MODE DDS UNIT schematic diagram)

WIDTH DDS UNIT

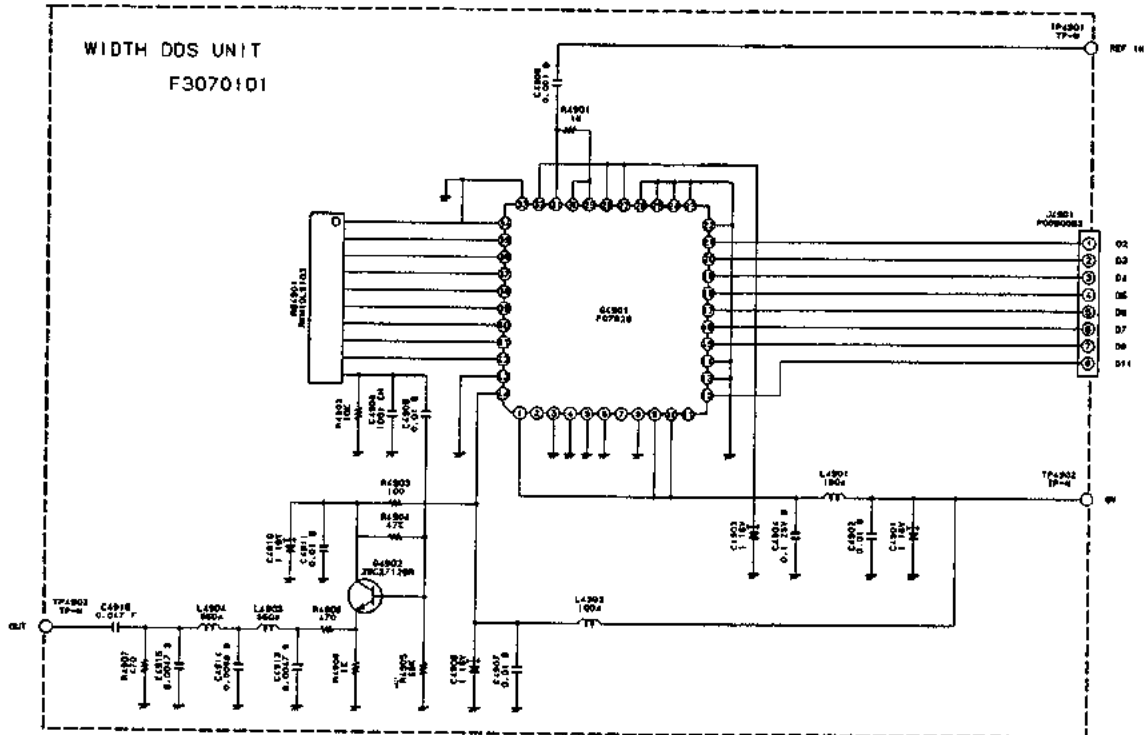

NOTE:
RESISTOR VALUES ARE IN Ω, k/1000,
CAPACITOR VALUES ARE IN pF, nF, μF.
IF CAPACITOR VALUES ARE TANTALUM,
IF CAPACITOR VALUES ARE IN μF
INDUCTOR VALUES ARE IN μH
UNLESS OTHERWISE NOTED.

(WIDTH DDS UNIT schematic diagram)

view of "chip-only" side)

(obverse view of "component" side) (obverse view of

SHIFT DDS UNIT

For Service Manuals Contact
MAURITRON TECHNICAL SERVICES
8 Cherry Tree Rd, Chinnor
Oxon OX9 4QY
Tel: 01844-351694 Fax: 01844-352554
Email: enquiries@mauritron.co.uk

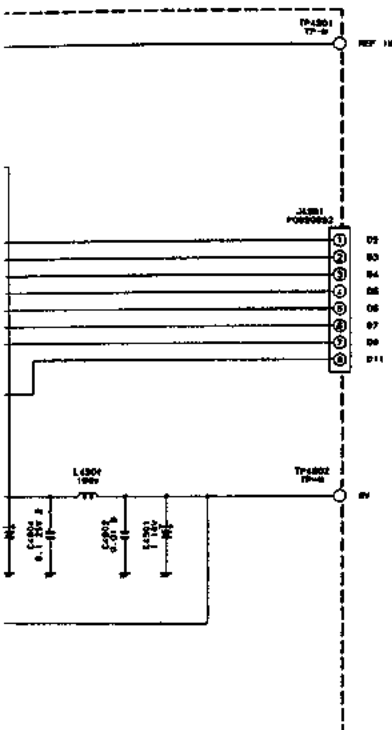

IIIT schematic diagram)

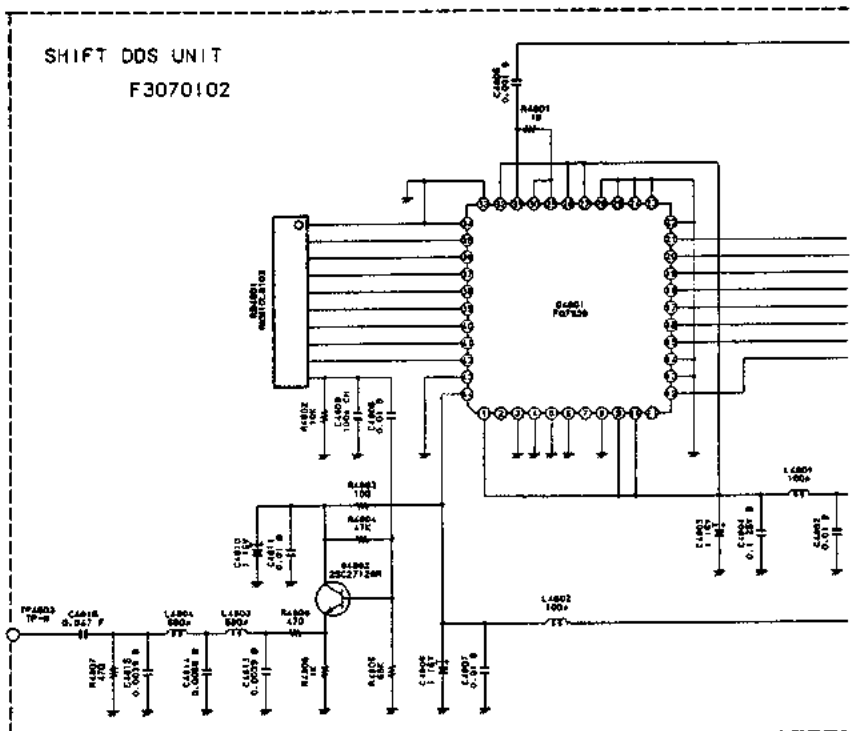

(SHIFT DDS UNIT scher

NOTE:
RESISTOR VALUES ARE IN Ω , k Ω OR Ω
CAPACITOR VALUES ARE IN pF, nF, μ F, OR μ F
(*) CAPACITOR VALUES ARE TANTALUM
INDUCTOR VALUES ARE IN μ H
UNLESS OTHERWISE NOTED.

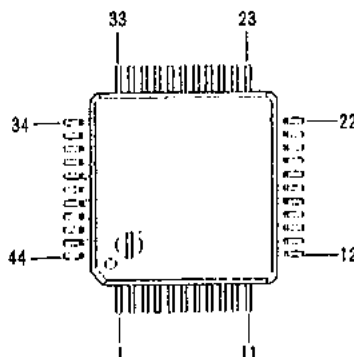

F07920
(Q4801, Q4901, Q9701)

of "component" side) (obverse view of "chip-only" side)

(obverse view of "compone

SHIFT DDS UNIT

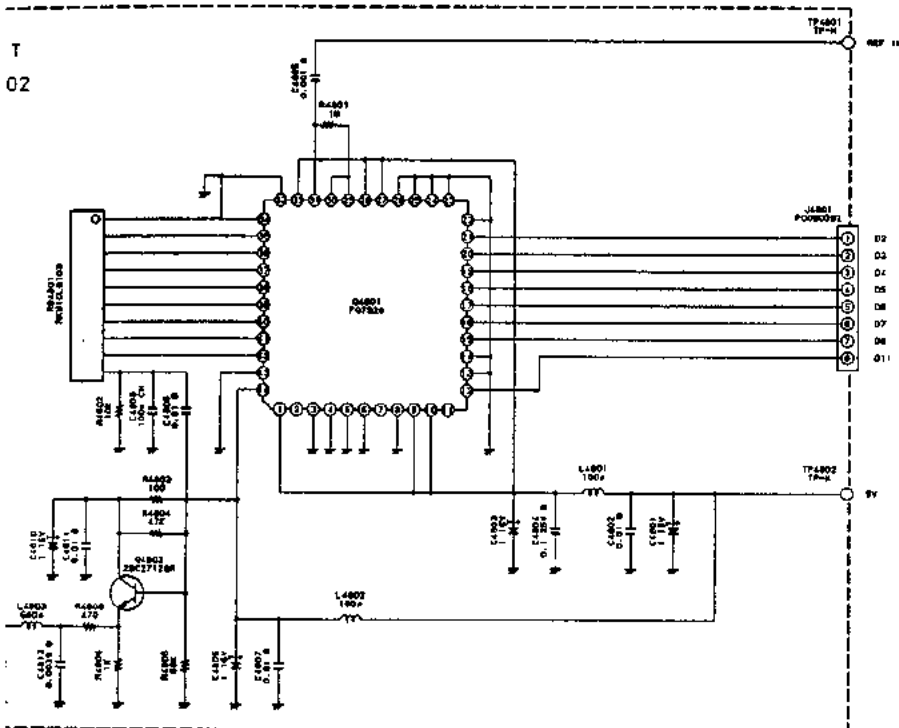

(SHIFT DDS UNIT schematic diagram)

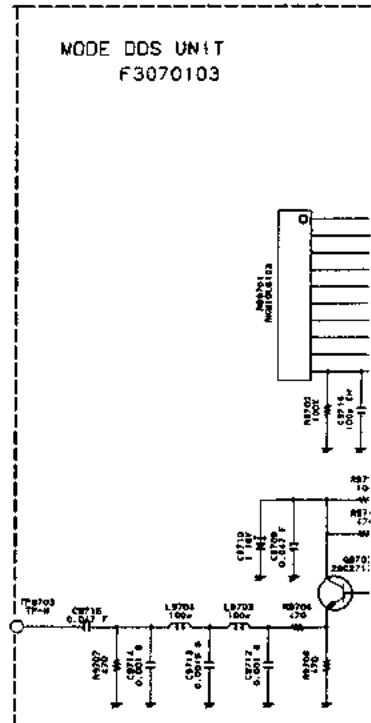

NOTE:
RESISTOR VALUES ARE IN K, Ω, M;
CAPACITOR VALUES ARE IN P, μF, nF;
Ω CAPACITOR VALUES ARE PARTIAL;
INDUCTOR VALUES ARE IN μH
UNLESS OTHERWISE NOTED.

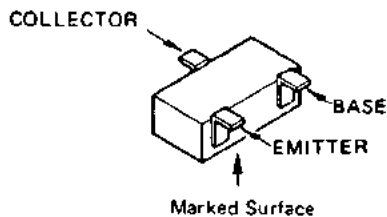
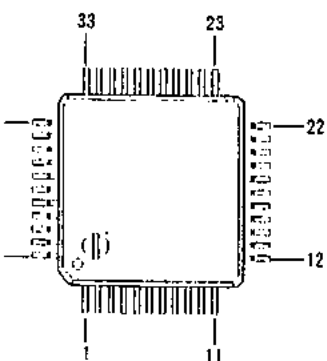

F07920
(Q4801, Q4901, Q9701)

25C2712GR(LG)
(Q4802, Q4902, Q9702)

(obverse view of "component" side) (obverse view of "chip-only" side)

MODE DDS UNIT

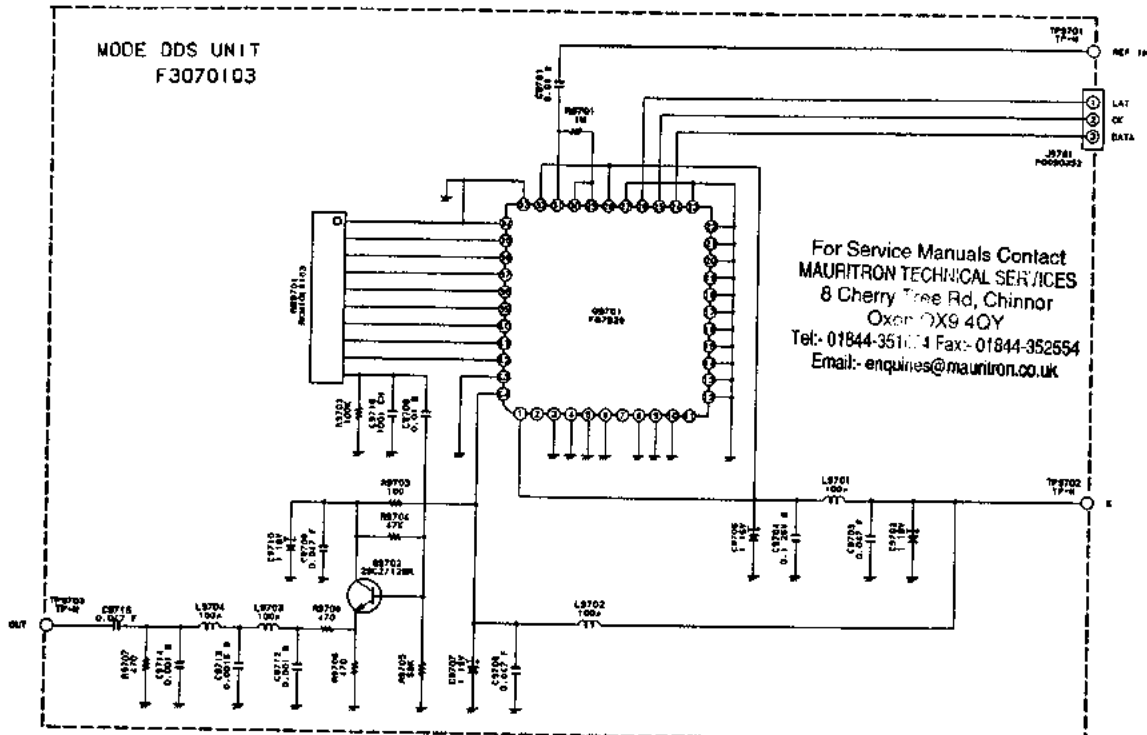

(MODE DDS UNIT schematic diagram)

Reference (REF) Unit Parts List

ADD	CODE NO	DESCRIPTION	DEVICE			TYP VAL
** UNIT NAME : REF-UNIT						
C	7901	K26170657 CERAMIC CAP.	DD106-979F103Z50	0.01uF	50V	F
C	7902	K46140005 AL.ELECTRO.CAP.	25V101M6X11TR5	100uF	25V	
C	7903	K26171005 CERAMIC CAP.	DD104-979SL100D50	10pF	50V	SL
C	7904	K26171021 CERAMIC CAP.	DD104-979SL470J50	47pF	50V	SL
C	7905	K46140005 AL.ELECTRO.CAP.	25V101M6X11TR5	100uF	25V	
C	7906	K26170657 CERAMIC CAP.	DD106-979F103Z50	0.01uF	50V	F
C	7907	K26170657 CERAMIC CAP.	DD106-979F103Z50	0.01uF	50V	F
C	7908	K46140005 AL.ELECTRO.CAP.	25V101M6X11TR5	100uF	25V	
C	7909	K26170657 CERAMIC CAP.	DD106-979F103Z50	0.01uF	50V	F
C	7910	K26171608 CERAMIC CAP.	DD104-979B331K50	330pF	50V	B
C	7911	K26171611 CERAMIC CAP.	DD104-979B561K50	560pF	50V	B
C	7912	K26171608 CERAMIC CAP.	DD104-979B331K50	330pF	50V	B
C	7913	K26170657 CERAMIC CAP.	DD106-979F103Z50	0.01uF	50V	F
J	7901	P0090622 CONNECTOR	SC25-03WS			
L	7901	L1790128 M.RFC	LAL03VB1R0M	1uH		
L	7902	L1790128 M.RFC	LAL03VB1R0M	1uH		
Q	7901	G3801921G FET	2SK192AGR			
Q	7902	G3305354B TRANSISTOR	2SC535BTZ			
R	7901	J06245470 CARBON FILM RES.	RD25UJ470T 47	47		1/4W
R	7902	J06245223 CARBON FILM RES.	RD25UJ223T 22K	22K		1/4W
R	7903	J06245223 CARBON FILM RES.	RD25UJ223T 22K	22K		1/4W
R	7904	J06245681 CRABON FILM RES.RD25UJ681T 680	RD25UJ681T 680	680		1/4W
R	7905	J06245470 CARBON FILM RES.	RD25UJ470T 47	47		1/4W
R	7906	J06245223 CARBON FILM RES.	RD25UJ223T 22K	22K		1/4W
R	7907	J06245223 CARBON FILM RES.	RD25UJ223T 22K	22K		1/4W
R	7908	J06245471 CARBON FILM RES.	RD25UJ471T 470	470		1/4W
R	7909	J06245470 CARBON FILM RES.	RD25UJ470T 47	47		1/4W
TP	7901	Q5000026 TP-F	TP-F IPS-1032			
X	7901	H9500140 XTAL	GF-1031 10.48576			

TCO 1031

For Service Manuals Contact
MAURITRON TECHNICAL SERVICES
8 Cherry Tree Rd, Chinnor
Oxon OX9 4QY
Tel: 01844-351634 Fax: 01844-352554
Email: enquiries@mauritron.co.uk

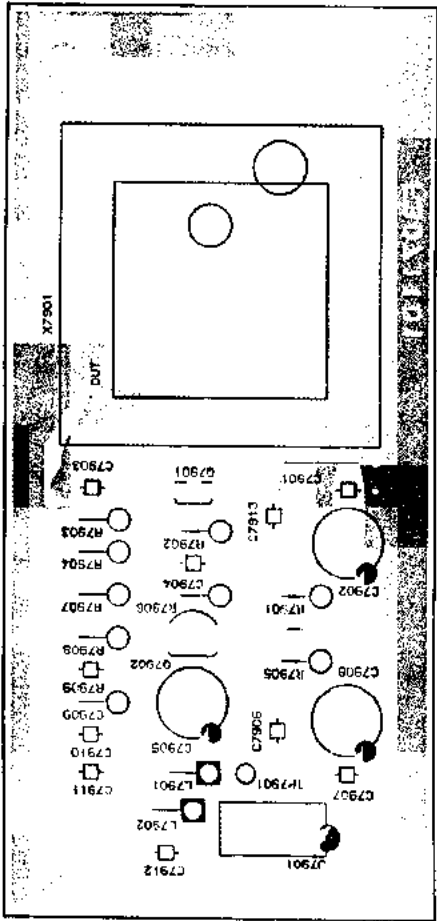

(obverse view of "component" side)

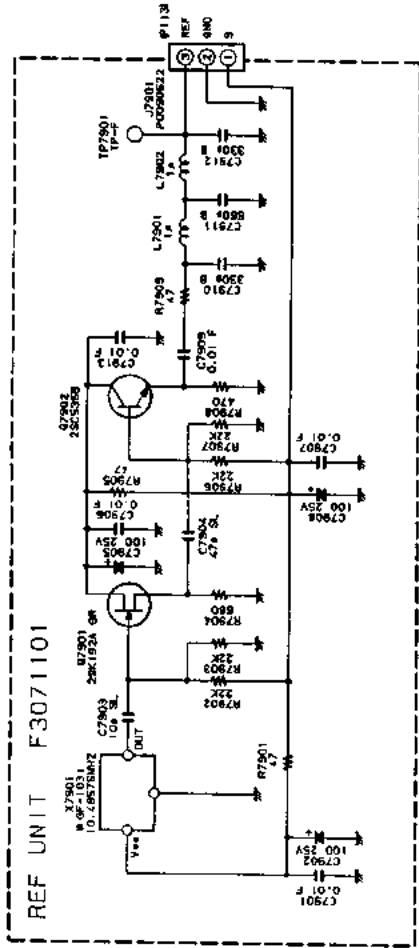

(schematic diagram)

NOTE:
RESISTOR VALUES ARE IN Ω , 1/10 Ω ,
100 Ω , 1K, 10K, 100K, 1M, ∞ .
CAPACITOR VALUES ARE IN pF, 500 pF,
1n, 10n, 100n, 1 μ , 10 μ , 100 μ ,
UNLESS OTHERWISE NOTED.

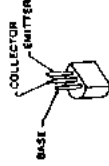

2SD5356BTZ
(07902)

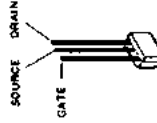

2SK192AGR
(07901)

For Service Manuals Contact
MAURITRON TECHNICAL SERVICES
8 Cherry Tree Rd, Chinnor
Oxon OX9 4QY
Tel: 01844-351694 Fax: 01844-352554
Email: enquiries@mauritron.co.uk

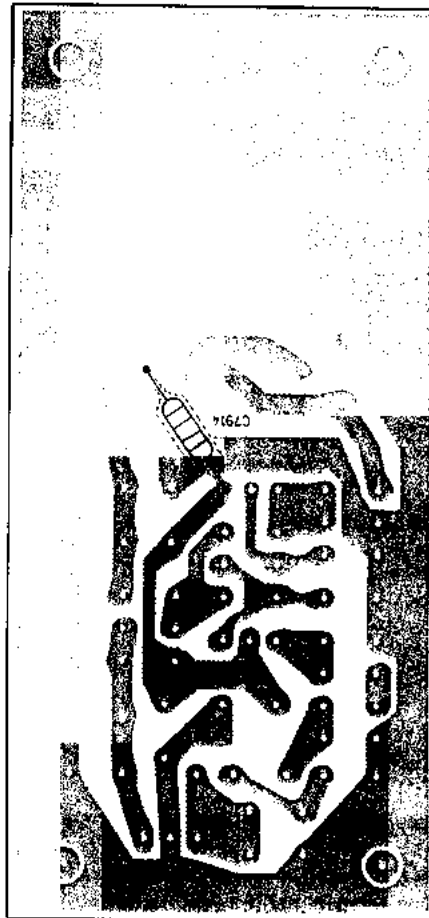

(obverse view of "chip-only" side)

Display Unit Parts List

ADD	CODE NO	DESCRIPTION	DEVICE	TYP	VAL
** UNIT NAME : DISPLAY-UN					
C	8001	K26170657 CERAMIC CAP.	DD106-979F103Z50	0.01uF	50V F
C	8002	K26170185 CERAMIC CAP.DD104-979CH180J50	DD104-979CH180J50	18pF	50V CH
C	8003	K26170185 CERAMIC CAP.DD104-979CH180J50	DD104-979CH180J50	18pF	50V CH
C	8004	K26170657 CERAMIC CAP.	DD106-979F103Z50	0.01uF	50V F
C	8005	K26170657 CERAMIC CAP.	DD106-979F103Z50	0.01uF	50V F
C	8006	K46120004 AL.ELECTRO.CAP.	16V100M4X7TR2	10uF	16V
C	8007	K46120004 AL.ELECTRO.CAP.	16V100M4X7TR2	10uF	16V
C	8008	K12279001 CERAMIC CAP.	ECKD2H102PE	0.001uF	500V E
C	8009	K40189001 AL.ELECTRO.CAP.	RE-63V470M	47UF	63V
C	8010	K46120004 AL.ELECTRO.CAP.	16V100M4X7TR2	10uF	16V
C	8011	K50170011 FILM CAP. 50F2D472M	50F2D472M	0.0047	50V
C	8012	K26170657 CERAMIC CAP.	DD106-979F103Z50	0.01uF	50V F
C	8013	K46120007 AL.ELECTRO.CAP.	16V101M6X7TR2	100uF	16V
C	8014	K26170657 CERAMIC CAP.	DD106-979F103Z50	0.01uF	50V F
C	8015	K26170657 CERAMIC CAP.	DD106-979F103Z50	0.01uF	50V F
C	8016	K46160006 AL.ELECTRO.CAP.	35V220M6X7TR2	22uF	35V
C	8018	K46120004 AL.ELECTRO.CAP.	16V100M4X7TR2	10uF	16V
D	8001	G2090153 DIODE	RD10EB1		
D	8002	G2090340 DIODE	1SS83		
D	8003	G2090257 DIODE	RD33EB1		
D	8004	G2090340 DIODE	1SS83		
D	8005	G2090463 DIODE	RD5.1EB1		
D	8006	G2050010 LED	LT3P44D		
D	8007	G2050011 LED	LT3N44D		
D	8008	G2050011 LED	LT3N44D		
D	8009	G2050010 LED	LT3P44D		
D	8010	G2050012 LED	LT3S44D		
D	8011	G2050011 LED	LT3N44D		
D	8012	G2060004 DIODE	1SS270TJ		
D	8013	G2060004 DIODE	1SS270TJ		
D	8014	G2060004 DIODE	1SS270TJ		
D	8015	G2060004 DIODE	1SS270TJ		
D	8016	G2060004 DIODE	1SS270TJ		
D	8017	G2060004 DIODE	1SS270TJ		
D	8018	G2060004 DIODE	1SS270TJ		
D	8019	G2060004 DIODE	1SS270TJ		
D	8020	G2060004 DIODE	1SS270TJ		
D	8021	G2060004 DIODE	1SS270TJ		
D	8022	G2060004 DIODE	1SS270TJ		
D	8023	G2060004 DIODE	1SS270TJ		
D	8024	G2060004 DIODE	1SS270TJ		
D	8025	G2060004 DIODE	1SS270TJ		
D	8026	G2060004 DIODE	1SS270TJ		
D	8027	G2060004 DIODE	1SS270TJ		
D	8028	G2060004 DIODE	1SS270TJ		
D	8029	G2060004 DIODE	1SS270TJ		
D	8030	G2060004 DIODE	1SS270TJ		
D	8031	G2060004 DIODE	1SS270TJ		
D	8032	G2060004 DIODE	1SS270TJ		
D	8033	G2060004 DIODE	1SS270TJ		
D	8034	G2060004 DIODE	1SS270TJ		
D	8035	G2060004 DIODE	1SS270TJ		
D	8036	G2060004 DIODE	1SS270TJ		
D	8037	G2060004 DIODE	1SS270TJ		
D	8038	G2060004 DIODE	1SS270TJ		
D	8039	G2060004 DIODE	1SS270TJ		
D	8040	G2090467 DIODE	RD47EB		
J	8001	P0090622 CONNECTOR	SC25-03WS		
J	8002	P0090623 CONNECTOR	SC25-04WS		
J	8003	P0090627 CONNECTOR	SC25-08WS		
J	8004	P0090628 CONNECTOR	SC25-09WS		
J	8005	P0090630 CONNECTOR	SC25-11WS		
J	8006	P0090630 CONNECTOR	SC25-11WS		
J	8007	P0090621 CONNECTOR	SC25-02WS		
J	8008	P0090621 CONNECTOR	SC25-02WS		
J	8009	P0090621 CONNECTOR	SC25-02WS		
J	8010	P0090625 CONNECTOR	SC25-06WS		
J	8011	P0090631 CONNECTOR	SC25-12WS		
J	8012	P0090626 CONNECTOR	SC25-07WS		
J	8013	P0090625 CONNECTOR	SC25-06WS		
L	8001	L1190385 M. RFC	RCR-875D-471K	470uH	
L	8002	L1190385 M. RFC	RCR-875D-471K	470uH	
Q	8001	G1091008 IC	HD63B05XOP-***		
Q	8002	G1090836 IC	M54564P		
Q	8003	G1090836 IC	M54564P		
Q	8004	G1090836 IC	M54564P		
Q	8005	G1090836 IC	M54564P		
Q	8006	G1090979 IC	UPD74HC238C		
Q	8007	G1090979 IC	UPD74HC238C		
Q	8008	G1090979 IC	UPD74HC238C		

For Service Manuals Contact
MAURITRON TECHNICAL SERVICES
 8 Cherry Tree Rd. Chinnor
 Oxon OX9 4QY
 Tel: 01844-351894 Fax: 01844-352554
 Email: enquiries@mauritron.co.uk

Display Unit Parts List

ADD	CODE NO	DESCRIPTION	DEVICE	TYP	VAL
Q	8009	G1090088	IC	MC14028BCP	
Q	8010	G1090088	IC	MC14028BCP	
Q	8011	G3050003	TRANSISTOR	BA1A4P-T	
Q	8012	G3406670C	TRANSISTOR	2SD667C	
Q	8013	G3050003	TRANSISTOR	BA1A4P-T	
Q	8014	G3090075	TRANSISTOR	BN1A4P	
Q	8015	G3050002	TRANSISTOR	BN1A4P-T	
Q	8016	G3090075	TRANSISTOR	BN1A4P	
Q	8017	G3050002	TRANSISTOR	BN1A4P-T	
Q	8018	G3090075	TRANSISTOR	BN1A4P	
Q	8019	G3050002	TRANSISTOR	BN1A4P-T	
Q	8020	G3090075	TRANSISTOR	BN1A4P	
Q	8021	G3050002	TRANSISTOR	BN1A4P-T	
Q	8022	G3050002	TRANSISTOR	BN1A4P-T	
Q	8023	G3090075	TRANSISTOR	BN1A4P	
Q	8024	G3050002	TRANSISTOR	BN1A4P-T	
Q	8025	G3050003	TRANSISTOR	BA1A4P-T	
Q	8026	G3331570	TRANSISTOR	2SC3157	
Q	8027	G3304584B	TRANSISTOR	2SC458BTZ	
Q	8028	G1090936	IC	HA17805P	
Q	8029	G3050003	TRANSISTOR	BA1A4P-T	
Q	8030	G3050003	TRANSISTOR	BA1A4P-T	
Q	8031	G1090840	IC	M51943BSL	
R	8001	J07225682	CARBON FILM RES.	RD16TPJ682	6.8K 6.8K 1/6W
R	8002	J07225682	CARBON FILM RES.	RD16TPJ682	6.8K 6.8K 1/6W
R	8003	J07225682	CARBON FILM RES.	RD16TPJ682	6.8K 6.8K 1/6W
R	8004	J07225471	CARBON FILM RES.	RD16TPJ471	470 470 1/6W
R	8005	J07225471	CARBON FILM RES.	RD16TPJ471	470 470 1/6W
R	8006	J07225221	CARBON FILM RES.	RD16TPJ221	220 220 1/6W
R	8007	J07225103	CARBON FILM RES.	RD16TPJ103	10K 10K 1/6W
R	8008	J07225681	CARBON FILM RES.	RD16TPJ681	680 680 1/6W
R	8009	J07225681	CARBON FILM RES.	RD16TPJ681	680 680 1/6W
R	8010	J07225103	CARBON FILM RES.	RD16TPJ103	10K 10K 1/6W
R	8011	J07225102	CARBON FILM RES.	RD16TPJ102	1K 1K 1/6W
R	8013	J07225103	CARBON FILM RES.	RD16TPJ103	10K 10K 1/6W
R	8014	J07225102	CARBON FILM RES.	RD16TPJ102	1K 1K 1/6W
R	8015	J20336390	METAL FILM RES.	RS2B 2W K 39	39 2W
R	8016	J07225681	CARBON FILM RES.	RD16TPJ681	680 680 1/6W
R	8017	J02225101	CARBON FILM RES.	RD16UJ101	100 100 1/6W
R	8018	J02225102	CARBON FILM RES.	RD16UJ102	1K 1K 1/6W
R	8019	J02225682	CARBON FILM RES.	RD16UJ682	6.8K 6.8K 1/6W
R	8020	J07225104	CARBON FILM RES.	RD16TPJ104	100K 100K 1/6W
R	8021	J07225472	CARBON FILM RES.	RD16TPJ472	4.7K 4.7K 1/6W
R	8022	J20336220	METAL FILM RES.	RS2B 2W K 22	22 2W
R	8023	J07225103	CARBON FILM RES.	RD16TPJ103	10K 10K 1/6W
T	8001	L3030134	DC-DC TRANS. 2710	2710	
V	8001	G6090077	FCD FIP22AM9	FIP22AM9	
X	8001	H7900580	CERAMIC OSC	CSA8.00MT	

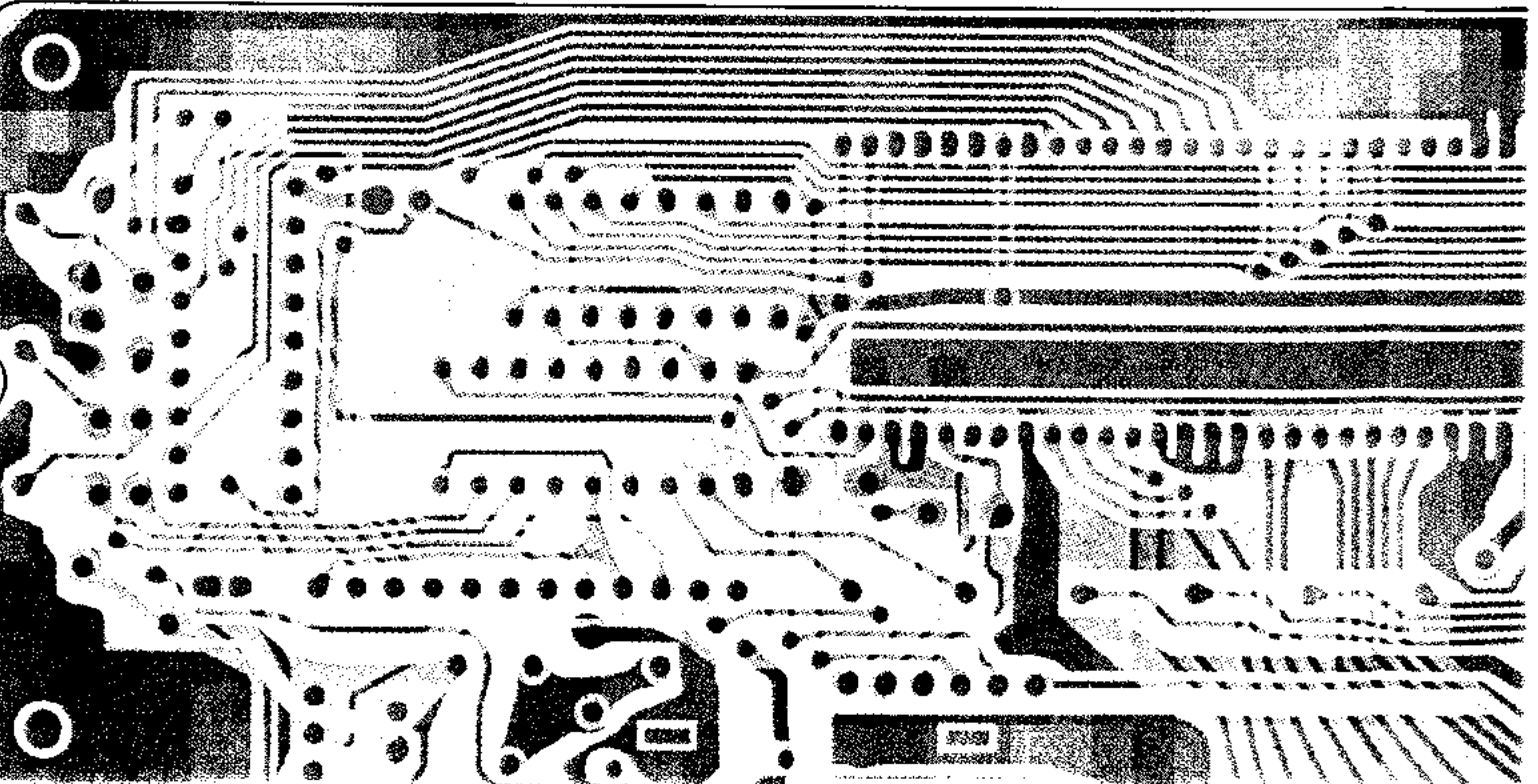
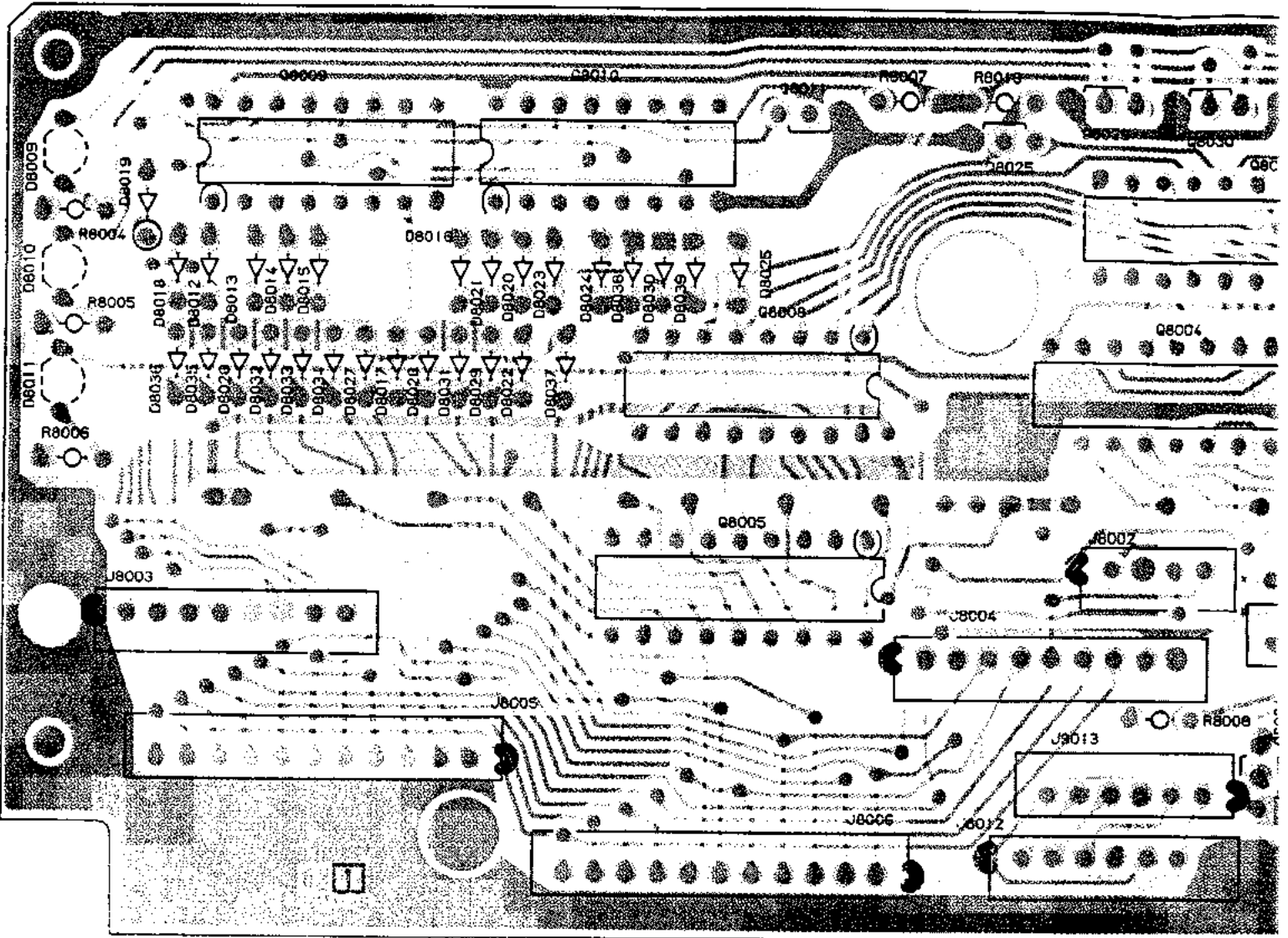

For Service Manuals Contact
MAURITRON TECHNICAL SERVICES
8 Cherry Tree Rd, Chinnor
Oxon OX9 4GJ
Tel: 01844 351694 Fax: 01844 352304
Email: enquiries@mauritron.co.uk

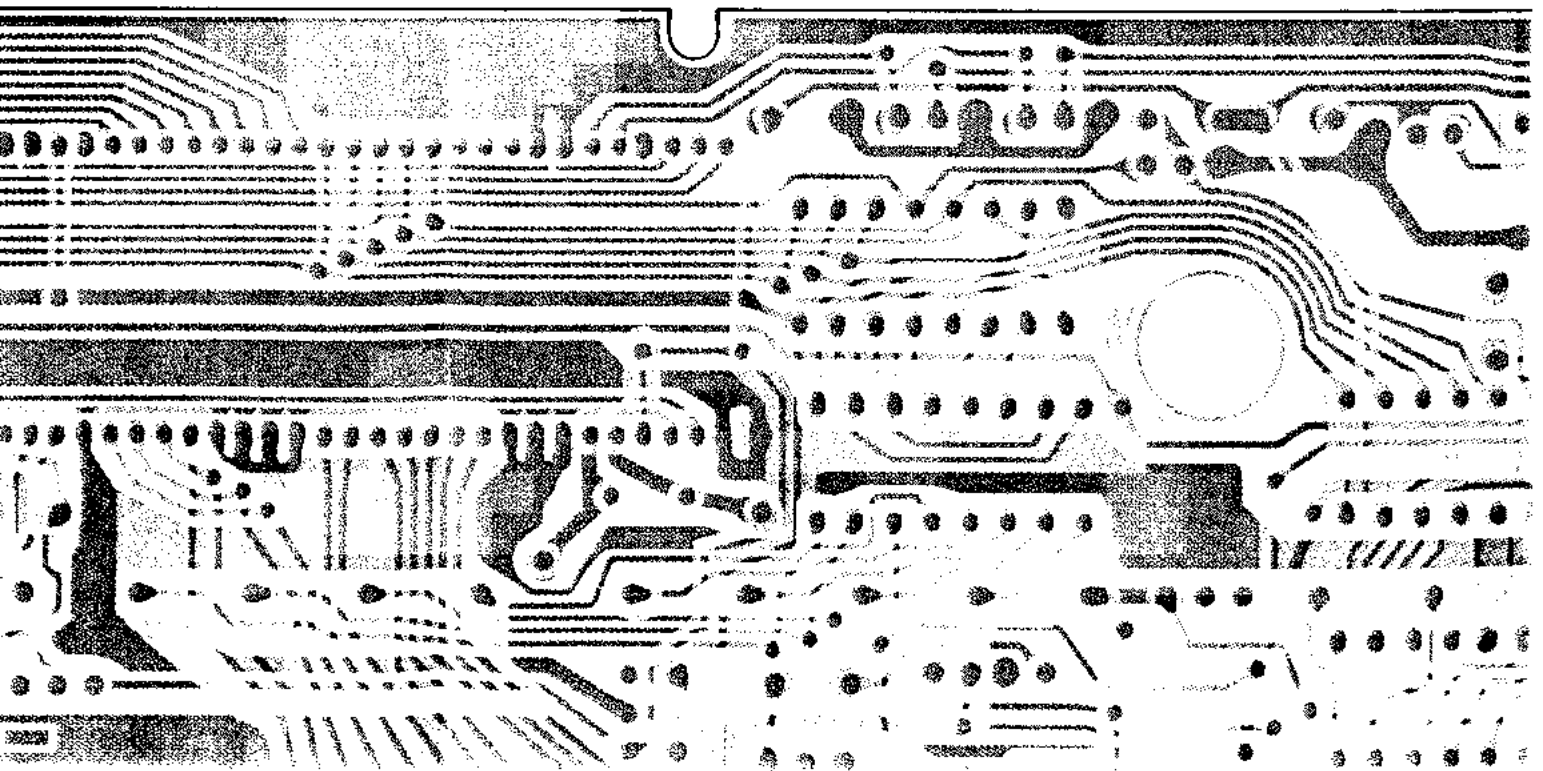
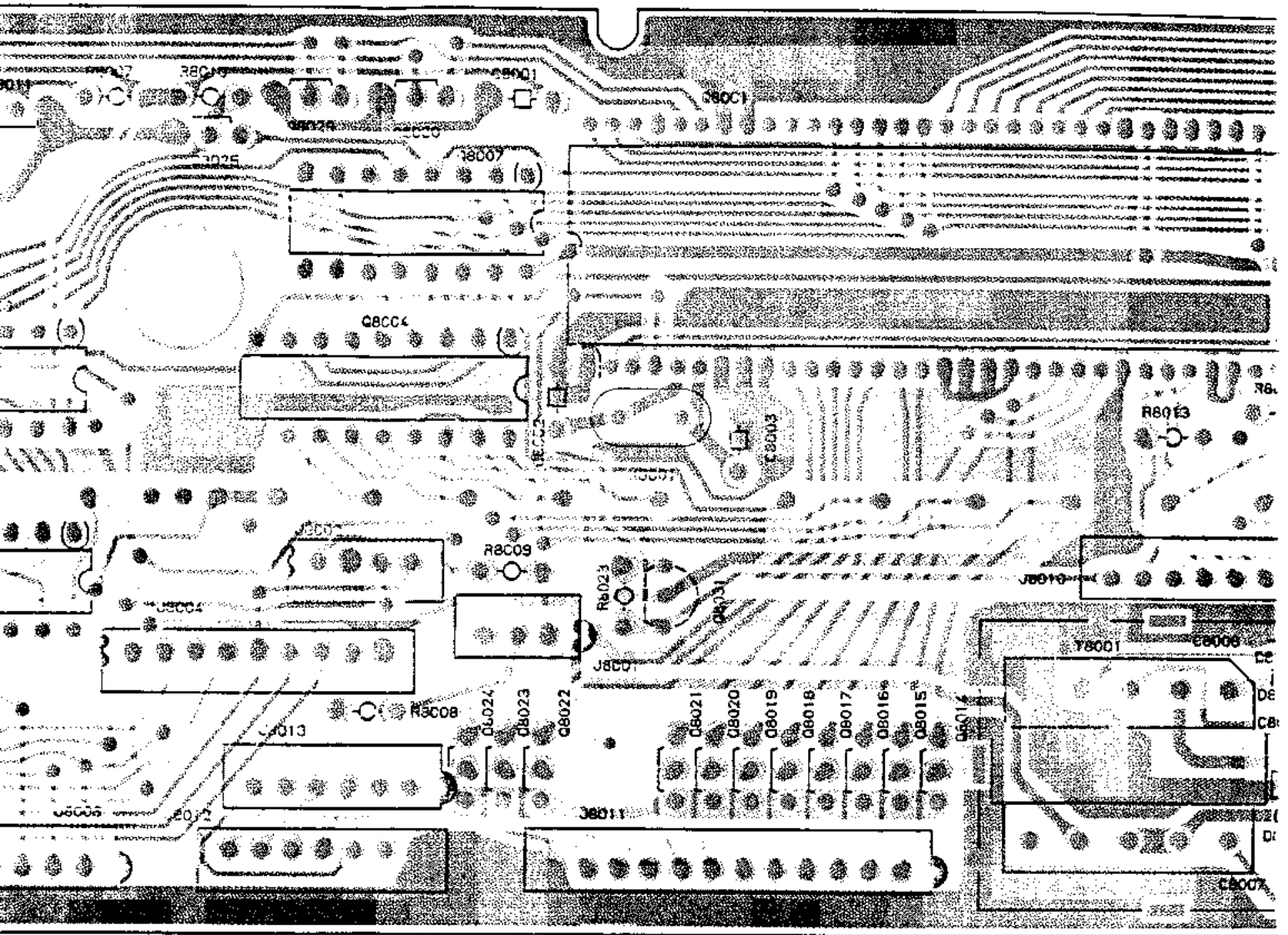

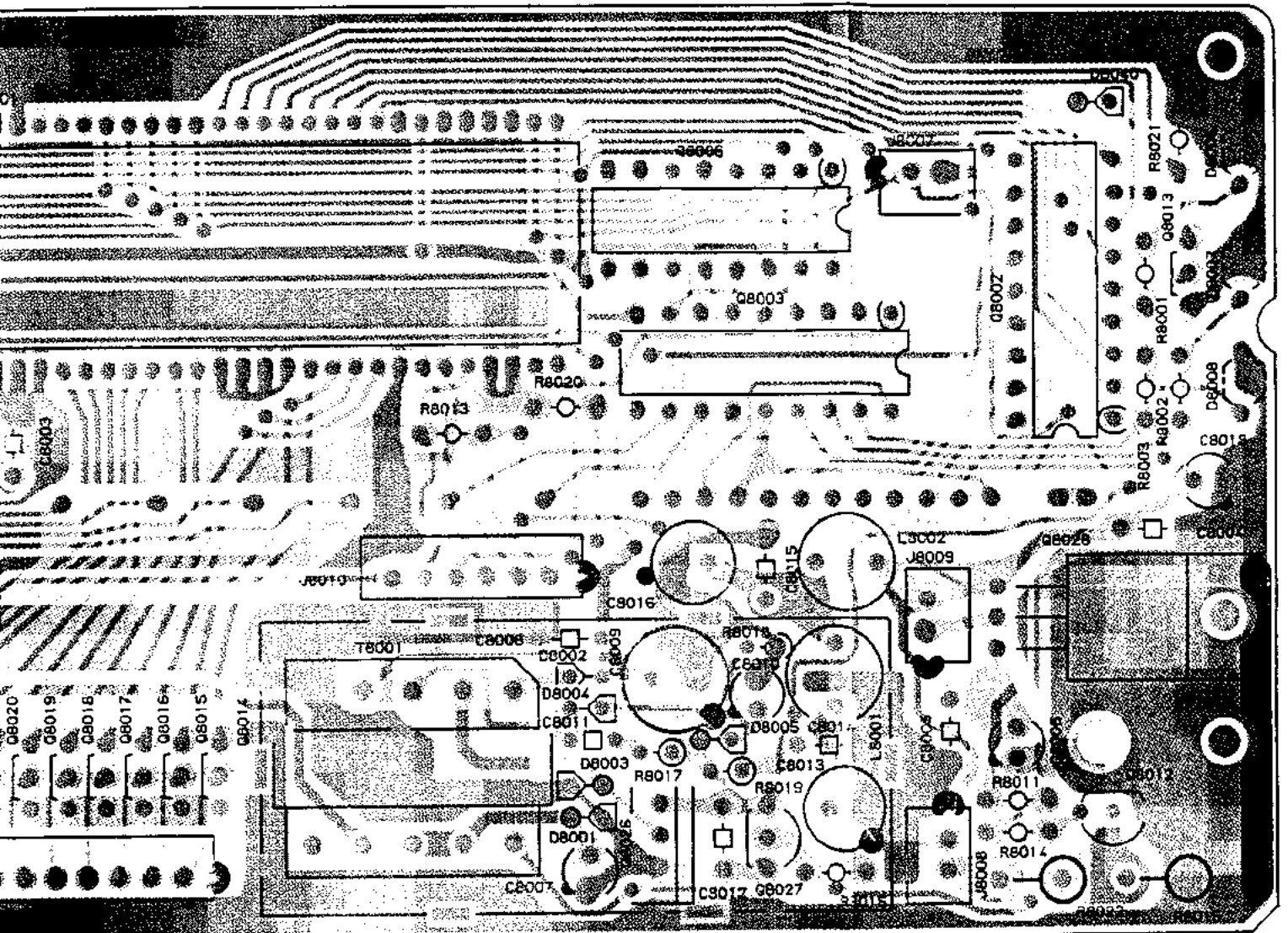

(obverse view of "component" side)

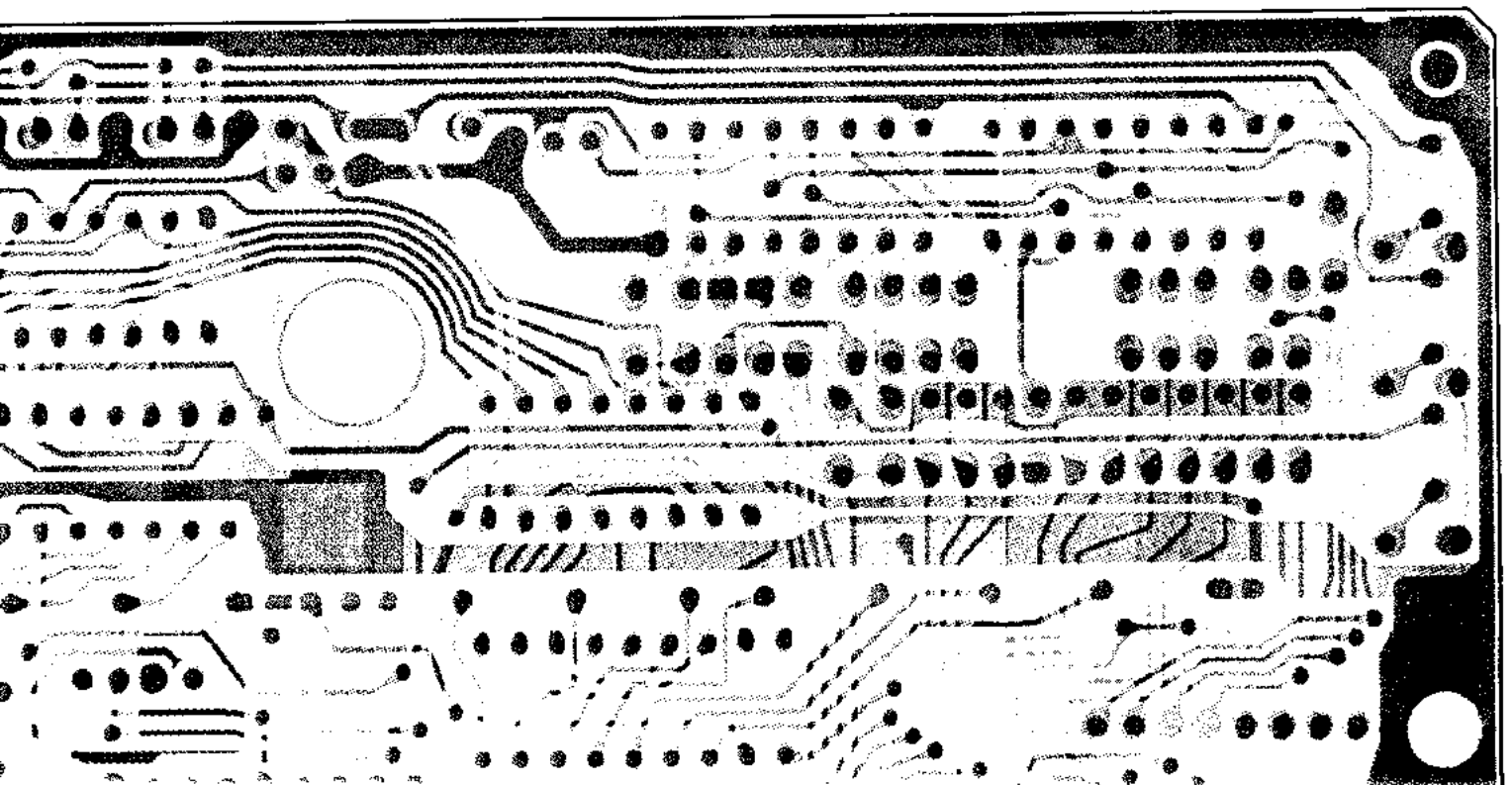

Display Unit Board Layout

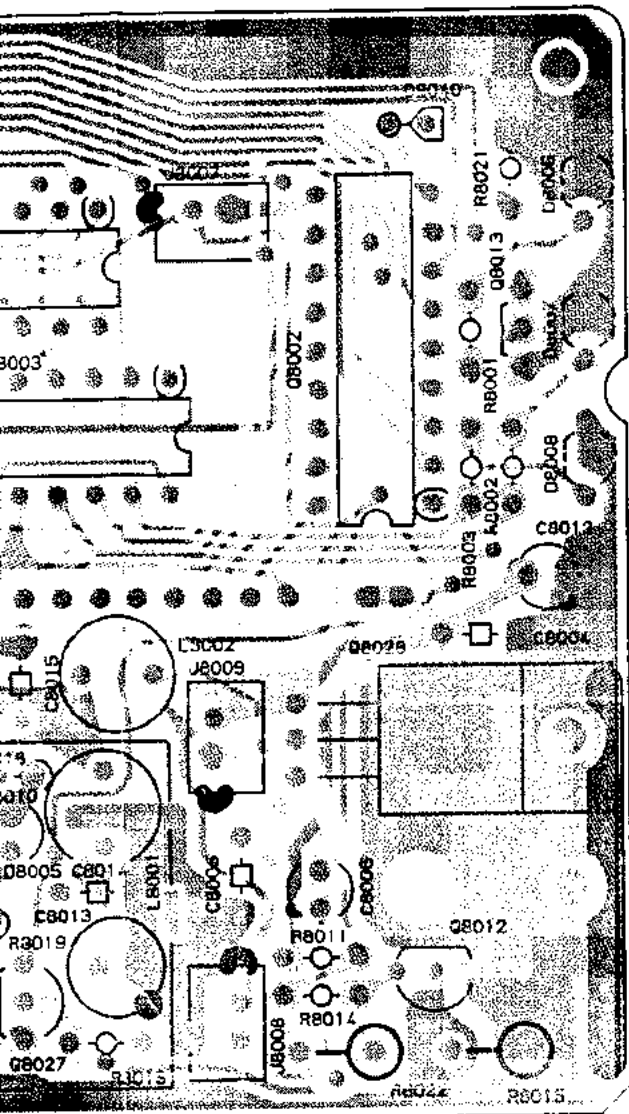

(obverse view of "component" side)

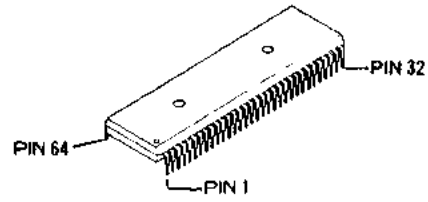

HD63B05X0B08P
(Q8001)

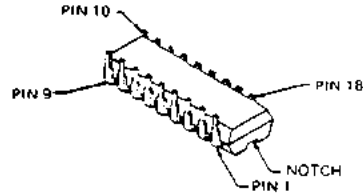

M54564P
(Q8002, Q8003,
Q8004, Q8005)

For Service Manuals Contact
MAURITRON TECHNICAL SERVICES
8 Cherry Tree Rd, Chinnor
Oxon OX9 4QY
Tel: 01844-351694 Fax: 01844-352554
Email: enquiries@maurtron.co.uk

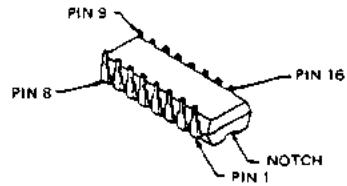
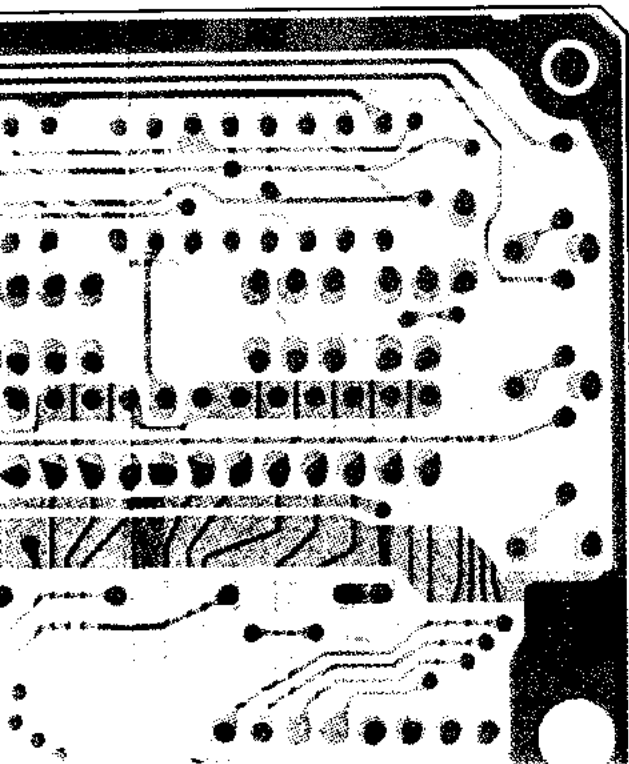

MC14028BCP
(Q8009, Q8010)
μPD74HC238C
(Q8006, Q8007, Q8008)

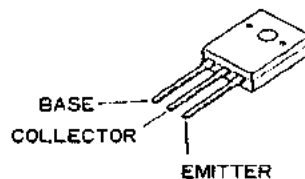

2SC3157
(Q8026)

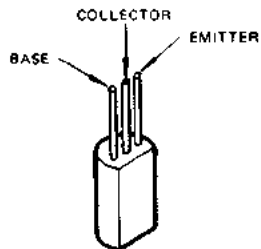
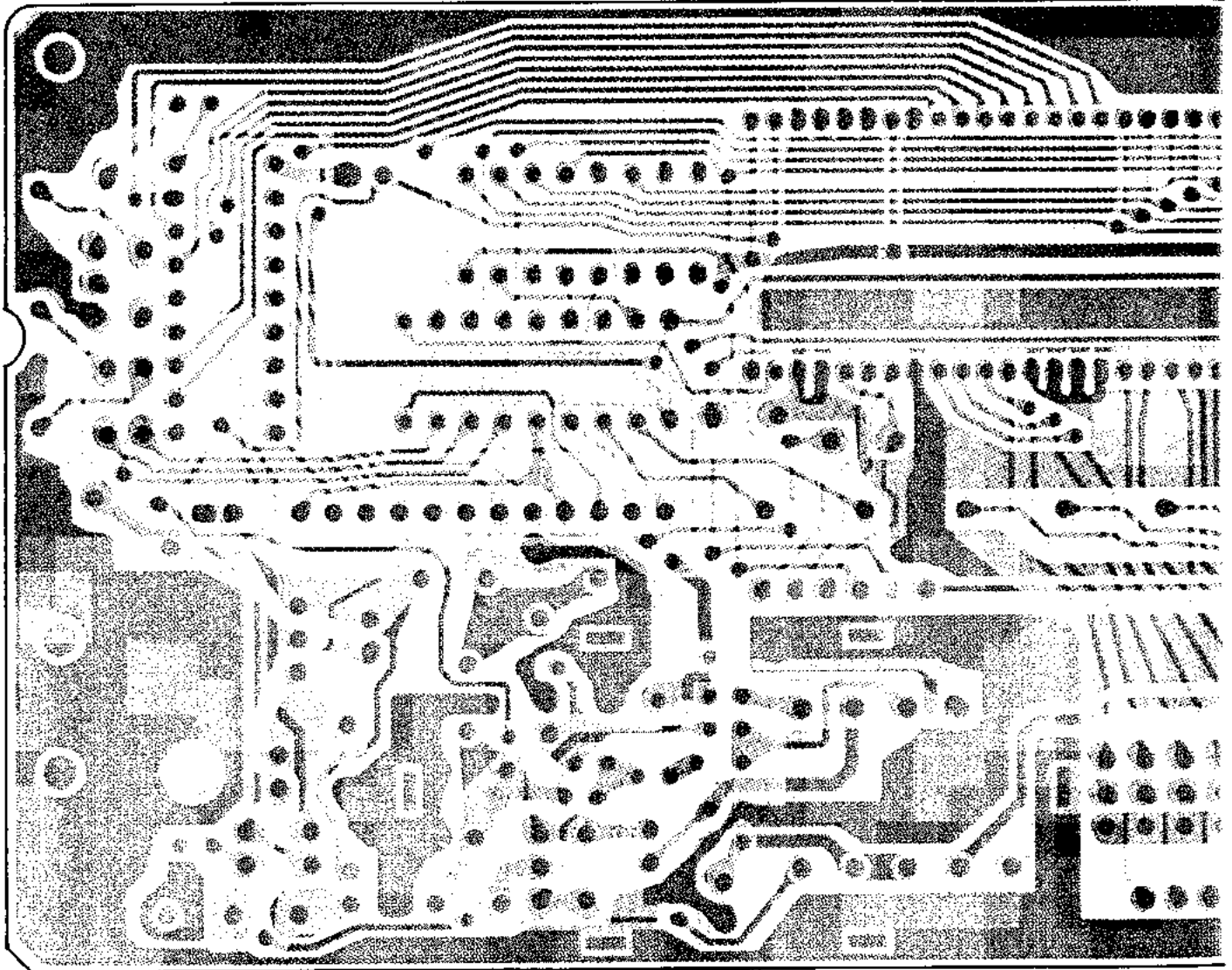
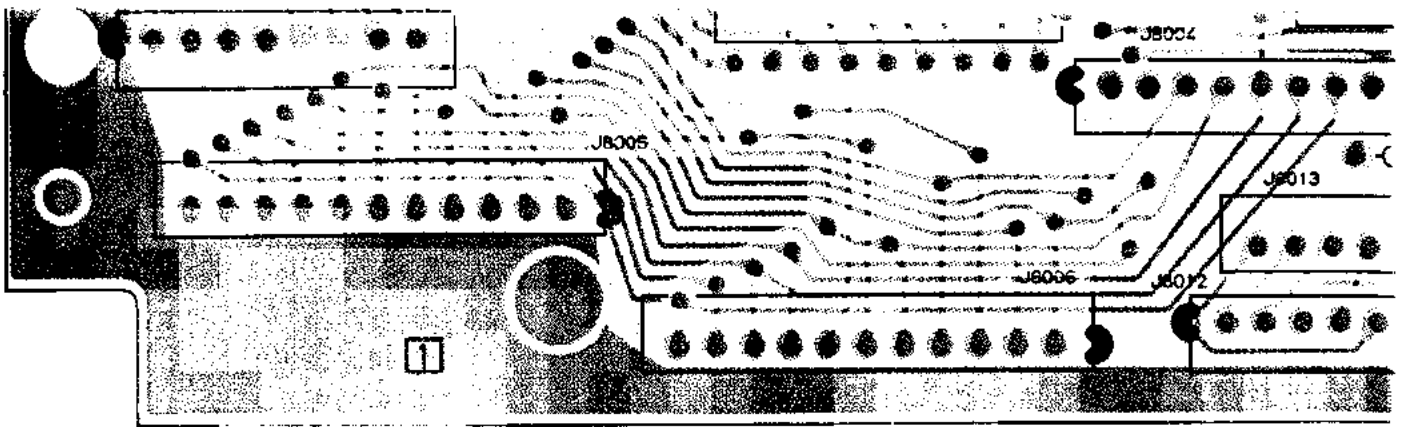

2SD6670
(08012)

COLLECTOR
BASE —

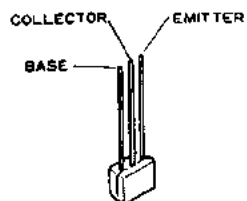
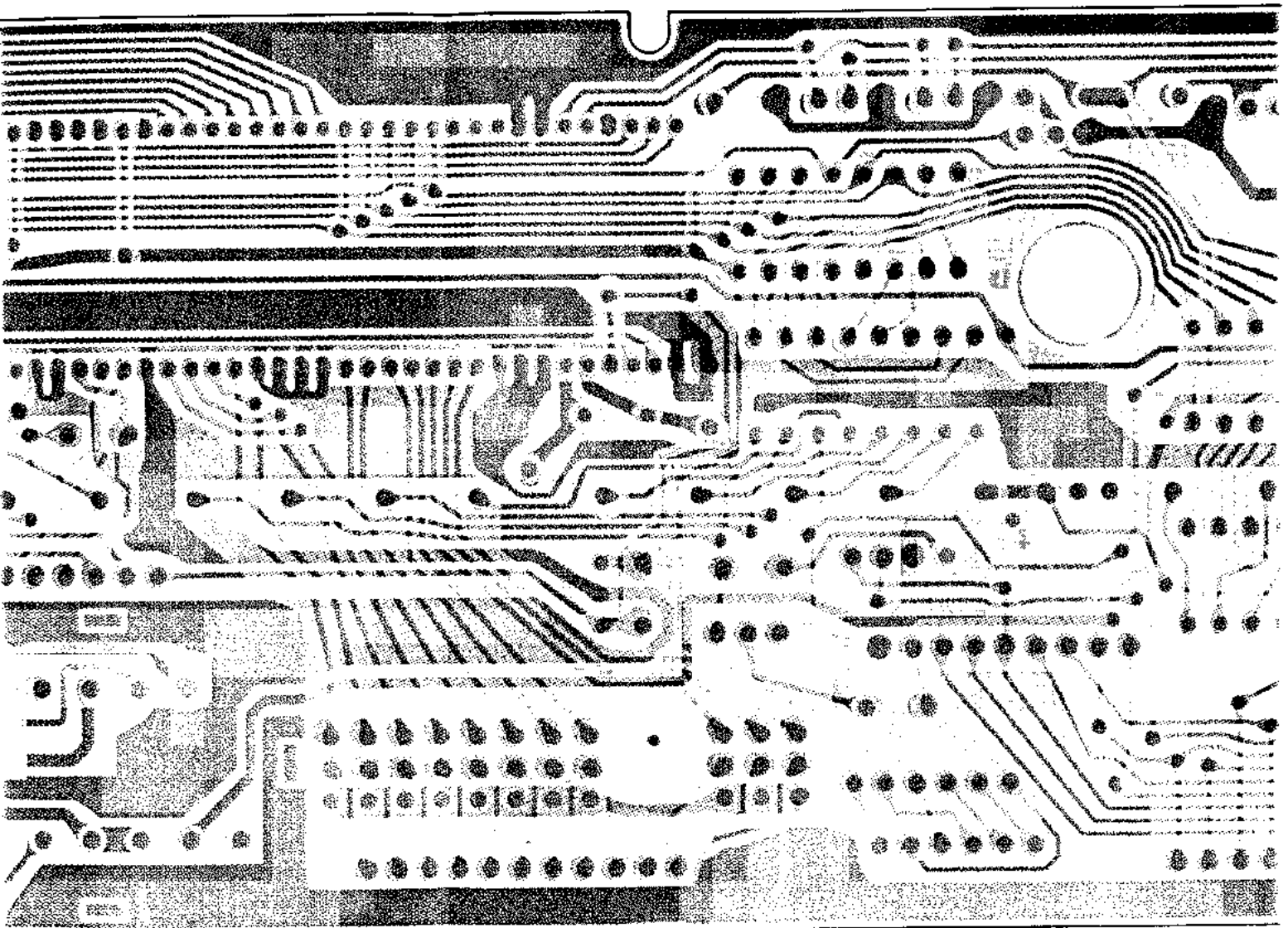
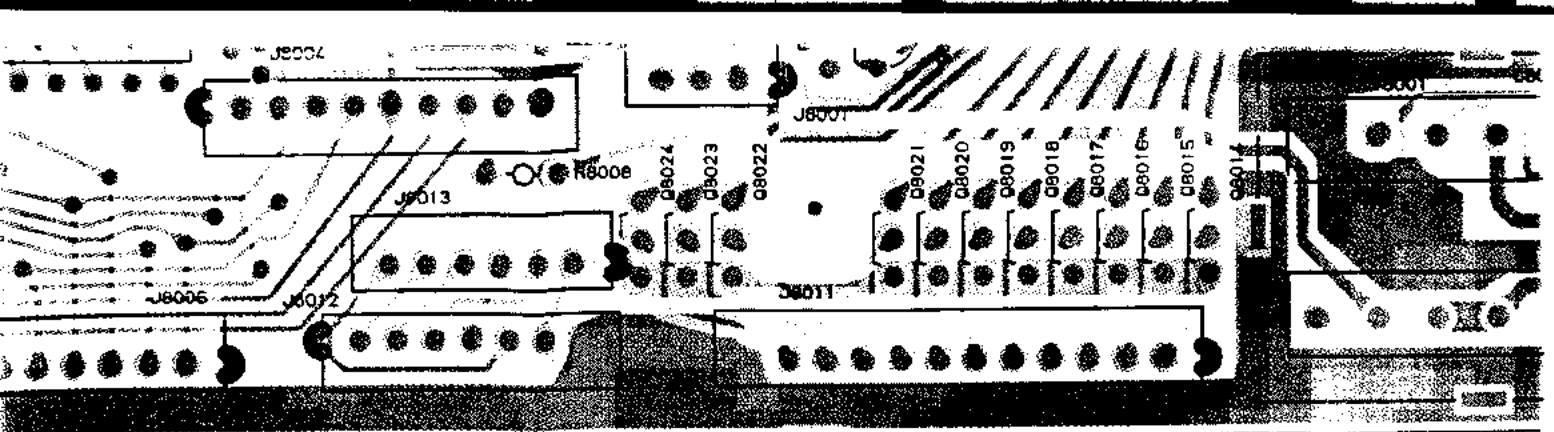

BN1A4P
 (Q8014, Q8015, Q8016, Q8017, Q8018, Q8019,
 Q8020, Q8021, Q8022, Q8023, Q8024)

BA1A4P
 (Q8013, Q8025, Q8029,
 Q8030, Q8011)

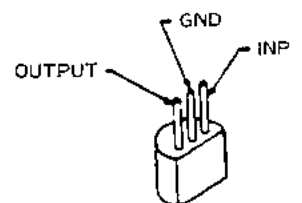

M51943BSL
 (Q8031)

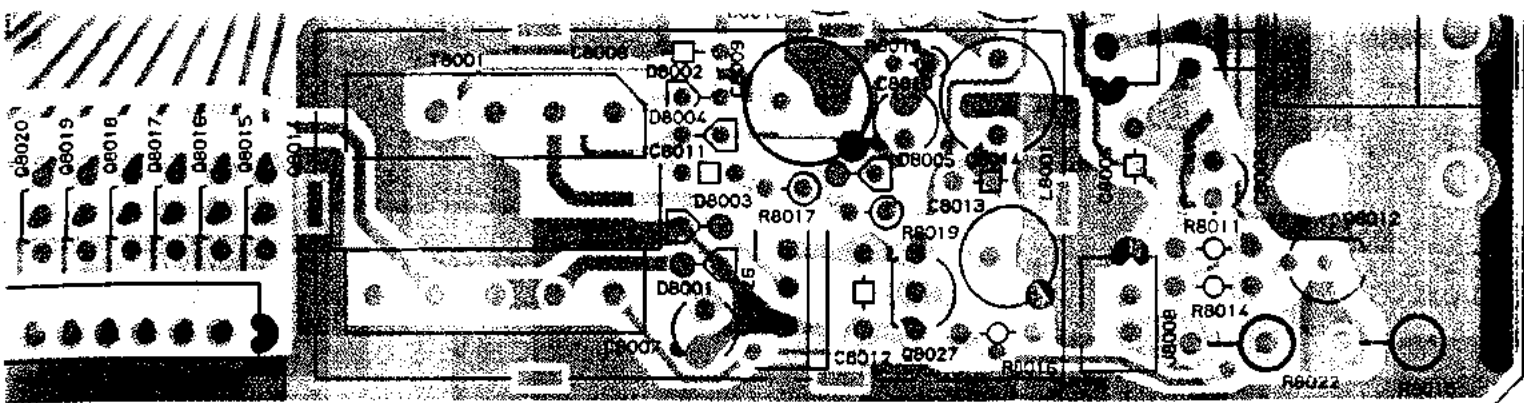

(obverse view of "component" side)

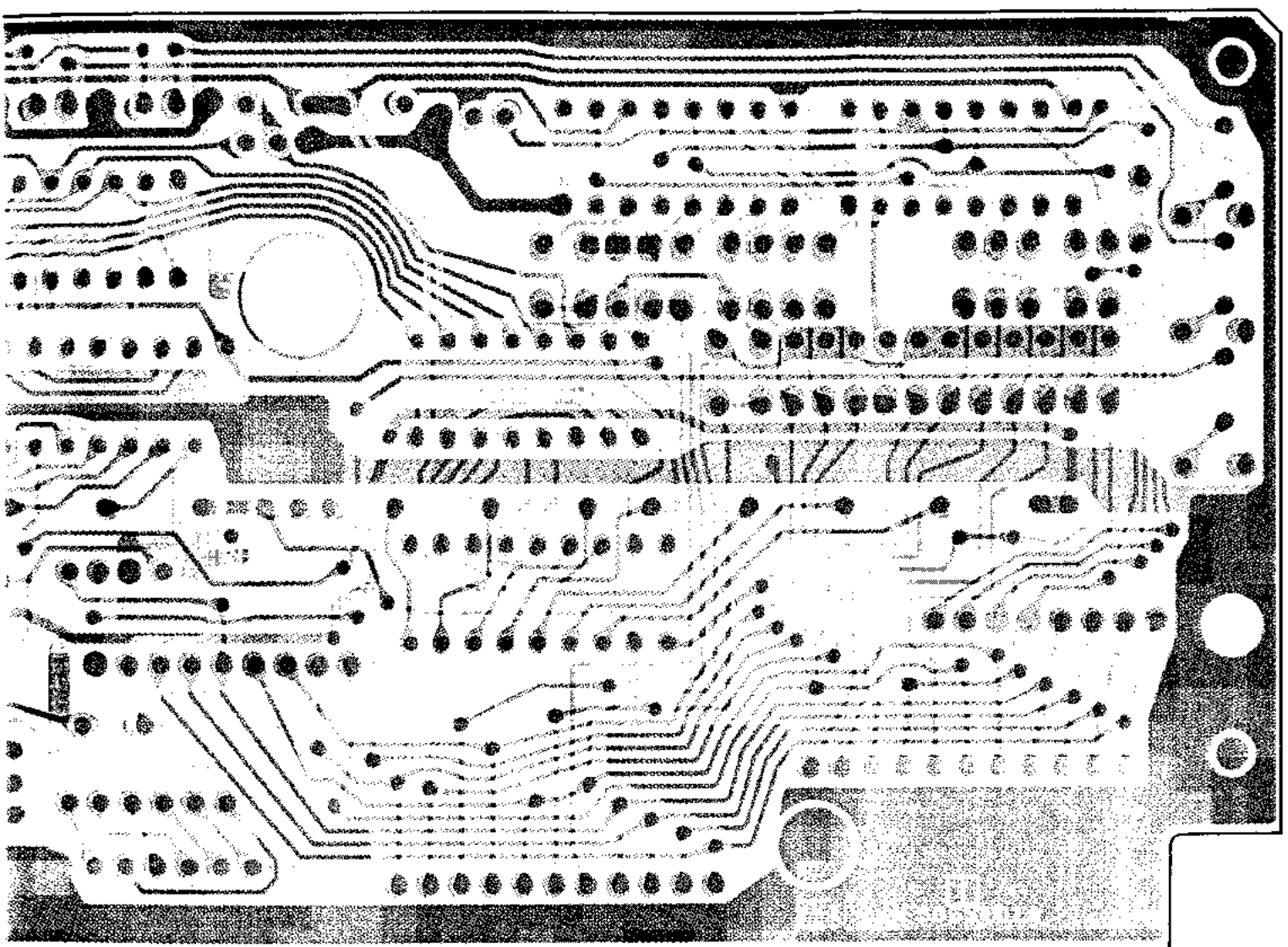

(obverse view of "solder" side)

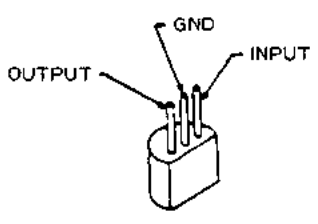

M51943BSL
(Q8031)

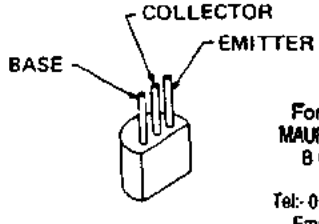

2SC458BTZ
(Q8027)

For Service Manuals Contact
MAURITRON TECHNICAL SERVICES
 8 Cherry Tree Rd. Chinnor
 Oxfordshire OX9 3EY
 Tel: 01844 894100 Fax: 01844 894104
 Email: info@mauritron.co.uk

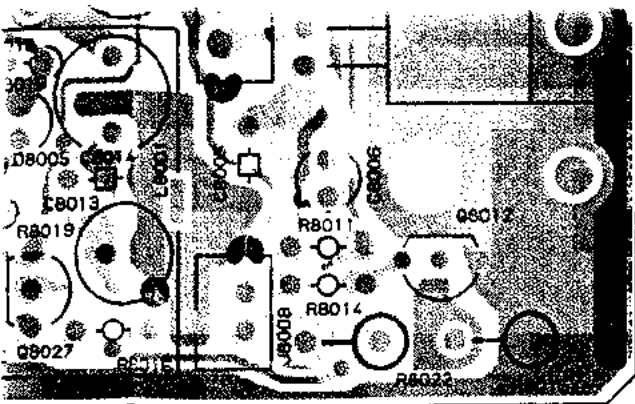

(obverse view of "component" side)

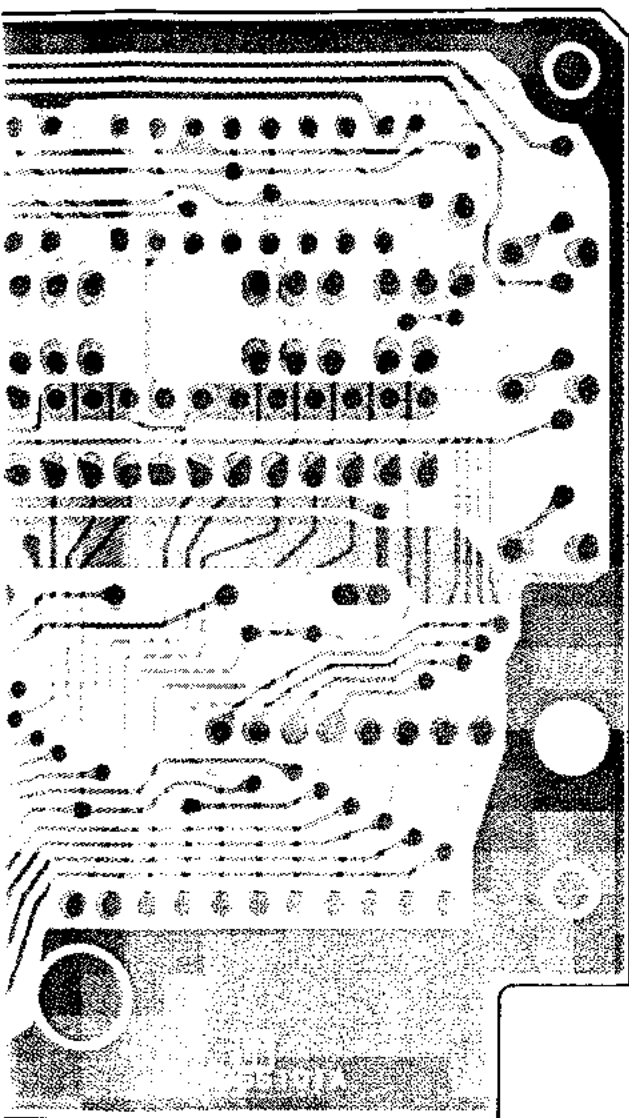

(obverse view of "solder" side)

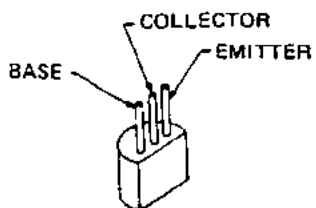

2SC458BTZ
(Q8027)



M54564P
(Q8002, Q8003,
Q8004, Q8005)

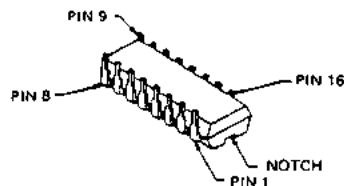

MC14028BCP
(Q8009, Q8010)
μPD74HC238C
(Q8006, Q8007, Q8008)

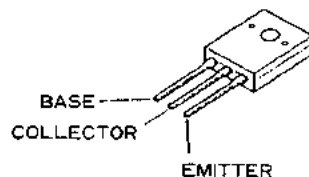

2SC03157
(Q8026)

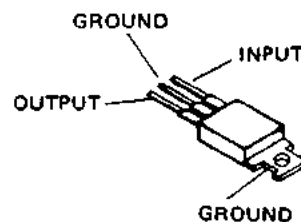

HA17805P
(Q8028)

DISPLAY UNIT
F3065101A

For Service Manuals Contact
MAURITRON TECHNICAL SERVICES
 8 Cherry Tree Rd, Chinnor
 Oxon OX9 4QY
 Tel: 01844 351694 Fax: 01844 352554
 Email: enquiries@mauritron.co.uk

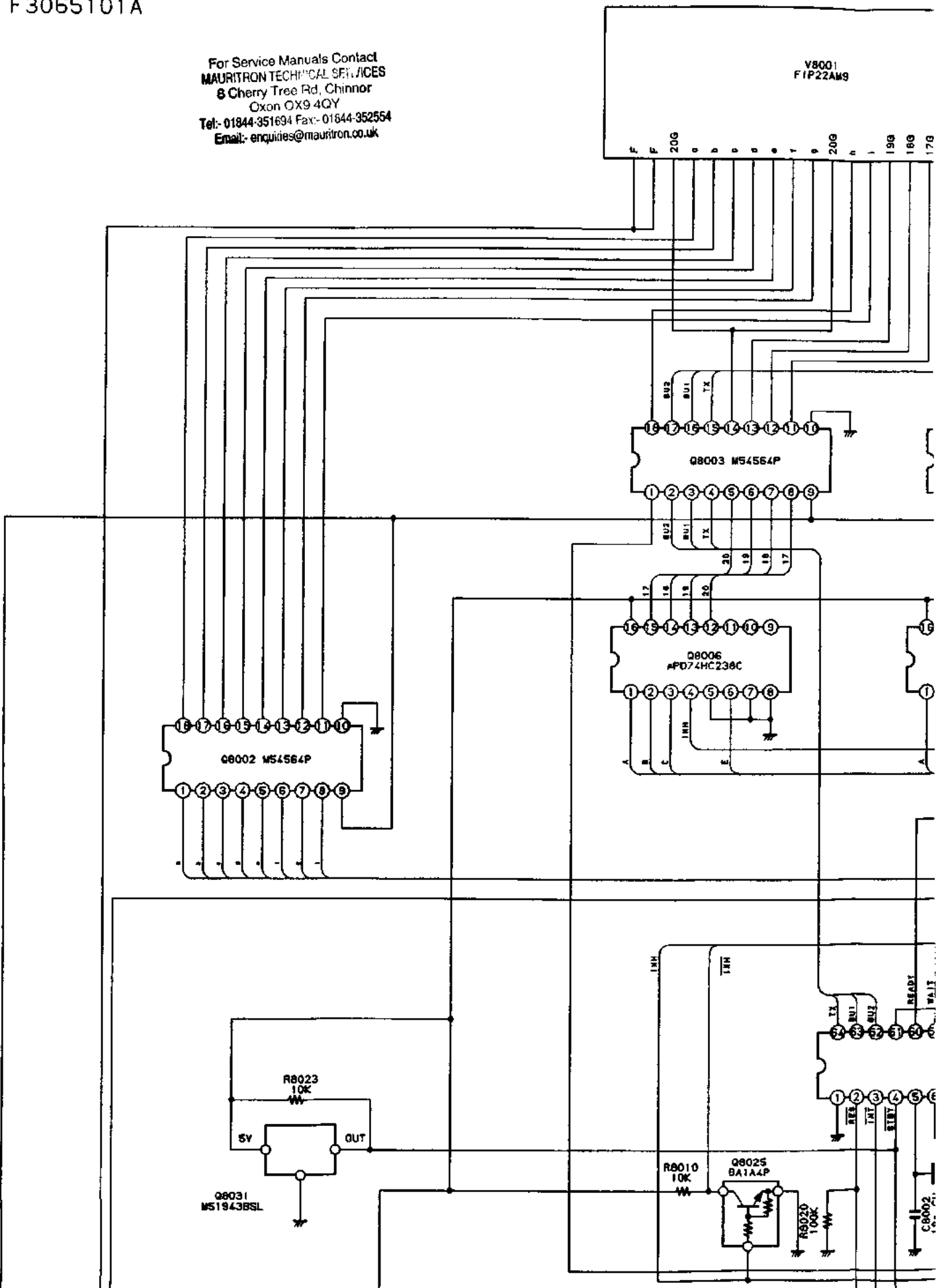

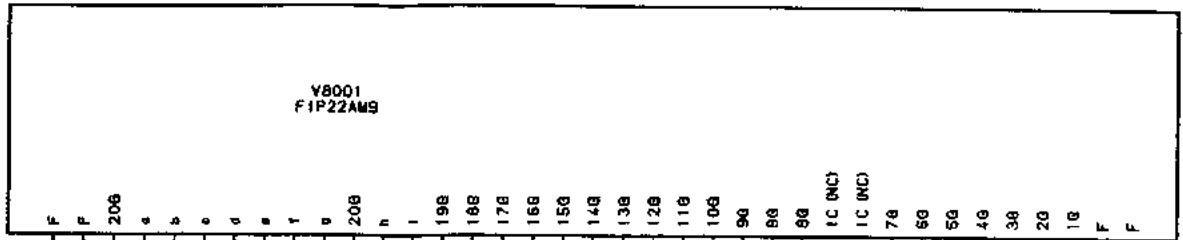

For Service Manuals Contact
 MAURITRON TELECOMMUNICATIONS LTD
 8 Cherry Tree Rd, Chinnor
 Oxon OX3 4QY
 Tel: 01844-351994 Fax: 01844-352554
 Email: enquiries@maurtron.co.uk

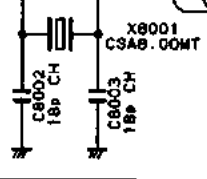
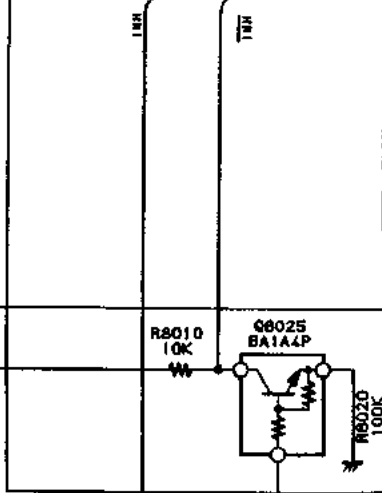
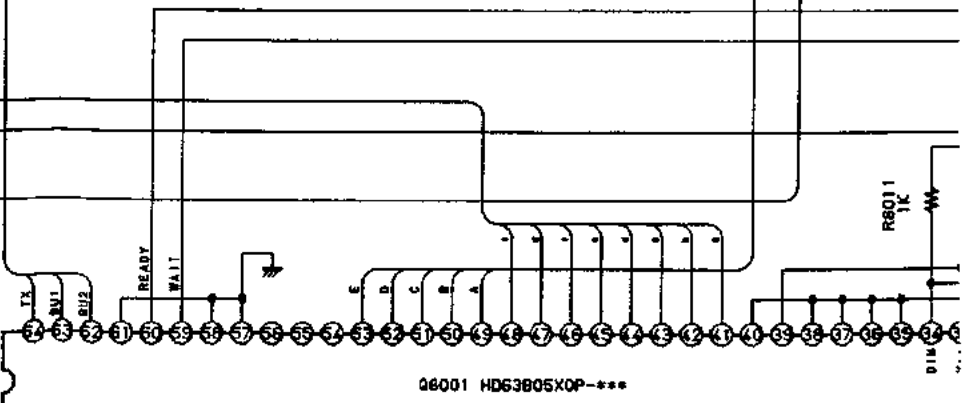
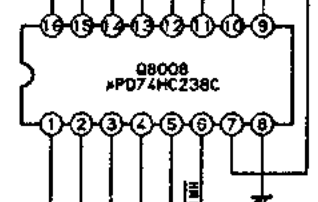
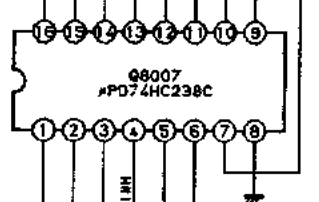
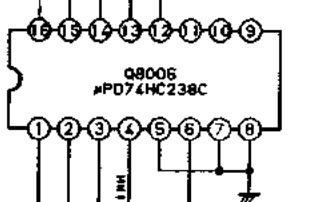
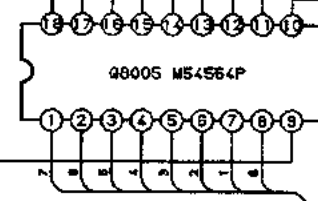
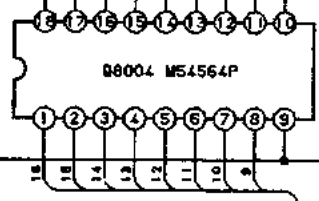
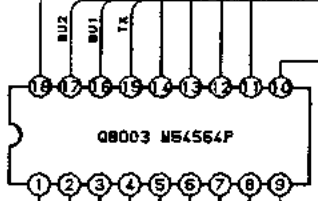

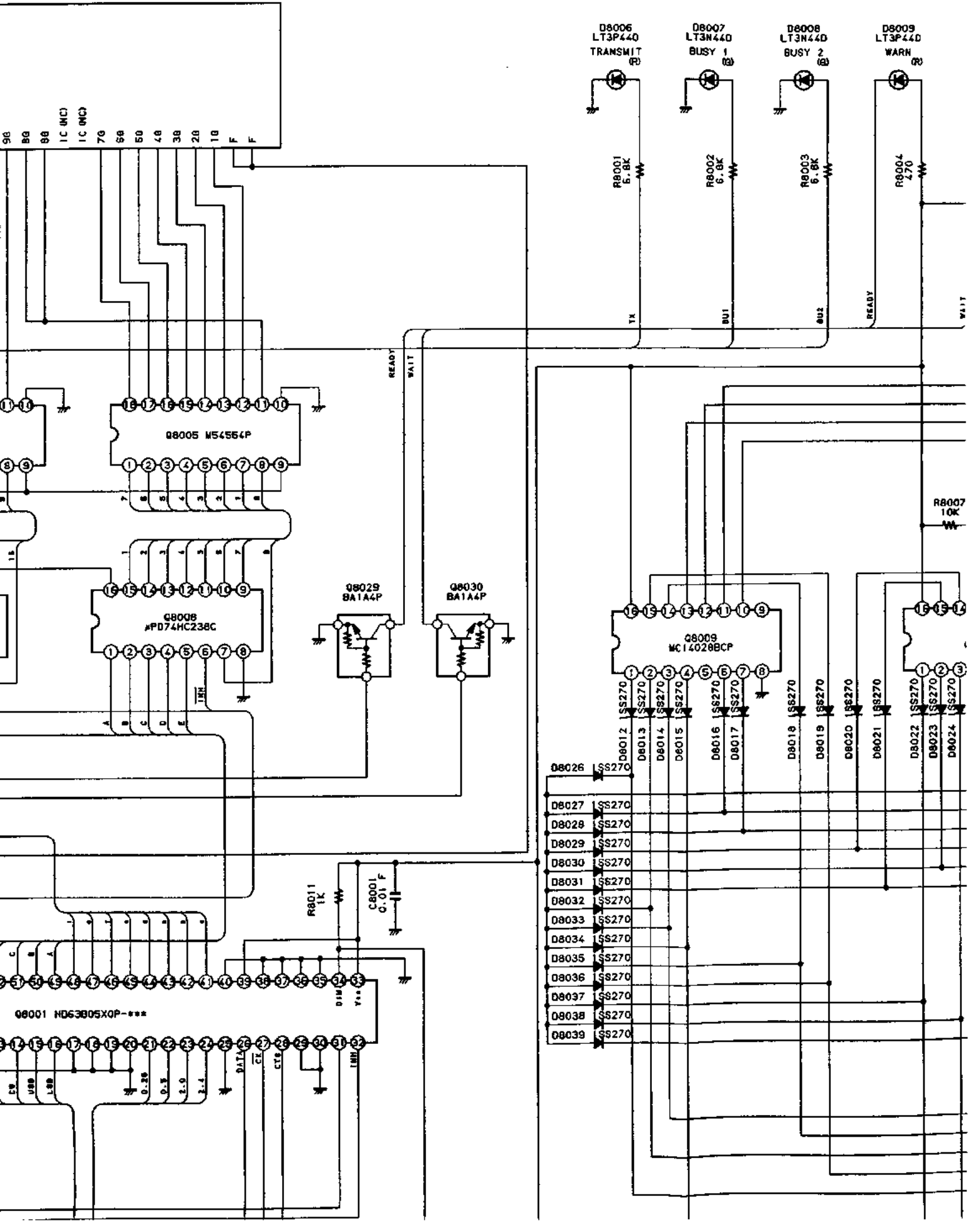

Display Unit Schematic Diagram

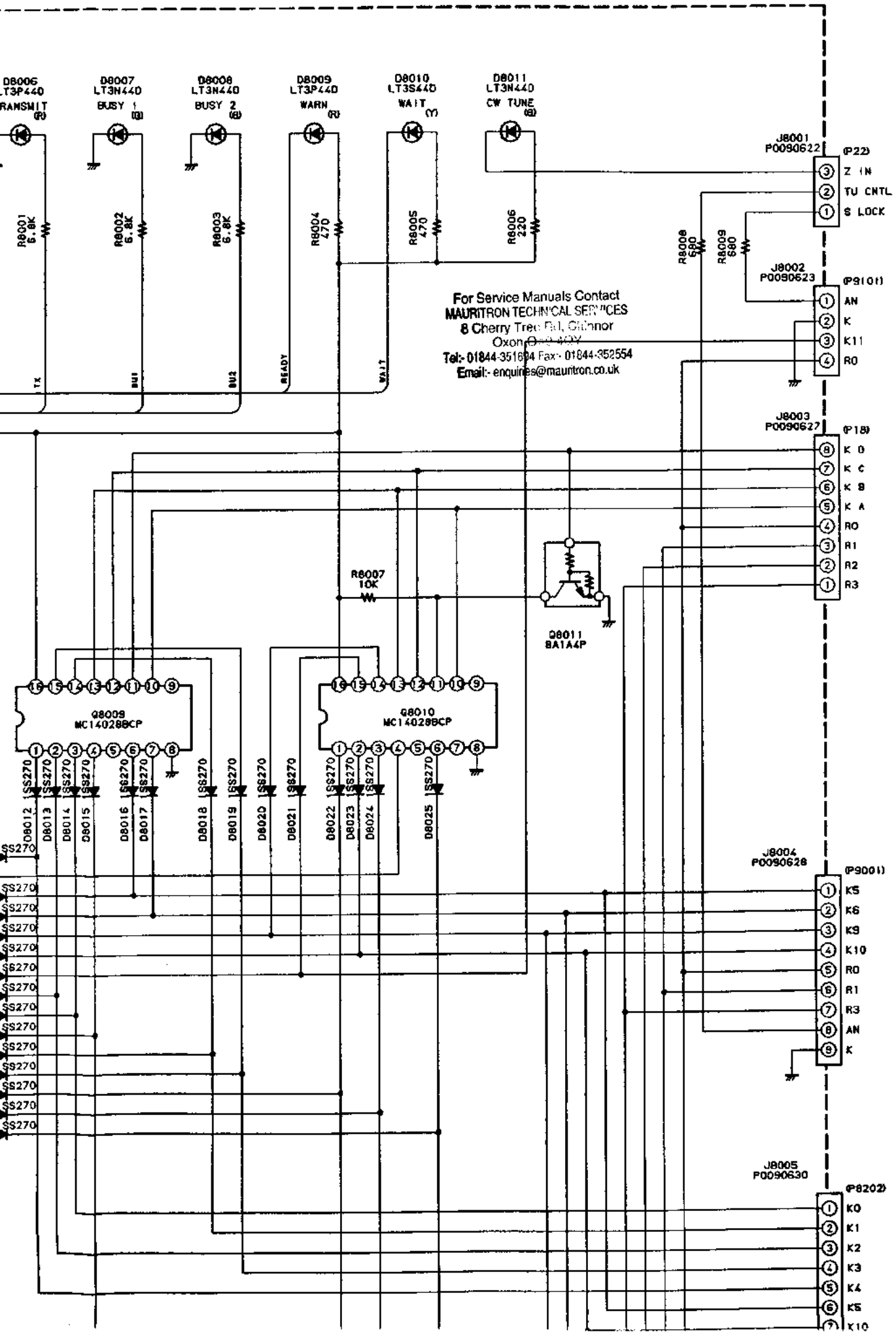

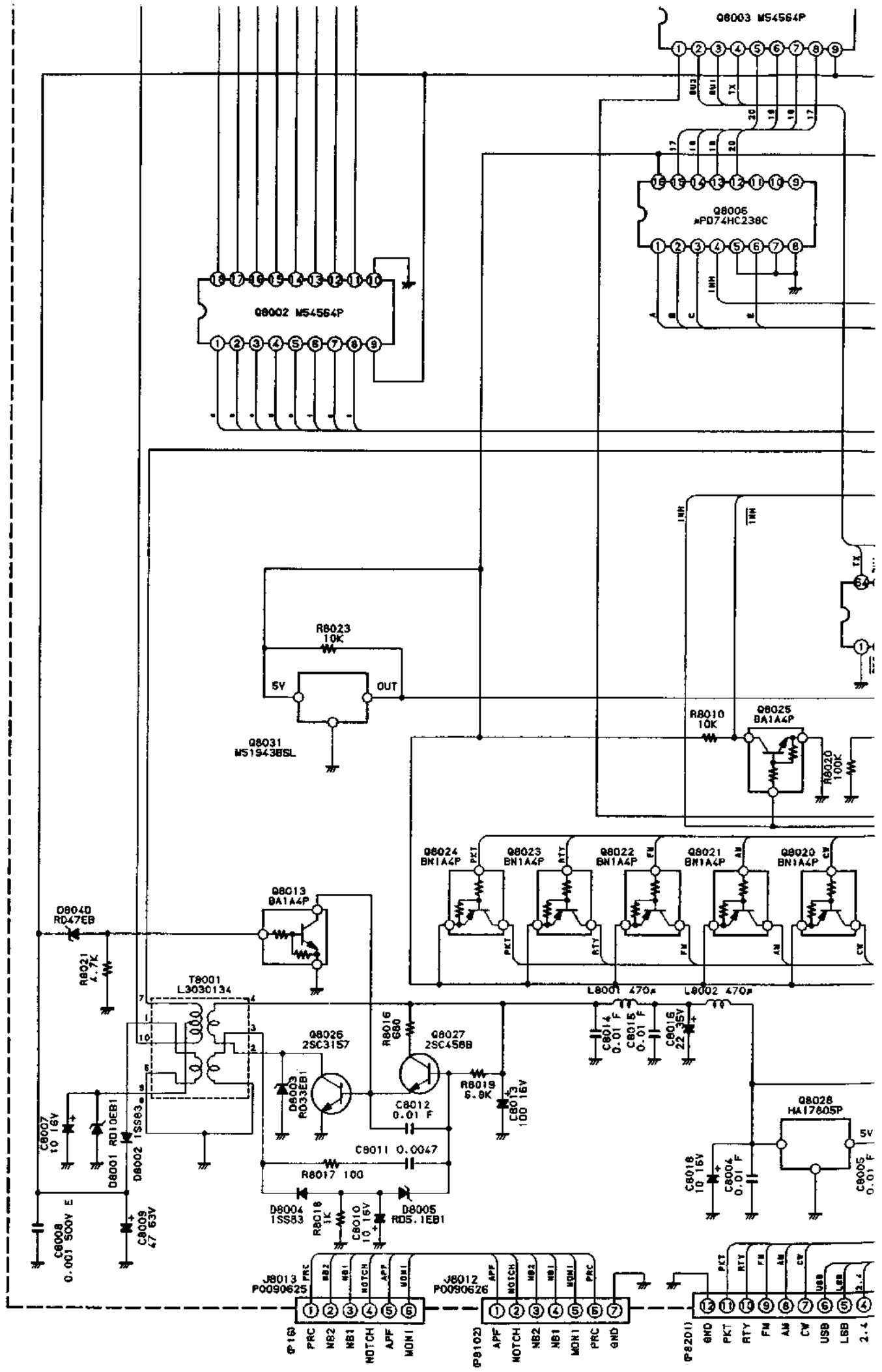

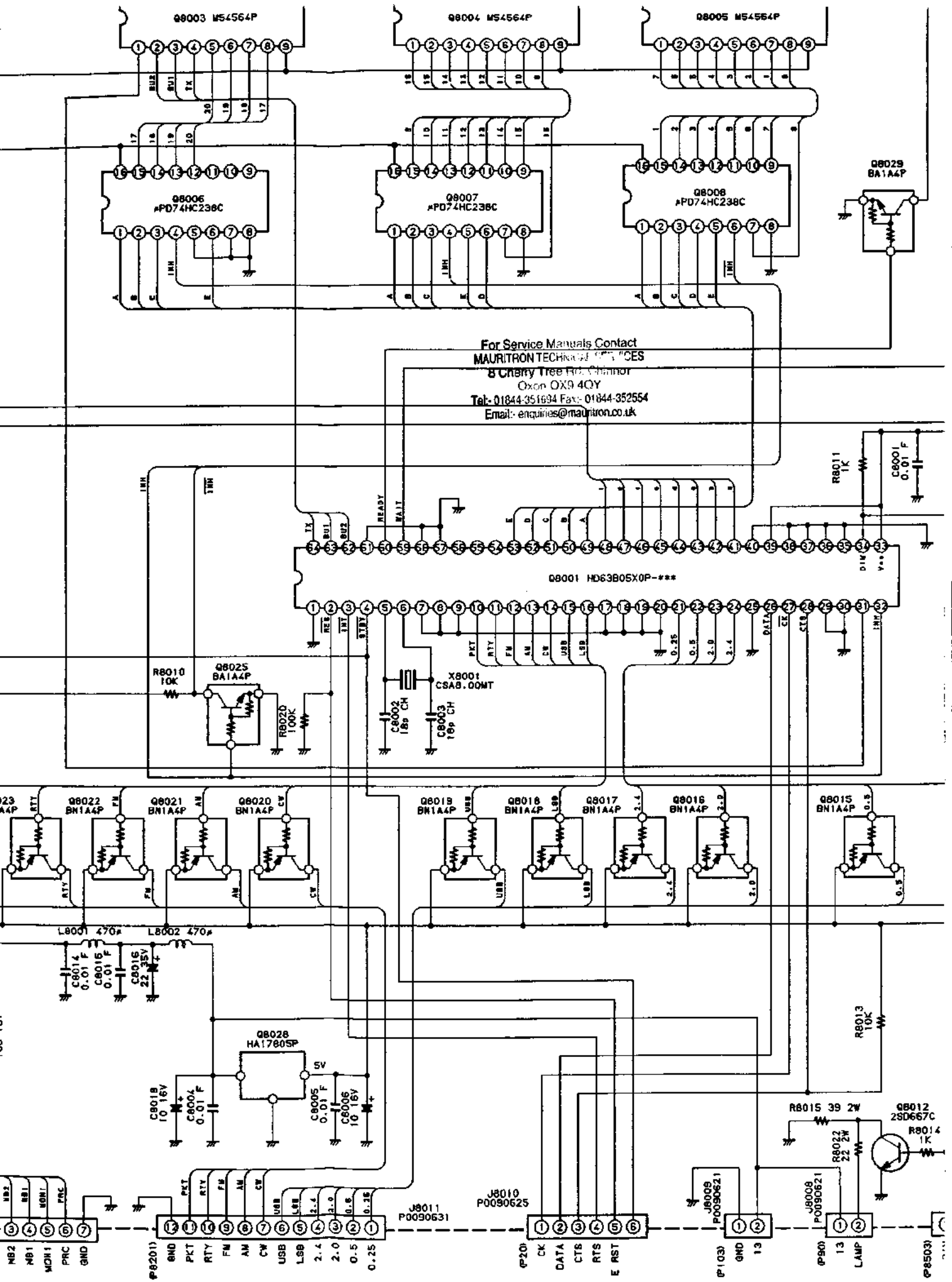

For Service Manuals Contact
MAURITRON TECHNICAL SERVICES
 8 Cherry Tree Fld, Chinnor
 Oxon OX9 4QY
 Tel: 01844 351694 Fax: 01844 352554
 Email: enquiries@mauritron.co.uk

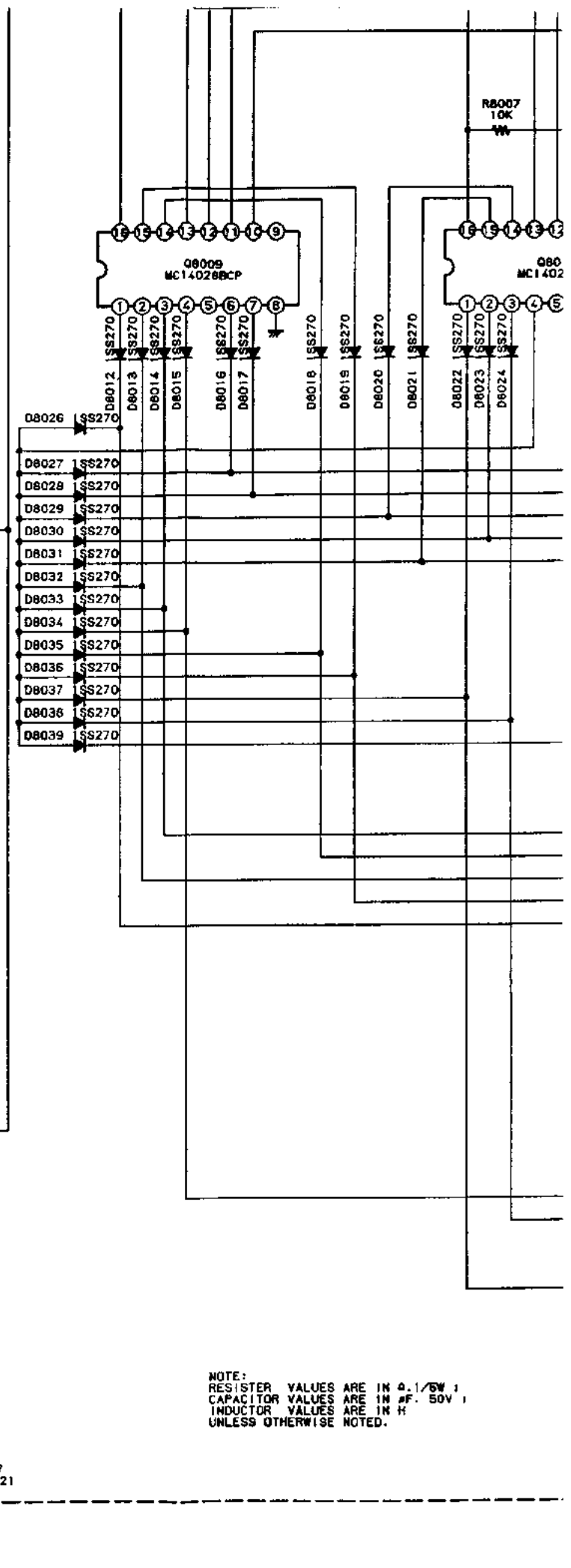
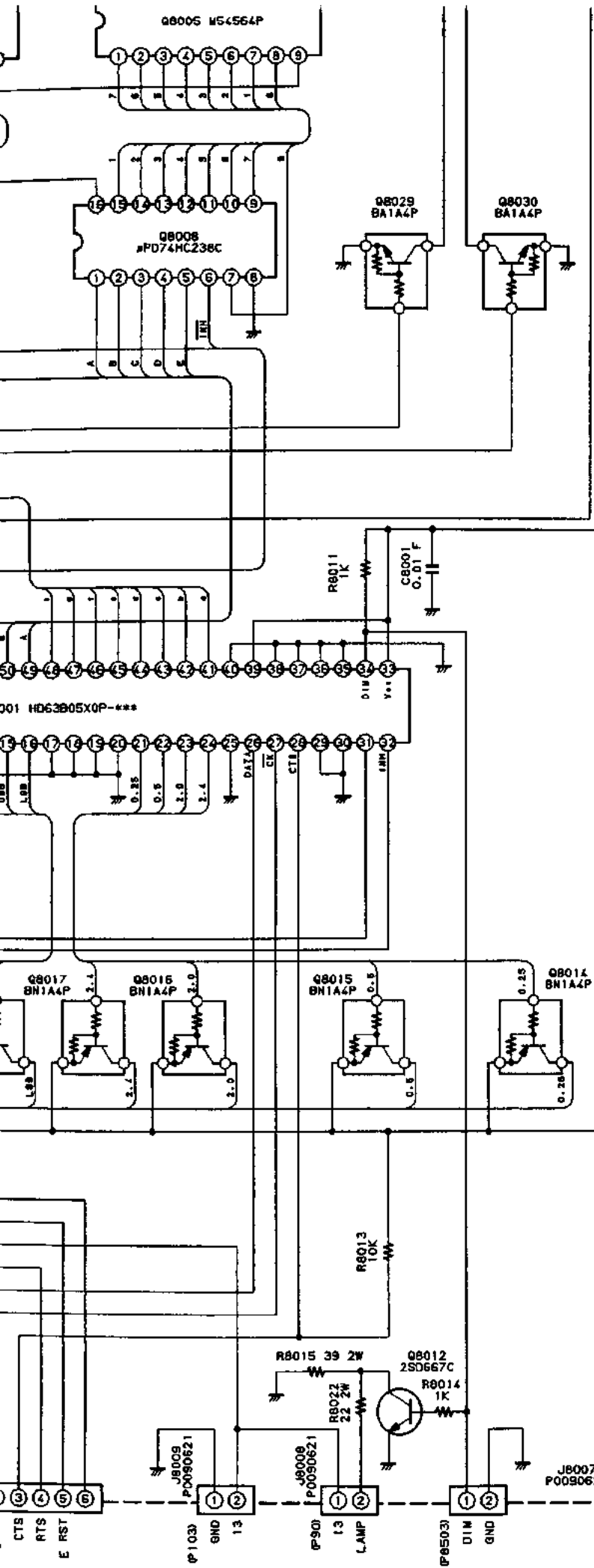

NOTE:
 RESISTOR VALUES ARE IN Ω, 1/8W, 1
 CAPACITOR VALUES ARE IN μF, 50V, 1
 INDUCTOR VALUES ARE IN H
 UNLESS OTHERWISE NOTED.

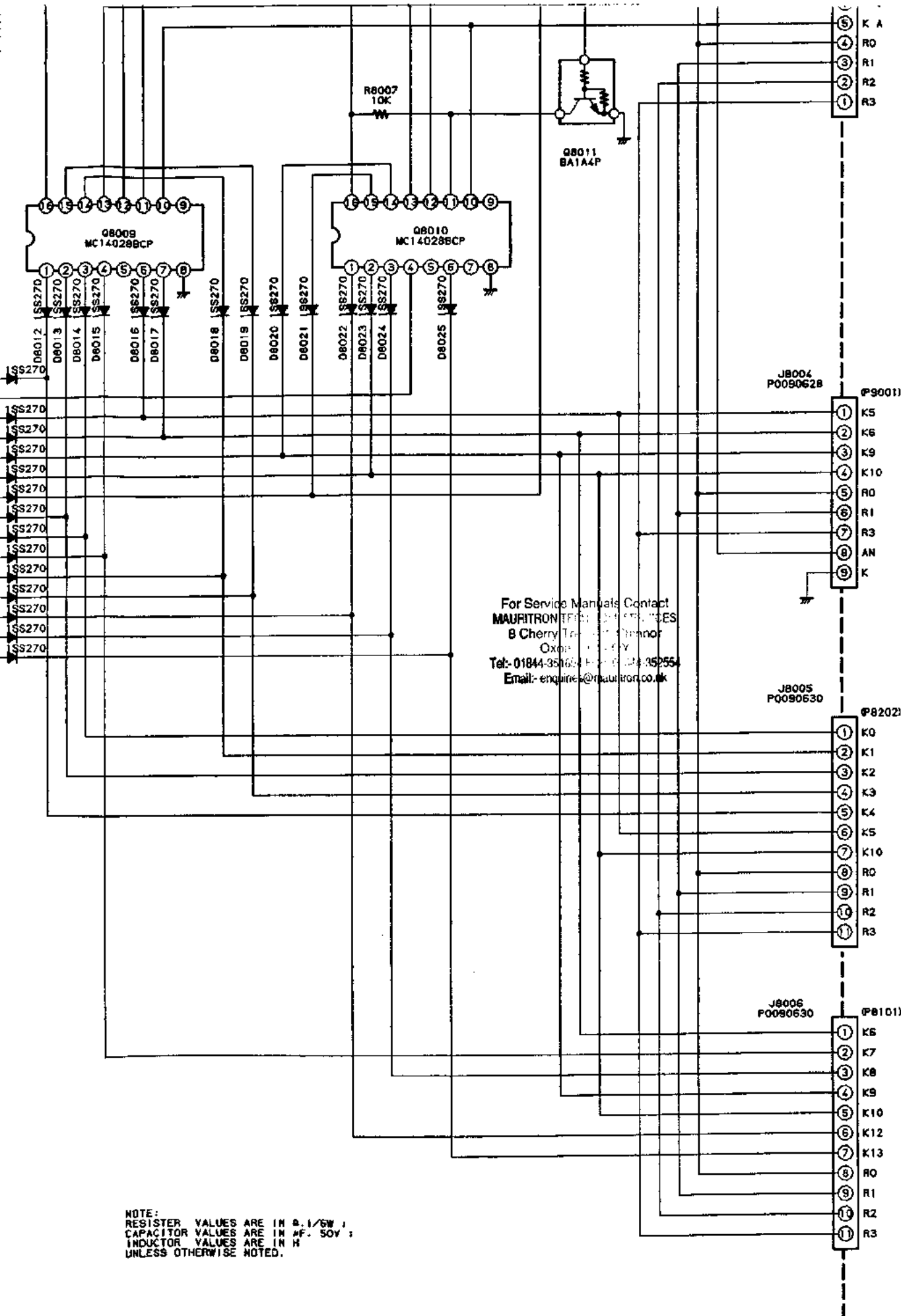

NOTE:
 RESISTOR VALUES ARE IN Ω, kΩ, MΩ;
 CAPACITOR VALUES ARE IN pF, nF, μF, 50V;
 INDUCTOR VALUES ARE IN mH
 UNLESS OTHERWISE NOTED.

PS Unit Parts List

ADD	CODE NO	DESCRIPTION	DEVICE	TYP	VAL
** UNIT NAME : PS-UNIT					
C	7601	K28179002 CERAMIC CAP.	UP050F473Z-A-B	0.047uF	50V F
C	7602	K28179002 CERAMIC CAP.	UP050F473Z-A-B	0.047uF	50V F
C	7603	K46170025 AL.ELECTRO.CAP.	50V101M8X11TR5	100uF	50V
C	7604	K28179002 CERAMIC CAP.	UP050F473Z-A-B	0.047uF	50V F
C	7605	K28179002 CERAMIC CAP.	UP050F473Z-A-B	0.047uF	50V F
C	7606	K46170021 AL.ELECTRO.CAP.	50V100M5X11TR5	10uF	50V
C	7607	K26140725 CERAMIC CAP.	UAT10X104K6L36VC	0.1uF	25V X
C	7608	K28129001 CERAMIC CAP.	EP050Y103N-A	0.01uF	16V Y
C	7609	K28129001 CERAMIC CAP.	EP050Y103N-A	0.01uF	16V Y
C	7610	K28129001 CERAMIC CAP.	EP050Y103N-A	0.01uF	16V Y
C	7611	K46100005 AL.ELECTRO.CAP.	10V221M6X11TR5	220uF	10V
C	7612	K28129001 CERAMIC CAP.	EP050Y103N-A	0.01uF	16V Y
C	7613	K28179002 CERAMIC CAP.	UP050F473Z-A-B	0.047uF	50V F
C	7614	K28179002 CERAMIC CAP.	UP050F473Z-A-B	0.047uF	50V F
C	7615	K46170017 AL.ELECTRO.CAP.	50V010M5X11TR5	1uF	50V
C	7616	K26140717 CERAMIC CAP.	UAT06X223K6L36VC	0.022uF	25V X
C	7617	K46140005 AL.ELECTRO.CAP.	25V101M6X11TR5	100uF	25V
C	7618	K28179002 CERAMIC CAP.	UP050F473Z-A-B	0.047uF	50V F
C	7619	K46170021 AL.ELECTRO.CAP.	50V100M5X11TR5	10uF	50V
C	7620	K28179002 CERAMIC CAP.	UP050F473Z-A-B	0.047uF	50V F
C	7621	K40149037 AL.ELECTRO.CAP.	RE2-25V471M	470UF	25V
C	7622	K28179002 CERAMIC CAP.	UP050F473Z-A-B	0.047uF	50V F
C	7623	K46140004 AL.ELECTRO.CAP.	25V470M5X11TR5	47uF	25V
C	7624	K28179002 CERAMIC CAP.	UP050F473Z-A-B	0.047uF	50V F
C	7625	K46140004 AL.ELECTRO.CAP.	25V470M5X11TR5	47uF	25V
C	7626	K28179002 CERAMIC CAP.	UP050F473Z-A-B	0.047uF	50V F
C	7627	K46170021 AL.ELECTRO.CAP.	50V100M5X11TR5	10uF	50V
C	7628	K28179002 CERAMIC CAP.	UP050F473Z-A-B	0.047uF	50V F
C	7629	K28129001 CERAMIC CAP.	EP050Y103N-A	0.01uF	16V Y
C	7630	K40149037 AL.ELECTRO.CAP.	RE2-25V471M	470UF	25V
C	7631	K28179002 CERAMIC CAP.	UP050F473Z-A-B	0.047uF	50V F
D	7601	G3090044 SCR CW12B	CW12B		
D	7602	G2060006 DIODE	RD4.7EB2-T1		
D	7603	G2060004 DIODE	1SS270TJ		
D	7604	G2060004 DIODE	1SS270TJ		
D	7605	G2060004 DIODE	1SS270TJ		
D	7606	G2060004 DIODE	1SS270TJ		
D	7608	G2060004 DIODE	1SS270TJ		
D	7609	G2060004 DIODE	1SS270TJ		
D	7610	G2090111 DIODE	HZ6C1		
J	7601	R0100970	B4100970		
J	7602	R0100970	B4100970		
J	7603	P0090621 CONNECTOR	SC25-02WS		
J	7604	P0090622 CONNECTOR	SC25-03WS		
J	7605	R0100970	B4100970		
J	7606	R0100970	B4100970		
J	7607	P0090621 CONNECTOR	SC25-02WS		
J	7608	P0090621 CONNECTOR	SC25-02WS		
J	7609	P0090621 CONNECTOR	SC25-02WS		
J	7610	P0090621 CONNECTOR	SC25-02WS		
J	7611	P0090623 CONNECTOR	SC25-04WS		
J	7612	P0090625 CONNECTOR	SC25-06WS		
J	7613	P0090621 CONNECTOR	SC25-02WS		
J	7614	P0090621 CONNECTOR	SC25-02WS		
Q	7601	G3329870Q TRANSISTOR	2SC2987Q		
Q	7602	G3329870Q TRANSISTOR	2SC2987Q		
Q	7603	G3329870Q TRANSISTOR	2SC2987Q		
Q	7604	G3309454Q TRANSISTOR	2SC945AQ-T		
Q	7605	G3107334Q TRANSISTOR	2SA733AQ(T)		
Q	7606	G3107334Q TRANSISTOR	2SA733AQ(T)		
Q	7607	G3205950Q TRANSISTOR	2SB5950		
Q	7608	G3107334Q TRANSISTOR	2SA733AQ(T)		
Q	7609	G3107334Q TRANSISTOR	2SA733AQ(T)		
Q	7610	G1090649 IC	M5218L		
Q	7611	G1090649 IC	M5218L		
Q	7612	G3406674D TRANSISTOR	2SD667D TZ		
Q	7613	G3309454Q TRANSISTOR	2SC945AQ-T		
Q	7614	G3050002 TRANSISTOR	BN1A4P-T		
Q	7615	G3407170Y TRANSISTOR	2SD717Y		
Q	7616	G3109500Y TRANSISTOR	2SA950Y		
Q	7617	G3110150G TRANSISTOR	2SA1015GR		
Q	7618	G1090946 IC	MC7809CT		
Q	7619	G1090946 IC	MC7809CT		
Q	7620	G1090973 IC	M5F79M09		
Q	7621	G3406674D TRANSISTOR	2SD667D TZ		
R	7601	J30376019 CEMENT RES. ERF-5AKOR1	ERF-5AKOR1	0.1	5W
R	7602	J30376019 CEMENT RES. ERF-5AKOR1	ERF-5AKOR1	0.1	5W
R	7603	J30376019 CEMENT RES. ERF-5AKOR1	ERF-5AKOR1	0.1	5W
R	7604	J07225470 CARBON FILM RES.	RD16TPJ470	47	1/6W
R	7605	J07225222 CARBON FILM RES.	RD16TPJ222	2.2K	1/6W
R	7606	J07225223 CARBON FILM RES.	RD16TPJ223	22K	1/6W
R	7607	J07225473 CARBON FILM RES.	RD16TPJ473	47K	1/6W

For Service Manuals Contact
MAURITRON TECHNICAL SERVICES
 8 Cherry Tree Rd, Chinnor
 Oxon OX9 4QY
 Tel: 01844-351604 Fax: 01844-352554
 Email: enquiries@mauritron.co.uk

PS Unit Parts List

ADD	CODE NO	DESCRIPTION	DEVICE	TYP	VAL
R 7608	J07225103	CARBON FILM RES.	RD16TPJ103 10K	10K	1/6W
R 7609	J07225222	CARBON FILM RES.	RD16TPJ222 2.2K	2.2K	1/6W
R 7610	J07225472	CARBON FILM RES.	RD16TPJ472 4.7K	4.7K	1/6W
R 7611	J07225472	CARBON FILM RES.	RD16TPJ472 4.7K	4.7K	1/6W
R 7612	J07225473	CARBON FILM RES.	RD16TPJ473 47K	47K	1/6W
R 7613	J07225222	CARBON FILM RES.	RD16TPJ222 2.2K	2.2K	1/6W
R 7614	J07225222	CARBON FILM RES.	RD16TPJ222 2.2K	2.2K	1/6W
R 7615	J07225222	CARBON FILM RES.	RD16TPJ222 2.2K	2.2K	1/6W
R 7616	J07225102	CARBON FILM RES.	RD16TPJ102 1K	1K	1/6W
R 7617	J07225103	CARBON FILM RES.	RD16TPJ103 10K	10K	1/6W
R 7618	J07225472	CARBON FILM RES.	RD16TPJ472 4.7K	4.7K	1/6W
R 7619	J07225272	CARBON FILM RES.	RD16TPJ272 2.7K	2.7K	1/6W
R 7620	J07225103	CARBON FILM RES.	RD16TPJ103 10K	10K	1/6W
R 7621	J07225222	CARBON FILM RES.	RD16TPJ222 2.2K	2.2K	1/6W
R 7622	J07225334	CARBON FILM RES.	RD16TPJ334 330K	330K	1/6W
R 7623	J07225103	CARBON FILM RES.	RD16TPJ103 10K	10K	1/6W
R 7624	J07225105	CARBON FILM RES.	RD16TPJ105 1M	1M	1/6W
R 7625	J07225154	CARBON FILM RES.	RD16TPJ154 150K	150K	1/6W
R 7626	J07225473	CARBON FILM RES.	RD16TPJ473 47K	47K	1/6W
R 7627	J07225473	CARBON FILM RES.	RD16TPJ473 47K	47K	1/6W
R 7628	J07225101	CARBON FILM RES.	RD16TPJ101 100	100	1/6W
R 7629	J07225222	CARBON FILM RES.	RD16TPJ222 2.2K	2.2K	1/6W
R 7630	J07225101	CARBON FILM RES.	RD16TPJ101 100	100	1/6W
R 7631	J07225472	CARBON FILM RES.	RD16TPJ472 4.7K	4.7K	1/6W
R 7632	J07225103	CARBON FILM RES.	RD16TPJ103 10K	10K	1/6W
R 7633	J07225103	CARBON FILM RES.	RD16TPJ103 10K	10K	1/6W
R 7634	J07225104	CARBON FILM RES.	RD16TPJ104 100K	100K	1/6W
R 7635	J07225473	CARBON FILM RES.	RD16TPJ473 47K	47K	1/6W
R 7636	J07225473	CARBON FILM RES.	RD16TPJ473 47K	47K	1/6W
R 7637	J07225103	CARBON FILM RES.	RD16TPJ103 10K	10K	1/6W
R 7638	J07225472	CARBON FILM RES.	RD16TPJ472 4.7K	4.7K	1/6W
R 7639	J07225222	CARBON FILM RES.	RD16TPJ222 2.2K	2.2K	1/6W
R 7640	J22359003	METAL FILM RES.	ERG-3SJ270	27	3W
R 7641	J07225271	CARBON FILM RES.	RD16TPJ271 270	270	1/6W
R 7642	J07225222	CARBON FILM RES.	RD16TPJ222 2.2K	2.2K	1/6W
R 7643	J07225271	CARBON FILM RES.	RD16TPJ271 270	270	1/6W
R 7644	J30335029	CEMENT RES. 2W 0.2-OHM J	2W 0.2*-A J	0.2	2W J
R 7645	J07225472	CARBON FILM RES.	RD16TPJ472 4.7K	4.7K	1/6W
R 7646	J07225222	CARBON FILM RES.	RD16TPJ222 2.2K	2.2K	1/6W
R 7647	J07225821	CARBON FILM RES.	RD16TPJ821 820	820	1/6W
R 7648	J07225472	CARBON FILM RES.	RD16TPJ472 4.7K	4.7K	1/6W
R 7649	J07225332	CARBON FILM RES.	RD16TPJ332 3.3K	3.3K	1/6W
R 7650	J22359004	METAL FILM RES.	ERG-3SJ121 120	120	3W
R 7651	J07225101	CARBON FILM RES.	RD16TPJ101 100	100	1/6W
R 7652	J07225101	CARBON FILM RES.	RD16TPJ101 100	100	1/6W
TH7601	G9090028	THERMISTOR	112201-2		
TH7602	G9090043	THERMISTOR	112103-2		
TH7604	G9090026	THERMISTOR	112201-2		
VR7601	J50709331	POT.	H1052A004-330B	330B	
VR7602	J50709472	POT.	H1052A011-4.7KB	4.7KB	
VR7603	J50709472	POT.	H1052A011-4.7KB	4.7KB	

For Service Manuals Contact
MAURITRON TECHNICAL SERVICES
 8 Cherry Tree Rd. Chinnor
 Oxon OX9 4QY
 Tel: 01844-351694 Fax: 01844-352554
 Email: enquiries@mauritron.co.uk

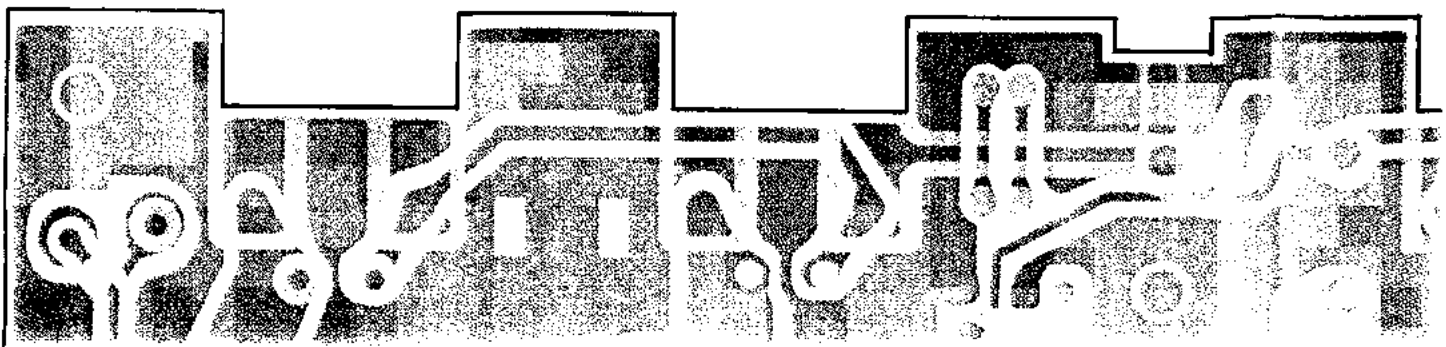
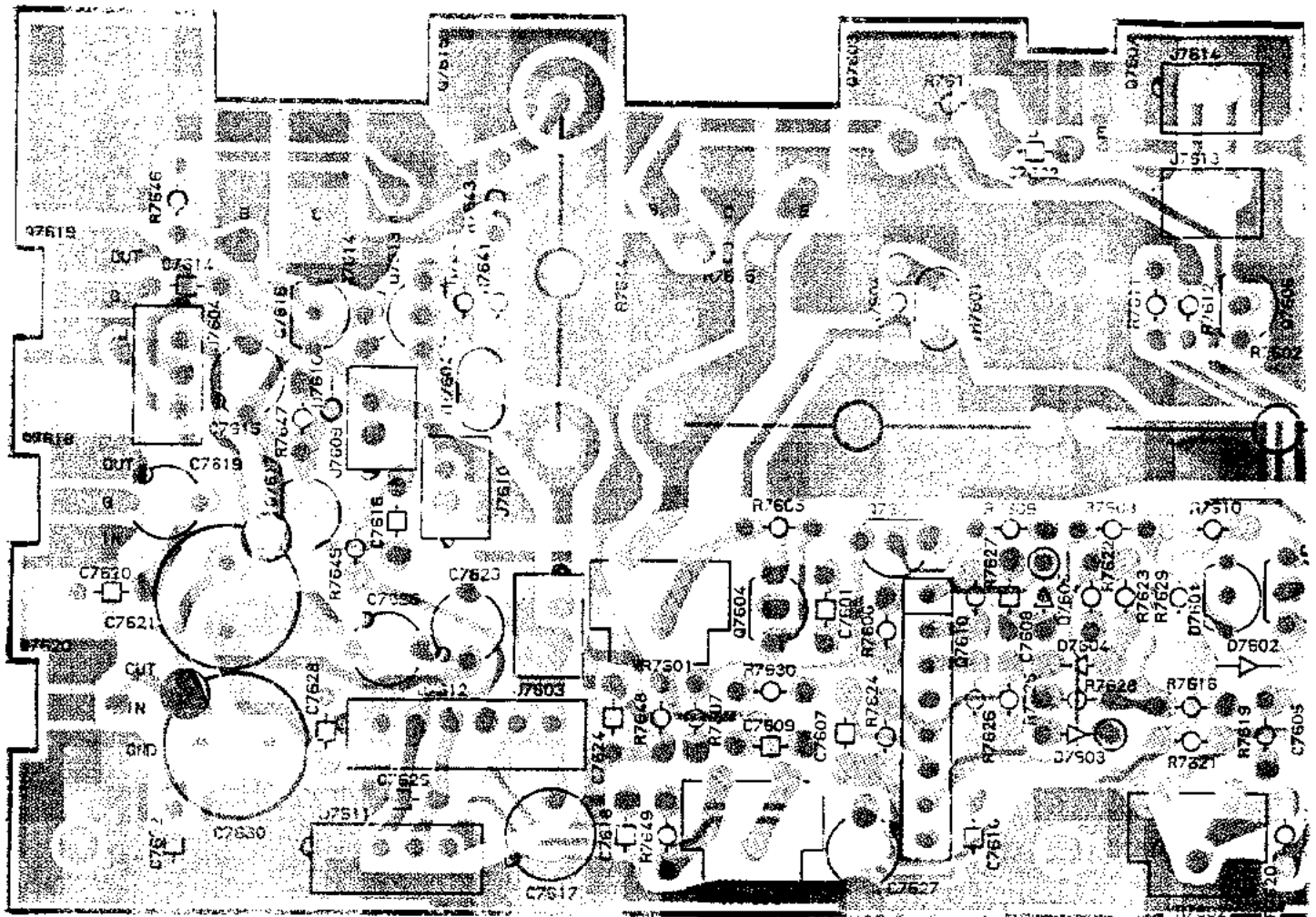

For Service Manuals Contact
MAURITRON TECHNICAL SERVICES
8 Cherry Tree Rd, Chinnor
Oxon OX9 4QY
Tel: 01844-351694 Fax: 01844-352554
Email: enquiries@mauritron.co.uk

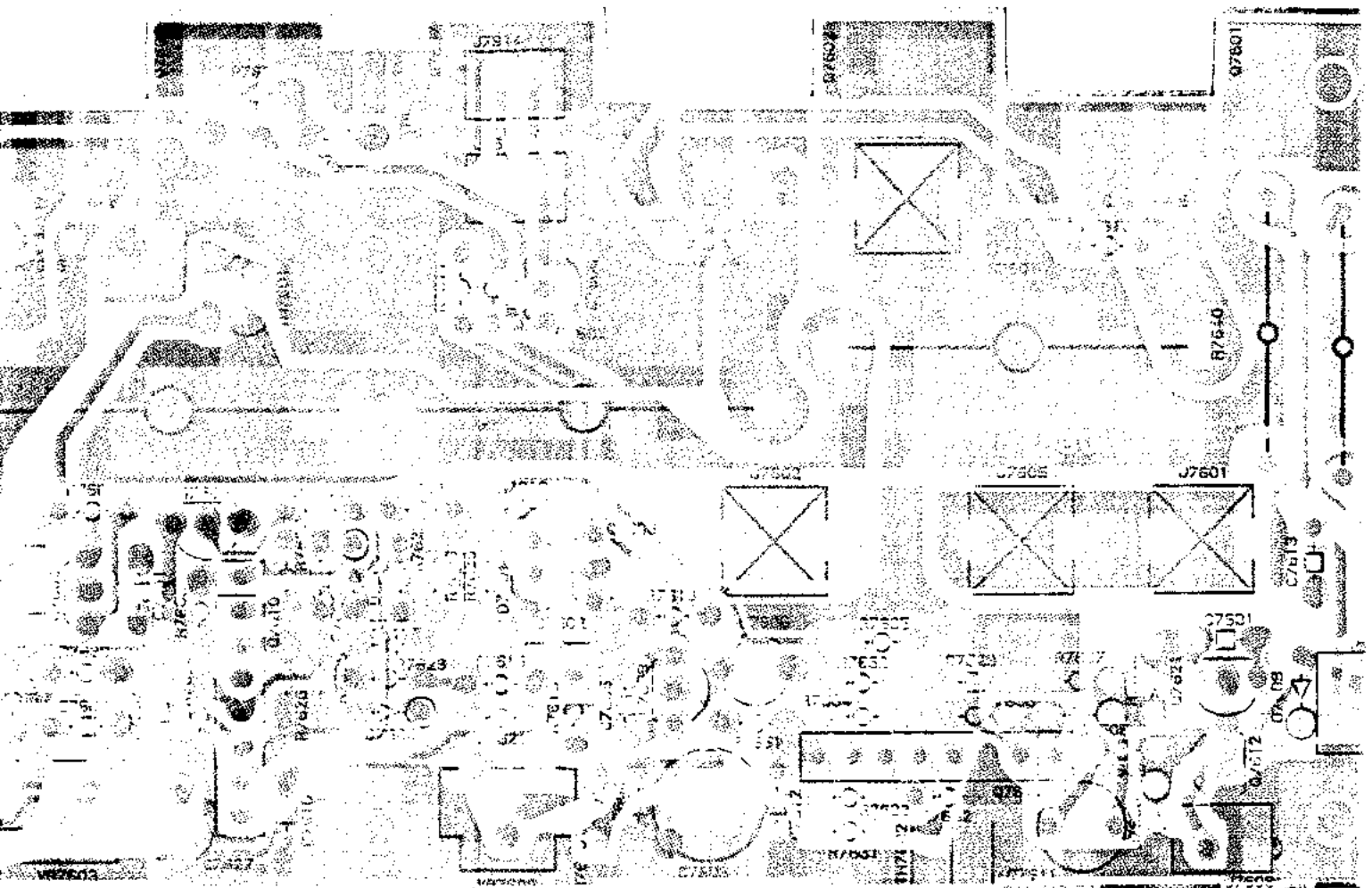

(obverse view of "component" side)

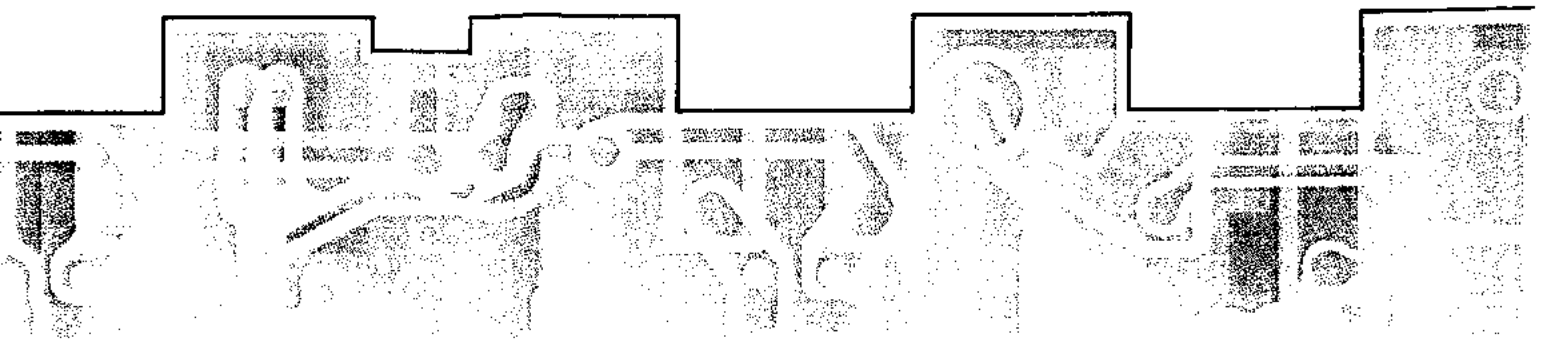

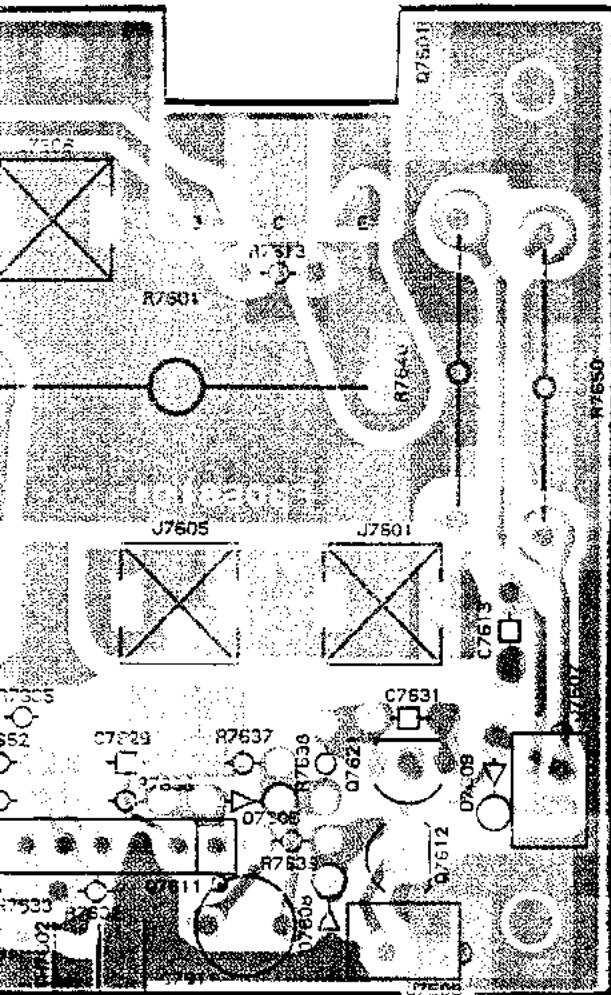

(obverse view of "component" side)

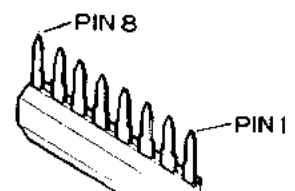
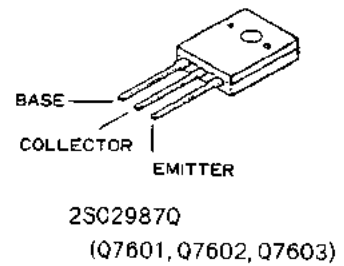
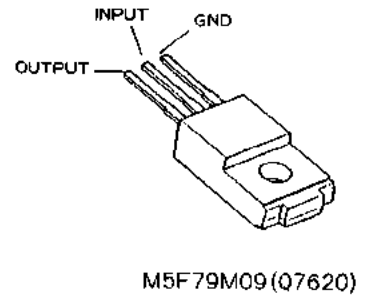
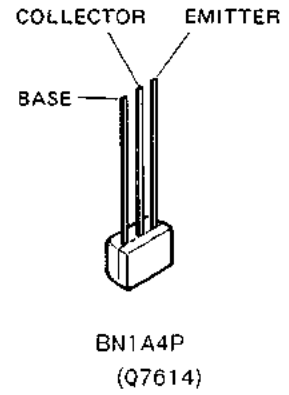
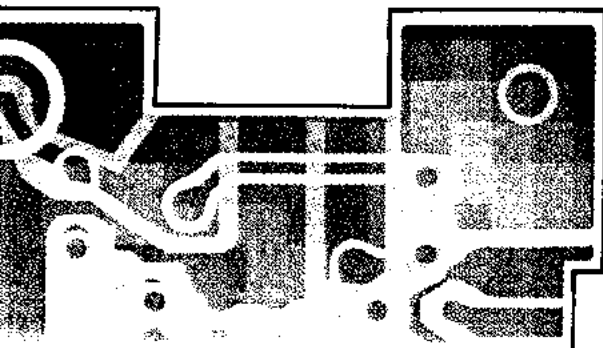

PS Unit Board Layout

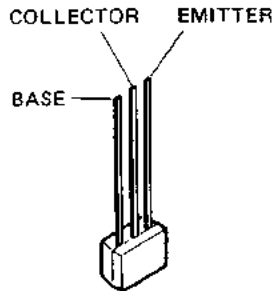

BN1A4P
(Q7614)

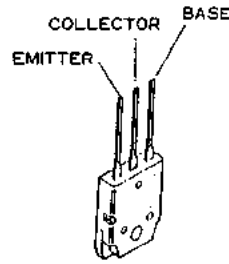

2SD717Y (Q7615)

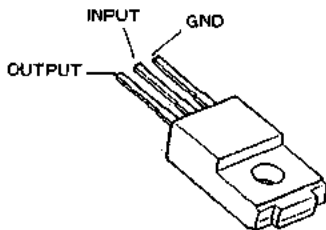

M5F79M09 (Q7620)

For Service Manuals Contact
MAURITRON TECHNICAL SERVICES
 8 Cherry Tree Rd, Chinnor
 Oxon OX9 4QY
 Tel: 01844-351694 Fax: 01844-352554
 Email: enquiries@mauritron.co.uk

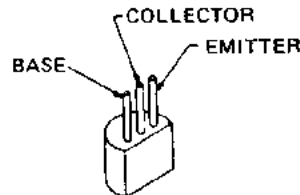

2SA733AQ
(Q7605, Q7606,
Q7608, Q7609)

2SC945AQ
(Q7604, Q7613)

2SD667D(TZ)
(Q7612, Q7621)

2SA950Y
(Q7616)

2SA1015GR
(Q7617)

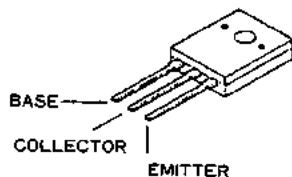

2SC2987Q
(Q7601, Q7602, Q7603)

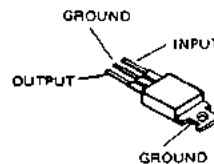

L7809
(Q7618, Q7619)

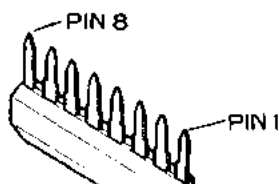

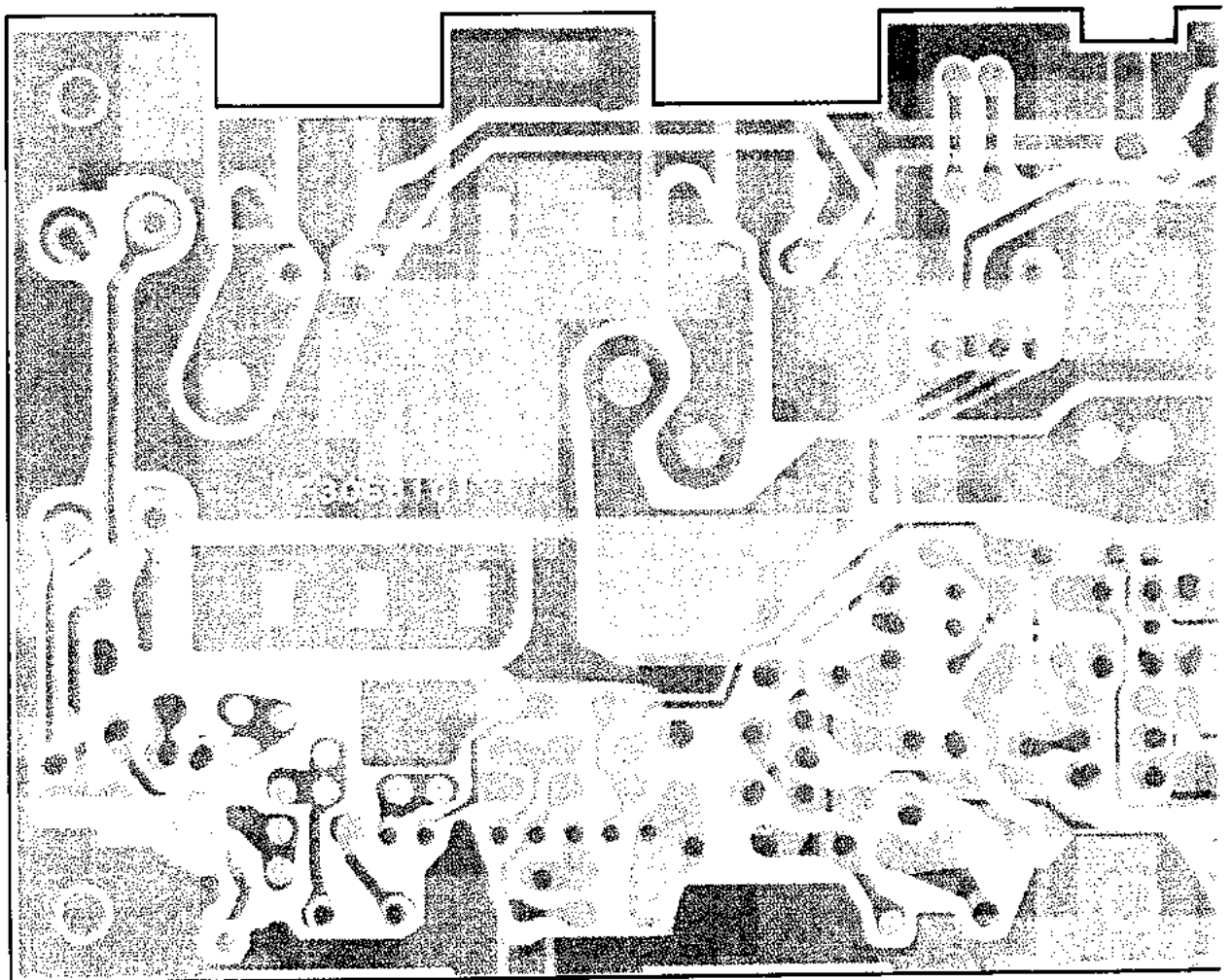
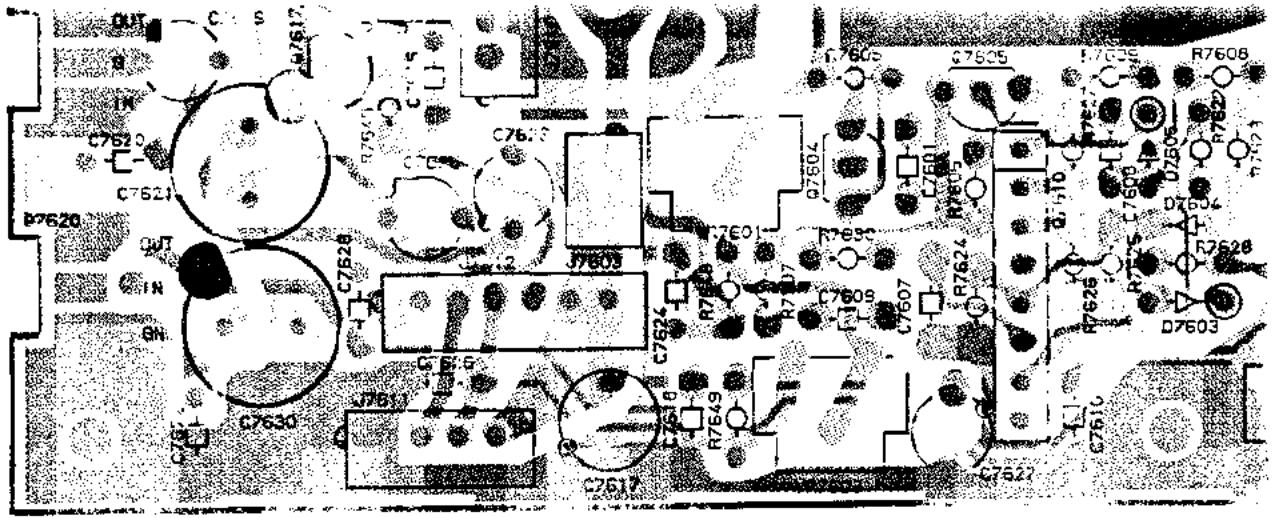

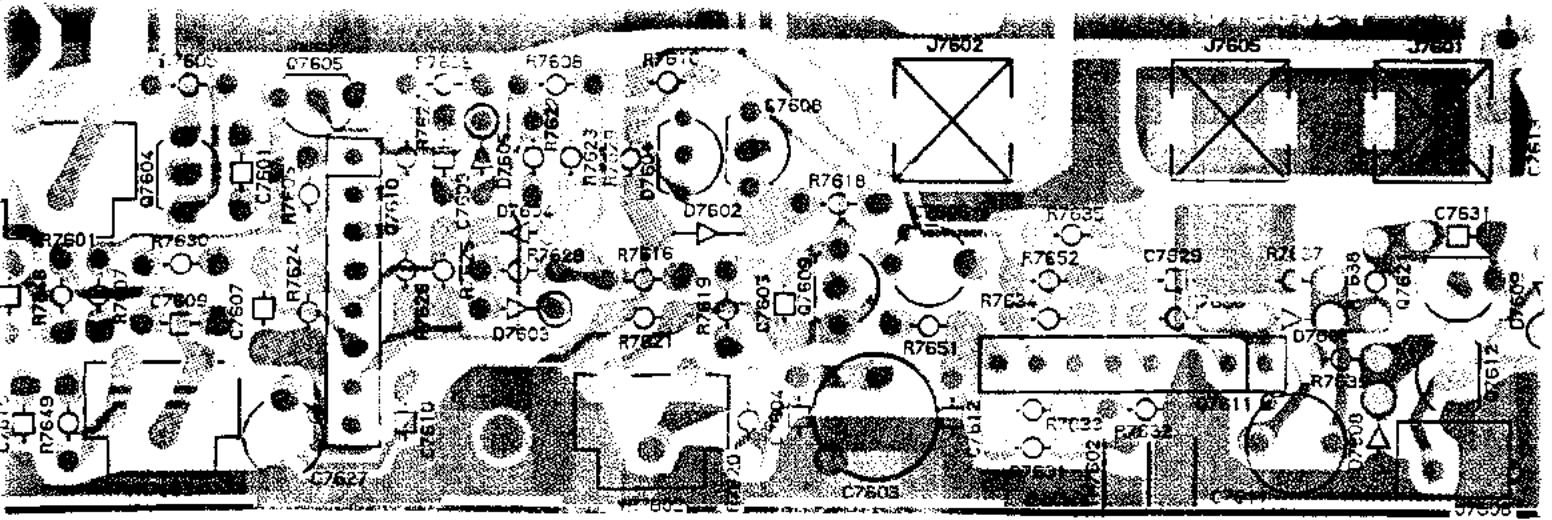

(obverse view of "component")

For Service Manuals Contact
MAURITRON TECHNICAL SERVICES
 8 Cherry Tree Road, Chinnor
 Oxon OX9 4DY
 Tel: 01844-351694 Fax: 01844-352594
 Email: enquiries@mauritron.co.uk

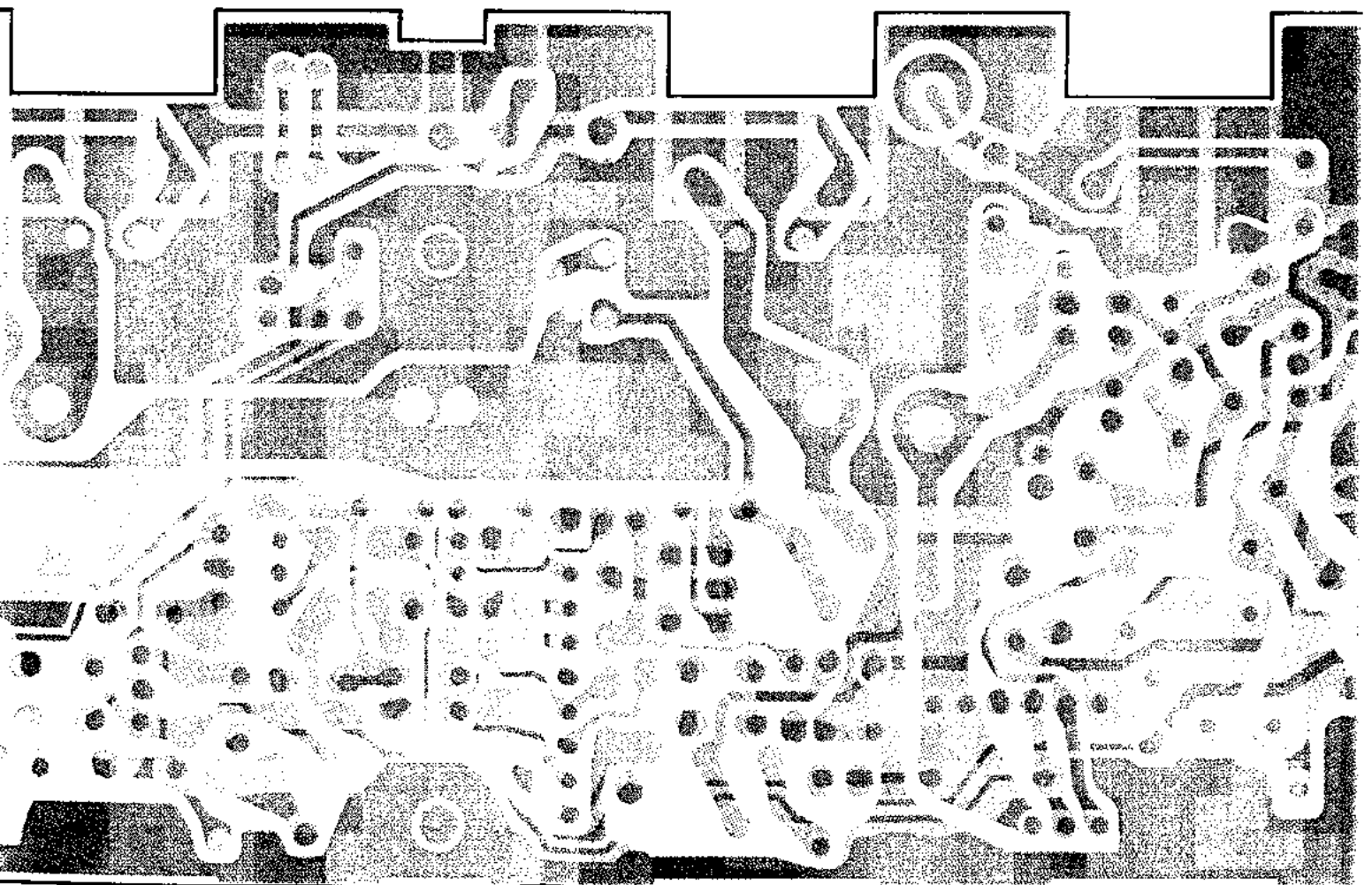

(obverse view of "solder")

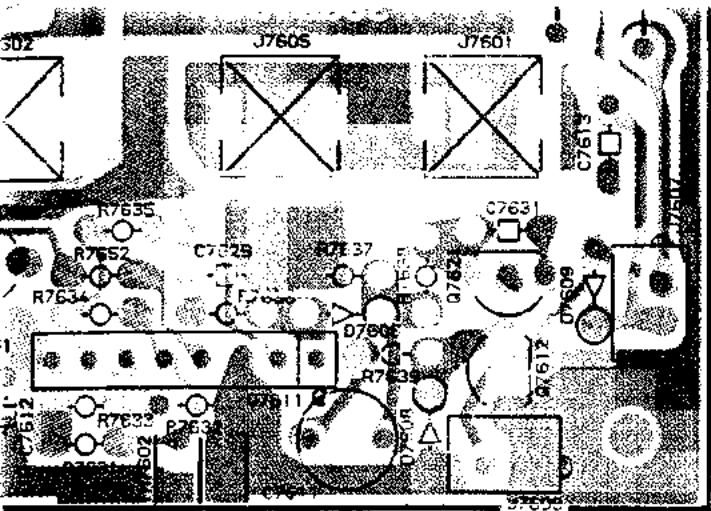

(obverse view of "component" side)

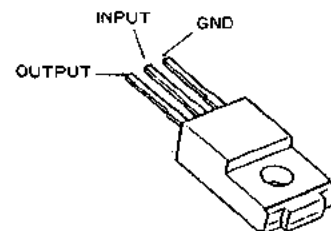

M5F79M09 (Q7620)

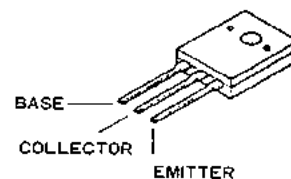

25C29870
(Q7601, Q7602, Q7603)

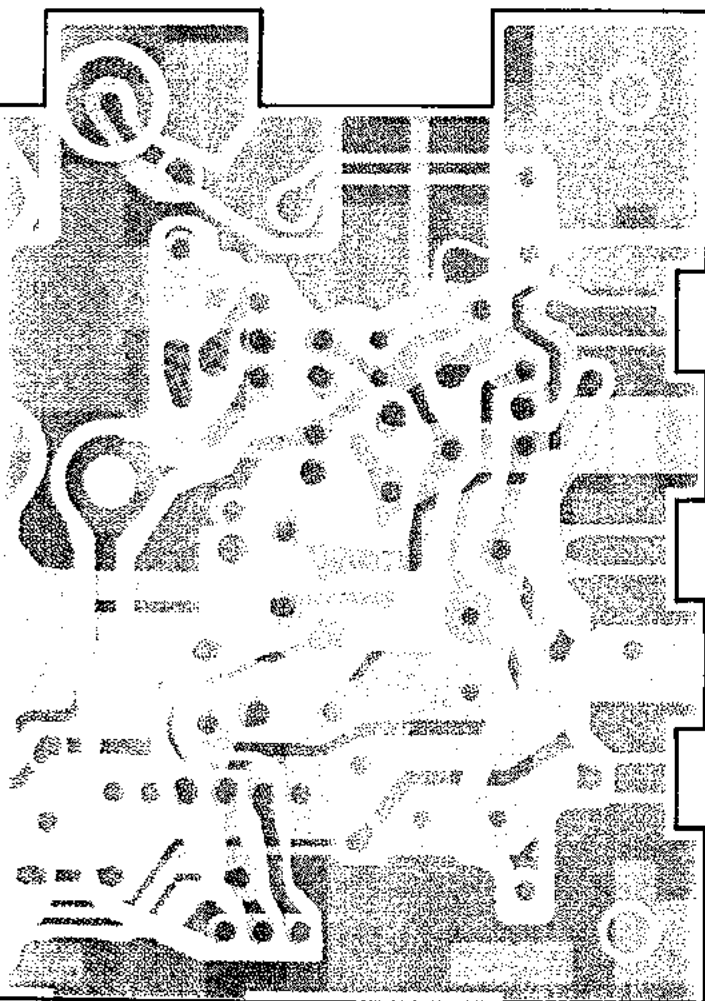

(obverse view of "solder" side)

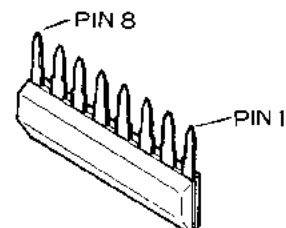

M5218L (Q7610, Q7611)

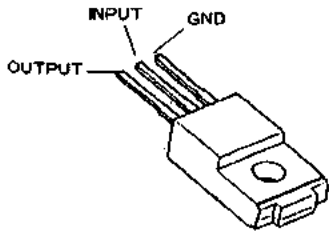

M5F79M09 (Q7620)

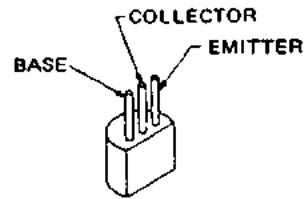

2SA733A0
(Q7605, Q7606,
Q7608, Q7609)

2SC945A0
(Q7604, Q7613)
2SD667D (TZ)
(Q7612, Q7621)

2SA950Y
(Q7616)
2SA1015GR
(Q7617)

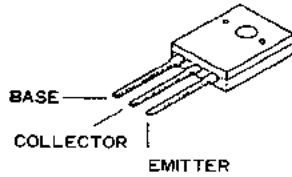

2SC2987Q
(Q7601, Q7602, Q7603)

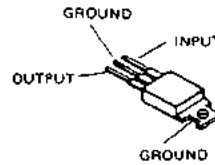

L7809
(Q7618, Q7619)

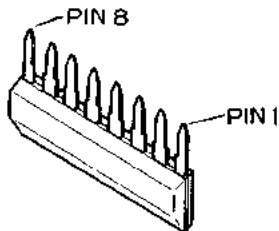

M5218L (Q7610, Q7611)

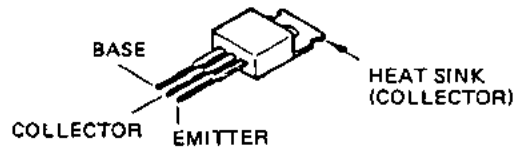

2SB5950
(Q7607)

For Service Manuals Contact
MAURITRON TECHNICAL SERVICES
8 Cherry Tree Rd, Chinnor
Oxon OX3 4QY
Tel: 01844-351694 Fax: 01844-352554
Email: enquiries@maurtron.co.uk

For Service Manuals Contact
MAURITRON TECHNICAL SERVICES
 8 Cherry Tree Rd. Chinnor
 Oxon OX9 4QY
 Tel:- 01844-351694 Fax:- 01844-352554
 Email:- enquiries@mauritron.co.uk

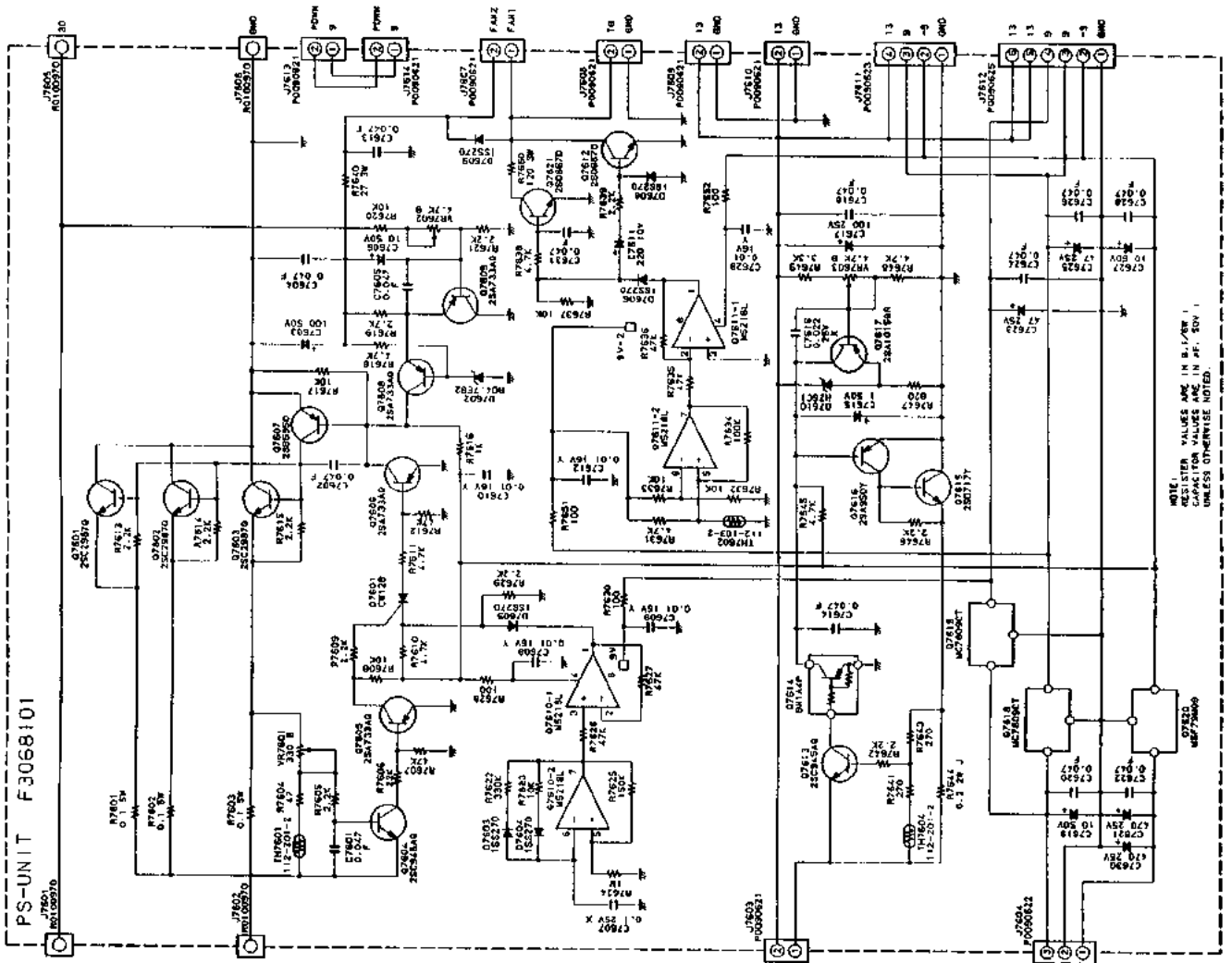

Rectifier(RECT) Unit Parts List

ADD	CODE NO	DESCRIPTION	DEVICE	TYP	VAL
C	9301	K12329001 CERAMIC CAP.	ECKDNS103ME	0.01uF	1600V
C	9302	K12329001 CERAMIC CAP.	ECKDNS103ME	0.01uF	1600V
C	9303	K43180001 AL. ELECTRO. CAP.	63L18000	18000uF	63V
C	9304	K43180001 AL. ELECTRO. CAP.	63L18000	18000uF	63V
C	9305	K43160004 AL. ELECTRO. CAP.	35L12000	12000uF	35V
C	9306	K43140006 AL. ELECTRO. CAP.	25L10000	10000uF	25V
D	9301	G2090361 DIODE	S25VB20		
D	9302	G2090022 DIODE	S5VB10		
D	9303	G2090031 DIODE	S4VB10		
F	9301	Q0000008 FUSE			100V 2W
F	9301	Q0000008 FUSE			110V 2W
F	9301	Q0000008 FUSE			117V 2W
F	9301	Q0000008 FUSE			117V 3W
F	9301	Q0000039 FUSE			220V 2W
F	9301	Q0000039 FUSE			220V 3W
F	9301	Q0000039 FUSE			234V 3W
F	9301	Q0000039 FUSE			234V 3WP
J	9301	P0090703 CONNECTOR			
JP	9301	T9317842 WIRE ASSY 2710			
JP	9302	T9317843 WIRE ASSY 2710			
JP	9303	T9317844 WIRE ASSY 2710			
JP	9304	T9317869 WIRE ASSY 2710			
P	9301	T9205916 WIRE ASSY 2710			
P	9302	T9205917 WIRE ASSY 2710			
P	9303	T9205895 WIRE ASSY 2710			
P	9304	T9205896 WIRE ASSY 2710			
P	9305	T9205865 WIRE ASSY 2710			
R	9301	J20356102 METAL FILM RES.	RS3B	1K	3W K

Notes

For Service Manuals Contact
MAURITRON TECHNICAL SERVICES
8 Cherry Tree Rd, Chinnor
Oxon OX9 4QY
Tel: 01844-351694 Fax: 01844-352554
Email: enquiries@mauritron.co.uk

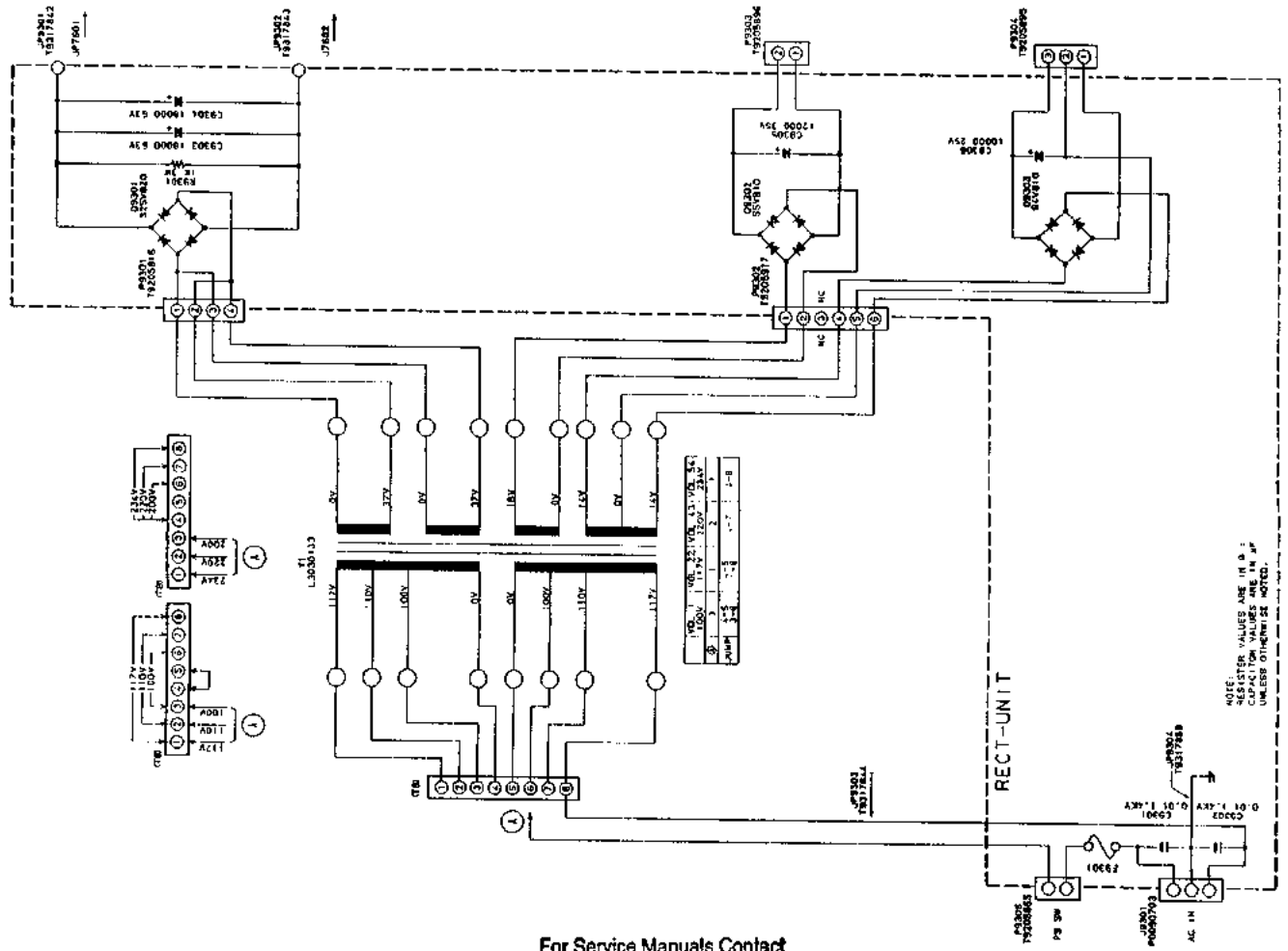

For Service Manuals Contact
MAURITRON TECHNICAL SERVICES
 8 Cherry Tree Rd, Chinnor
 Oxon OX9 4OY
 Tel: 01844-61854 Fax: 01844-352554
 Email: enquires@maurtron.co.uk

Switch(SW) A Unit Parts List

ADD	CODE NO	DESCRIPTION	DEVICE	TYP VAL		
** UNIT NAME : SW-A-UNIT						
BT8301	Q9000268	LITHIUM BATTERY	CR2032-HM4			
C 8301	K28129001	CERAMIC CAP.	EP050Y103N-A	0.01uF	16V	Y
C 8302	K46170030	AL.ELECTRO.CAP.	50V010M4X7TR2	1uF	50V	
C 8303	K46170030	AL.ELECTRO.CAP.	50V010M4X7TR2	1uF	50V	
C 8304	K28129006	CERAMIC CAP.	EP050X682M-A-B	0.0068uF	16V	X
C 8305	K28129004	CERAMIC CAP.	EP050X332M-A-B	0.0033uF	16V	X
C 8306	K46170030	AL.ELECTRO.CAP.	50V010M4X7TR2	1uF	50V	
C 8307	K46120005	AL.ELECTRO.CAP.	16V220H5X7TR2	22uF	16V	
C 8308	K28129005	CERAMIC CAP.	EP050X472M-A-B	0.0047uF	16V	X
C 8309	K46160004	AL.ELECTRO.CAP.	35V4R7M4X7TR2	4.7uF	35V	
C 8310	K28179002	CERAMIC CAP.	UP050F473Z-A-B	0.047uF	50V	F
C 8311	K28179002	CERAMIC CAP.	UP050F473Z-A-B	0.047uF	50V	F
C 8312	K46120004	AL.ELECTRO.CAP.	16V100M4X7TR2	10uF	16V	
C 8313	K28179002	CERAMIC CAP.	UP050F473Z-A-B	0.047uF	50V	F
C 8314	K46120004	AL.ELECTRO.CAP.	16V100M4X7TR2	10uF	16V	
C 8315	K28179002	CERAMIC CAP.	UP050F473Z-A-B	0.047uF	50V	F
C 8316	K26170727	CERAMIC CAP.	DD308-979F104250	0.1uF	50V	F
C 8317	K28129001	CERAMIC CAP.	EP050Y103N-A	0.01uF	16V	Y
D 8301	G2090118	DIODE	1SS97			
D 8302	G2060004	DIODE	1SS270TJ			
D 8303	G2060004	DIODE	1SS270TJ			
D 8304	G2060004	DIODE	1SS270TJ			
D 8305	G2090188	DIODE	HZ5C1			
J 8301	P0090716	CONNECTOR	SC25-09WL			
J 8302	P0090717	CONNECTOR	SC25-10WL			
J 8303	P0090712	CONNECTOR	SC25-02WL			
J 8304	P0090712	CONNECTOR	SC25-02WL			
J 8305	P0090712	CONNECTOR	SC25-02WL			
J 8306	P0090712	CONNECTOR	SC25-02WL			
J 8307	P0090712	CONNECTOR	SC25-02WL			
J 8308	P0090712	CONNECTOR	SC25-02WL			
J 8309	P0090637	CONNECTOR SC25-03WL	SC25-03WL			
J 8310	P0090712	CONNECTOR	SC25-02WL			
Q 8301	G1090988	IC	M5223L			
Q 8302	G1090988	IC	M5223L			
Q 8303	G1090988	IC	M5223L			
R 8301	J07225105	CARBON FILM RES.	RD16TPJ105	1M	1M	1/6W
R 8302	J07225222	CARBON FILM RES.	RD16TPJ222	2.2K	2.2K	1/6W
R 8303	J07225222	CARBON FILM RES.	RD16TPJ222	2.2K	2.2K	1/6W
R 8304	J07225272	CARBON FILM RES.	RD16TPJ272	2.7K	2.7K	1/6W
R 8305	J07225332	CARBON FILM RES.	RD16TPJ332	3.3K	3.3K	1/6W
R 8306	J07225332	CARBON FILM RES.	RD16TPJ332	3.3K	3.3K	1/6W
R 8307	J07225472	CARBON FILM RES.	RD16TPJ472	4.7K	4.7K	1/6W
R 8308	J07225472	CARBON FILM RES.	RD16TPJ472	4.7K	4.7K	1/6W
R 8309	J07225472	CARBON FILM RES.	RD16TPJ472	4.7K	4.7K	1/6W
R 8310	J07225123	CARBON FILM RES.	RD16TPJ123	12K	12K	1/6W
R 8311	J07225105	CARBON FILM RES.	RD16TPJ105	1M	1M	1/6W
R 8312	J07225123	CARBON FILM RES.	RD16TPJ123	12K	12K	1/6W
R 8313	J07225332	CARBON FILM RES.	RD16TPJ332	3.3K	3.3K	1/6W
R 8314	J07225335	CARBON FILM RES.	RD16TPJ335	3.3M	3.3M	1/6W
R 8315	J07225472	CARBON FILM RES.	RD16TPJ472	4.7K	4.7K	1/6W
R 8316	J07225472	CARBON FILM RES.	RD16TPJ472	4.7K	4.7K	1/6W
R 8317	J07225332	CARBON FILM RES.	RD16TPJ332	3.3K	3.3K	1/6W
R 8318	J07225473	CARBON FILM RES.	RD16TPJ473	47K	47K	1/6W
R 8319	J07225102	CARBON FILM RES.	RD16TPJ102	1K	1K	1/6W
R 8320	J07225474	CARBON FILM RES.	RD16TPJ474	470K	470K	1/6W
R 8321	J07225474	CARBON FILM RES.	RD16TPJ474	470K	470K	1/6W
R 8322	J07225222	CARBON FILM RES.	RD16TPJ222	2.2K	2.2K	1/6W
R 8323	J07225222	CARBON FILM RES.	RD16TPJ222	2.2K	2.2K	1/6W
R 8324	J07225222	CARBON FILM RES.	RD16TPJ222	2.2K	2.2K	1/6W
R 8325	J07225335	CARBON FILM RES.	RD16TPJ335	3.3M	3.3M	1/6W
R 8326	J07225103	CARBON FILM RES.	RD16TPJ103	10K	10K	1/6W
R 8327	J07225104	CARBON FILM RES.	RD16TPJ104	100K	100K	1/6W
R 8328	J07225103	CARBON FILM RES.	RD16TPJ103	10K	10K	1/6W
R 8329	J07225103	CARBON FILM RES.	RD16TPJ103	10K	10K	1/6W
R 8330	J07225222	CARBON FILM RES.	RD16TPJ222	2.2K	2.2K	1/6W
R 8331	J07225472	CARBON FILM RES.	RD16TPJ472	4.7K	4.7K	1/6W
R 8332	J07225103	CARBON FILM RES.	RD16TPJ103	10K	10K	1/6W
R 8333	J07225334	CARBON FILM RES.	RD16TPJ334	330K	330K	1/6W
R 8334	J07225103	CARBON FILM RES.	RD16TPJ103	10K	10K	1/6W
R 8335	J07225103	CARBON FILM RES.	RD16TPJ103	10K	10K	1/6W
R 8336	J07225103	CARBON FILM RES.	RD16TPJ103	10K	10K	1/6W
R 8337	J07225151	CARBON FILM RES.	RD16TPJ151	150	150	1/6W
R 8338	J07225681	CARBON FILM RES.	RD16TPJ681	680	680	1/6W
R 8339	J07225271	CARBON FILM RES.	RD16TPJ271	270	270	1/6W
R 8340	J07225331	CARBON FILM RES.	RD16TPJ331	330	330	1/6W
R 8341	J07225100	CARBON FILM RES.	RD16TPJ100	10	10	1/6W
S 8301	N6090071	SLIDE SWITCH	SSS91			
S 8302	N6090066	SLIDE SWITCH	SS912L4NS			
S 8303	N6090066	SLIDE SWITCH	SS912L4NS			
S 8304	N7090026	DIP SWITCH SCS-06A	SCS-06A R66-3342			
S 8305	N7090026	DIP SWITCH SCS-06A	SCS-06A R66-3342			

For Service Manuals Contact
MAURITRON TECHNICAL SERVICES
 8 Cherry Tree Rd, Chinnor
 Oxon OX9 4QY
 Tel: 01844-351694 Fax: 01844-352554
 Email: enquiries@mauritron.co.uk

Switch(SW) A Unit Parts List

ADD	CODE NO	DESCRIPTION	DEVICE	TYP	VAL
S 8306	N7090012	DIP SWITCH SCS-04A	SCS-04A R66-3245		
VR8301	J60800159	POT.	RK09K1130 10KB		10KB
VR8302	J60800159	POT.	RK09K1130 10KB		10KB
VR8303	J60800159	POT.	RK09K1130 10KB		10KB
VR8304	J60800160	POT.	RK09K1130 500KB		500KB
VR8305	J51745103	POT.	H0651A013-10KB		10KB
VR8306	J51745103	POT.	H0651A013-10KB		10KB

For Service Manuals Contact
MAURITRON TECHNICAL SERVICES
8 Cherry Tree Rd, Chinnor
Oxon OX9 4QY
Tel: 01844-351694 Fax: 01844-352554
Email: enquiries@mauritron.co.uk

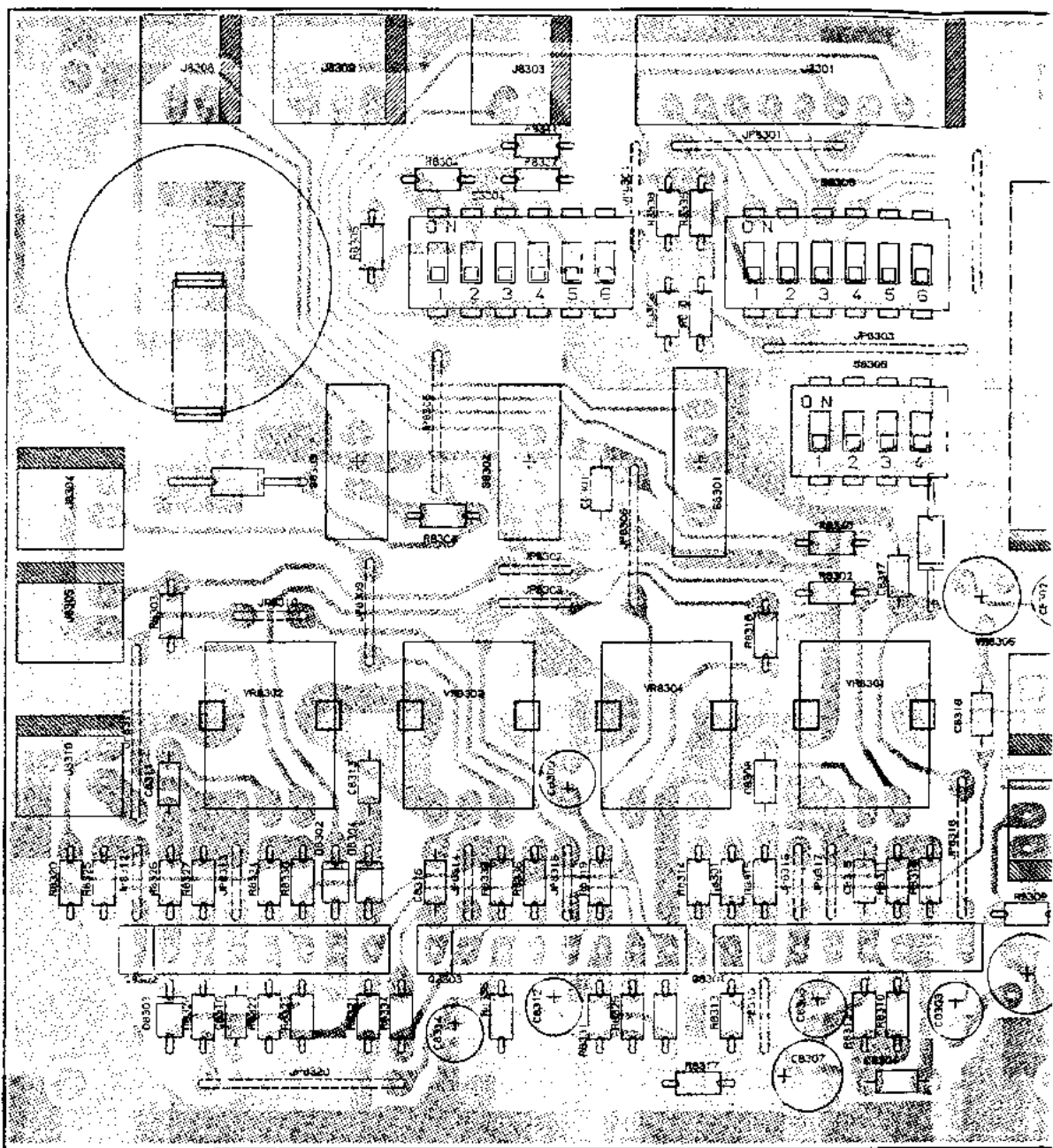

(obverse view of "component" side)

For Service Manuals Contact
MAURITRON TECHNICAL SERVICES
8 Cherry Tree Rd, Chinnor
Oxon OX9 4QY
Tel: 01844-351615 0144-352554
Email: enquiries@mauritron.co.uk

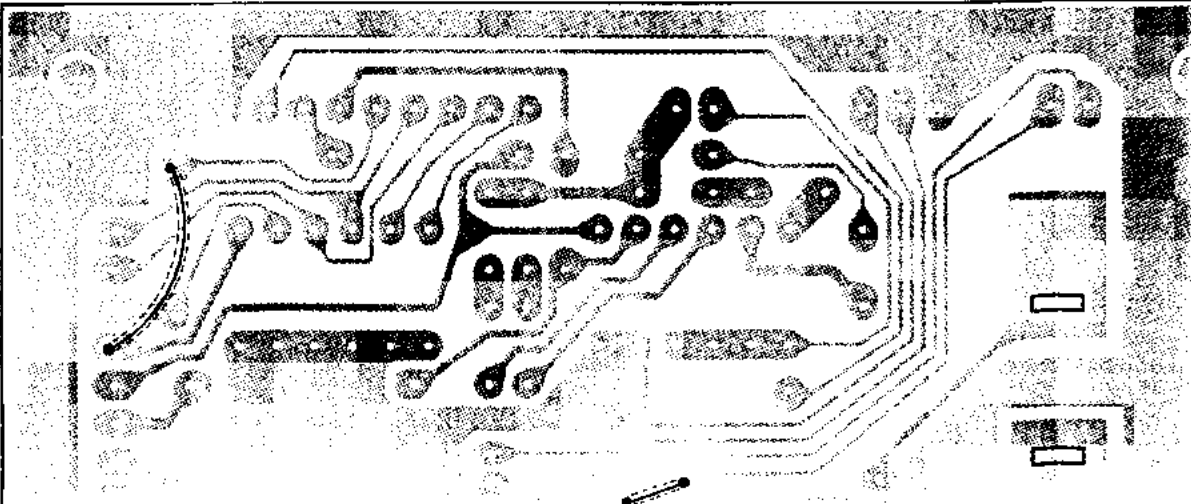

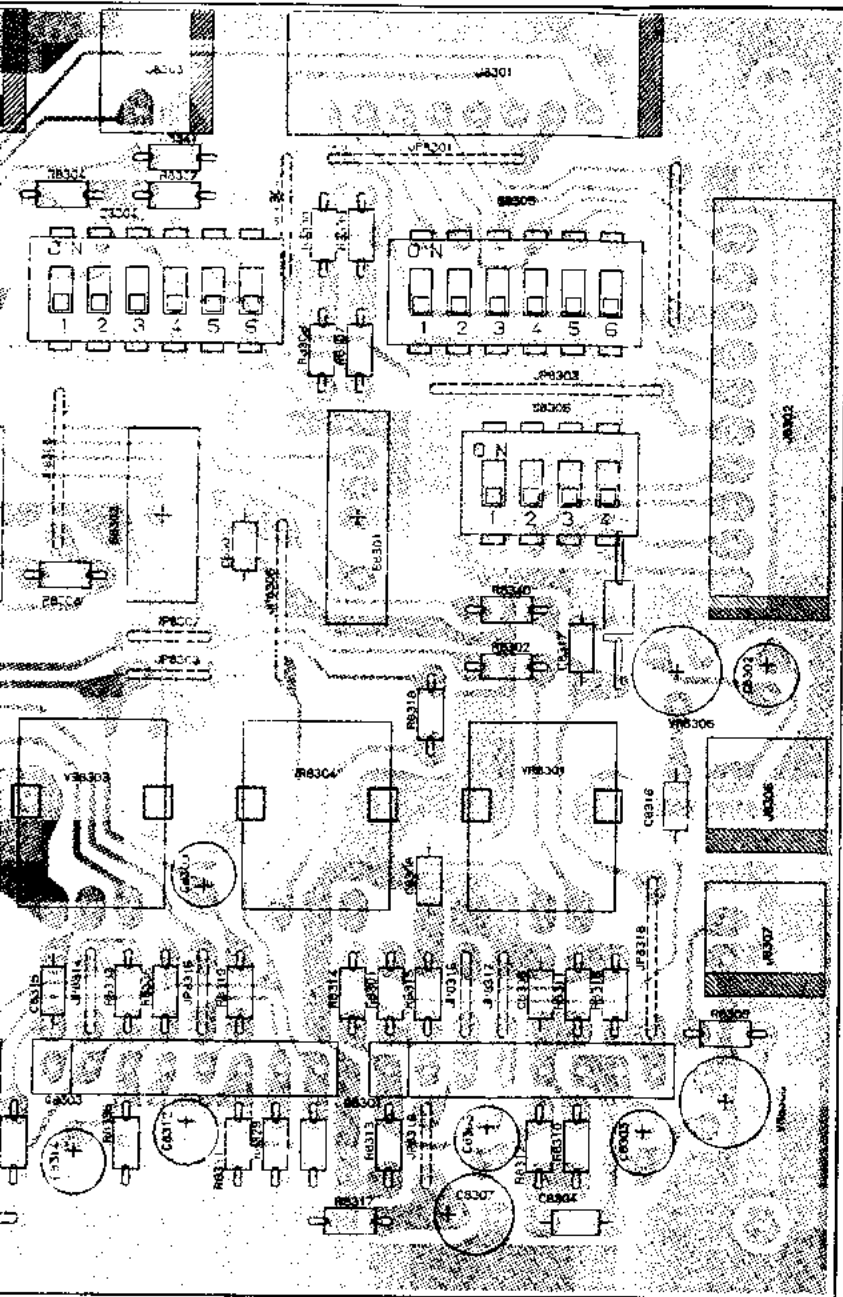

(obverse view of "component" side)

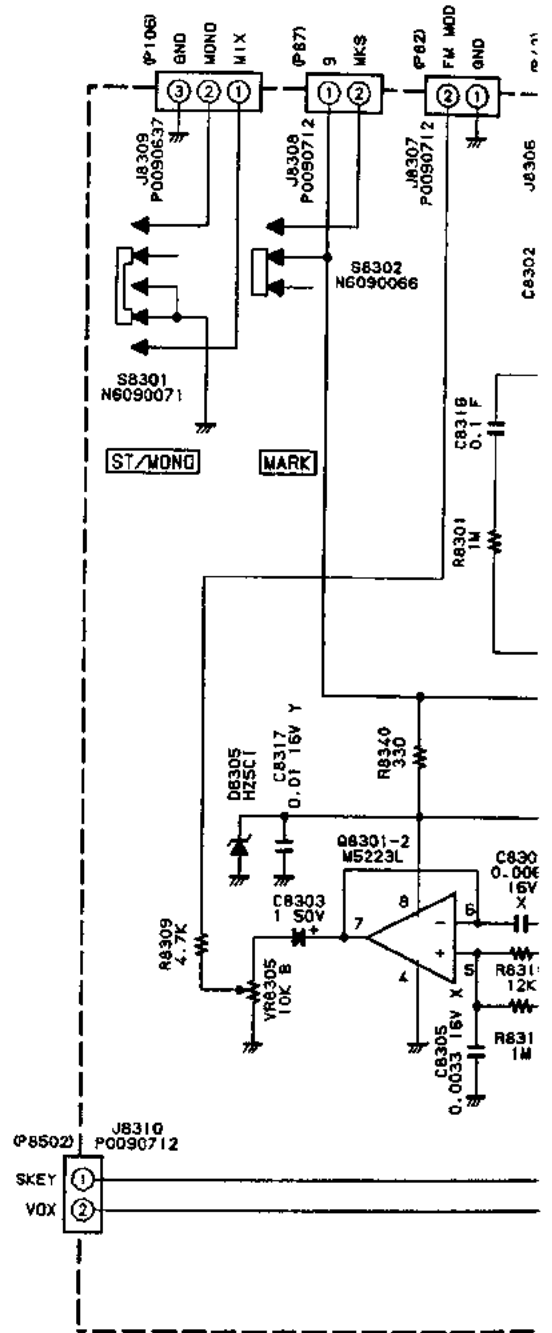
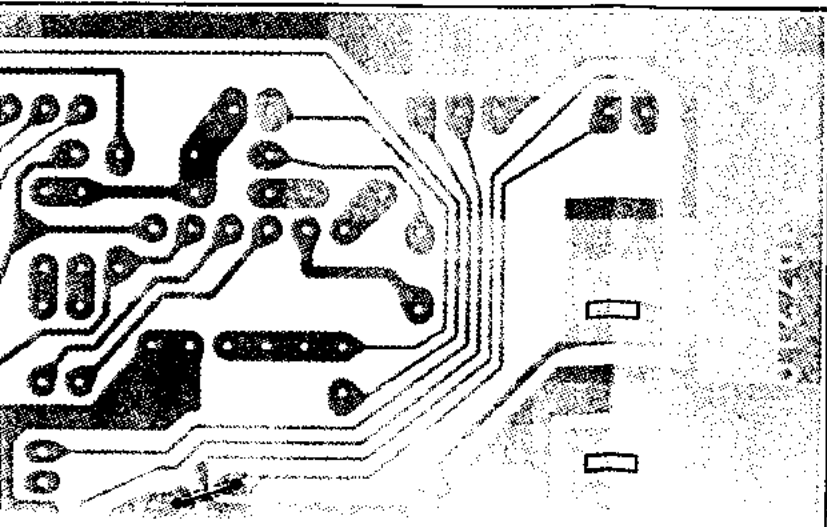

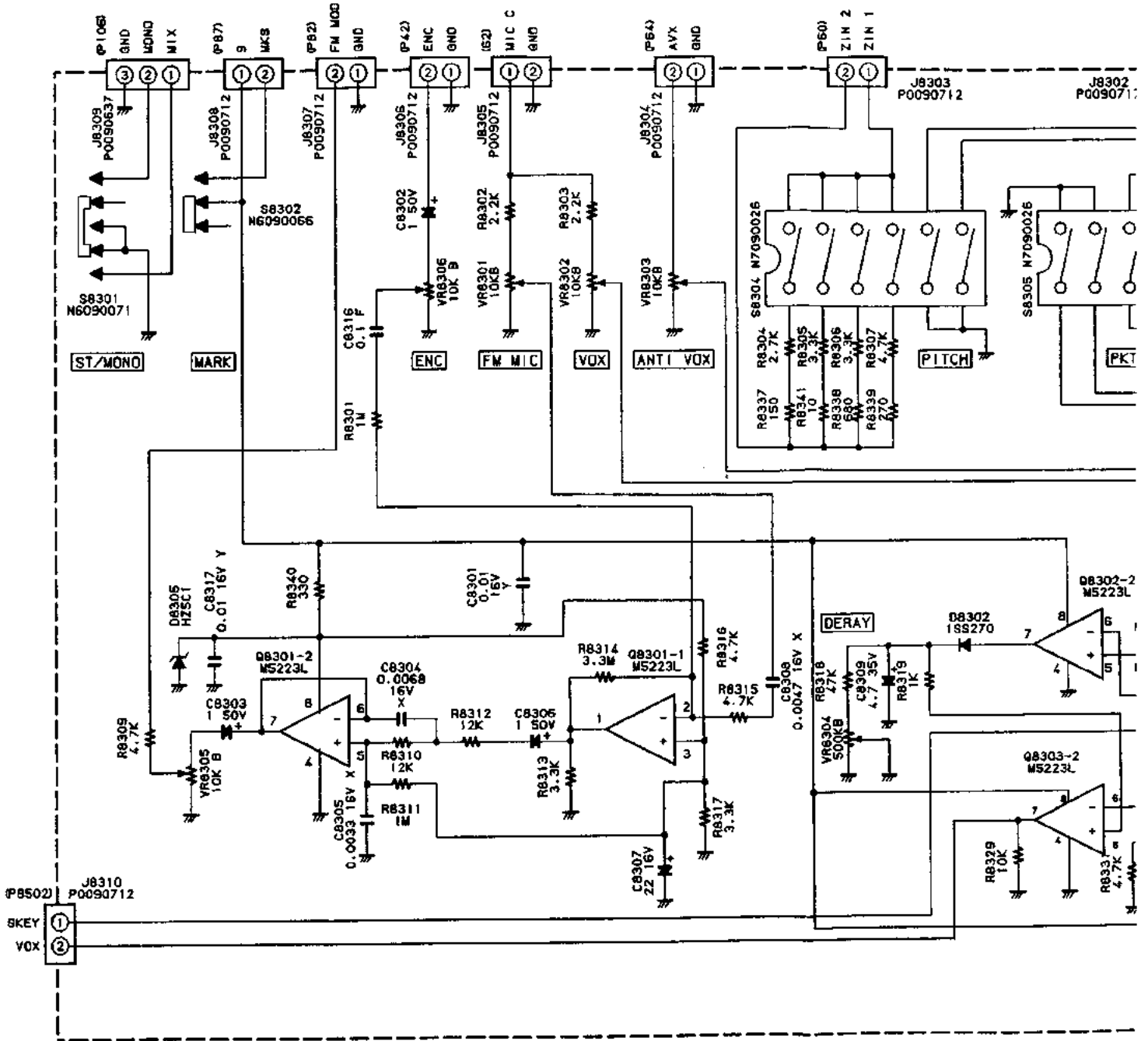

NOTE:
 RESISTOR VALUES ARE IN Ω / ΩW ;
 CAPACITOR VALUES ARE IN nF . 50V ;
 UNLESS OTHERWISE NOTED.

For Service Manuals Contact
MAURITRON TECHNICAL SERVICES
 8 Cherry Tree Rd, Chinnor
 Oxon OX9 4QY
 Tel: 01844-351694 Fax: 01844-352564
 Email: enquires@mauritron.co.uk

Switch A Unit Layout & Schematic

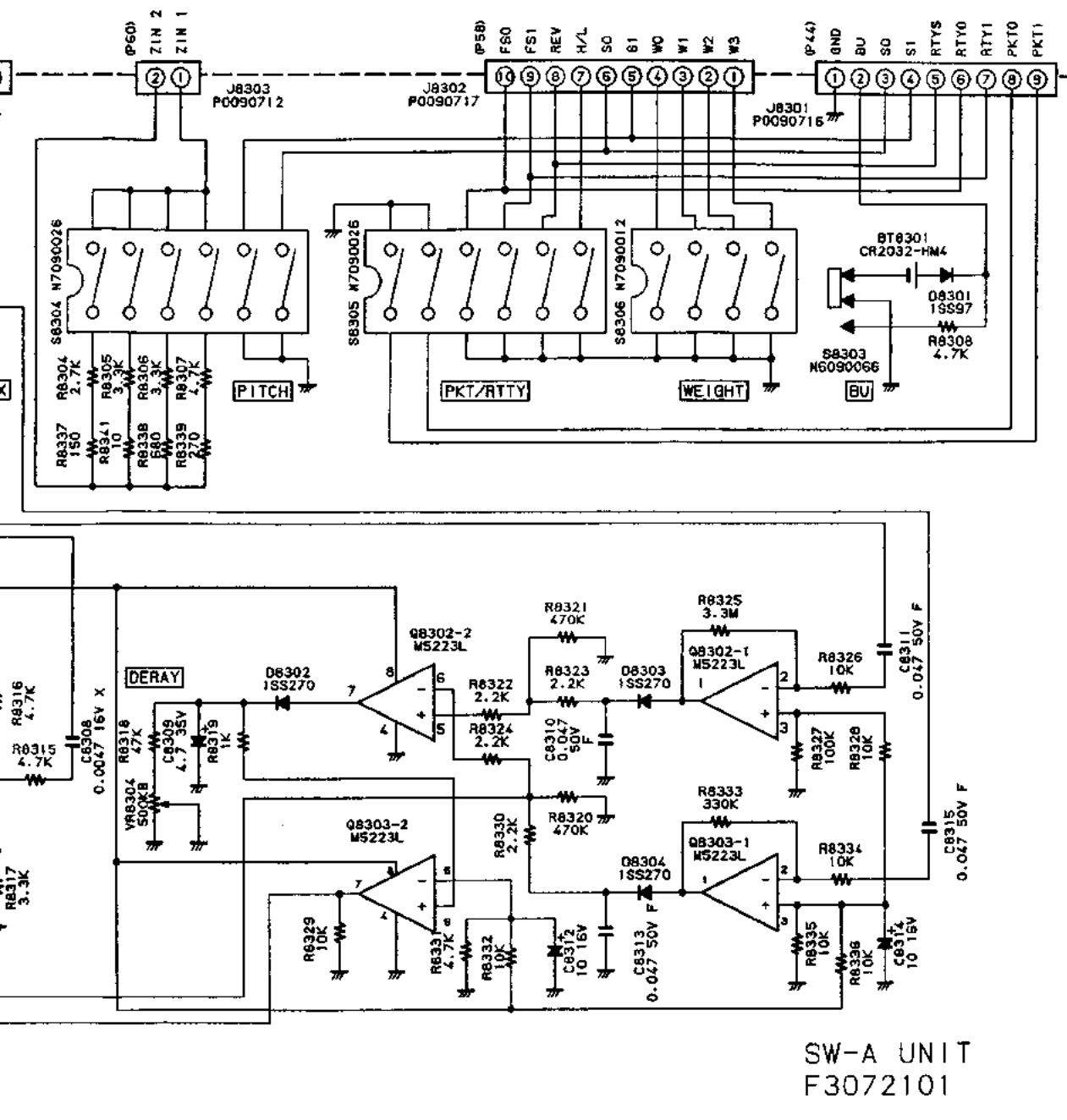

(schematic diagram)

0.1/5W ;
0.50V ;

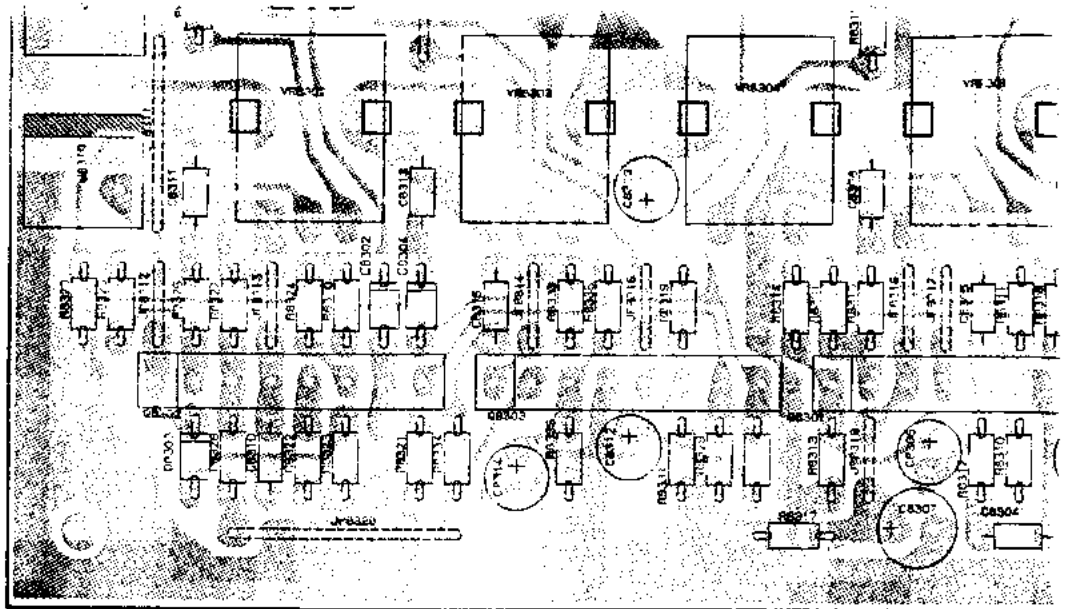

(obverse view of "compo

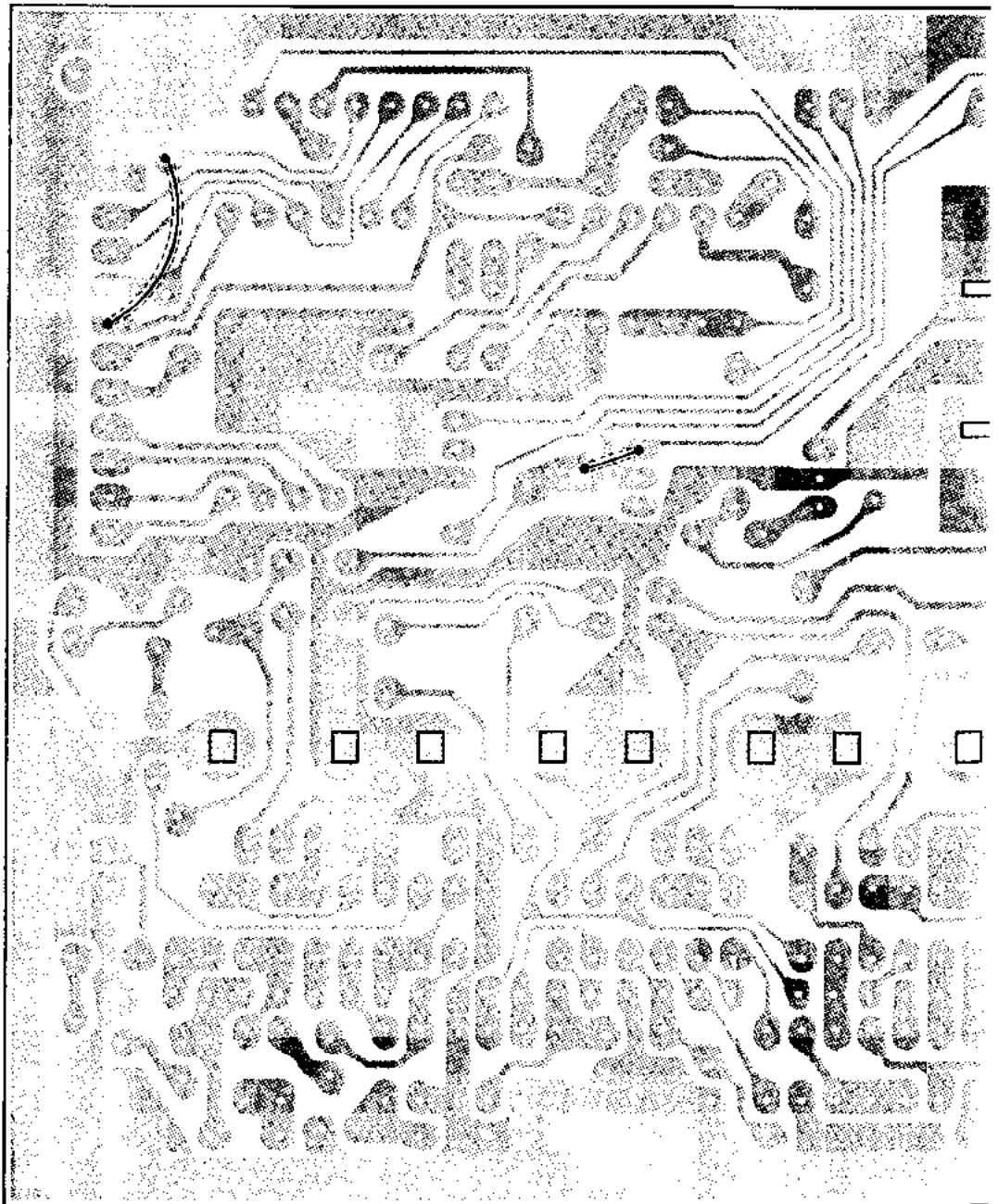

(obverse view of "chip-

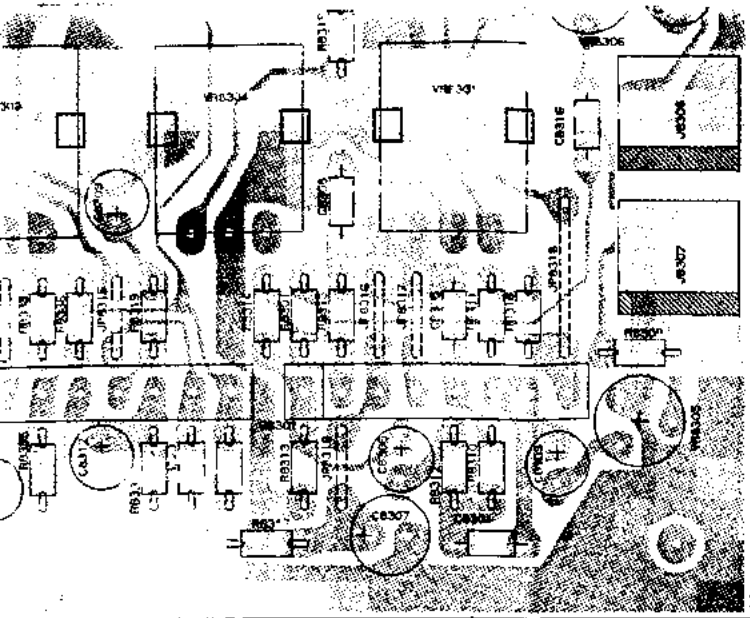

(obverse view of "component" side)

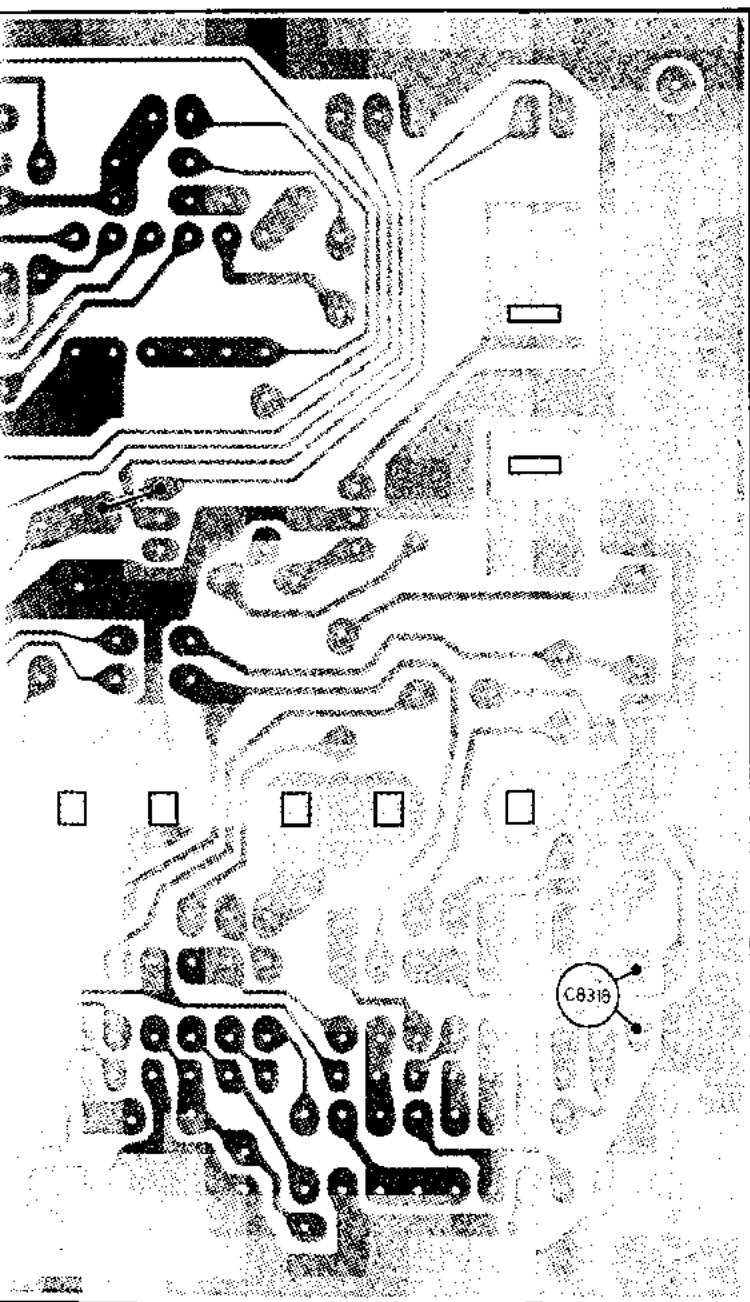

(obverse view of "chip-only" side)

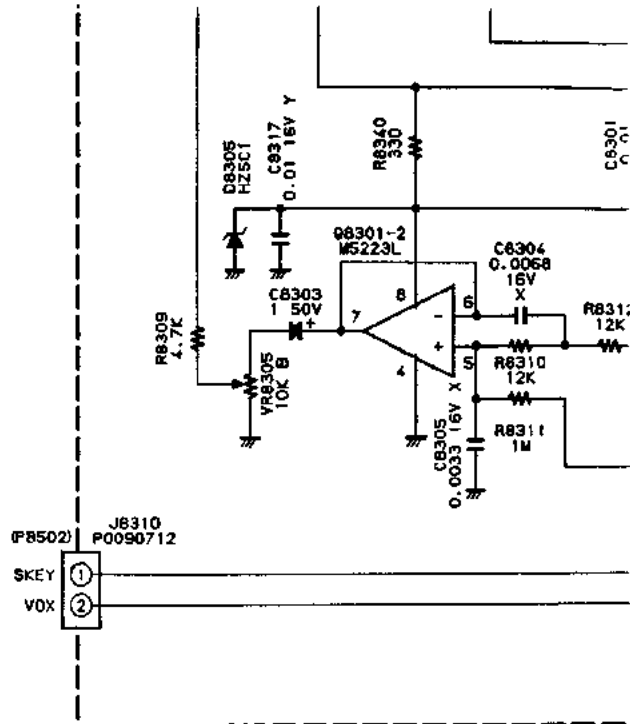

For Service Manuals Contact
MAURITRON TECHNICAL SERVICES
 8 Cherry Tree Rd, Chinnor
 Oxon OX9 4DY
 Tel: 01844-351894 Fax: 01844-352554
 Email: enquiries@maurtron.co.uk

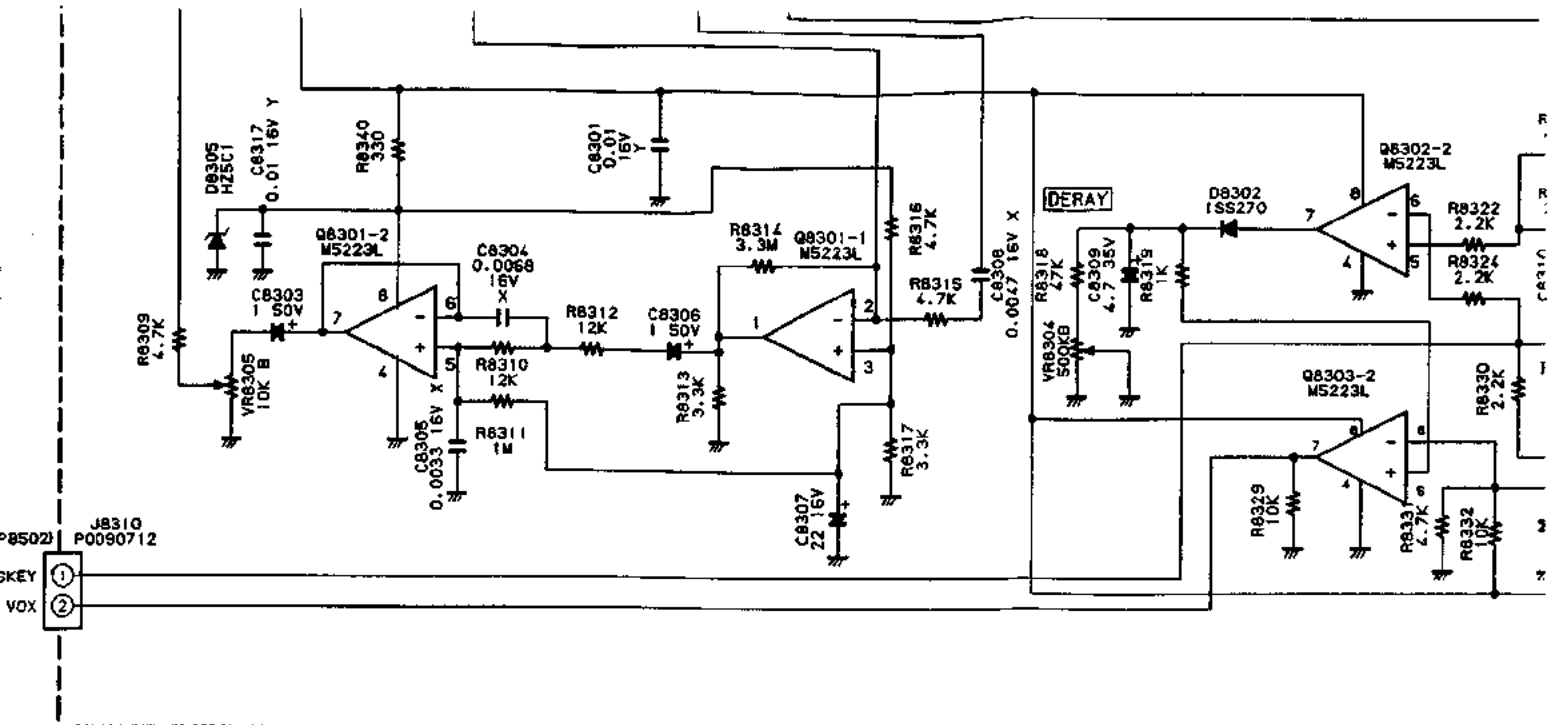

NOTE:
 RESISTOR VALUES ARE IN Ω , $k\Omega$, $M\Omega$;
 CAPACITOR VALUES ARE IN μF , 50V ;
 UNLESS OTHERWISE NOTED.

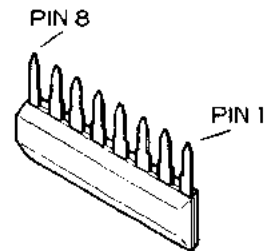

M5223L
 (Q8301, Q8302, Q8303)

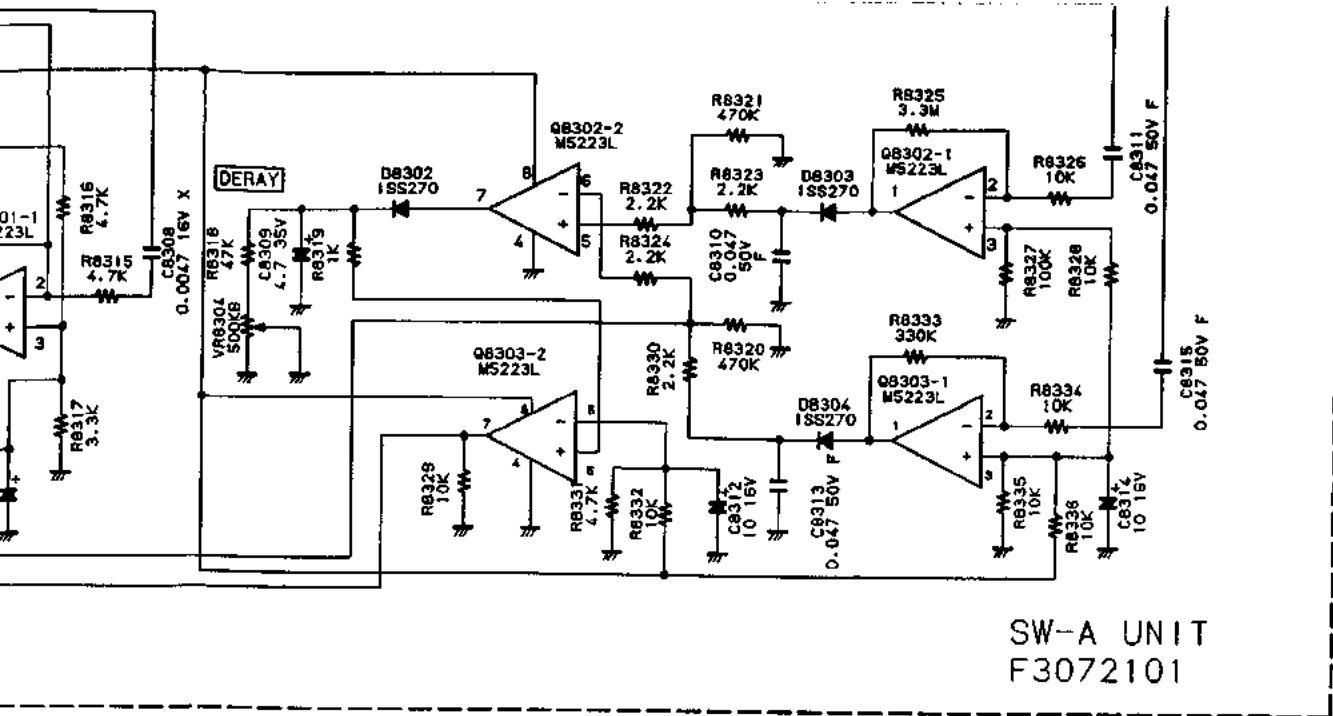

SW-A UNIT
F3072101

(schematic diagram)

RESISTOR VALUES IN OHMS UNLESS SPECIFIED OTHERWISE;
RESISTOR VALUES IN KΩ UNLESS SPECIFIED OTHERWISE;
RESISTOR VALUES IN MΩ UNLESS SPECIFIED OTHERWISE.

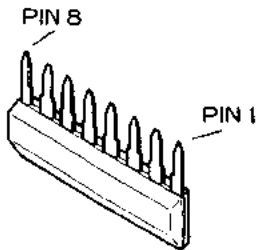

M5223L
(Q8301, Q8302, Q8303)

For Service Manuals Contact
MAURITRON TECHNICAL SERVICES
8 Cherry Tree Rd, Chinnor
Oxon OX9 4QY
Tel:- 01844-351694 Fax:- 01844-352554
Email:- enquiries@mauritron.co.uk

Switch B & C Units Parts Lists

ADD	CODE NO	DESCRIPTION	DEVICE	TYP	VAL
SW-B UNIT					
D 8401	G2090408	DIODE	1SS270		
D 8402	G2090408	DIODE	1SS270		
D 8403	G2090408	DIODE	1SS270		
D 8404	G2090408	DIODE	1SS270		
JP8401	T9205872	WIRE-ASSY 2710			
JP8402	T9205873	WIRE-ASSY 2710			
JP8403	T9205874	WIRE-ASSY 2710			
JP8404	T9205875	WIRE-ASSY 2710			
JP8405	T9205876	WIRE-ASSY 2710			
JP8406	Q6100015	JUMPER WIRE			
JP8407	Q6100015	JUMPER WIRE			
Q 8401	G3090079	TRANSISTOR	BA1A4P		
S 8401	N0190149	ROTARY SWITCH	SRBU15		
S 8402	N0190148	ROTARY SWITCH	SRBU14		
S 8403	N0190150	ROTARY SWITCH	SRBU16		
VR8401	J62800105	POT.	RK12 10KB/10KB		

SW-C UNIT

D 8501	G2050011	LED	LT3N44D		
D 8502	G2050011	LED	LT3N44D		
J 8501	P0090622	CONNECTOR			
JP8501	T9205877	WIRE-ASSY 2710			
JP8502	T9205878	WIRE-ASSY 2710			
JP8503	T9205879	WIRE-ASSY 2710			
JP8504	T9205880	WIRE-ASSY 2710			
Q 8501	G3090079	TRANSISTOR	BA1A4P		
R 8501	J02225102	CARBON FILM RES.	RD16UJ102	1K	1/6W
R 8502	J02225102	CARBON FILM RES.	RD16UJ102	1K	1/6W
S 8501	N4090086	PUSH SWITCH	SPH121A94		
S 8502	N4090086	PUSH SWITCH	SPH121A94		
S 8503	N4090086	PUSH SWITCH	SPH121A94		
S 8504	N4090086	PUSH SWITCH	SPH121A94		

For Service Manuals Contact
MAURITRON TECHNICAL SERVICES
 8 Cherry Tree Rd, Chinnor
 Oxon OX9 4QY
 Tel: 01844-351894 Fax: 01844-352554
 Email: enquiries@mauritron.co.uk

Notes

For Service Manuals Contact
MAURITRON TECHNICAL SERVICES
8 Cherry Tree Rd, Chinnor
Oxon OX9 4QY
Tel: 01844-351694 Fax: 01844-352554
Email: enquiries@mauritron.co.uk

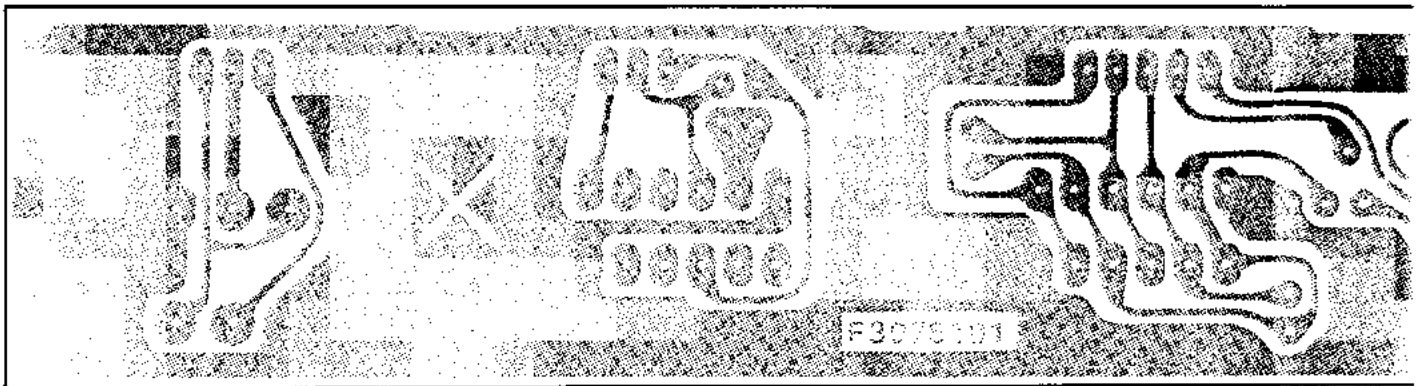
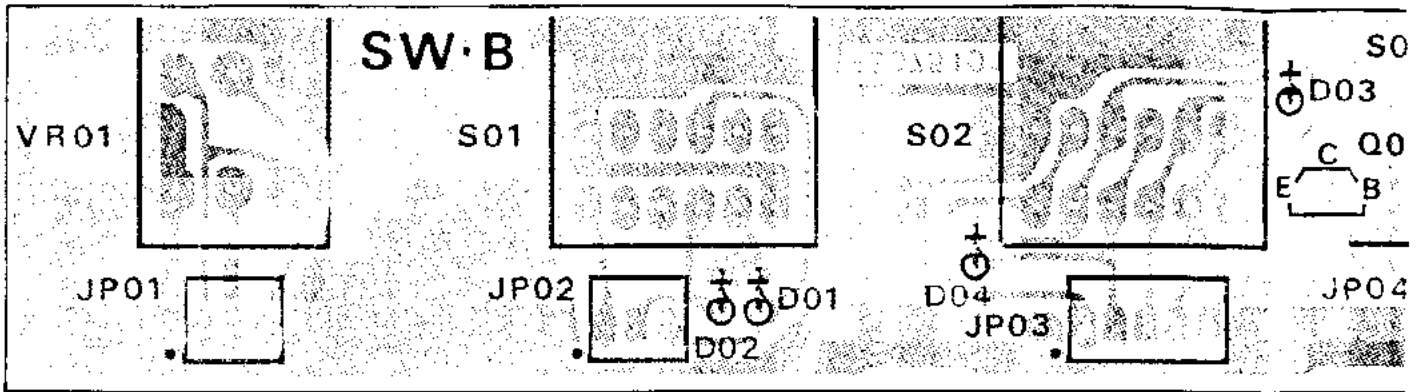

(obverse)

SW B UNIT

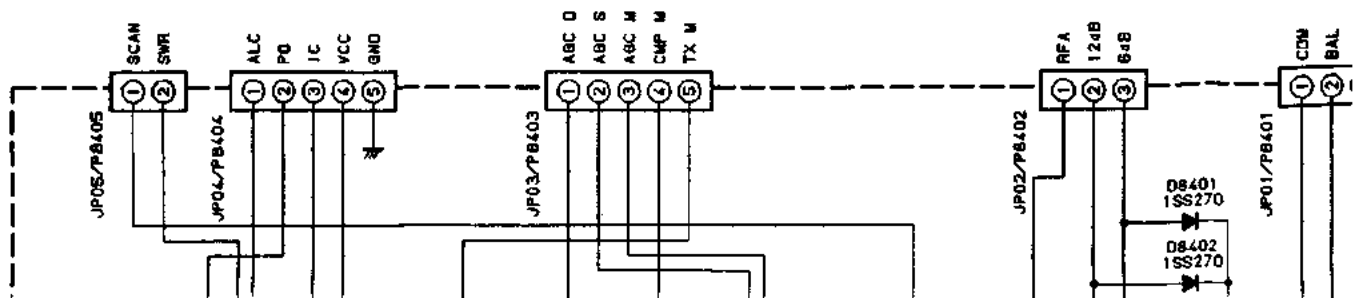

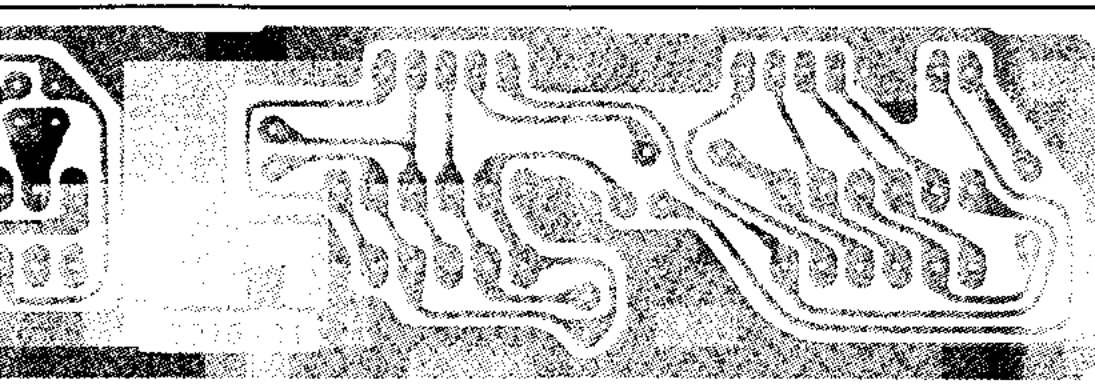
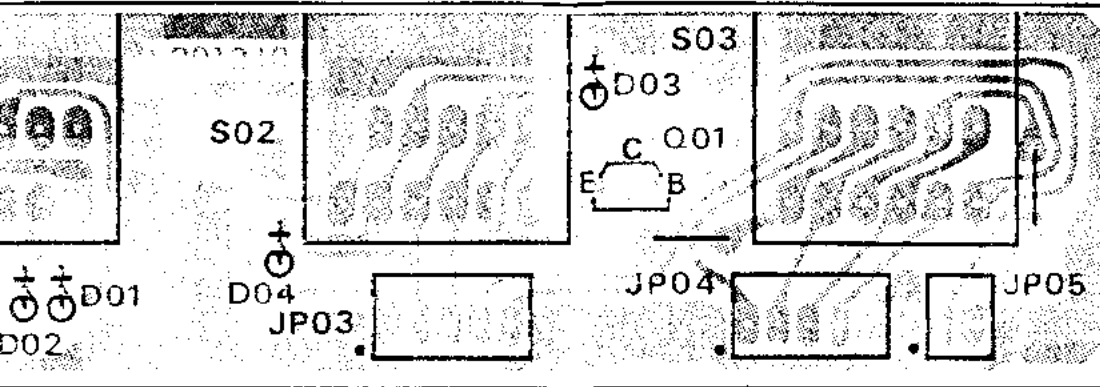

(obverse view of "solder" side)

SW B UNIT

For Service Manuals Contact
MAURITRON TECHNICAL SERVICES
 8 Cherry Tree Rd, Chinnor
 Oxon OX9 4QY
 Tel: 01844-351694 Fax: 01344-352554
 Email: enquiries@mauritron.co.uk

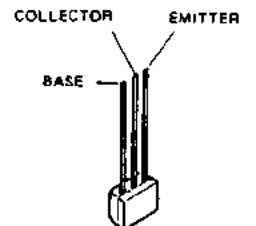

BA1A4P
 (Q8401, Q8501)

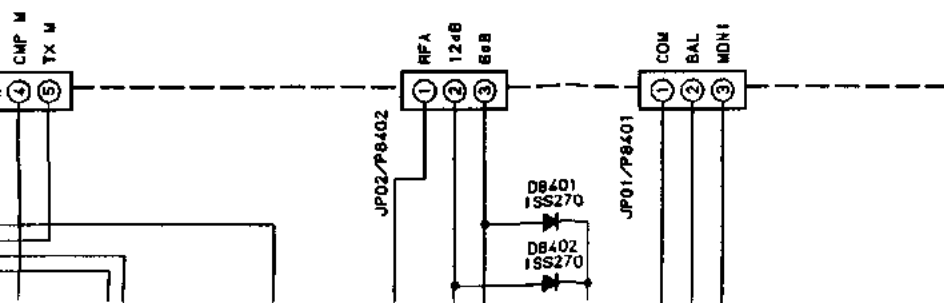

Switch B & C Units I



er" side)

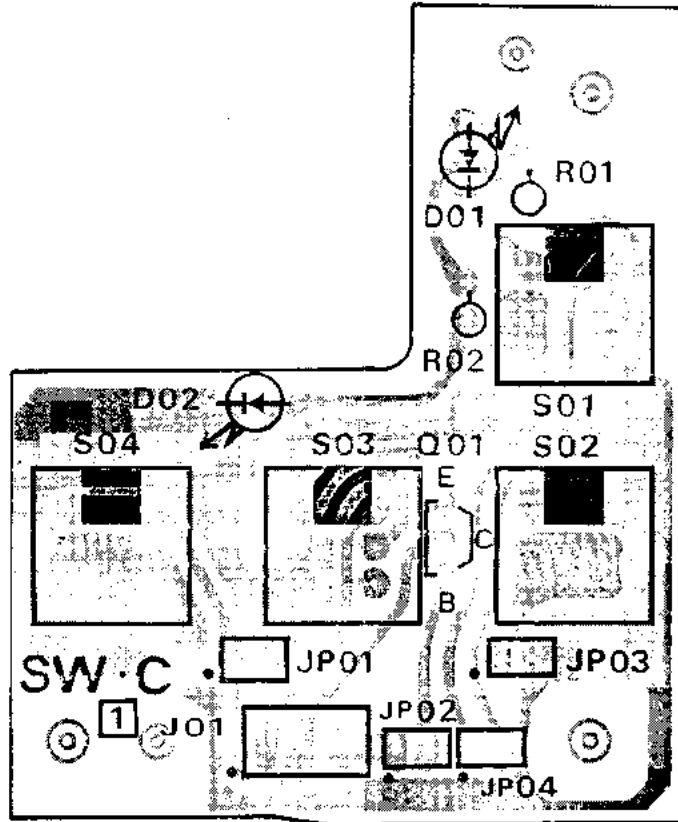

(obverse view of "component" side)

SW C UN

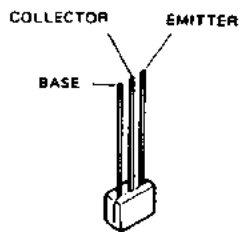

BA1A4P
(08401, 08501)

SW-C-UNIT
F3074101

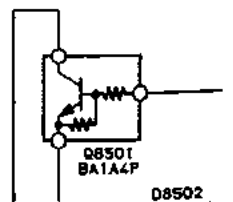

Switch B & C Units Layouts & Schematic Diagrams

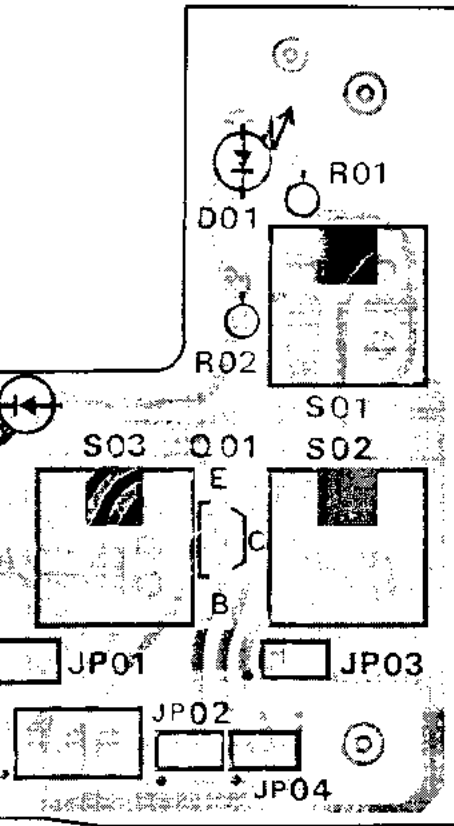

(view of "component" side)

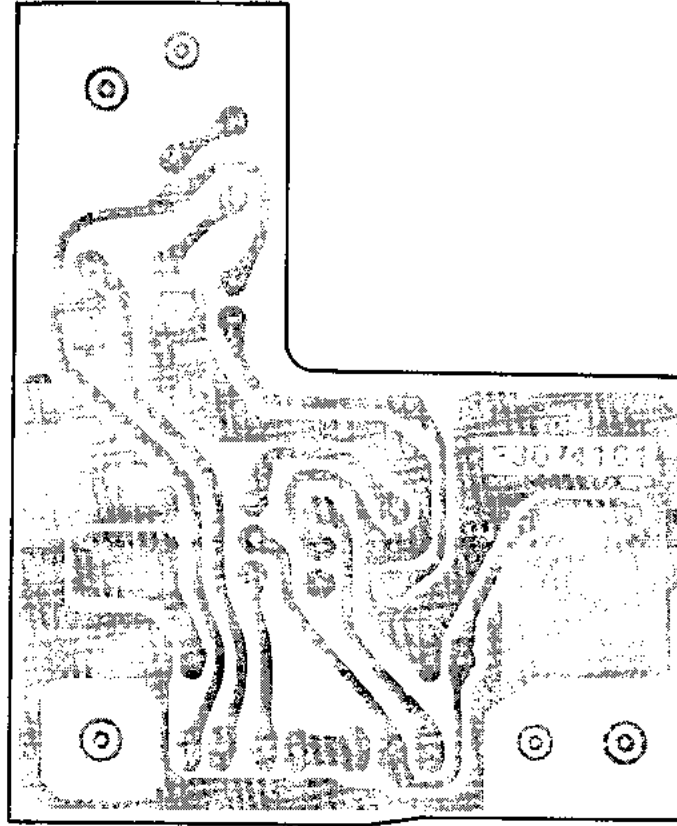

(obverse view of "solder" side)

SW C UNIT

For Service Manuals Contact
MAURITRON TECHNICAL SERVICES
 8 Cherry Tree Rd, Chinnor
 Oxon OX9 4QY
 Tel:- 01844-351694 Fax:- 01844-352554
 Email:- enquiries@mauritron.co.uk

-UNIT
 4101

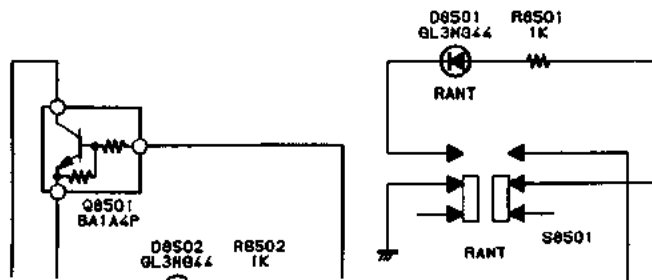

F3075101

SW B UNIT

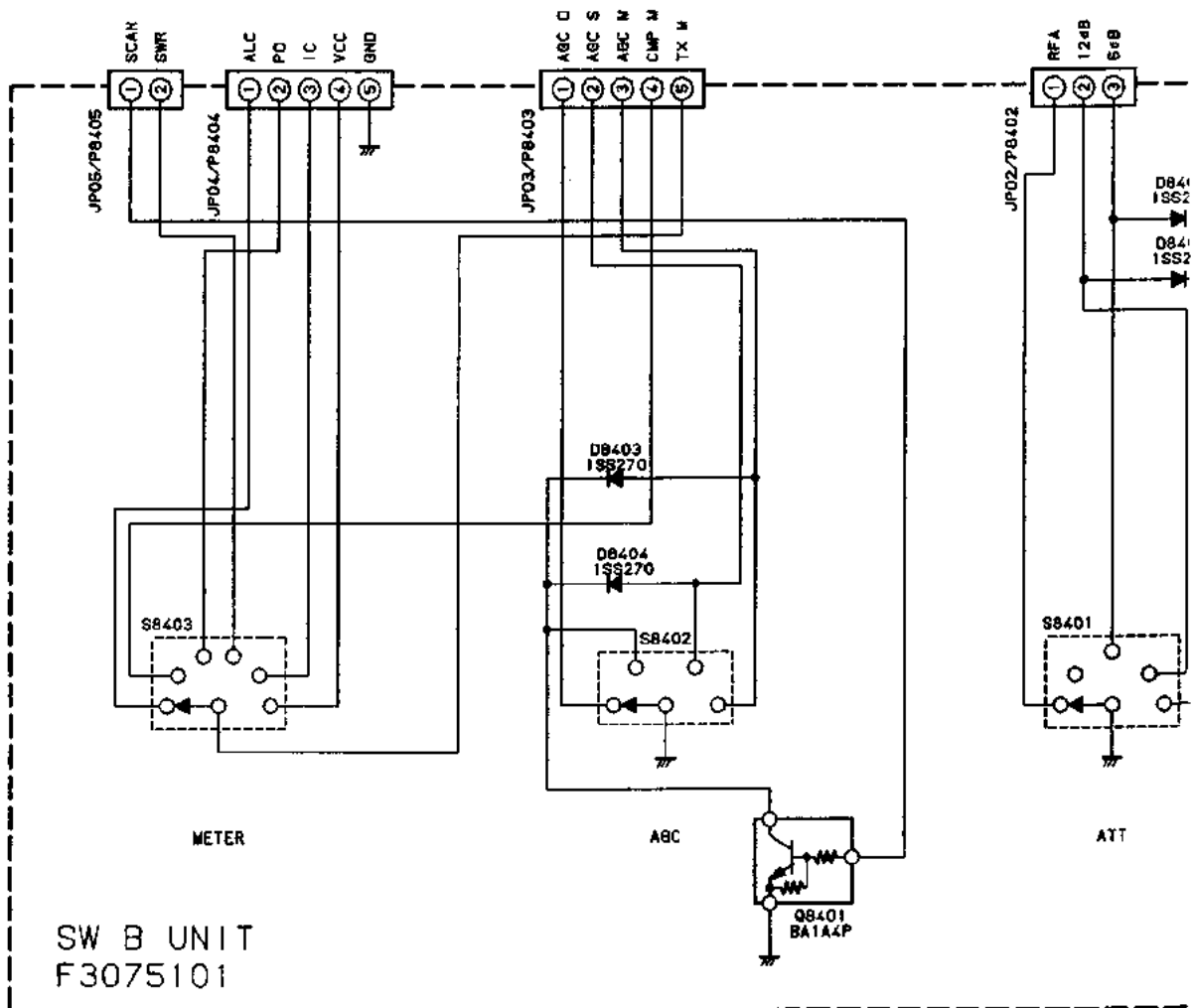

(SW B U



(obverse view of "solder" side)

SW B UNIT

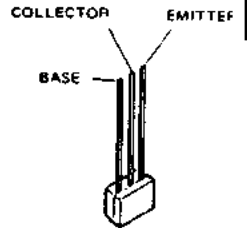

BA1A4P
(Q8401, Q8501)

For Service Manuals Contact
MAURITRON TECHNICAL SERVICES
 8 Cherry Tree Rd, Chinnor
 Oxon OX9 4QY
 Tel: 01844-351694 Fax: 01844-352554
 Email: enquiries@mauritron.co.uk

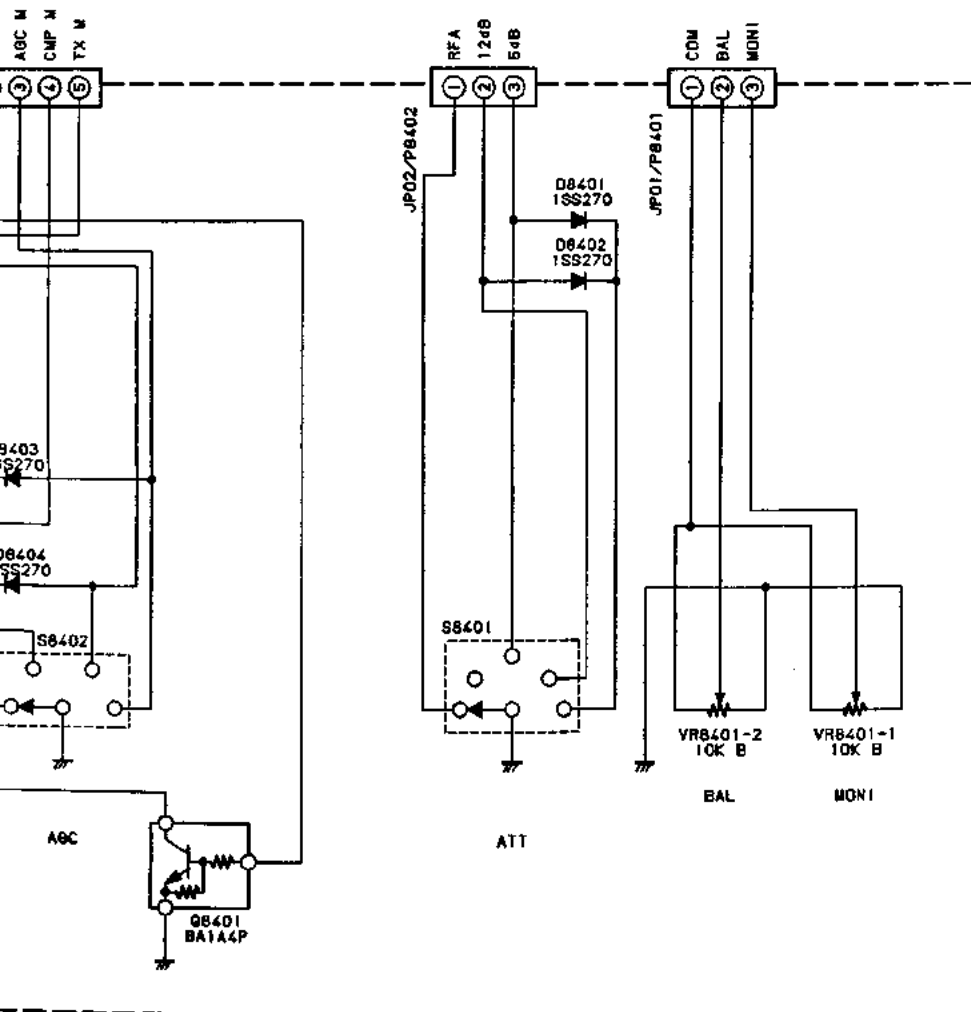

(SW B UNIT schematic diagram)

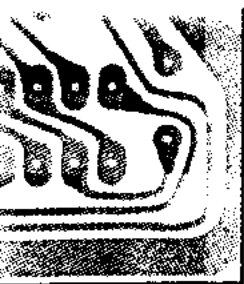

("solder" side)

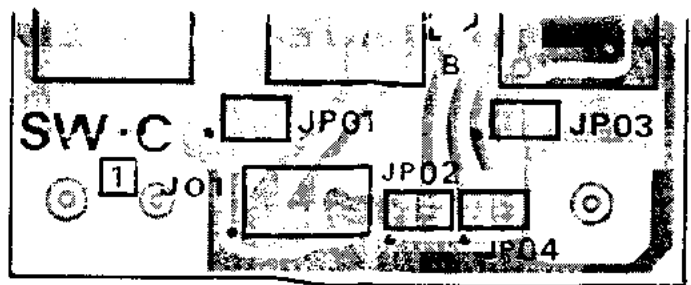

(obverse view of "component" side)

SW C

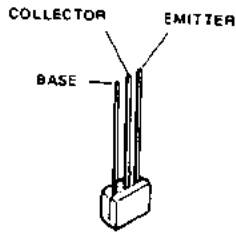

BA1A4P
(08401, 08501)

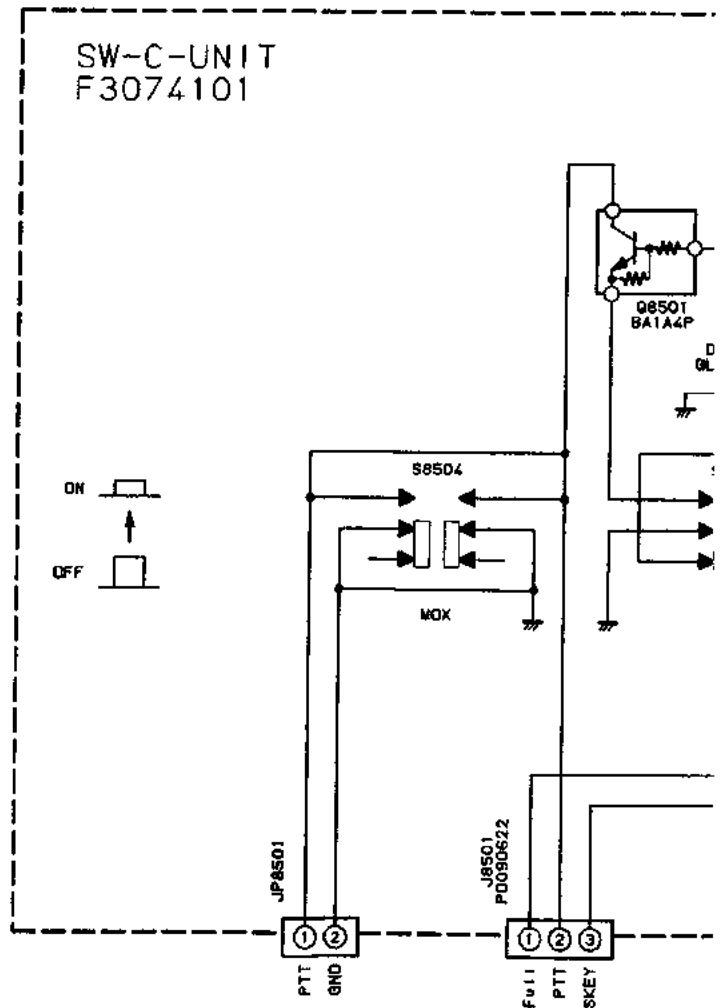

NOTE:
RESISTOR VALUES ARE IN Ω/W ;

SW B & C UNIT

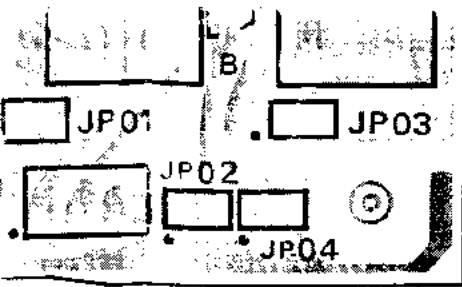

view of "component" side)

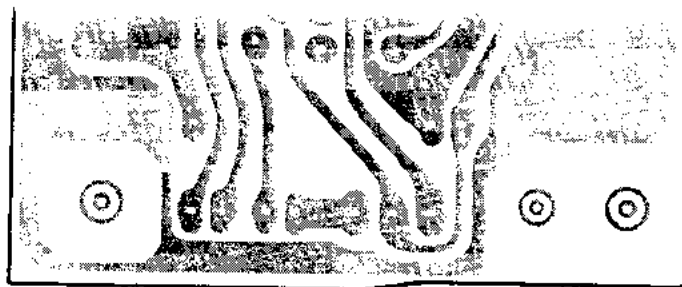

(obverse view of "solder" side)

SW C UNIT

For Service Manuals Contact
MAURITRON TECHNICAL SERVICES
 8 Cherry Tree Rd, Chinnor
 Oxon OX9 4QY
 Tel:- 01844-351634 Fax:- 01844-352554
 Email:- enquiries@mauritron.co.uk

UNIT
 4101

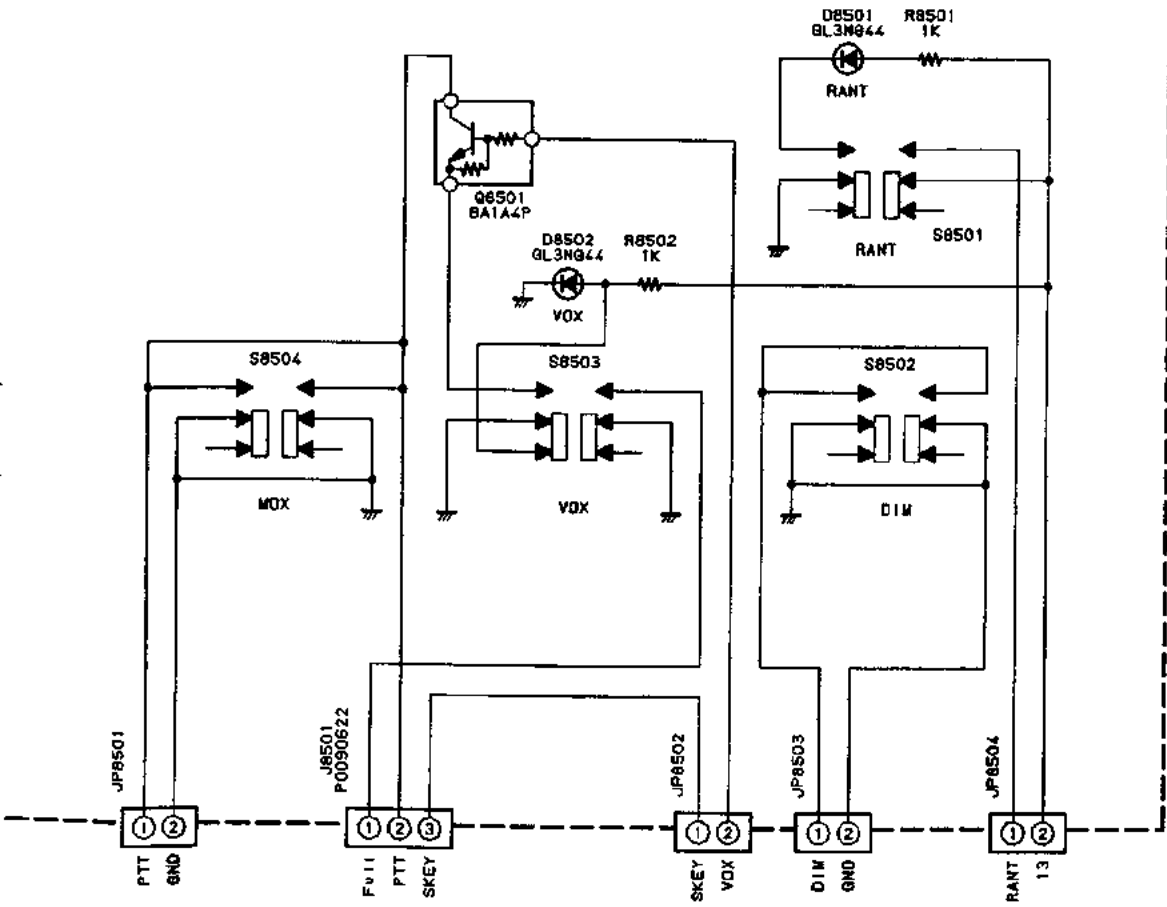

(SW C UNIT schematic diagram)

VALUES ARE IN Ω. 1/5W

Switch D, E & F Units Parts Lists

ADD	CODE NO	DESCRIPTION	DEVICE	TYP	VAL
SW-D UNIT					
D 8601	G2090461	LED	TL0221		
D 8602	G2090458	LED	TLG221		
JP8601	T9205881	WIRE-ASSY 2710			
SW-E UNIT					
JP8701	T9205882	WIRE-ASSY 2710			
JP8702	T9205883	WIRE-ASSY 2710			
JP8703	T9205884	WIRE-ASSY 2710			
S 8701	N0190147	ROTARY SWITCH	SRRS2R		
S 8702	Q9000524	ROTARY CODE SWITCH	EC16B25D		
SW-F UNIT					
D 8801	G2050011	LED	LT3N44D		
JP8801	T9205885	WIRE-ASSY 2710			
JP8802	T9205886	WIRE-ASSY 2710			
JP8803	T9205887	WIRE-ASSY 2710			
JP8804	T9205888	WIRE-ASSY 2710			
JP8805	T9205889	WIRE-ASSY 2710			
JP8806	Q6100015	JUMPER WIRE			
JP8807	Q6100015	JUMPER WIRE			
JP8808	Q6100015	JUMPER WIRE			
R 8801	J02225681	CARBON FILM RES.	RD16UJ681	680	1/6W
S 8801	N4090085	PUSH SWITCH	SPH221A		
S 8802	N4090085	PUSH SWITCH	SPH221A		
S 8803	N4090085	PUSH SWITCH	SPH221A		

Notes

For Service Manuals Contact
MAURITRON TECHNICAL SERVICES
8 Cherry Tree Rd. Chinnor
Oxon OX9 4QY
Tel:- 01844-351634 Fax:- 01844-352554
Email:- enquiries@mauritron.co.uk

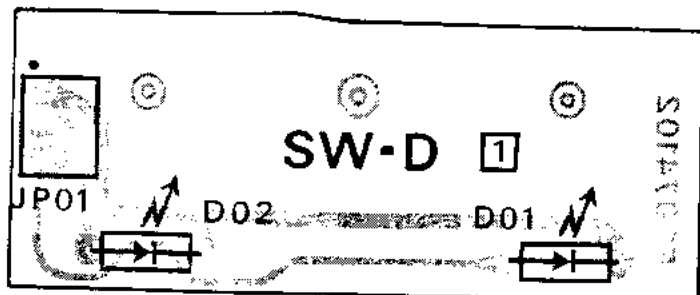

(obverse view of "component" side)

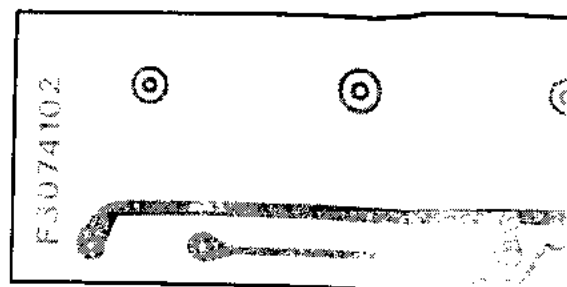

(obverse view of "solder" side)

SW D UNIT

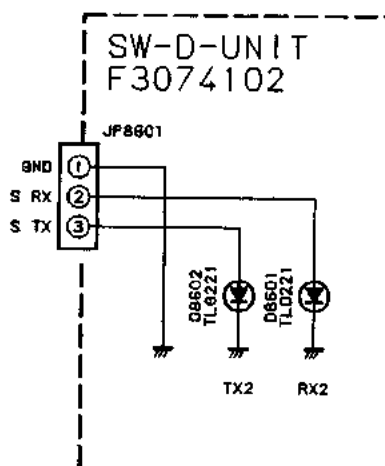

(SW D UNIT schematic diagram)

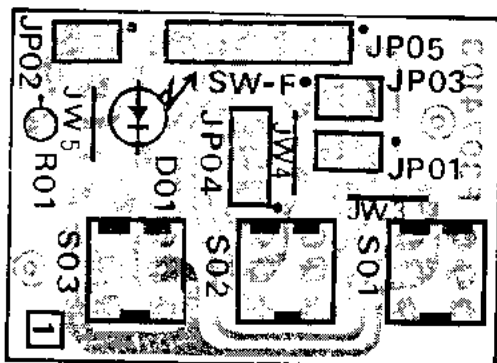

(obverse view of "component" side)

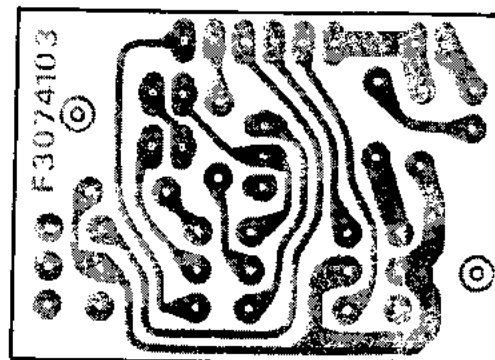

(obverse view of "solder" side)

SW F UNIT



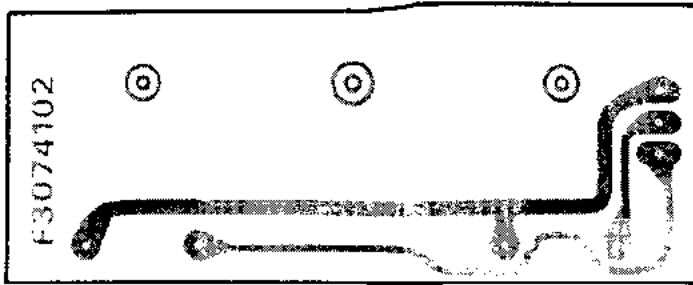

(obverse view of "solder" side)

UNIT



(schematic diagram)

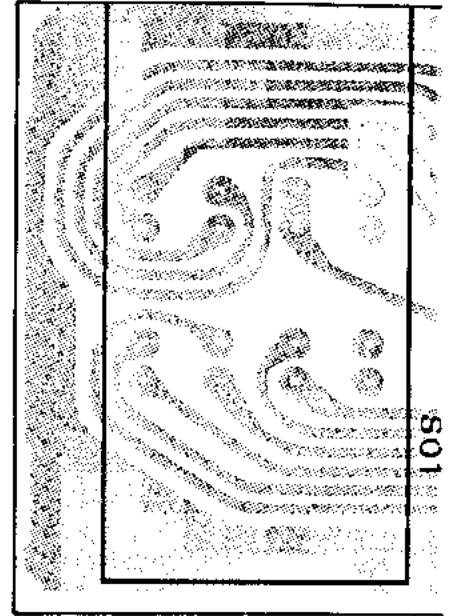

(obverse view)

For Service Manuals Contact
MAURITRON TECHNICAL SERVICES
 8 Cherry Tree Rd, Chinnor
 Oxon OX9 4QY
 Tel: 01844-351634 Fax: 01844-352554
 Email: enquiries@maurtron.co.uk

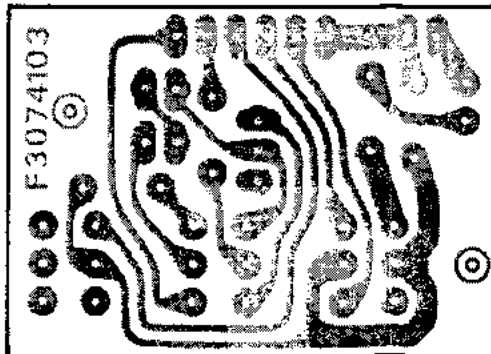

(obverse view of "solder" side)

UNIT



Switch D, E & F Units

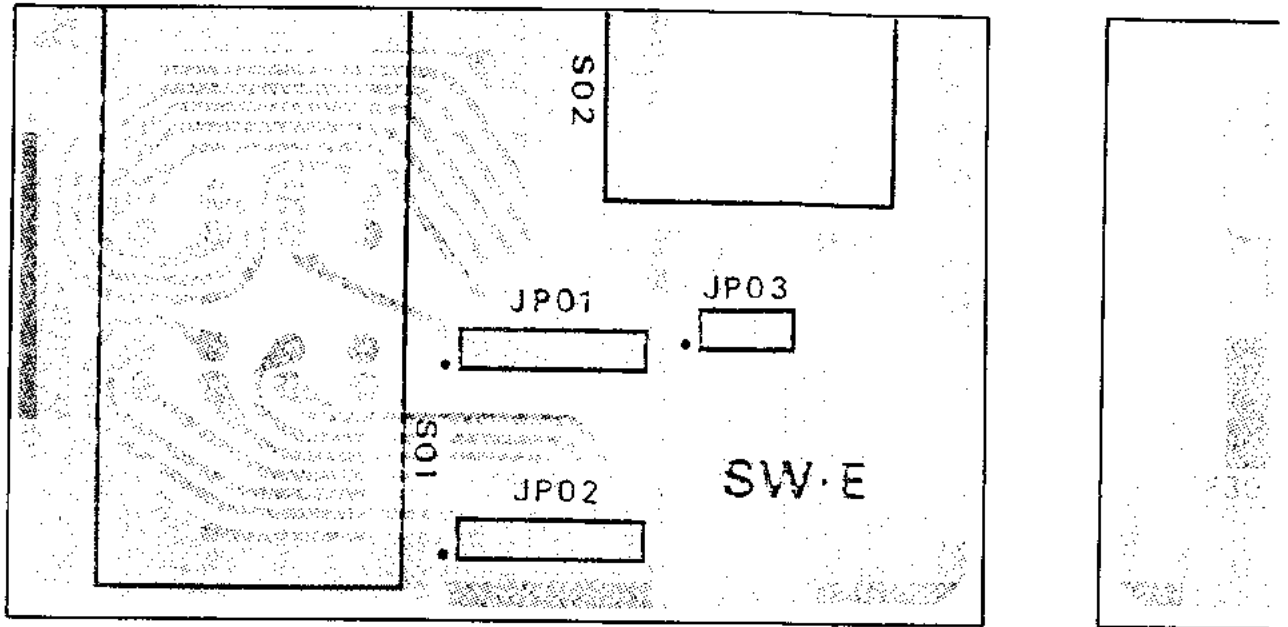

(obverse view of "component" side)

SW E UNIT

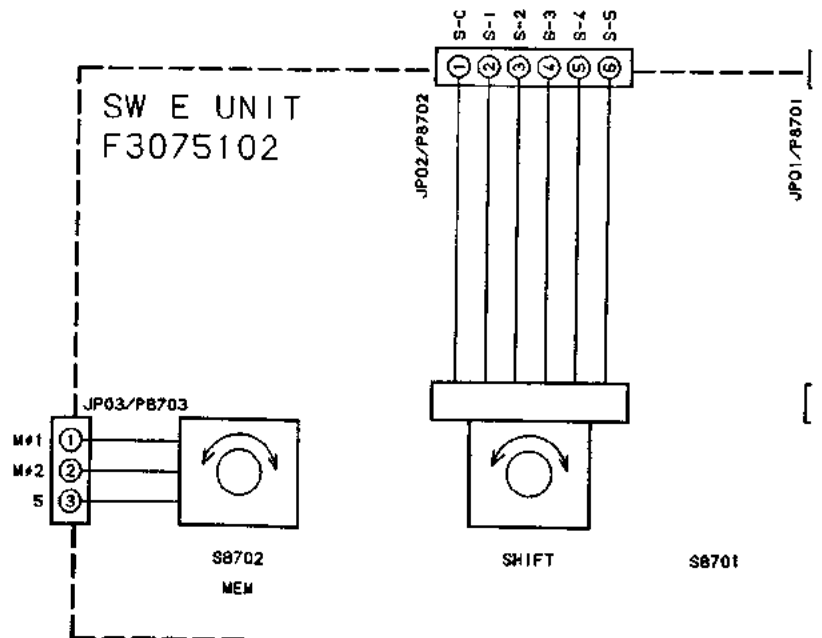

(SW E UNIT schematic diagram)

Switch D, E & F Units Layout & Schematic Diagrams

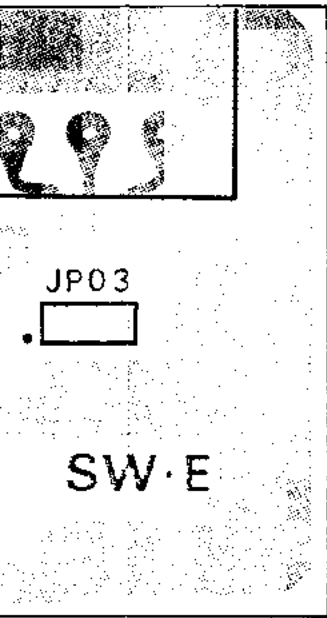

(“front” side)

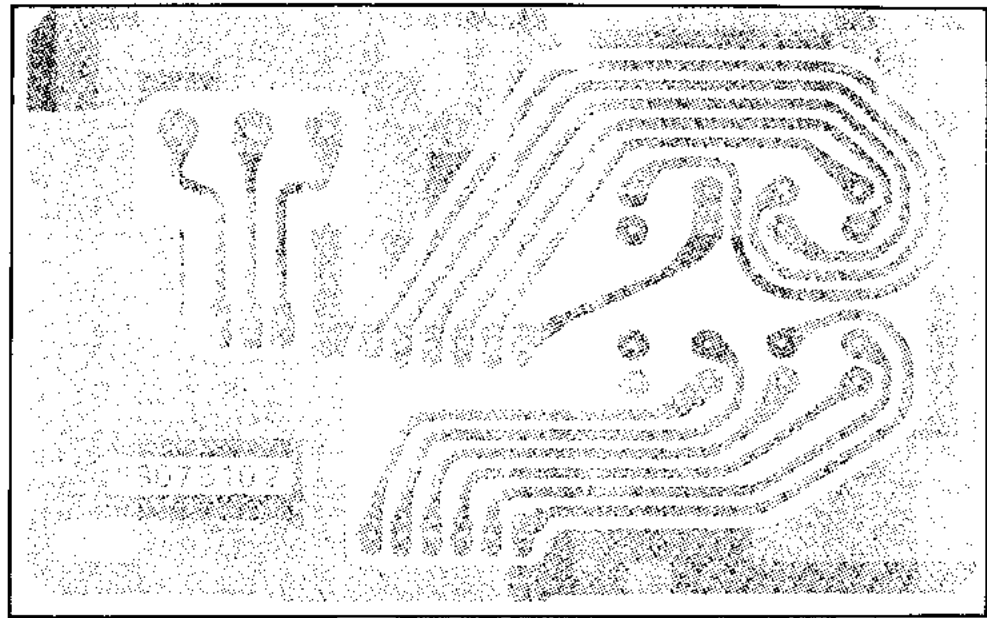

(obverse view of “solder” side)

SW E UNIT

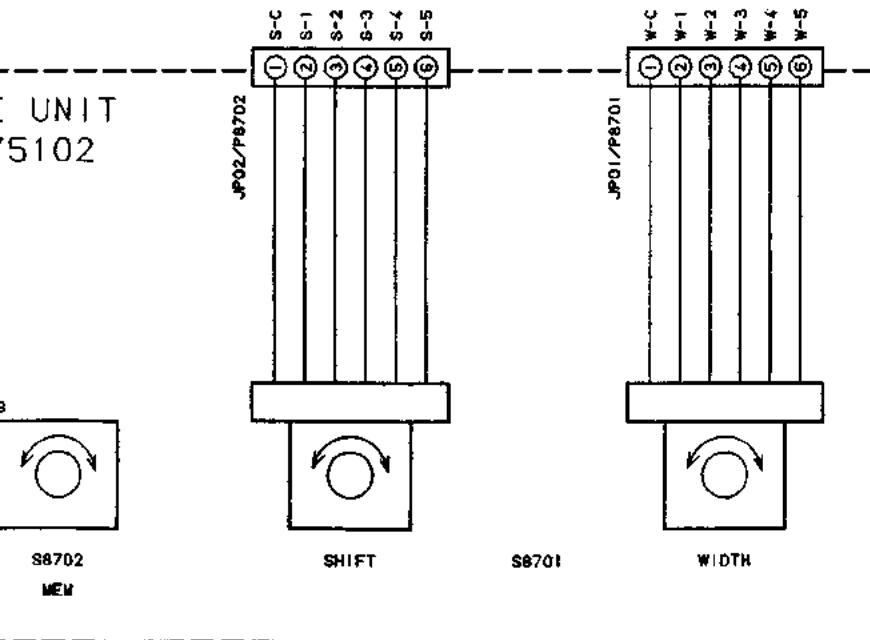

(SW E UNIT schematic diagram)

For Service Manuals Contact
MAURITRON TECHNICAL SERVICES
 B Cherry Tree Rd, Chinnor
 Oxon OX9 4QY
 Tel: 01844-351694 Fax: 01844-352554
 Email: enquiries@mauritron.co.uk

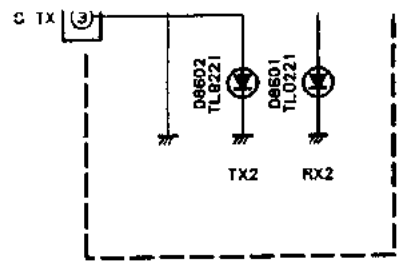

(SW D UNIT schematic diagram)

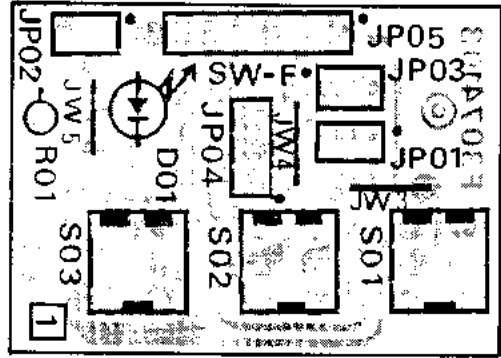

(obverse view of "component" side)

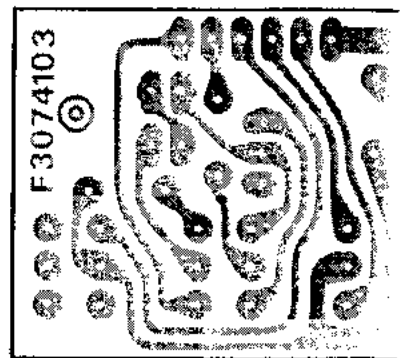

(obverse view of "solder" side)

SW F UNIT

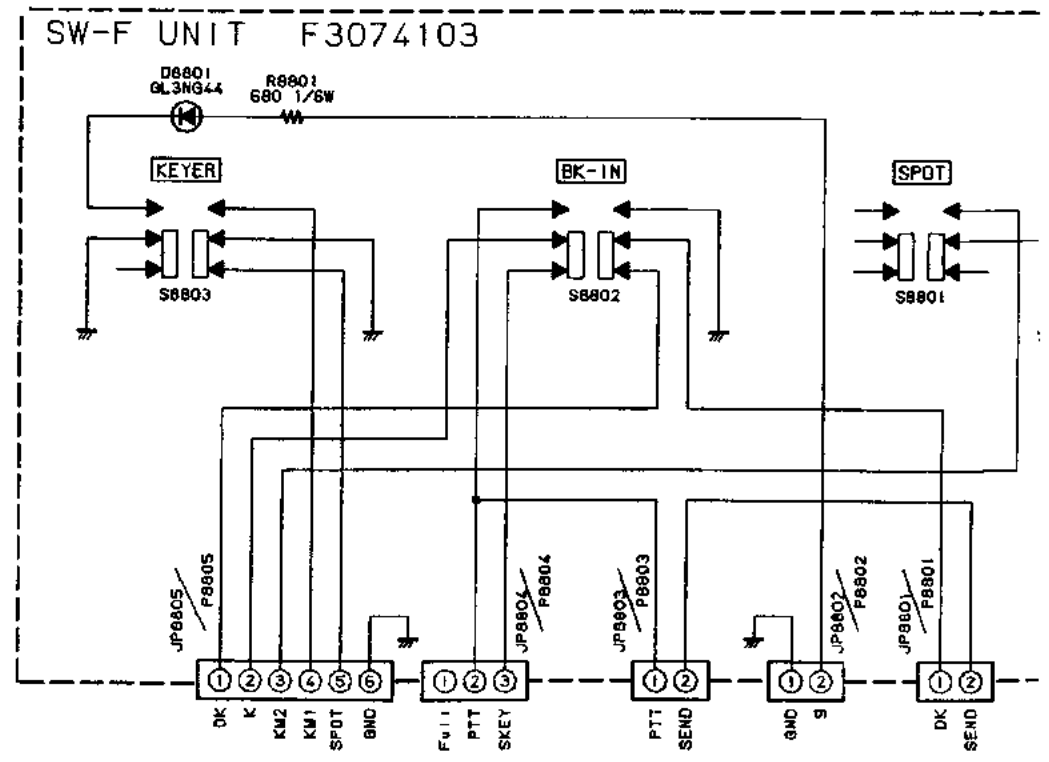

(SW F UNIT schematic diagram)

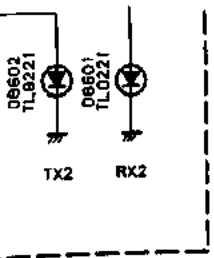

schematic diagram)

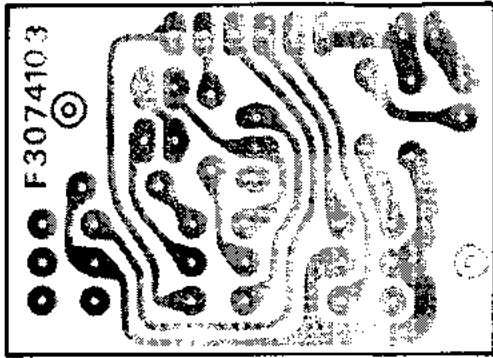

(obverse view of "solder" side)

W F UNIT

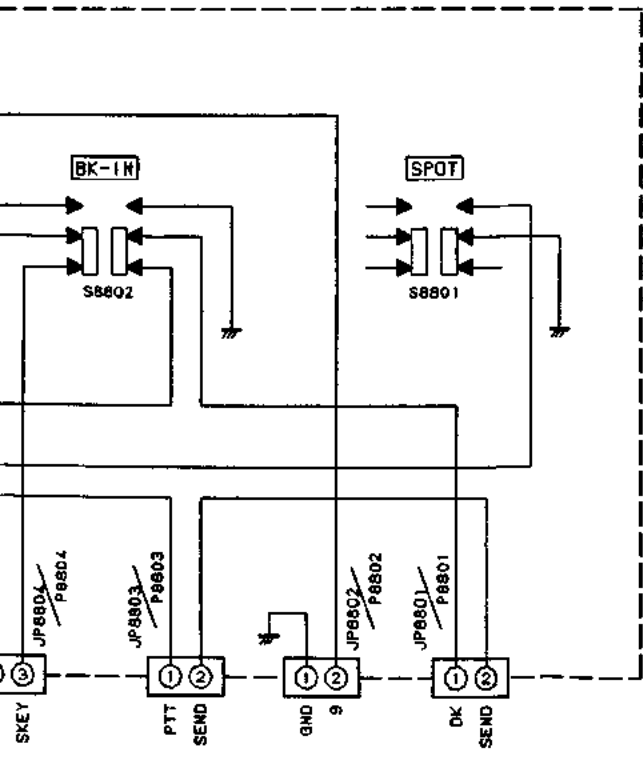

T schematic diagram)

For Service Manuals Contact
MAURITRON TECHNICAL SERVICES
 8 Cherry Tree Rd, Chinnor
 Oxon OX9 4QY
 Tel: 01844-351694 Fax: 01844-352554
 Email: enquiries@maurtron.co.uk

SW E UNIT

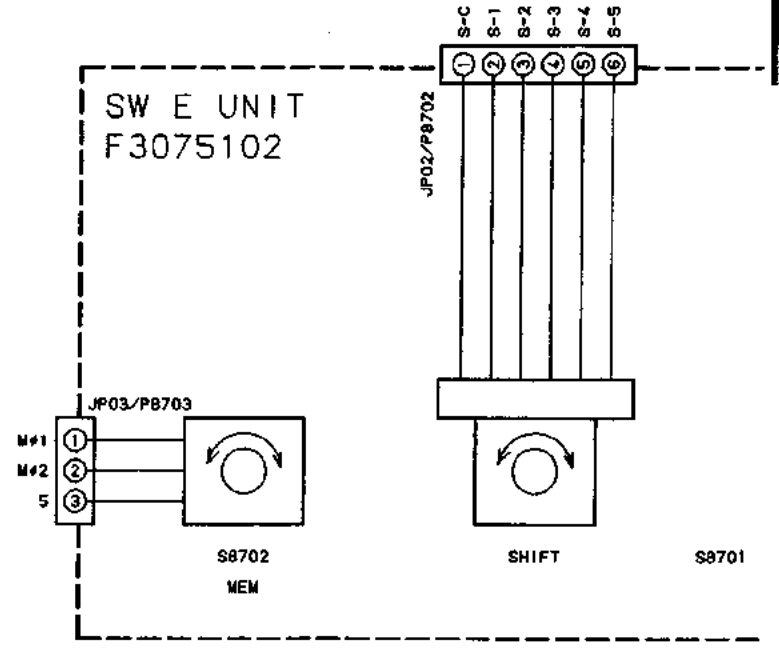

(SW E UNIT schematic diagram)

SW E UNIT

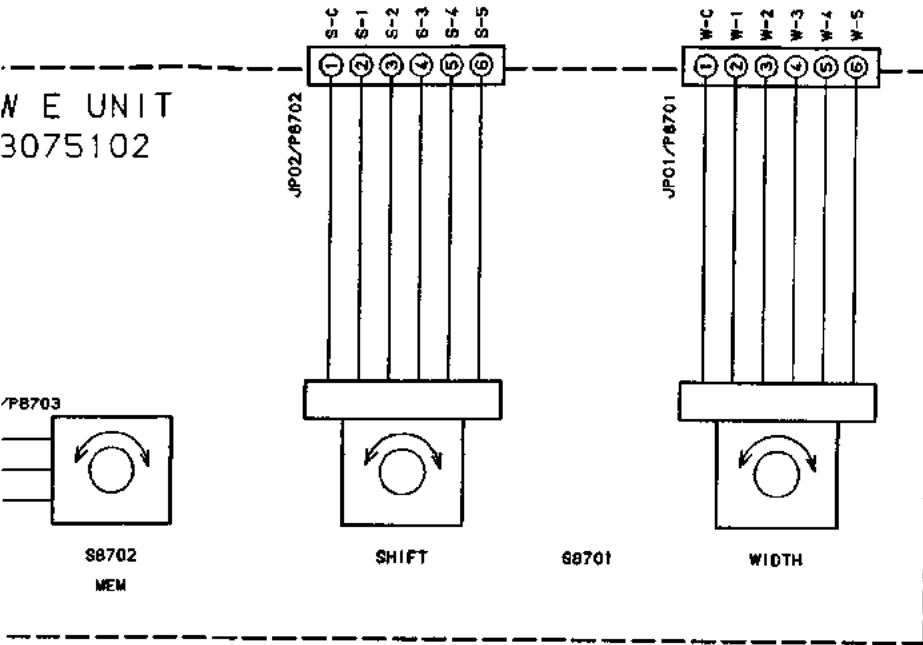

(SW E UNIT schematic diagram)

For Service Manuals Contact
MAURITRON TECHNICAL SERVICES
 8 Cherry Tree Rd, Chinnor
 Oxon OX9 4QY
 Tel:- 01844-351694 Fax:- 01344-352554
 Email:- enquiries@mauritron.co.uk

Switch G, H & K Units Parts Lists

ADD	CODE NO	DESCRIPTION	DEVICE	TYP	VAL
SW-G UNIT					
J 8901	P0090621	CONNECTOR			
JP8901	T9205890	WIRE-ASSY 2710			
JP8902	T9205891	WIRE-ASSY 2710			
JP8903	T9205892	WIRE-ASSY 2710			
R 8901	J2225103	CARBON FILM RES.	RD16UJ102	1K	1/6W
R 8902	J2225103	CARBON FILM RES.	RD16UJ102	1K	1/6W
S 8901	Q9000525	ROTARY CODE SWITCH	EC16B40B		
VR8901	J62800104	POT.	RK12 2KC/10KB		
SW-H UNIT					
D 9001	G2090458	LED	TLG221		
JP9001	T9205893	WIRE-ASSY 2710			
S 9001	N4090065	PUSH SWITCH	KHC10902		
S 9002	N4090065	PUSH SWITCH	KHC10902		
S 9003	N4090065	PUSH SWITCH	KHC10902		
S 9004	N4090065	PUSH SWITCH	KHC10902		
S 9005	N4090065	PUSH SWITCH	KHC10902		
S 9006	N4090065	PUSH SWITCH	KHC10902		
SW-K UNIT					
D 9101	G2090460	LED	TLR221		
JP9101	T9205894	WIRE-ASSY 2710			
S 9101	N5090029	PUSH SWITCH	JPM1990-0101		

For Service Manuals Contact
MAURITRON TECHNICAL SERVICES
8 Cherry Tree Rd, Chinnor
Oxon OX9 4QY
Tel: 01844-351694 Fax: 01844-352554
Email: enquiries@mauritron.co.uk

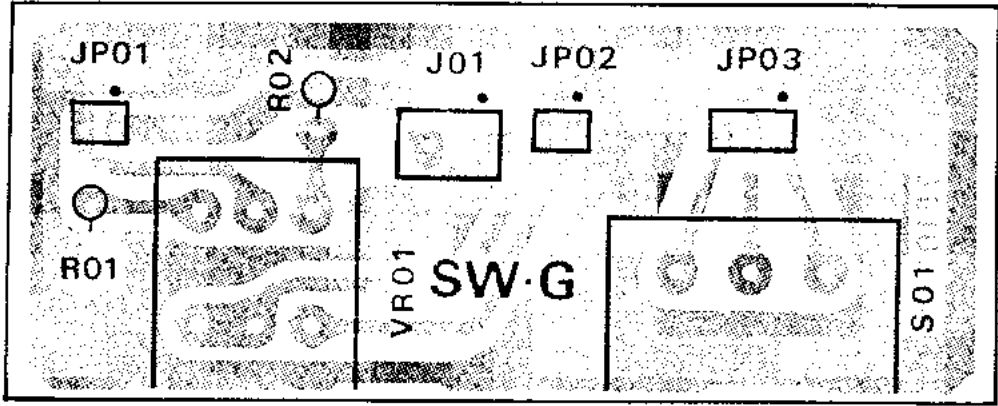

(obverse view of "component" side)

For Service Manuals Contact
 MAURITRON TECHNICAL SER. "CES"
 8 Cherry Tree Rd, Chinnor
 Oxon OX9 4QY
 Tel: 01844-351694 Fax: 01844-352554
 Email: enquiries@mauritron.co.uk

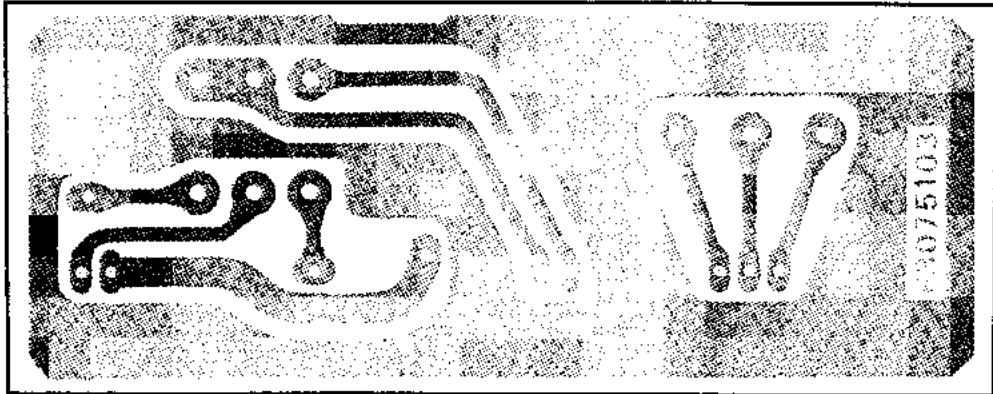

(obverse view of "solder" side)

SW G UNIT

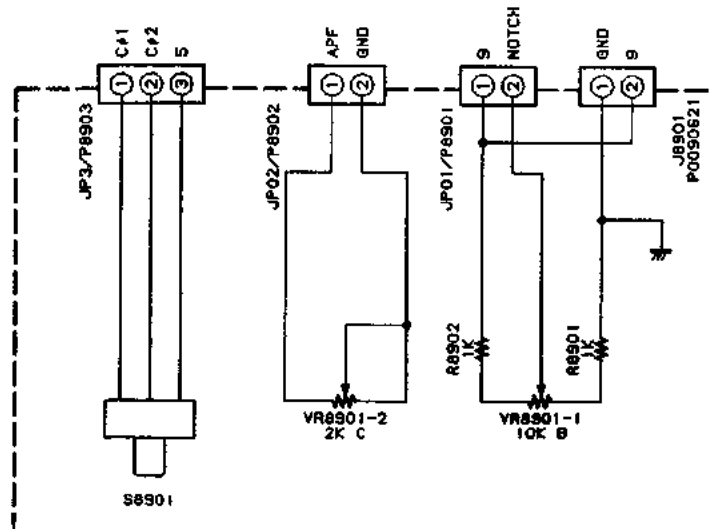

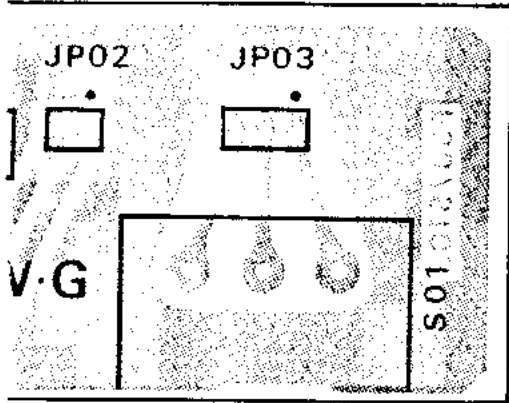

(reverse view of "component" side)

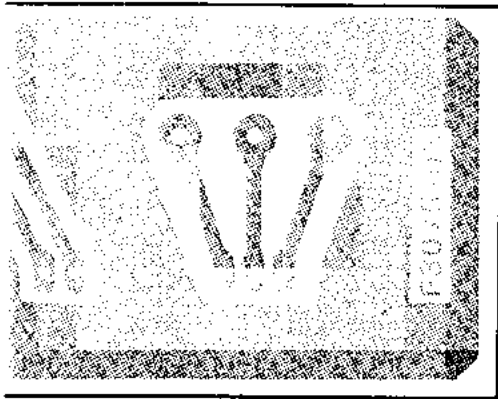

(reverse view of "solder" side)

For Service Manuals Contact
MAURITRON TECHNICAL SERVICES
 8 Cherry Tree Rd, Chinnor
 Oxon OX9 4QY
 Tel: 01844-351694 Fax: 01844-352554
 Email: enquiries@mauritron.co.uk

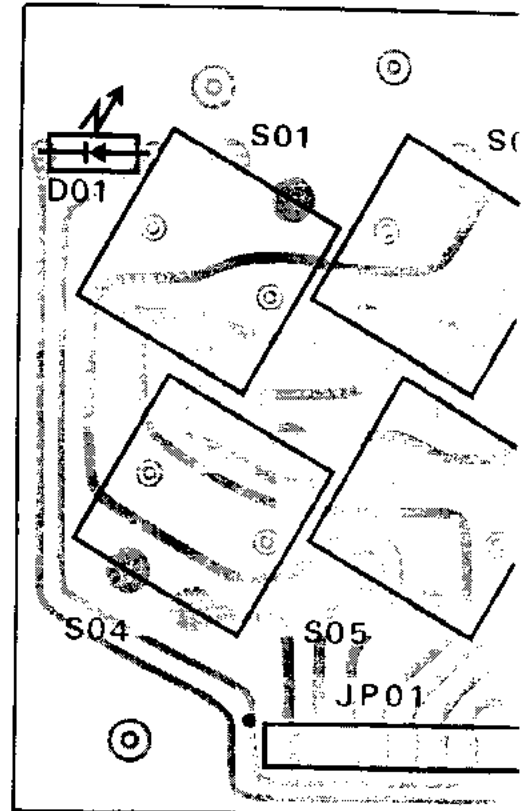

(reverse view of "component" side)

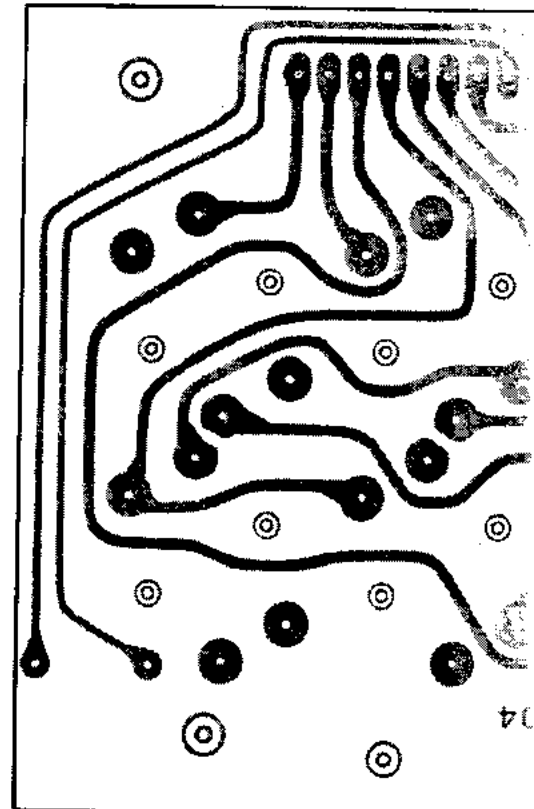

(reverse view of "component" side)

SW H UNIT

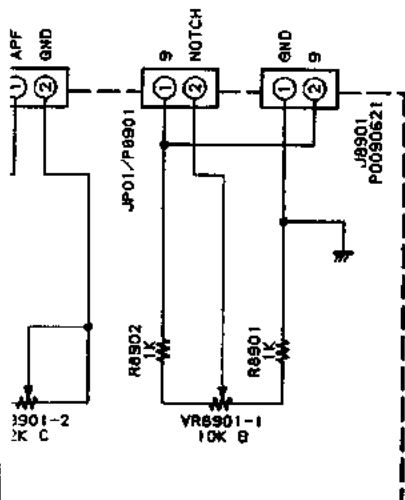

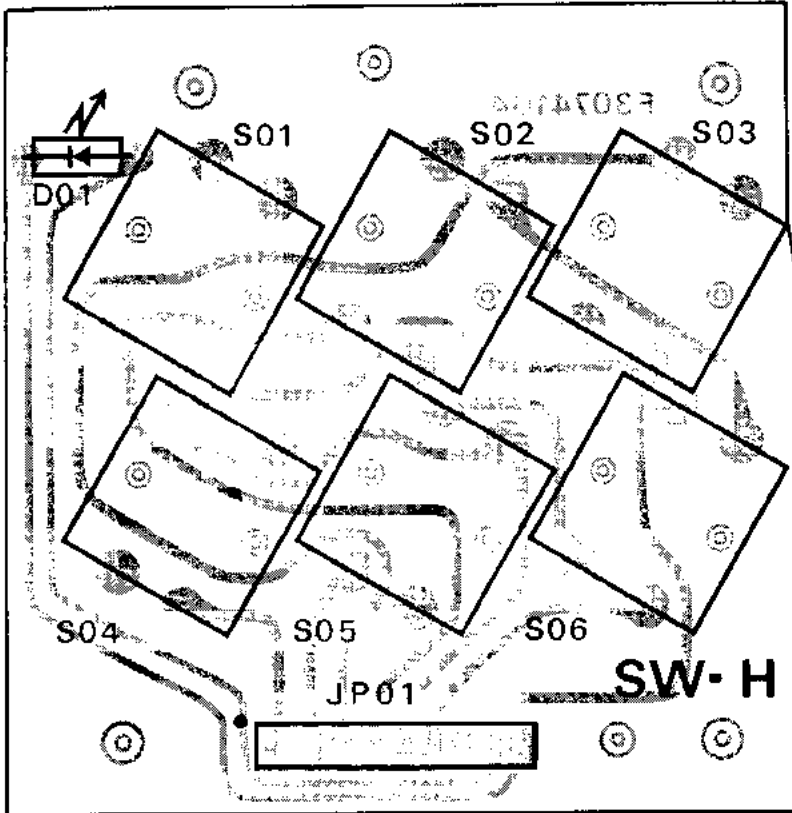

(obverse view of "component" side)

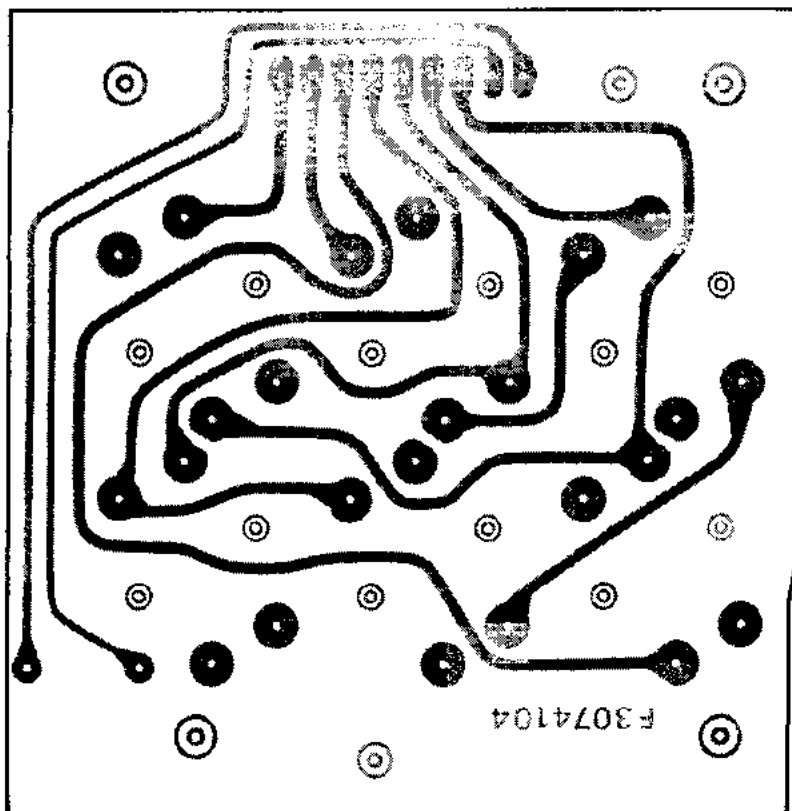

(obverse view of "solder" side)

SW H UNIT

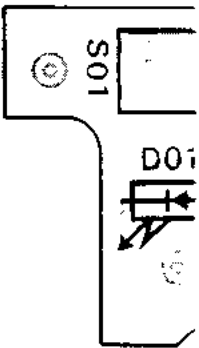

(obverse view of

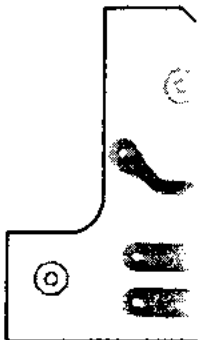

(obverse view of

SW K U

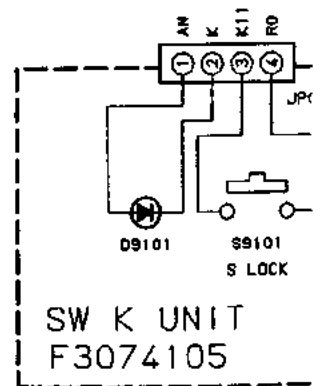

(SW K UNIT schemat

Switch G, H & K Units Layout & Schematic Diagrams

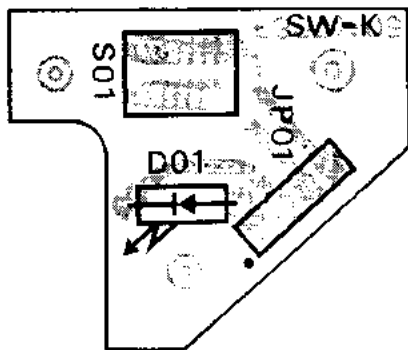

(obverse view of "component" side)

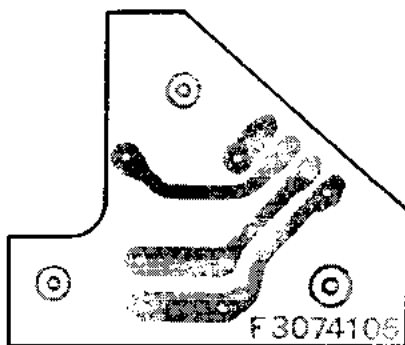

(obverse view of "solder" side)

SW K UNIT

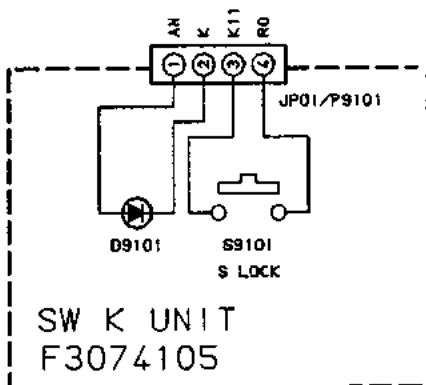

(SW K UNIT schematic diagram)



(obverse view of "solder" side)

SW G UNIT

For Service Manuals Contact
MAURITRON TECHNICAL SERVICES
 8 Cherry Tree Rd, Chinnor
 Oxon OX9 4QY
 Tel: 01844-351694 Fax: 01844-352554
 Email: enquiries@mauritron.co.uk

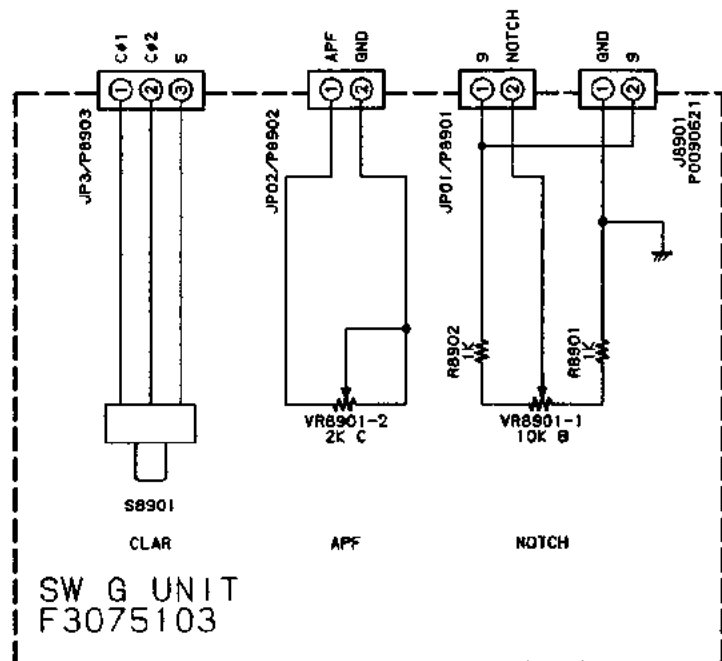

NOTE:
 RESISTOR VALUES ARE IN Ω, 1/6W ;
 UNLESS OTHERWISE NOTED.

(SW G UNIT schematic diagram)

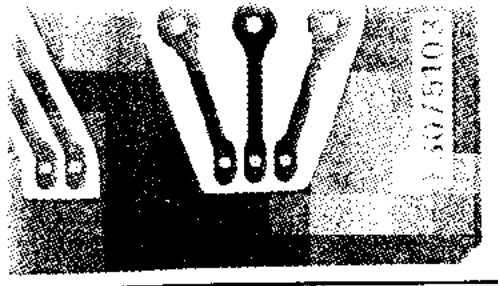

obverse view of "solder" side)

UNIT

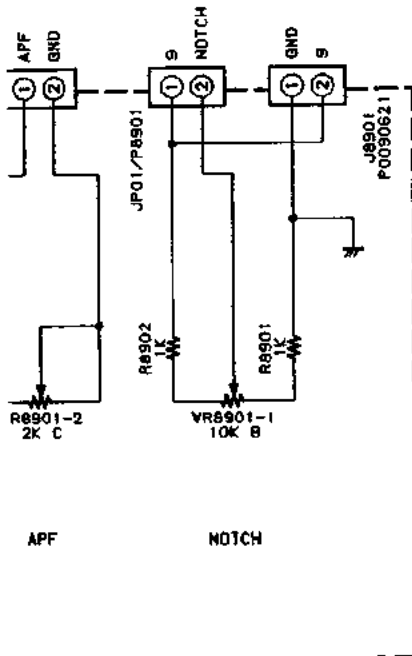

NOTE:
RESISTOR VALUES ARE IN Ω, 1/6W ;
UNLESS OTHERWISE NOTED.

schematic diagram)



(obverse view of

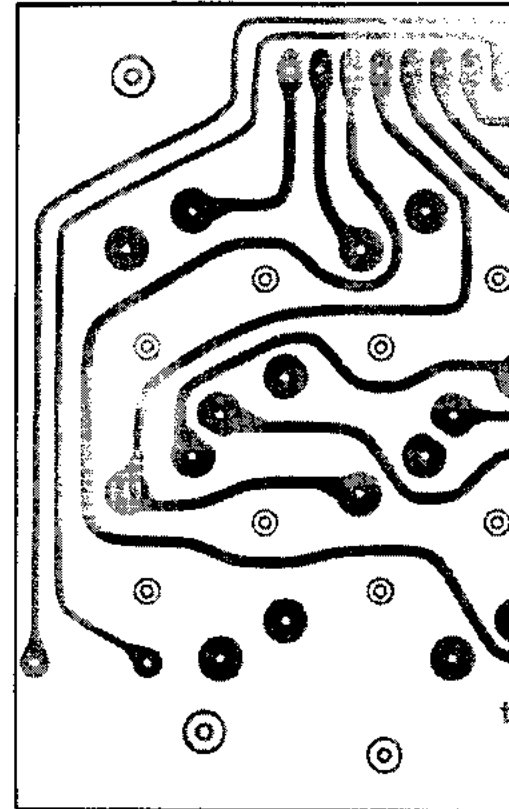

(obverse view

SW H UNIT

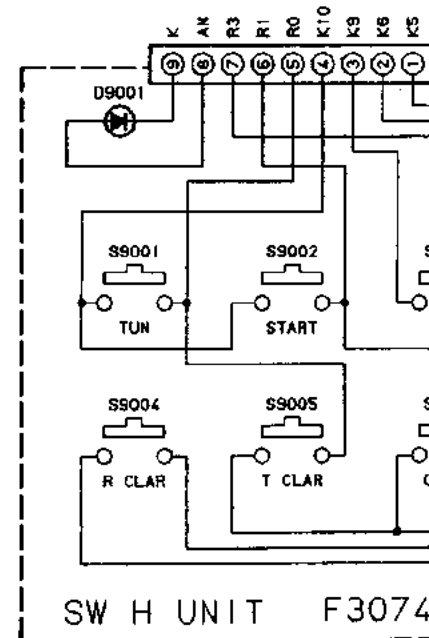

SW H UNIT F3074

(SW H UNIT schematic

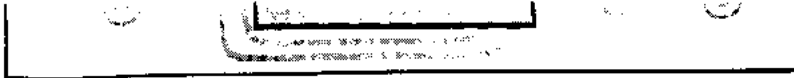

(obverse view of "component" side)

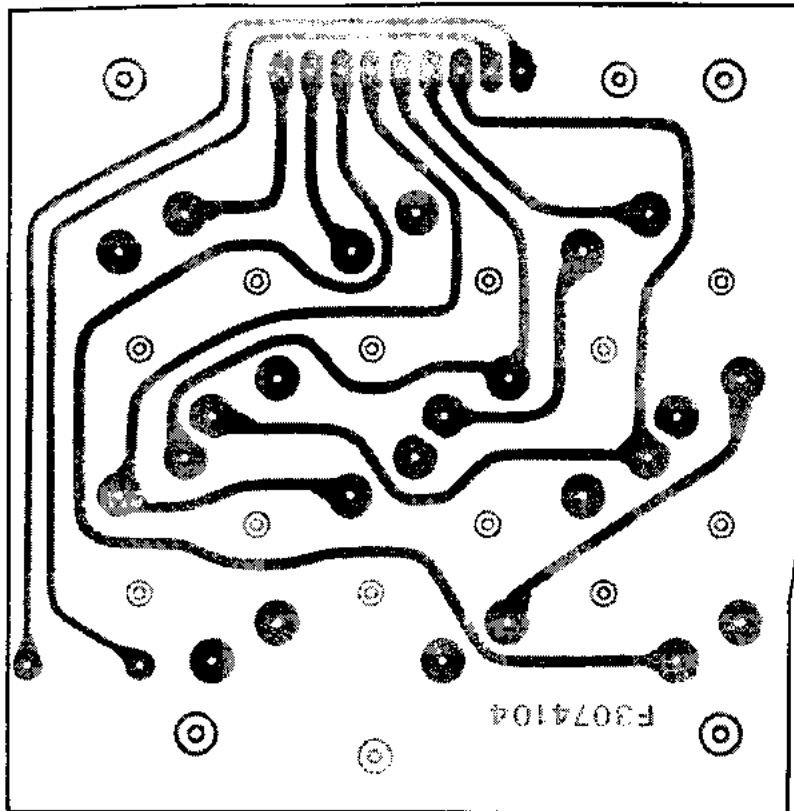

(obverse view of "solder" side)

SW H UNIT

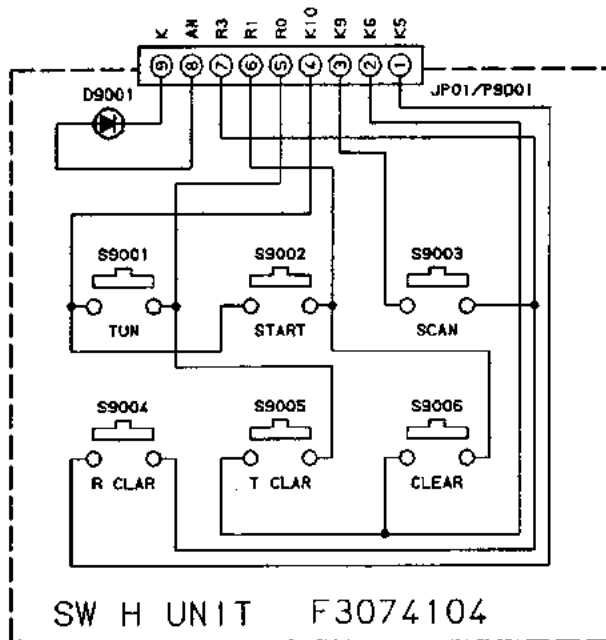

SW H UNIT F3074104

(SW H UNIT schematic diagram)

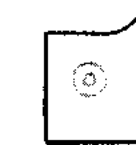

(obverse)

SW K UNIT

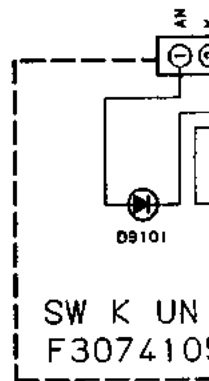

(SW K UNIT schematic diagram)



(obverse view of "solder" side)

SW K UNIT

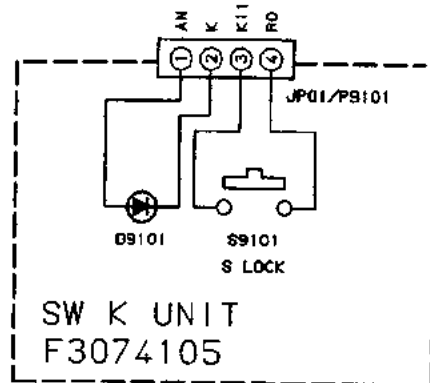

(SW K UNIT schematic diagram)

For Service Manuals Contact
MAURITRON TECHNICAL SERVICES
 8 Cherry Tree Rd, Chinnor
 Oxon OX9 4QY
 Tel: 01844-351694 Fax: 01844-352554
 Email: enquiries@mauritron.co.uk

VR A & B Units Parts Lists

ADD	CODE NO	DESCRIPTION	DEVICE	TYP	VAL
VR-A UNIT					
JP9401	T9205897	WIRE-ASSY 2710			
JP9402	T9205898	WIRE-ASSY 2710			
JP9403	T9205899	WIRE-ASSY 2710			
JP9404	T9205900	WIRE-ASSY 2710			
JP9405	T9205901	WIRE-ASSY 2710			
R 9401	J02225103	CARBON FILM RES.	RD16UJ103	10K	1/6W
R 9402	J02225103	CARBON FILM RES.	RD16UJ103	10K	1/6W
R 9403	J02225183	CARBON FILM RES.	RD16UJ183	18K	1/6W
R 9404	J02225392	CARBON FILM RES.	RD16UJ392	3.9K	1/6W
VR9401	J62800105	POT.	RK12 10KB/10KB		
VR9402	J62800105	POT.	RK12 10KB/10KB		
VR9403	J62800105	POT.	RK12 10KB/10KB		
VR9404	J62800105	POT.	RK12 10KB/10KB		
VR-B UNIT					
JP9411	T9205902	WIRE-ASSY 2710			
VR9411	J60800161	POT.	RK097111T	50KB/SW	

For Service Manuals Contact
MAURITRON TECHNICAL SERVICES
 8 Cherry Tree Rd, Chinnor
 Oxon OX9 4QY
 Tel:- 01844-351634 Fax:- 01844-352554
 Email:- enquiries@mauritron.co.uk

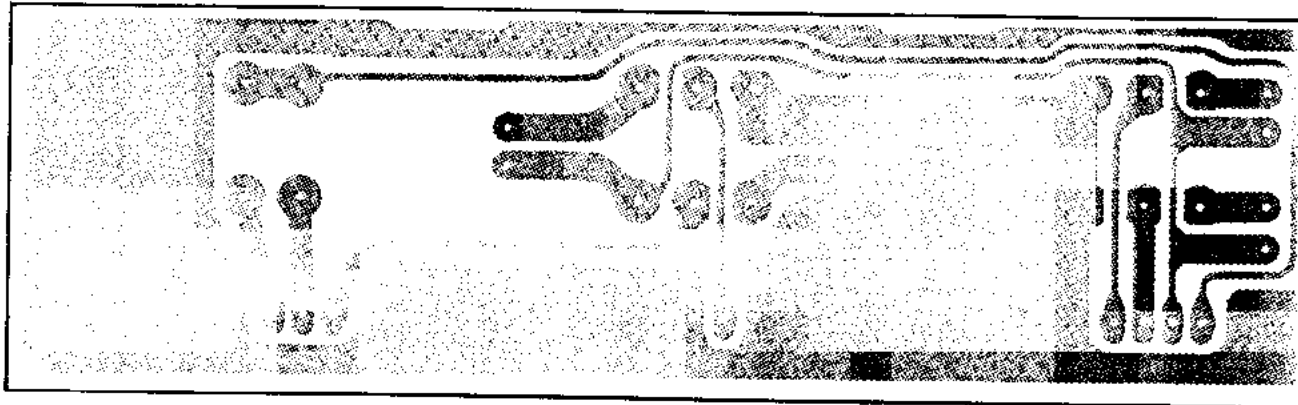
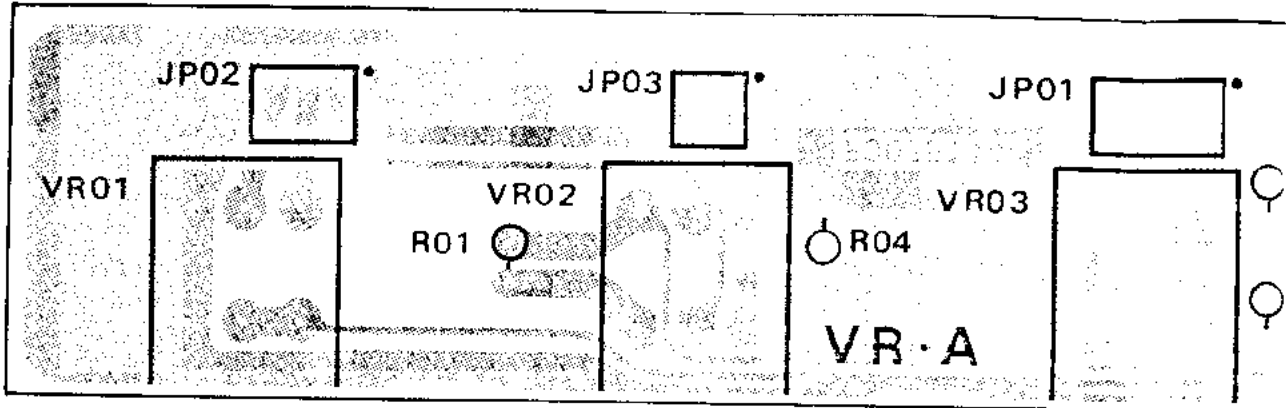

VR A UNIT

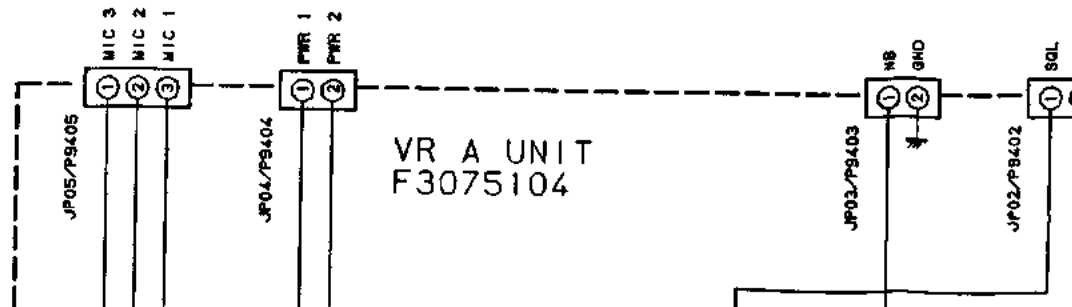

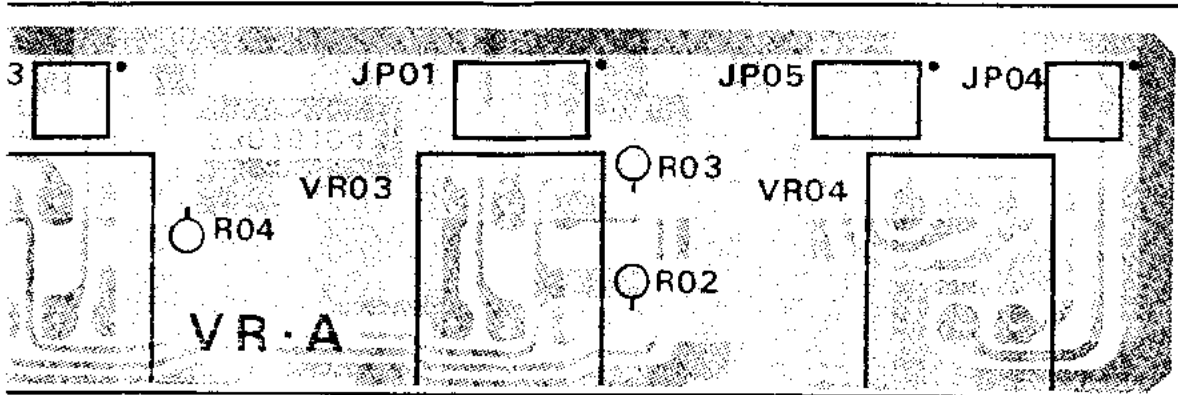

(obverse view of "component" side)

For Service Manuals Contact
MAURITRON TECHNICAL SERVICES
 8 Cherry Tree Rd, Chinnor
 Oxon OX9 4QY
 Tel: 01844-351694 Fax: 01544-352554
 Email: enquiries@mauritron.co.uk

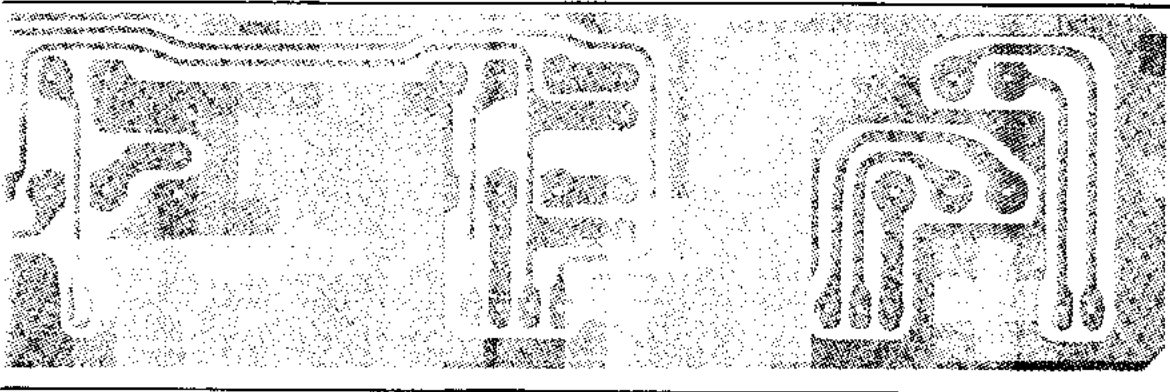

(obverse view of "solder" side)

VR A UNIT

VR A UNIT
 3075104

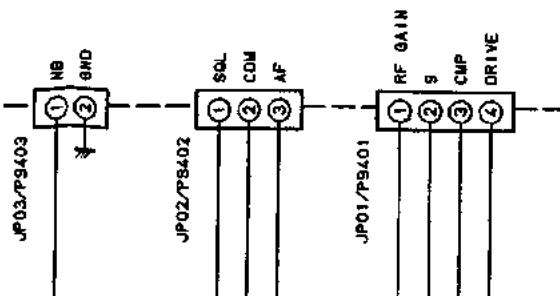



component" side)



of "solder" side)

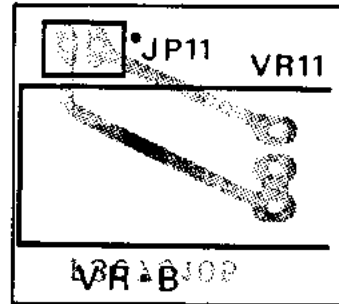

(obverse view of "component" side)

(obvers

VR B UNIT

VR A & B Units Layouts & Schematics

For Service Manuals Contact
MAURITRON TECHNICAL SERVICES
8 Cherry Tree Rd, Chinnor
Oxon OX9 4QY
Tel: 01844-351694 Fax: 01844-352554
Email: enquiries@mauritron.co.uk

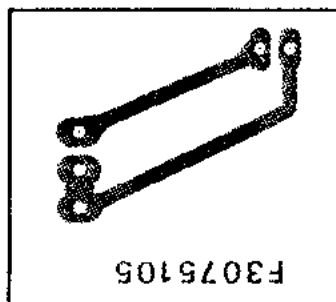
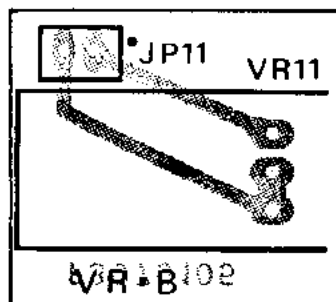

(obverse view of "component" side) (obverse view of "solder" side)

VR B UNIT

VR-B-UNIT
F3075105

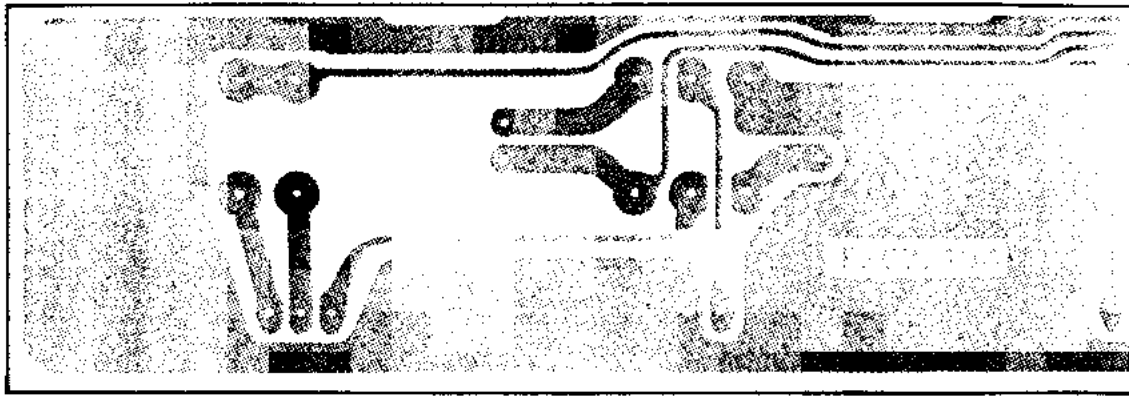

VR A UNIT

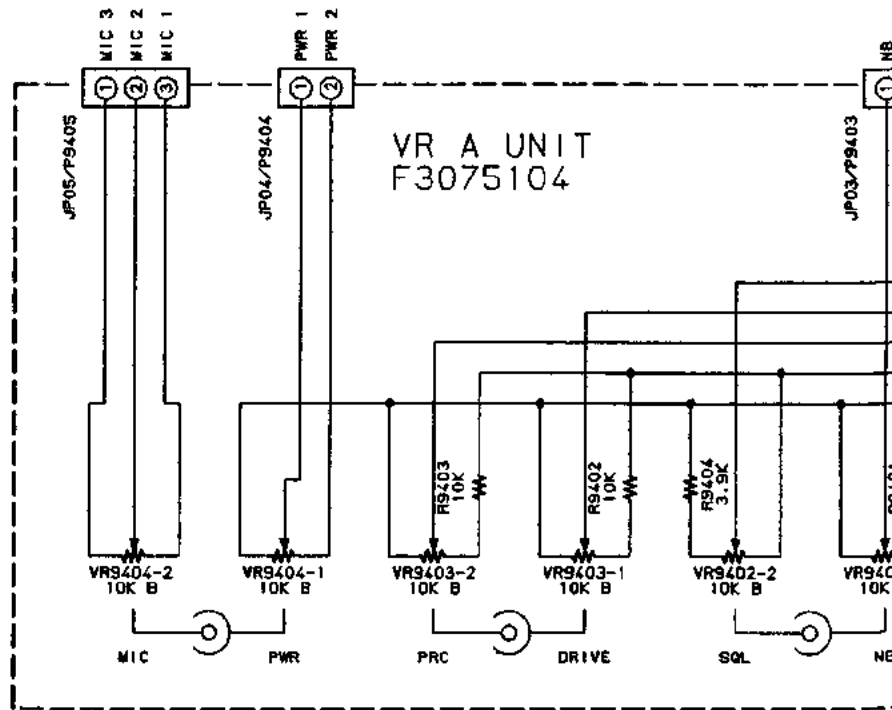

(VR A UNIT schematic diagram)

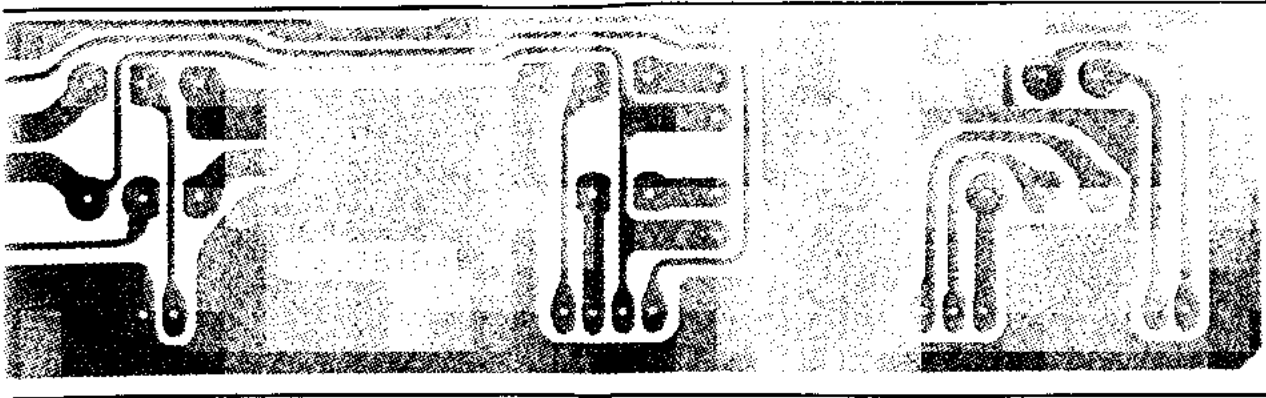

(obverse view of "solder" side)

VR A UNIT

For Service Manuals Contact
MAURITRON TECHNICAL SERVICES
 8 Cherry Tree Rd, Chinnor
 Oxon OX9 4QY
 Tel: 01844-351694 Fax: 01844-352554
 Email: enquiries@mauritron.co.uk

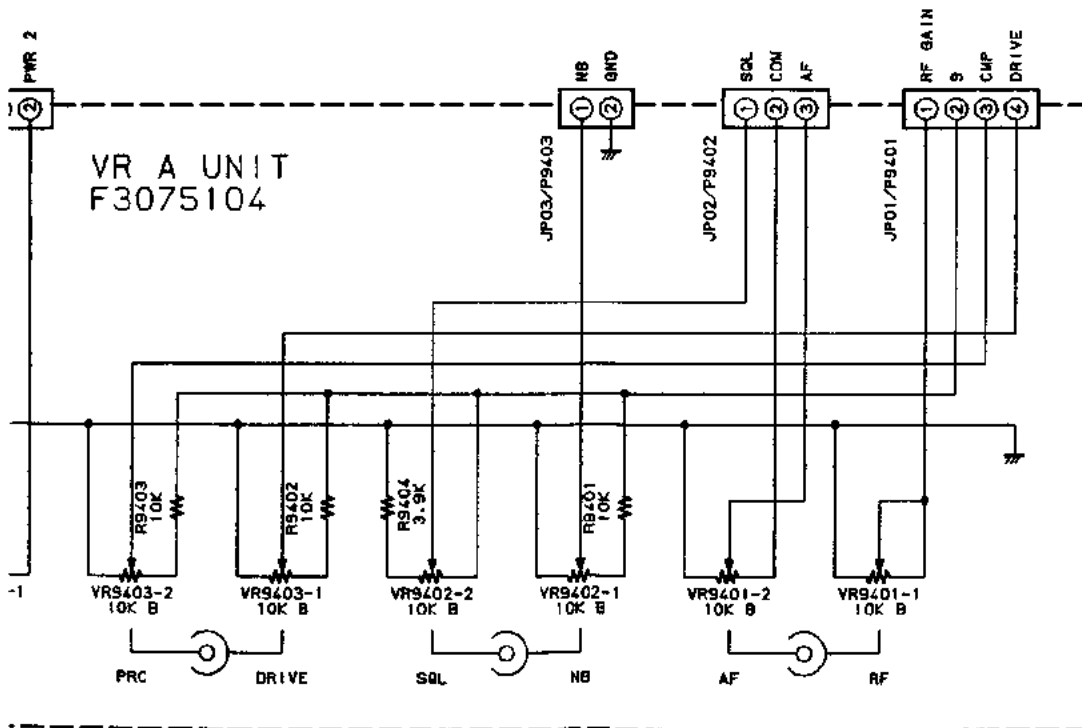

(VR A UNIT schematic diagram)

NOTE:
 RESISTOR VALUES ARE IN Ω , K, M, B, S, W :
 UNLESS OTHERWISE NOTED.

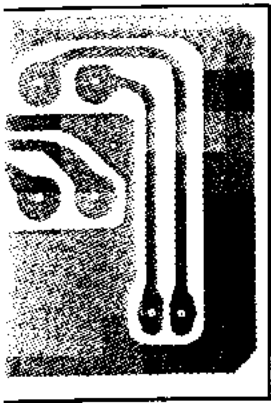

of "solder" side)

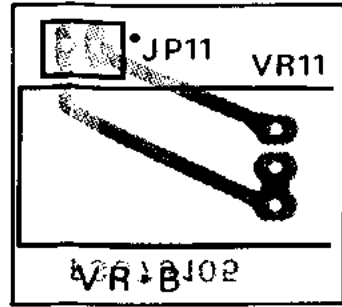

(obverse view of "component" side) (obverse view)

VR B UNIT



1/6W

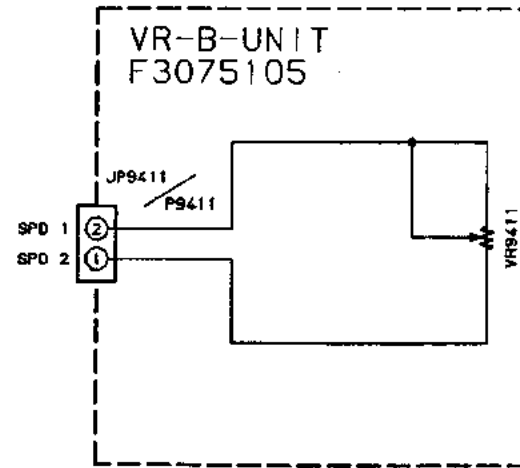

(VR B UNIT schematic diagram)

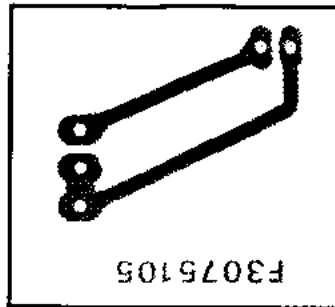
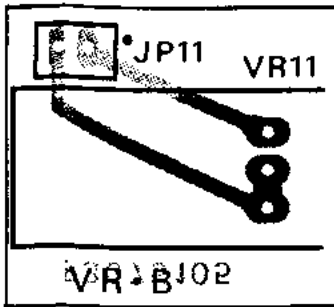

obverse view of "component" side) (obverse view of "solder" side)

VR B UNIT

For Service Manuals Contact
MAURITRON TECHNICAL SERVICES
 8 Cherry Tree Rd, Chinnor
 Oxon OX29 4QY
 Tel: 01844-351634 Fax: 01844-352554
 Email: enquiries@maurtron.co.uk

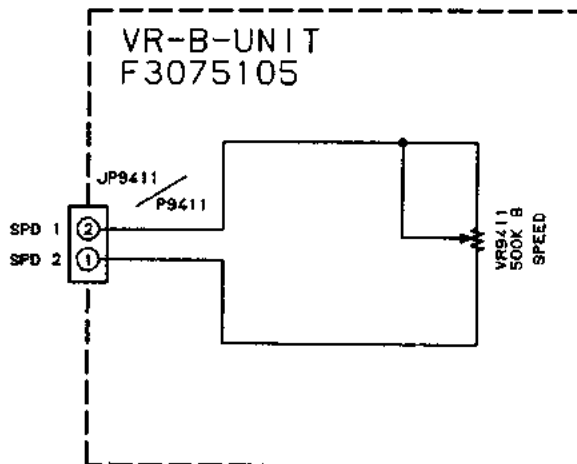

(VR B UNIT schematic diagram)

SHP Unit Parts List

ADD	CODE NO	DESCRIPTION	DEVICE			TYP	VAL
** UNIT NAME : SHP-UNIT							
C 9601	K46160004	AL.ELECTRO.CAP.	35V4R7M4X7TR2	4.7uF	35V		
C 9602	K46160004	AL.ELECTRO.CAP.	35V4R7M4X7TR2	4.7uF	35V		
C 9604	K46120004	AL.ELECTRO.CAP.	16V100M4X7TR2	10uF	16V		
C 9605	K28129001	CERAMIC CAP.	EP050Y103N-A	0.01uF	16V	Y	
C 9606	K46120004	AL.ELECTRO.CAP.	16V100M4X7TR2	10uF	16V		
C 9607	K28149001	CERAMIC CAP.	TP050F223Z-A-B	0.022uF	25V	F	
C 9608	K28149001	CERAMIC CAP.	TP050F223Z-A-B	0.022uF	25V	F	
C 9609	K28129001	CERAMIC CAP.	EP050Y103N-A	0.01uF	16V	Y	
C 9610	K46170030	AL.ELECTRO.CAP.	50V010M4X7TR2	1uF	50V		
C 9611	K46140006	AL.ELECTRO.CAP.	25V221M8X11TR5	220uF	25V		
C 9612	K46140006	AL.ELECTRO.CAP.	25V221M8X11TR5	220uF	25V		
D 9601	G2090188	DIODE	HZ5C1				
J 9601	P0090624	CONNECTOR	SC25-05WS				
J 9602	P0090622	CONNECTOR	SC25-03WS				
J 9603	P0090622	CONNECTOR	SC25-03WS				
J 9604	P0090622	CONNECTOR	SC25-03WS				
Q 9601	G1090649	IC	M5218L				
Q 9602	G1090989	IC	M5216L				
Q 9603	G1090283	IC	UPD4066BC				
R 9601	J07225104	CARBON FILM RES.	RD16TPJ104	100K	100K		1/6W
R 9602	J07225103	CARBON FILM RES.	RD16TPJ103	10K	10K		1/6W
R 9603	J07225472	CARBON FILM RES.	RD16TPJ472	4.7K	4.7K		1/6W
R 9604	J07225104	CARBON FILM RES.	RD16TPJ104	100K	100K		1/6W
R 9605	J07225103	CARBON FILM RES.	RD16TPJ103	10K	10K		1/6W
R 9606	J07225472	CARBON FILM RES.	RD16TPJ472	4.7K	4.7K		1/6W
R 9607	J07225473	CARBON FILM RES.	RD16TPJ473	47K	47K		1/6W
R 9608	J07225334	CARBON FILM RES.	RD16TPJ334	330K	330K		1/6W
R 9609	J07225470	CARBON FILM RES.	RD16TPJ470	47	47		1/6W
R 9610	J07225473	CARBON FILM RES.	RD16TPJ473	47K	47K		1/6W
R 9611	J07225334	CARBON FILM RES.	RD16TPJ334	330K	330K		1/6W
R 9612	J07225470	CARBON FILM RES.	RD16TPJ470	47	47		1/6W
R 9613	J07225682	CARBON FILM RES.	RD16TPJ682	6.8K	6.8K		1/6W
R 9614	J07225103	CARBON FILM RES.	RD16TPJ103	10K	10K		1/6W
R 9615	J07225103	CARBON FILM RES.	RD16TPJ103	10K	10K		1/6W
R 9616	J07225103	CARBON FILM RES.	RD16TPJ103	10K	10K		1/6W
R 9617	J07225152	CARBON FILM RES.	RD16TPJ152	1.5K	1.5K		1/6W
R 9618	J07225103	CARBON FILM RES.	RD16TPJ103	10K	10K		1/6W

For Service Manuals Contact
MAURITRON TECHNICAL SERVICES
 8 Cherry Tree Rd, Chinnor
 Oxon OX9 4QY
 Tel: 01844-351694 Fax: 01844-352554
 Email: enquiries@mauritron.co.uk

Notes

For Service Manuals Contact
MAURITRON TECHNICAL SERVICES
8 Cherry Tree Rd, Chinnor
Oxon OX9 4QY
Tel: 01844 351691 Fax: 01844 352554
Email: enquires@maurtron.co.uk

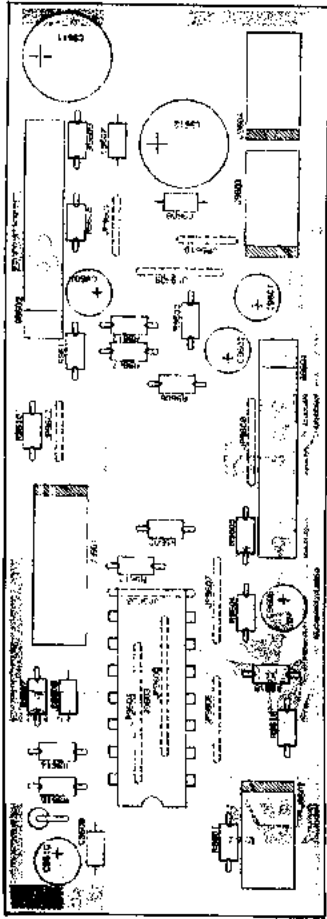

(obverse view of "component" side)

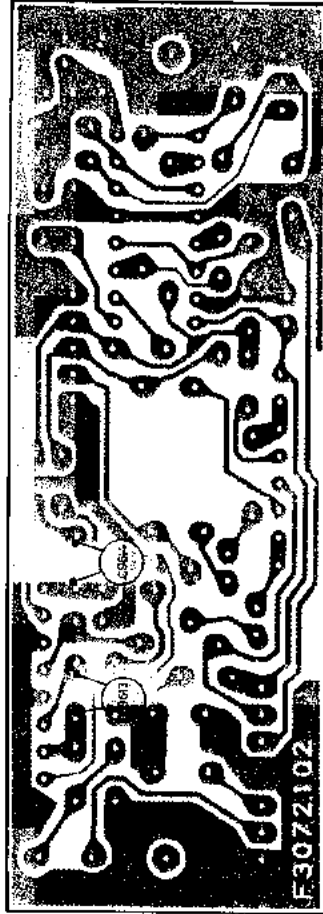

(obverse view of "chip-only" side)

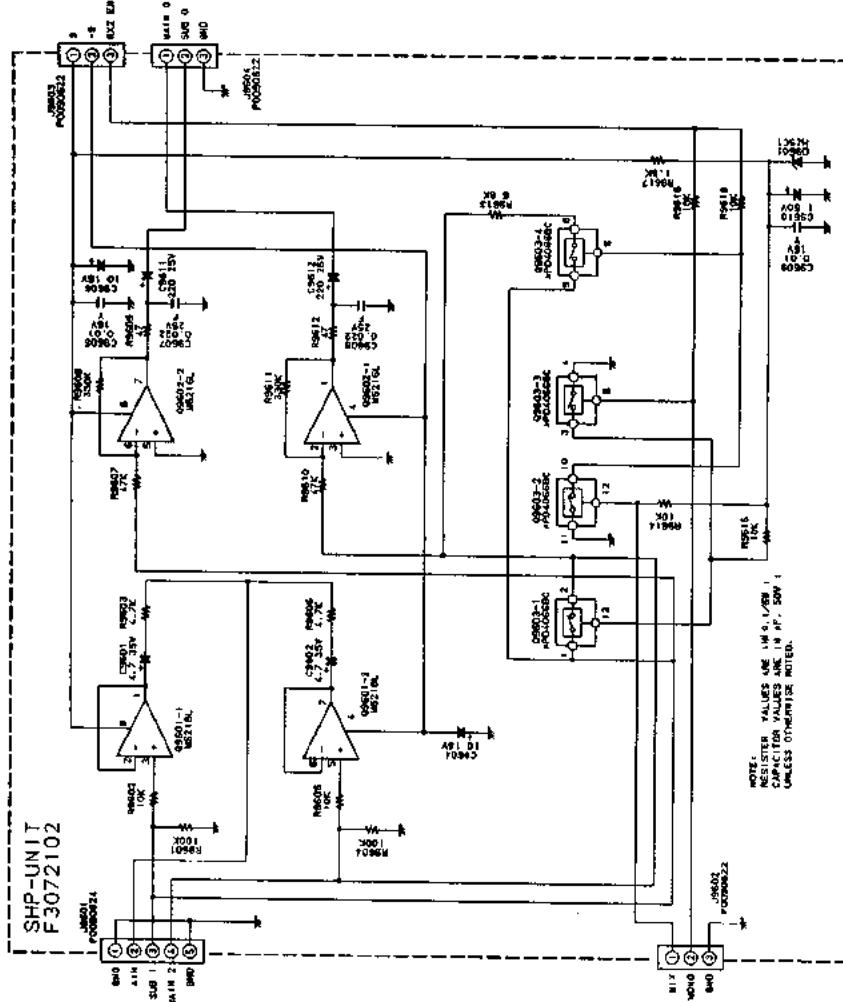

(schematic diagram)

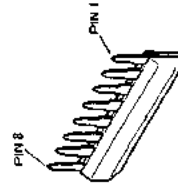

M5216L (09602)



M5218L (09601)

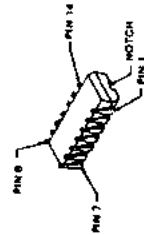

IPD4096BC (09603)

HP & Mic Units Parts Lists

ADD	CODE NO	DESCRIPTION	DEVICE	TYP	VAL
HP-UNIT					
J 9951	P1090639	CONNECTOR	HLJ2335-01-3010		
J 9952		With J9951			
JP9951	T9205903	WIRE-ASSY 2710			
JP9952	T9205904	WIRE-ASSY 2710			
JP9953	T9205922	WIRE-ASSY 2710			
MIC-JACK UNIT					
C 9961	K12171102	CERAMIC CAP.	DD104E102P50	0.001uF	50V
J 9961	P0090779	CONNECTOR	FM214-8SS(A) IN		
JP9961	T9205905	WIRE-ASSY 2710			
JP9962		With JP9961			
JP9963	Q6100017	JUMPER WIRE	0.6-7.5		
JP9964	Q6100017	JUMPER WIRE	0.6-7.5		

Notes

For Service Manuals Contact
MAURITRON TECHNICAL SERVICES
8 Cherry Tree Rd, Chinnor
Oxon OX9 4QY
Tel: 01844-351694 Fax: 01844-352554
Email: enquiries@maurtron.co.uk

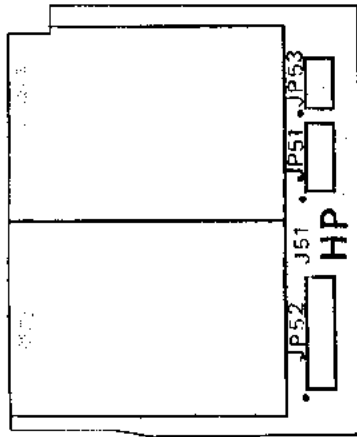

(obverse view of "component" side)

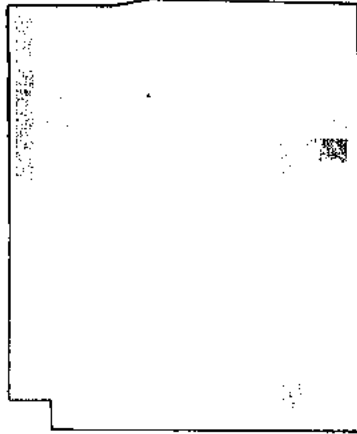

(obverse view of "solder" side)

HP UNIT

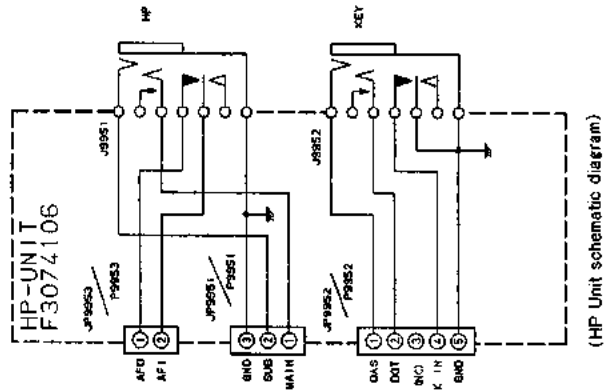

(HP Unit schematic diagram)

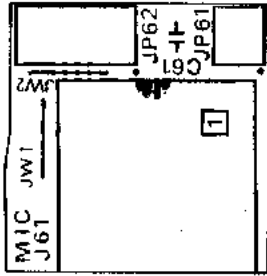

(obverse view of "component" side) (obverse view of "solder" side)

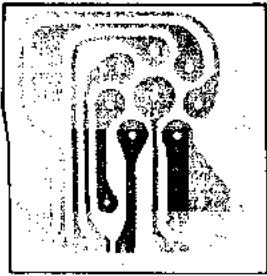

MIC UNIT

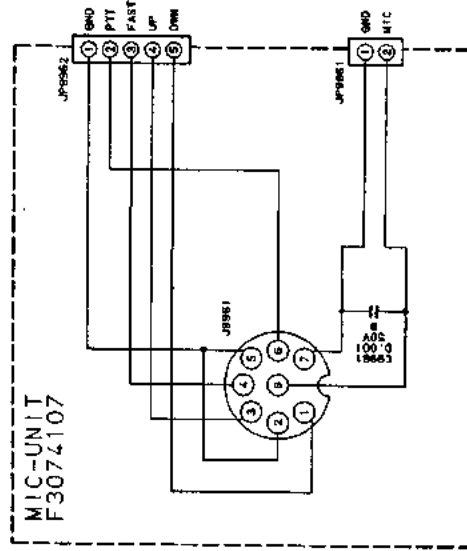

(Mic Unit schematic diagram)

For Service Manuals Contact
 MAURITRON TECHNICAL SERVICES
 8 Cherry Tree Rd, Chinnor
 Oxon OX9 4QY
 Tel: 01844-351694 Fax: 01844-352554
 Email: enquiries@mauriron.co.uk

XF-A & B Units Parts Lists

ADD	CODE NO	DESCRIPTION	DEVICE	TYP	VAL
XF-A UNIT					
C 2911	K28129001	CERAMIC CAP.	EPO50Y103N-A	0.01uF	50V
C 2912	K28129001	CERAMIC CAP.	EPO50Y103N-A	0.01uF	50V
J 2911	P1090426	CONNECTOR			
J 2912	P1090426	CONNECTOR			
XF2911	H1102159	X'TAL FILTER	XF-8.2M-202-01		

XF-B UNIT

C 2921	K28129001	CERAMIC CAP.	EPO50Y103N-A	0.01uF	50V
C 2922	K28129001	CERAMIC CAP.	EPO50Y103N-A	0.01uF	50V
J 2921	P1090426	CONNECTOR			
J 2922	P1090426	CONNECTOR			
XF2921	H1102160	X'TAL FILTER	XF-8.2M-251-01		

For Service Manuals Contact
MAURITRON TECHNICAL SERVICES
8 Cherry Tree Rd, Chinnor
Oxon OX9 4QY
Tel: 01844-351694 Fax: 01844-352554
Email: enquiries@mauritron.co.uk

Notes

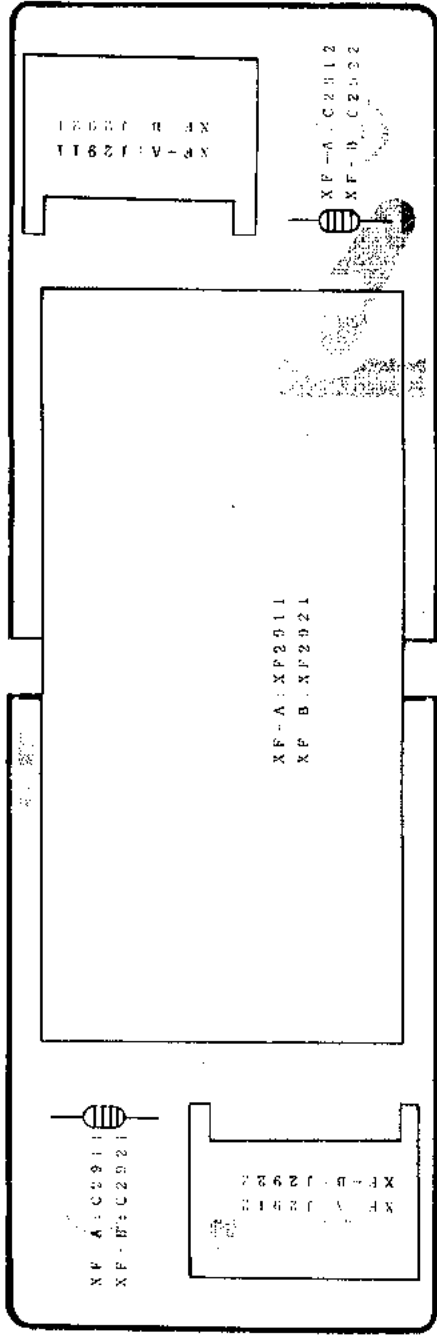

(obverse view of "component" side)

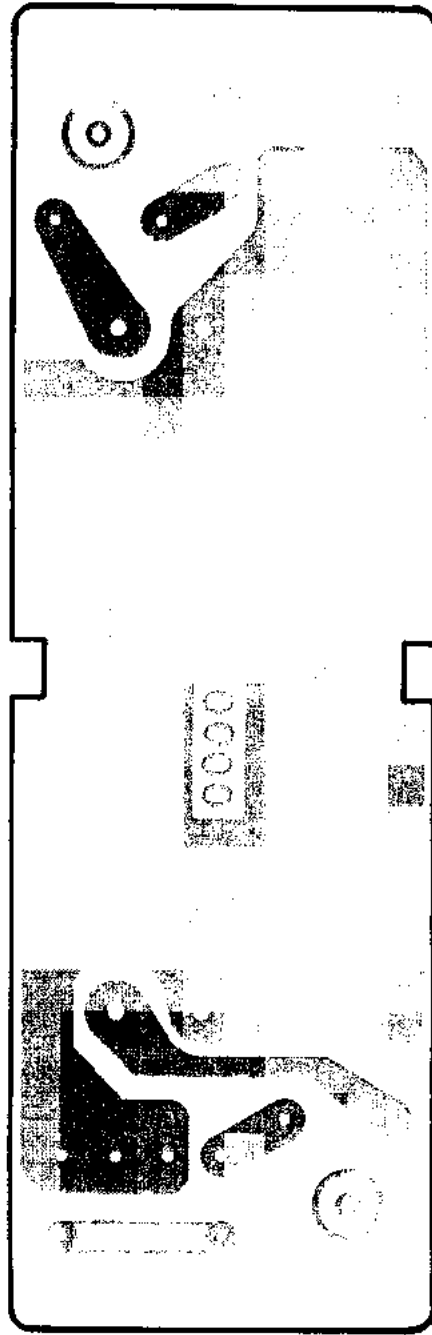

(obverse view of "solder" side)

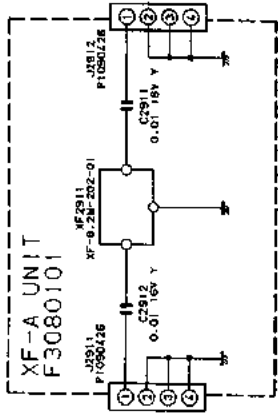

(XF-A UNIT schematic diagram)

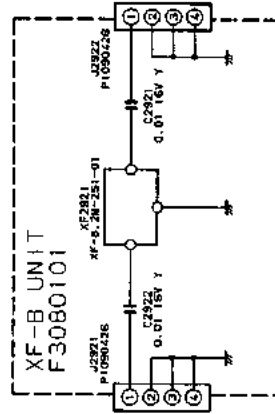

(XF-B UNIT schematic diagram)

XF-C, D, E, F & G Units Parts Lists

ADD	CODE NO	DESCRIPTION	DEVICE	TYP	VAL
XF-C UNIT					
J 2931	P1090426	CONNECTOR			
J 2932	P1090426	CONNECTOR			
XF2931	H1102161	X'TAL FILTER	XF-455K-262-01		
XF-D UNIT					
J 2941	P1090426	CONNECTOR			
J 2942	P1090426	CONNECTOR			
XF2941	H1162162	X'TAL FILTER	XF-455K-202-01		
XF-E UNIT					
J 2951	P1090426	CONNECTOR			
J 2952	P1090426	CONNECTOR			
XF2951	H1102163	X'TAL FILTER	XF-455K-501-01		
XF-F UNIT					
J 2961	P1090426	CONNECTOR			
J 2962	P1090426	CONNECTOR			
XF2961	H1102164	X'TAL FILTER	XF-455K-251-01		
XF-G UNIT					
J 2971	P1090426	CONNECTOR			
J 2972	P1090426	CONNECTOR			
XF2971	H3900290	CERAMIC FILTER	CFJ-455K13		

For Service Manuals Contact
MAURITRON TECHNICAL SERVICES
 8 Cherry Tree Rd, Chinnor
 Oxon OX9 4QY
 Tel: 01844-351694 Fax: 01844-352554
 Email: enquiries@maurtron.co.uk

Notes

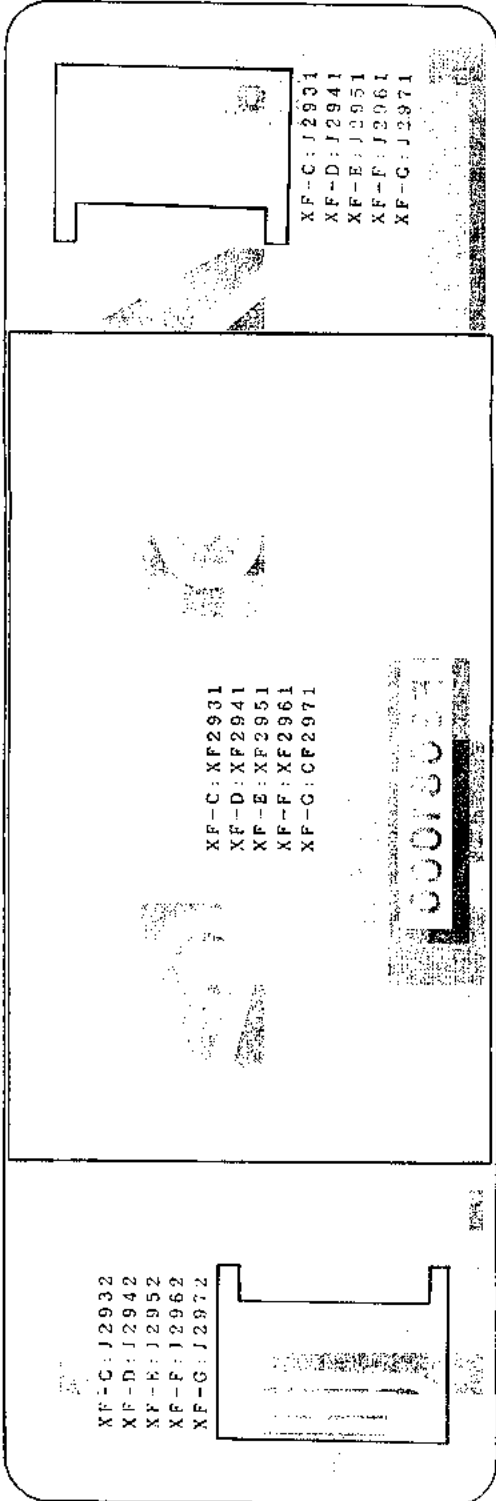

(obverse view of "component" side)

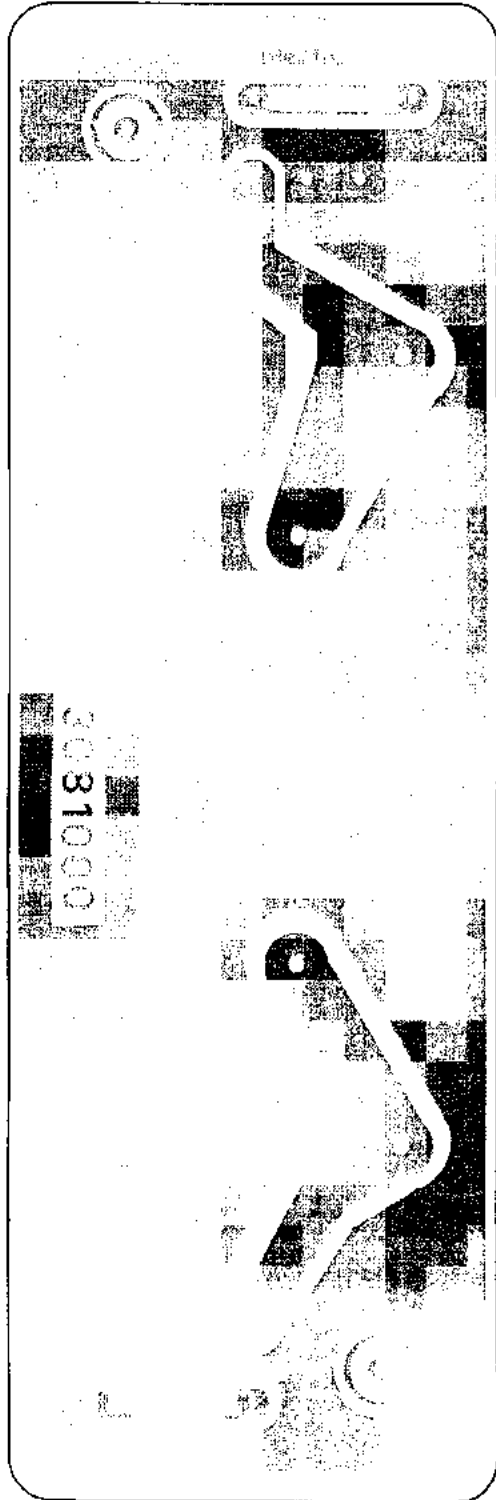

(obverse view of "solder" side)

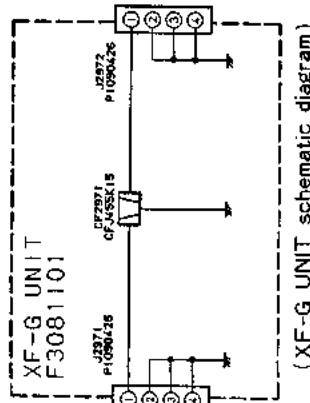
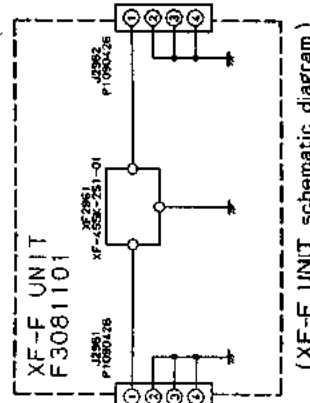
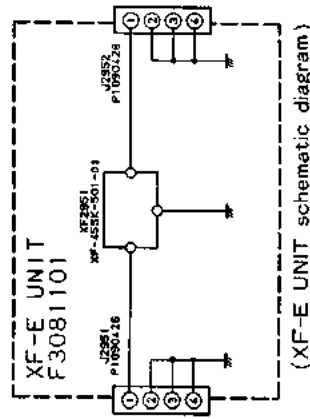
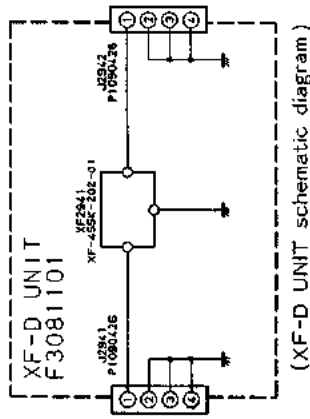
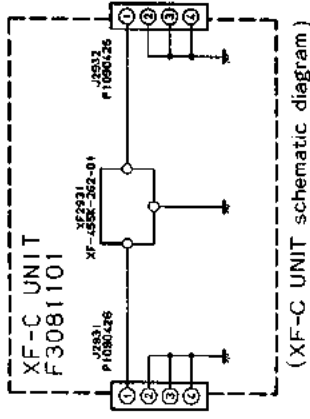

Key Ass'y A & B Parts Lists

ADD	CODE NO	DESCRIPTION	DEVICE	TYP	VAL
*** SW UNIT A ***					
D 0001	G2090509	LED	GL1EG211		
D 0002	G2090509	LED	GL1EG211		
D 0003	G2090509	LED	GL1EG211		
D 0004	G2090509	LED	GL1EG211		
D 0005	G2090509	LED	GL1EG211		
D 0006	G2090509	LED	GL1EG211		
D 0007	G2090509	LED	GL1EG211		
D 0008	G2090509	LED	GL1EG211		
D 0009	G2090509	LED	GL1EG211		
D 0010	G2090472	LED	GL1HS111		
D 0011	G2090472	LED	GL1HS111		
D 0012	G2090509	LED	GL1EG211		
D 0013	G2090472	LED	GL1HS111		
P 0001	S8100212		SB-E6-9000-0		
P 0002	S8100213		SB-E6-9001-0		
P 0003	S8100214		SB-E6-9002-0		
R 0001	J01245301	CARBON FILM RES.	RD14TJ301	300	1/4W
R 0002	J01245301	CARBON FILM RES.	RD14TJ301	300	1/4W
R 0003	J01245301	CARBON FILM RES.	RD14TJ301	300	1/4W
R 0004	J01245301	CARBON FILM RES.	RD14TJ301	300	1/4W
R 0005	J01245301	CARBON FILM RES.	RD14TJ301	300	1/4W
R 0006	J01245301	CARBON FILM RES.	RD14TJ301	300	1/4W
R 0007	J01245301	CARBON FILM RES.	RD14TJ301	300	1/4W
R 0008	J01245301	CARBON FILM RES.	RD14TJ301	300	1/4W
R 0009	J01245301	CARBON FILM RES.	RD14TJ301	300	1/4W
R 0010	J01245301	CARBON FILM RES.	RD14TJ301	300	1/4W
R 0011	J01245301	CARBON FILM RES.	RD14TJ301	300	1/4W
R 0012	J01245561	CARBON FILM RES.	RD14TJ561	560	1/4W
R 0013	J01245561	CARBON FILM RES.	RD14TJ561	560	1/4W
S 0001	N5090060		SKHRAA		
S 0002	N5090060		SKHRAA		
S 0003	N5090060		SKHRAA		
S 0004	N5090060		SKHRAA		
S 0005	N5090060		SKHRAA		
S 0006	N5090060		SKHRAA		
S 0007	N5090060		SKHRAA		
S 0008	N5090060		SKHRAA		
S 0009	N5090060		SKHRAA		
S 0010	N5090060		SKHRAA		
S 0011	N5090060		SKHRAA		
S 0012	N5090060		SKHRAA		
S 0013	N5090060		SKHRAA		
S 0014	N5090060		SKHRAA		
S 0015	N5090060		SKHRAA		
S 0016	N5090060		SKHRAA		
S 0017	N5090060		SKHRAA		
S 0018	N5090060		SKHRAA		
S 0019	N5090060		SKHRAA		
S 0020	N5090060		SKHRAA		
S 0021	N5090060		SKHRAA		
S 0022	N5090060		SKHRAA		
S 0023	N5090060		SKHRAA		
S 0024	N5090060		SKHRAA		
S 0025	N5090060		SKHRAA		

For Service Manuals Contact
MAURITRON TECHNICAL SERVICES
 8 Cherry Tree Rd, Chinnor
 Oxon OX9 4QY
 Tel:- 01844-351694 Fax:- 01844-352554
 Email:- enquiries@mauritron.co.uk

Key Ass'y A & B Parts Lists

ADD	CODE NO	DESCRIPTION	DEVICE	TYP VAL
		*** MAIN ASSY ***		
	S8000643		SB-B0-8094-1	
	S6000195	(4pcs)		
	S6000196	(2pcs)		
	S6000249	KEY TOP	A1	
	S6000250	KEY TOP	A2	
	S6000251	KEY TOP	A3	
	S6000252	KEY TOP	A4	
	S6000212	KEY TOP	B1 SB-B0-8097-1	
	S6000213	KEY TOP	B2 SB-B0-8097-2	
	S6000214	KEY TOP	B3 SB-B0-8097-3	
	S6000215	KEY TOP	B4 SB-B0-8097-4	
	S6000216	KEY TOP	B5 SB-B0-8097-5	
	S6000217	KEY TOP	B6 SB-B0-8097-6	
	S6000218	KEY TOP	B7 SB-B0-8097-7	
	S6000253	KEY TOP	C1	
	S6000254	KEY TOP	C2	
	S6000255	KEY TOP	C3	
	S6000256	KEY TOP	C4	
	S6000257	KEY TOP	C5	
	S6000258	KEY TOP	C6	
	S6000259	KEY TOP	C7	
	S6000260	KEY TOP	C8	
	S6000261	KEY TOP	C9	
	S6000262	KEY TOP	C10	
	S6000263	KEY TOP	C11	
	S6000264	KEY TOP	C12	
	S6000265	KEY TOP (2pcs)	D	
	S8000644		SB-G9-9010-0	
	U44208001	(4pcs)	M2.6X8	
	S8000645	(8pcs)	SB-F9-8000-0	

Key Ass'y A & B Parts Lists

ADD	CODE NO	DESCRIPTION	DEVICE	TYP	VAL
*** SW UNIT B ***					
D 0001	G2090509	LED	GL1EG211		
D 0002	G2090509	LED	GL1EG211		
D 0003	G2090509	LED	GL1EG211		
D 0004	G2090509	LED	GL1EG211		
D 0005	G2090472	LED	GL1HS111		
D 0006	G2090472	LED	GL1HS111		
P 0001	S8100213		SB-E6-9001-0		
P 0002	S8100215		SB-E6-9003-0		
R 0001	J01245561	CARBON FILM RES.	RD14TJ561	560	1/4W
R 0002	J01245561	CARBON FILM RES.	RD14TJ561	560	1/4W
R 0003	J01245561	CARBON FILM RES.	RD14TJ561	560	1/4W
R 0004	J01245561	CARBON FILM RES.	RD14TJ561	560	1/4W
R 0005	J01245561	CARBON FILM RES.	RD14TJ561	560	1/4W
R 0006	J01245561	CARBON FILM RES.	RD14TJ561	560	1/4W
S 0001	N5090060		SKHRAA		
S 0002	N5090060		SKHRAA		
S 0003	N5090060		SKHRAA		
S 0004	N5090060		SKHRAA		
S 0005	N5090060		SKHRAA		
S 0006	N5090060		SKHRAA		
S 0007	N5090060		SKHRAA		
S 0008	N5090060		SKHRAA		
S 0009	N5090060		SKHRAA		
S 0010	N5090060		SKHRAA		
S 0011	N5090060		SKHRAA		
S 0012	N5090060		SKHRAA		
S 0013	N5090060		SKHRAA		
S 0014	N5090060		SKHRAA		
S 0015	N5090060		SKHRAA		
S 0016	N5090060		SKHRAA		
S 0017	N5090060		SKHRAA		

For Service Manuals Contact
MAURITRON TECHNICAL SERVICES
 8 Cherry Tree Rd, Chinnor
 Oxon OX9 4QY
 Tel: 01844-351694 Fax: 01844-352554
 Email: enquiries@mauritron.co.uk

Key Ass'y A & B Parts Lists

ADD	CODE NO	DESCRIPTION	DEVICE	TYP VAL
		*** MAIN ASSY ***		
	S8000646		SB-B0-8100-1	
	S6000195	LED		
	S6000266		E1	
	S6000267		E2	
	S6000268		F1	
	S6000269		F2	
	S6000270		F3	
	S6000271		F4	
	S8000647		SB-G9-9011-0	
	S8000648		SB-G9-9012-0	
	S8000645		SB-F9-8000-0	

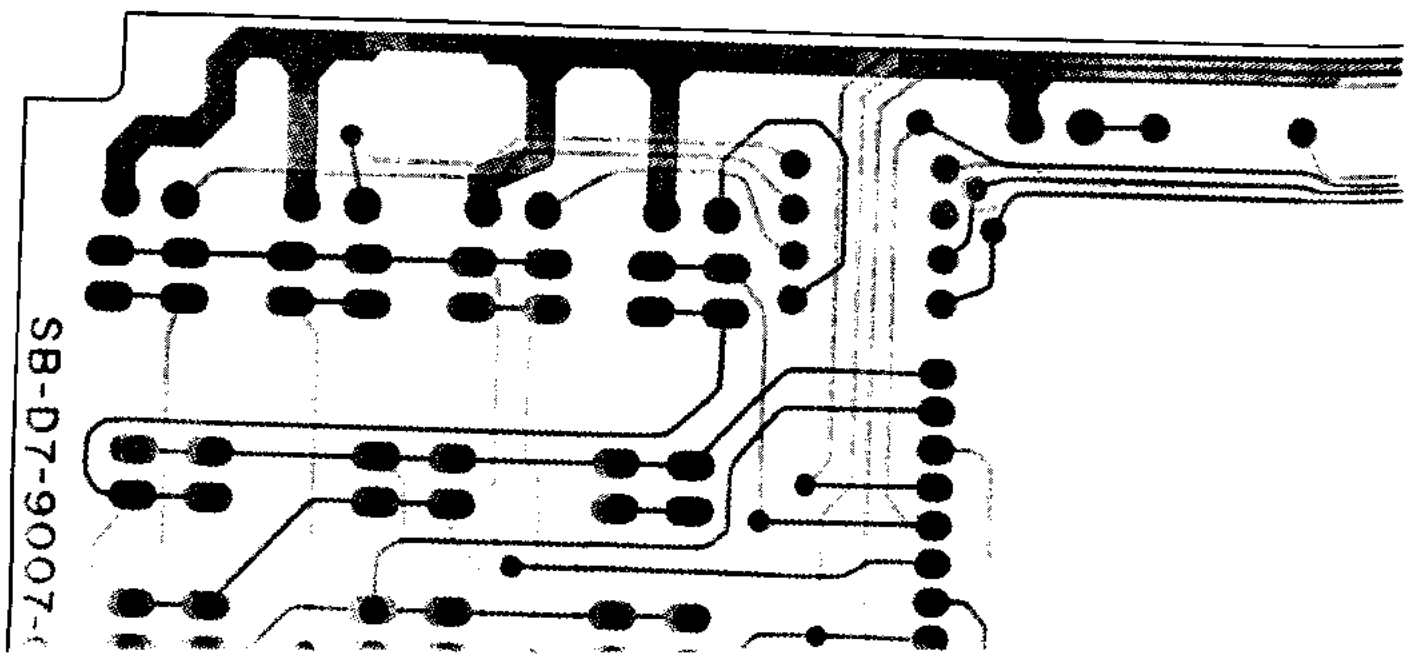
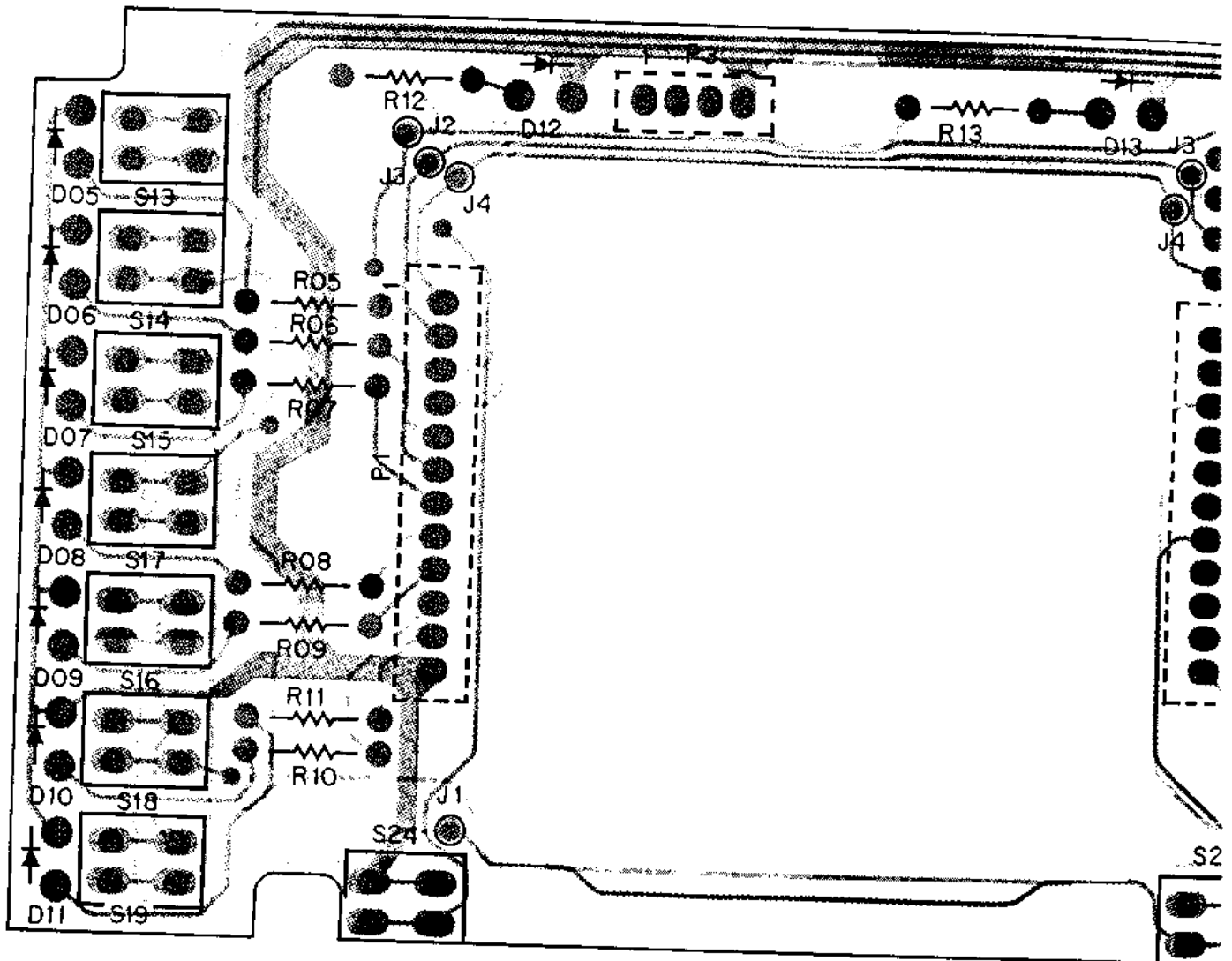

SB-D7-9007-

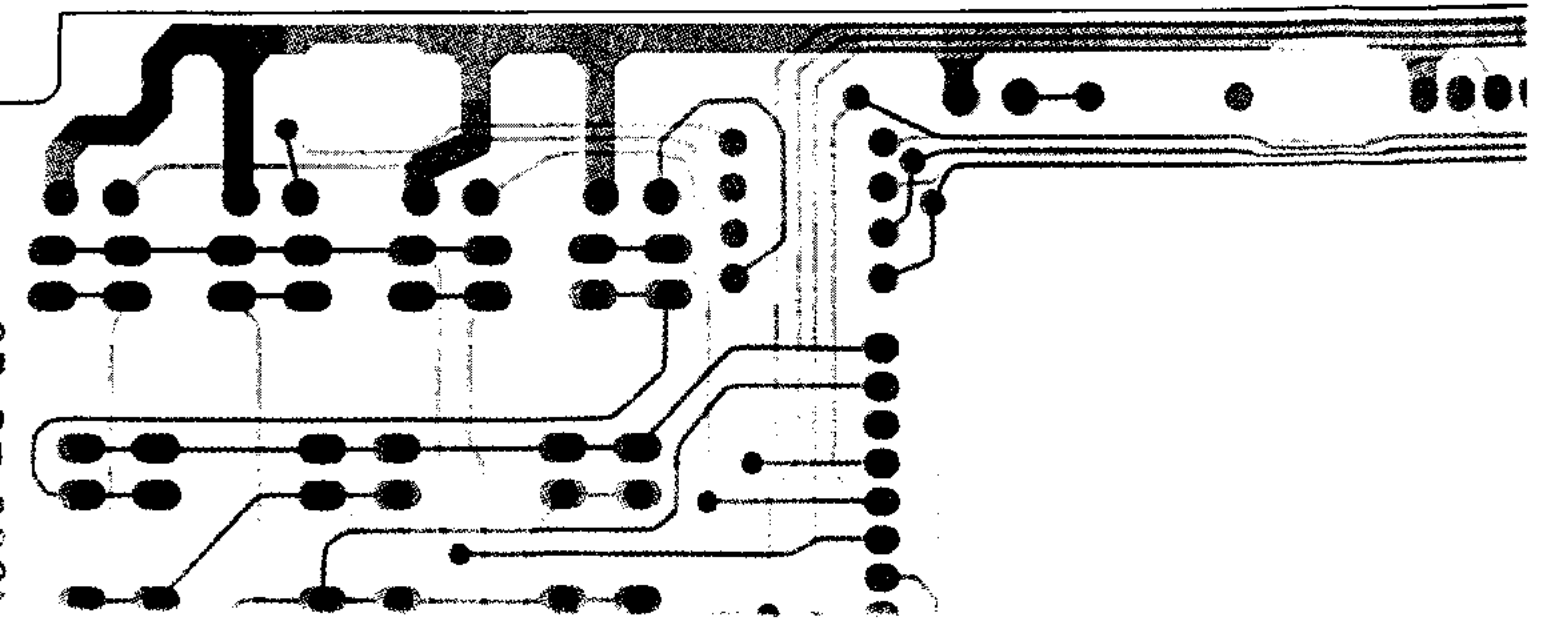
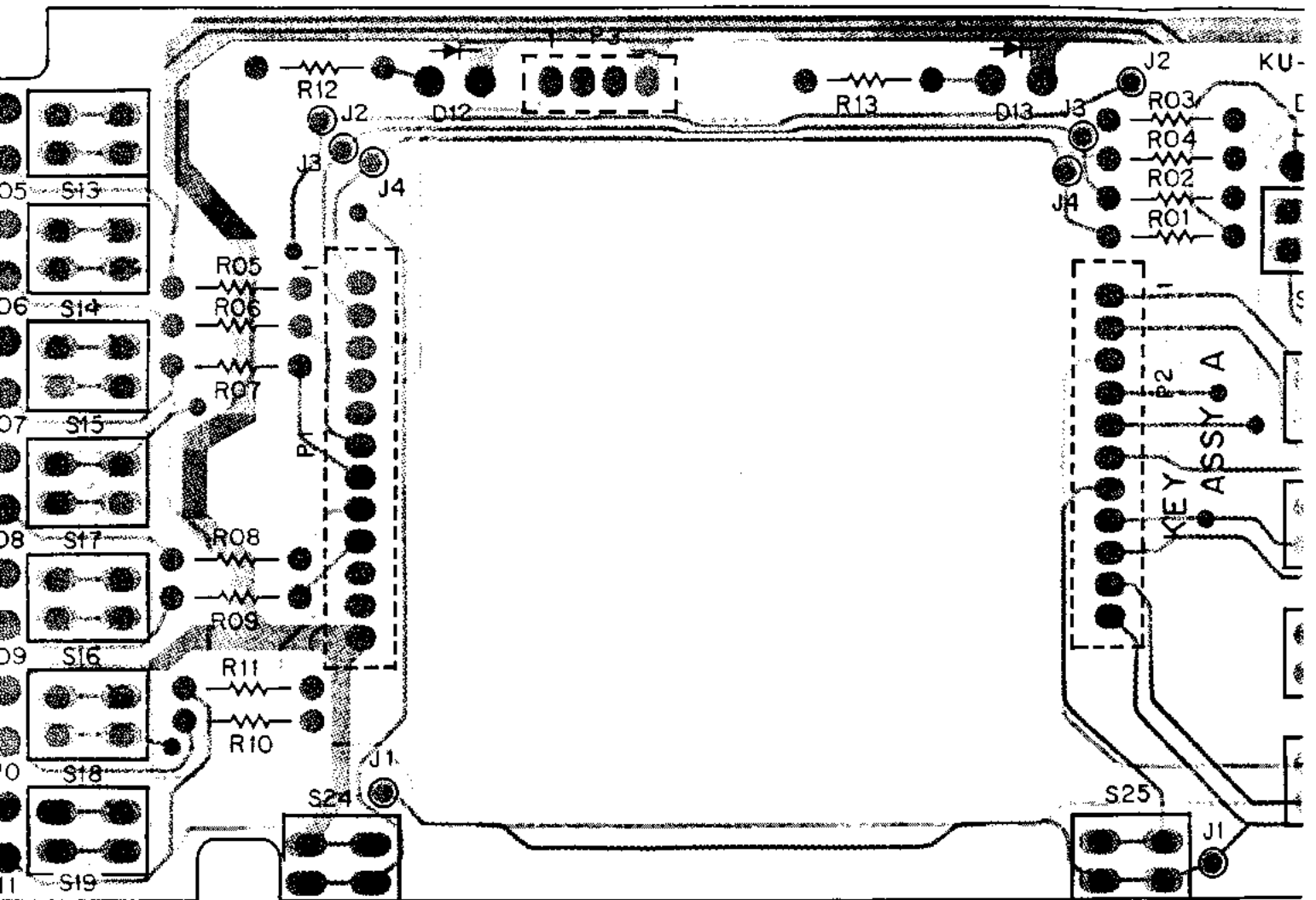

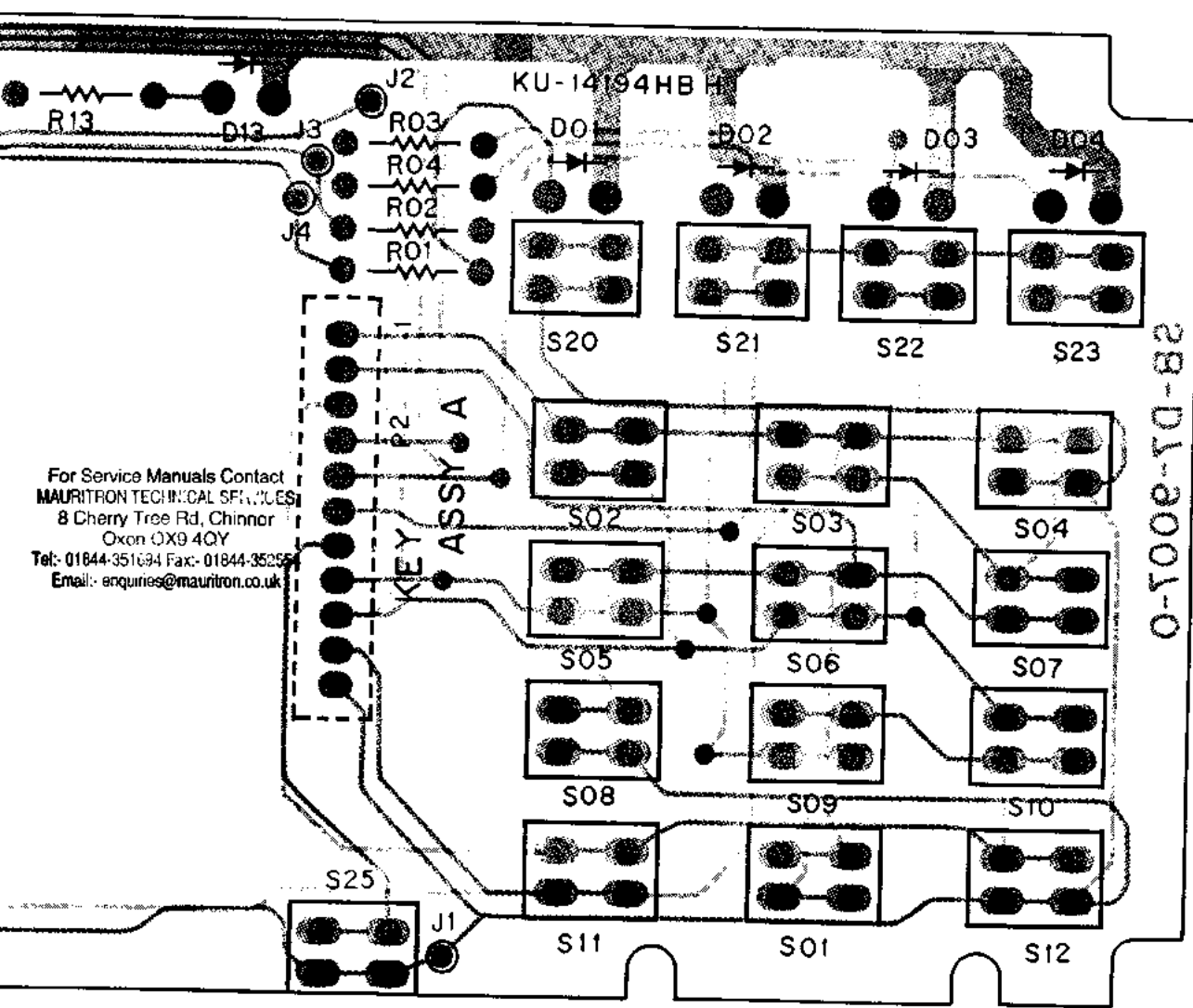

For Service Manuals Contact
MAURITRON TECHNICAL SERVICES
 8 Cherry Tree Rd, Chinnor
 Oxon OX9 4QY
 Tel: 01844-351694 Fax: 01844-35255
 Email: enquiries@mauritron.co.uk

- P1
 SB100
 0.25k
 0.5k
 2.0k
 2.4k
 LSB
 USB
 CW
 AM
 FM
 RTTY
 PKT
 GND

- P2
 SB100:
 K0 ()
 K1 ()
 K2 ()
 K3 ()
 K4 ()
 K5 ()
 K10 ()
 R0 ()
 R1 ()
 R2 ()
 R3 ()

(obverse view of "component" side)

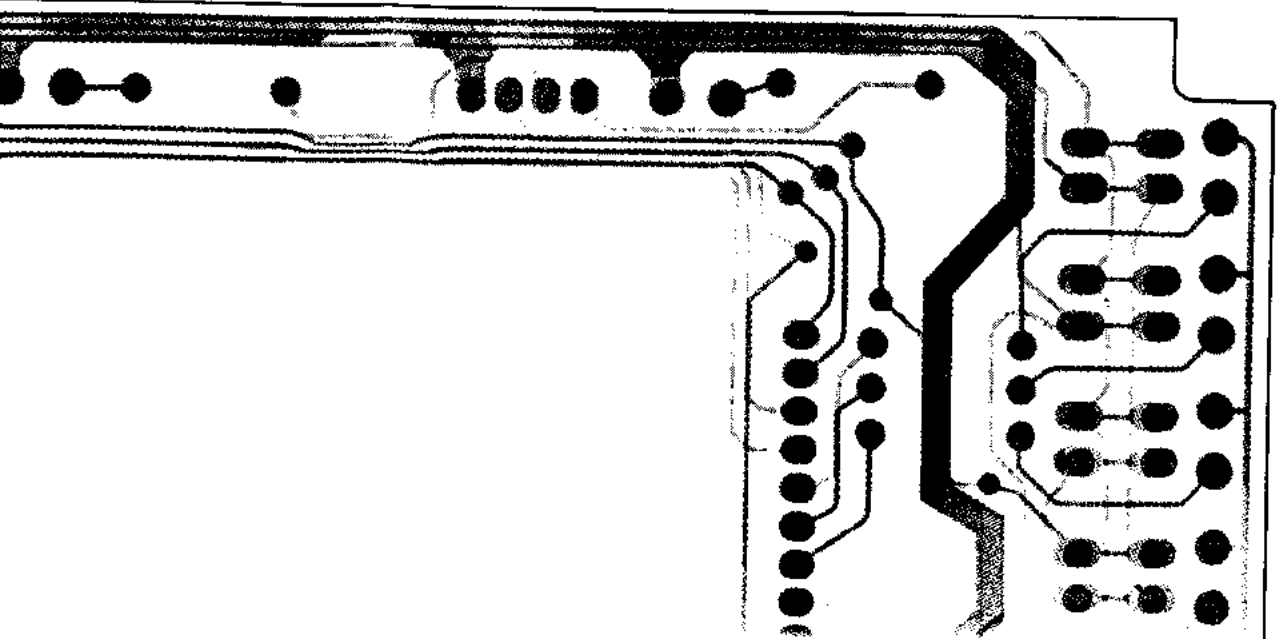

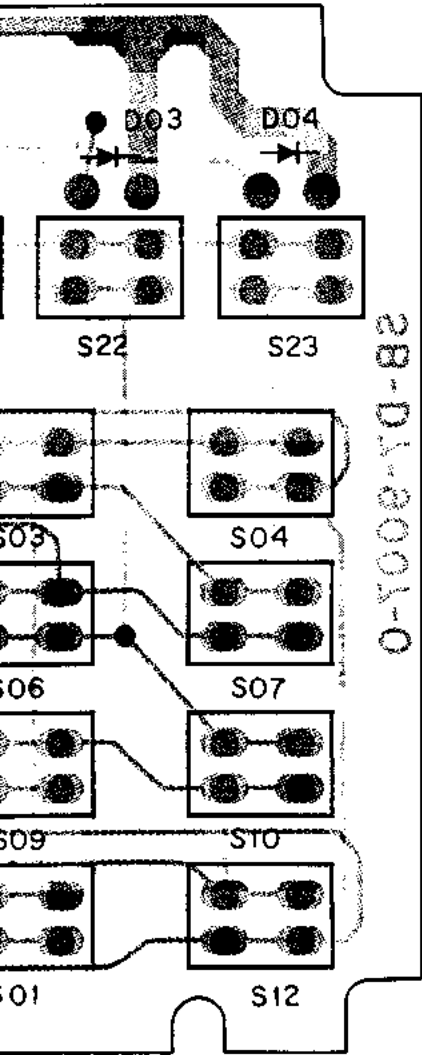

... of "component" side)

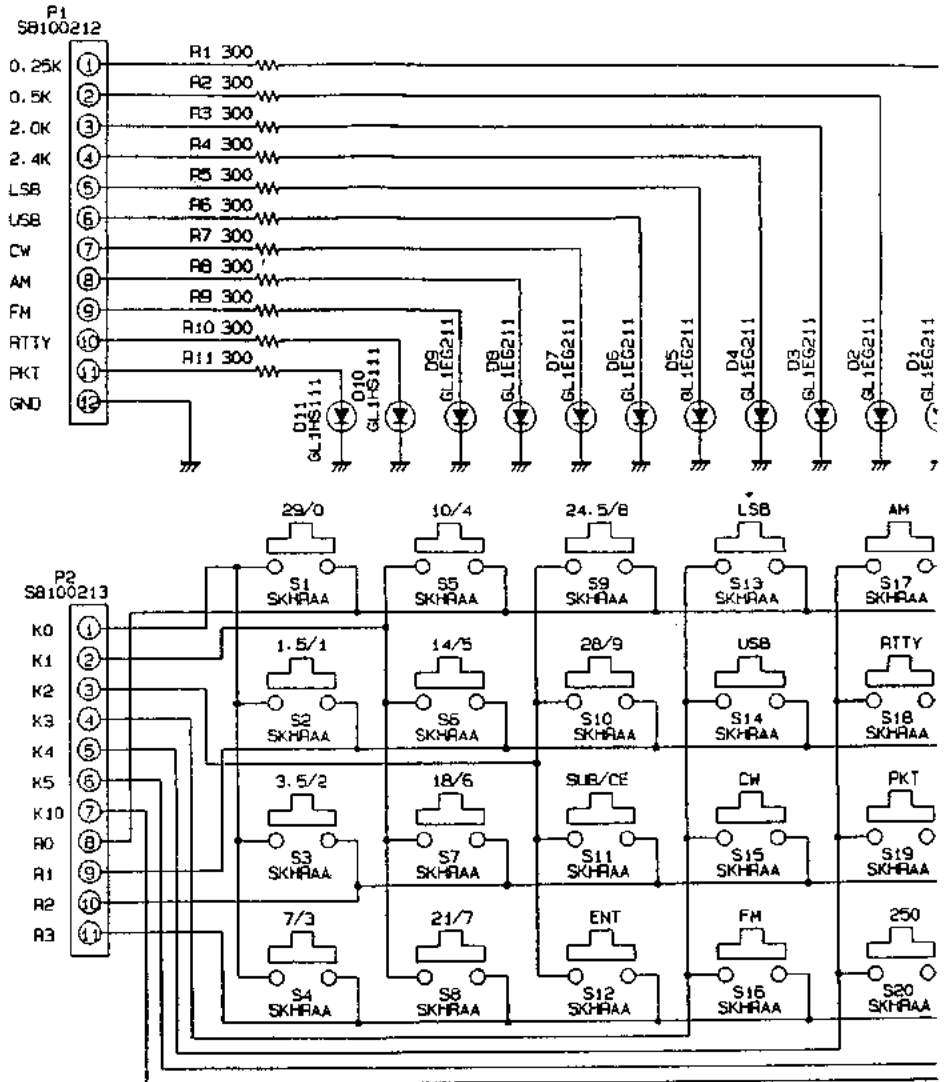
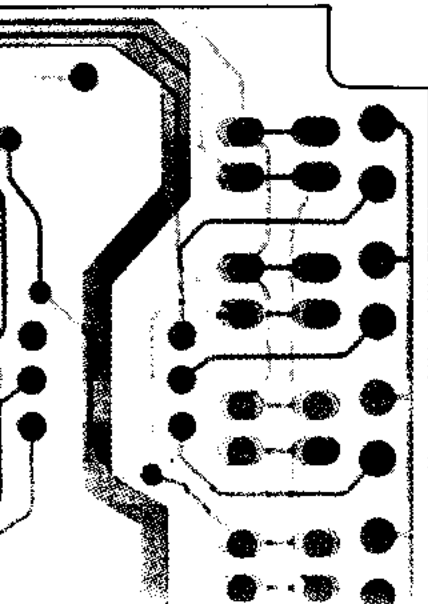

NOTE:
RESISTOR VALUES ARE IN Ω , 1/4W ;
IN PERS. OTHERWISE NOTED.

For Service Manuals Contact
MAURITRON TECHNICAL SERVICES
8 Cherry Tree Rd, Chinnor
Oxon OX9 4DY
Tel: 01844-351694 Fax: 01844-312554
Email: enquiries@mauritron.co.uk

Key Ass'y A Layout & Schematic Diagram

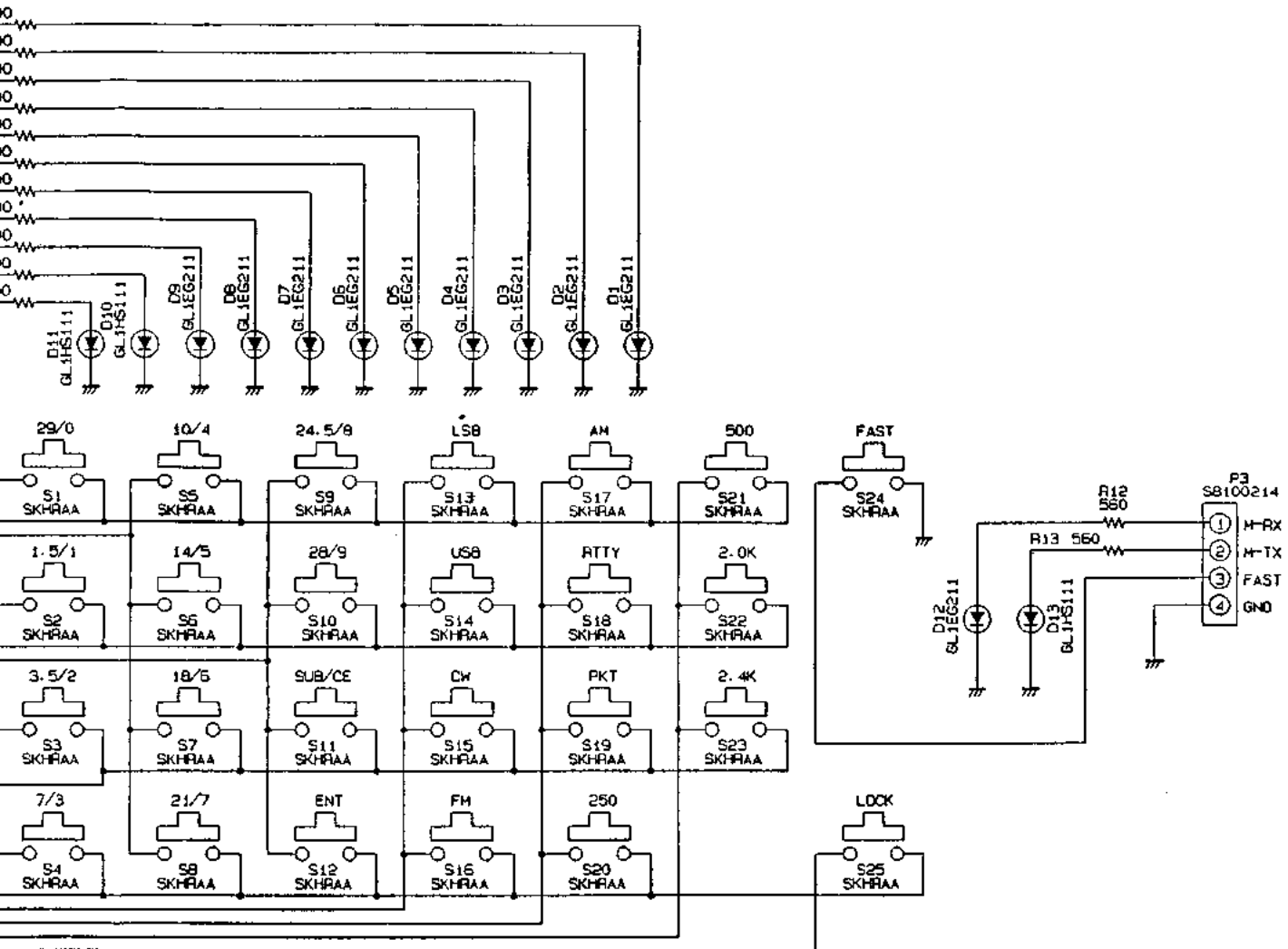

RESISTOR VALUES ARE IN Ω , 1/4W :
UNLESS OTHERWISE NOTED.

(schematic diagram)

For Service Manuals Contact
MAURITRON TECHNICAL SERVICES
 8 Cherry Tree Way, Chinnor
 Oxon OX9 4QY
 Tel: 01844-351651 Fax: 01844-352564
 Email: enquiries@mauritron.co.uk

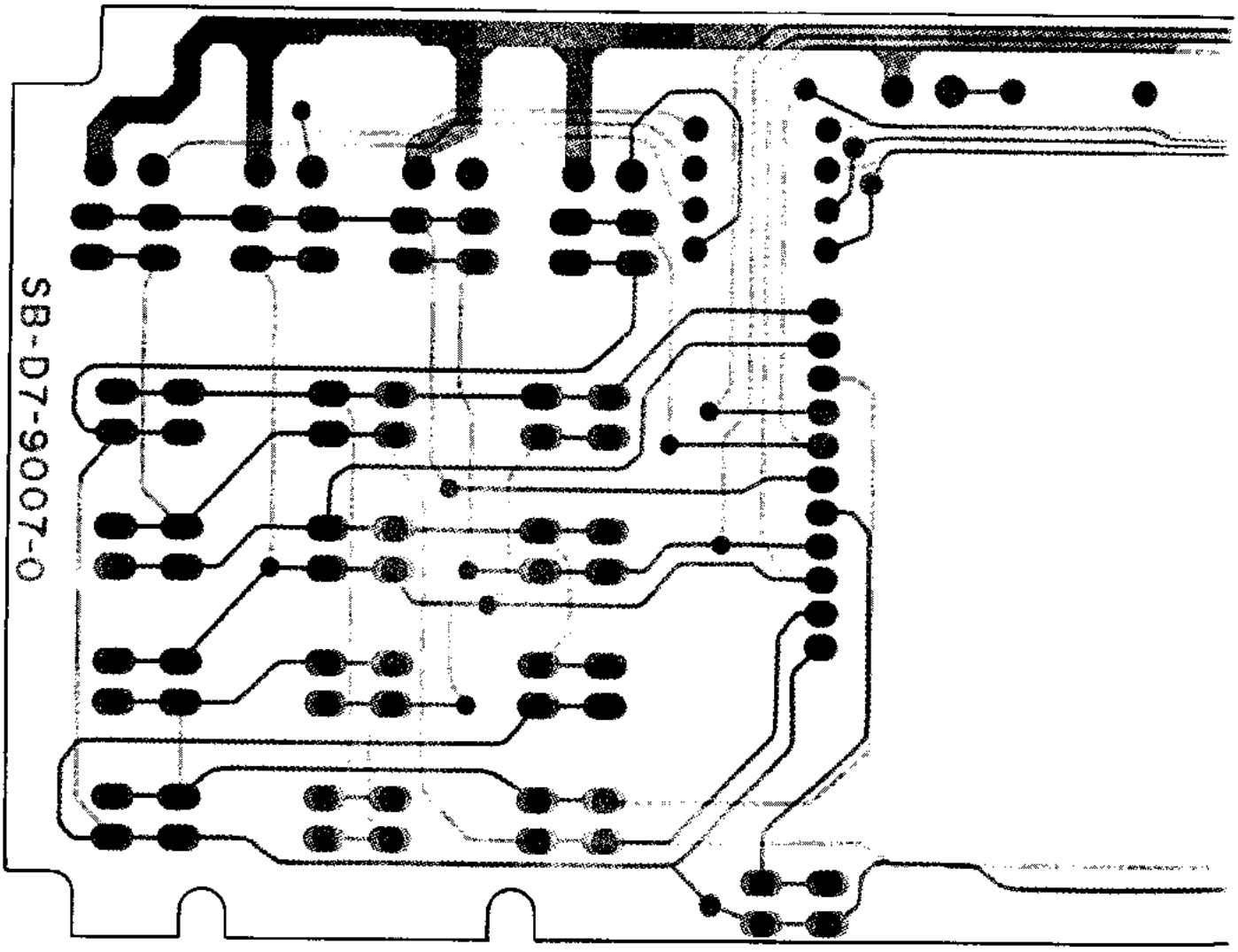
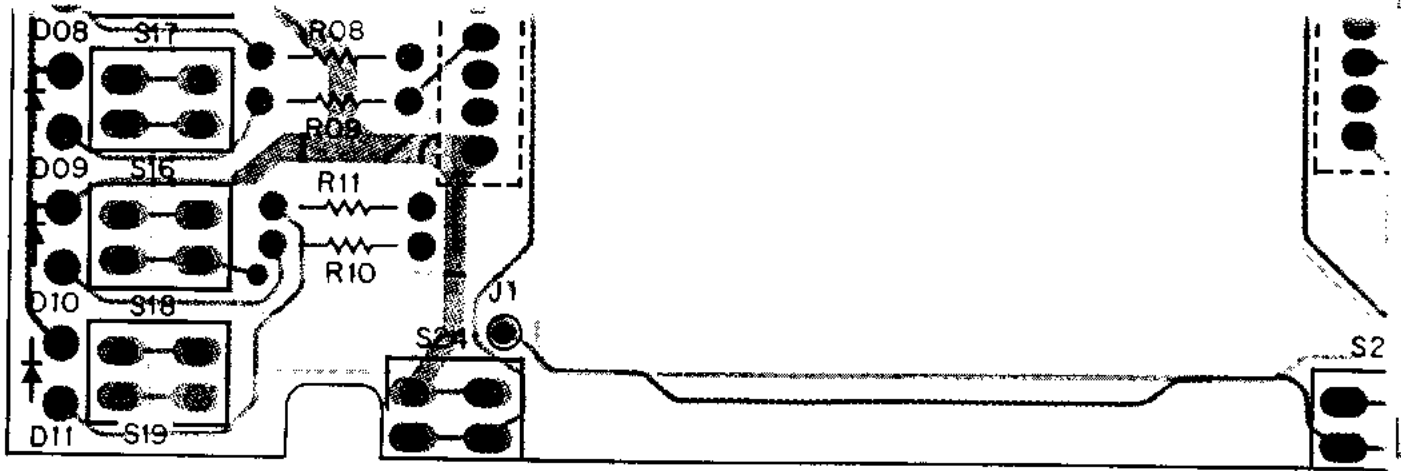

For Service Manuals Contact
MAURITRON TECHNICAL SERVICES
 8 Cherry Tree Rd, Chinnor
 Oxon OX9 4DY
 Tel: 01844-351694 Fax: 01844-352554
 Email: enquiries@mauritron.co.uk

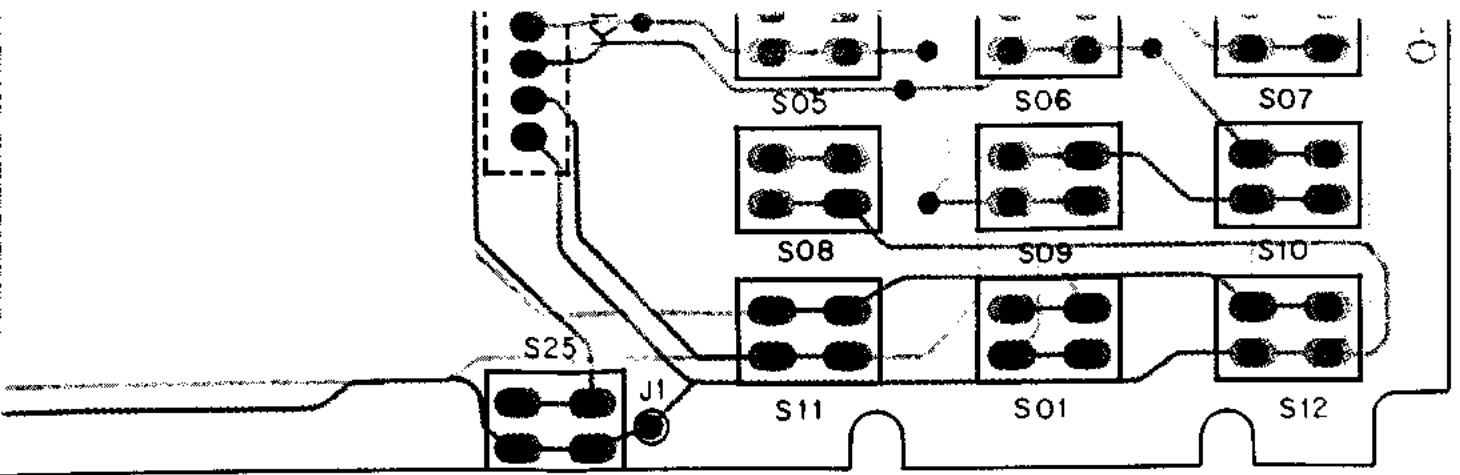

(obverse view of "component" side)

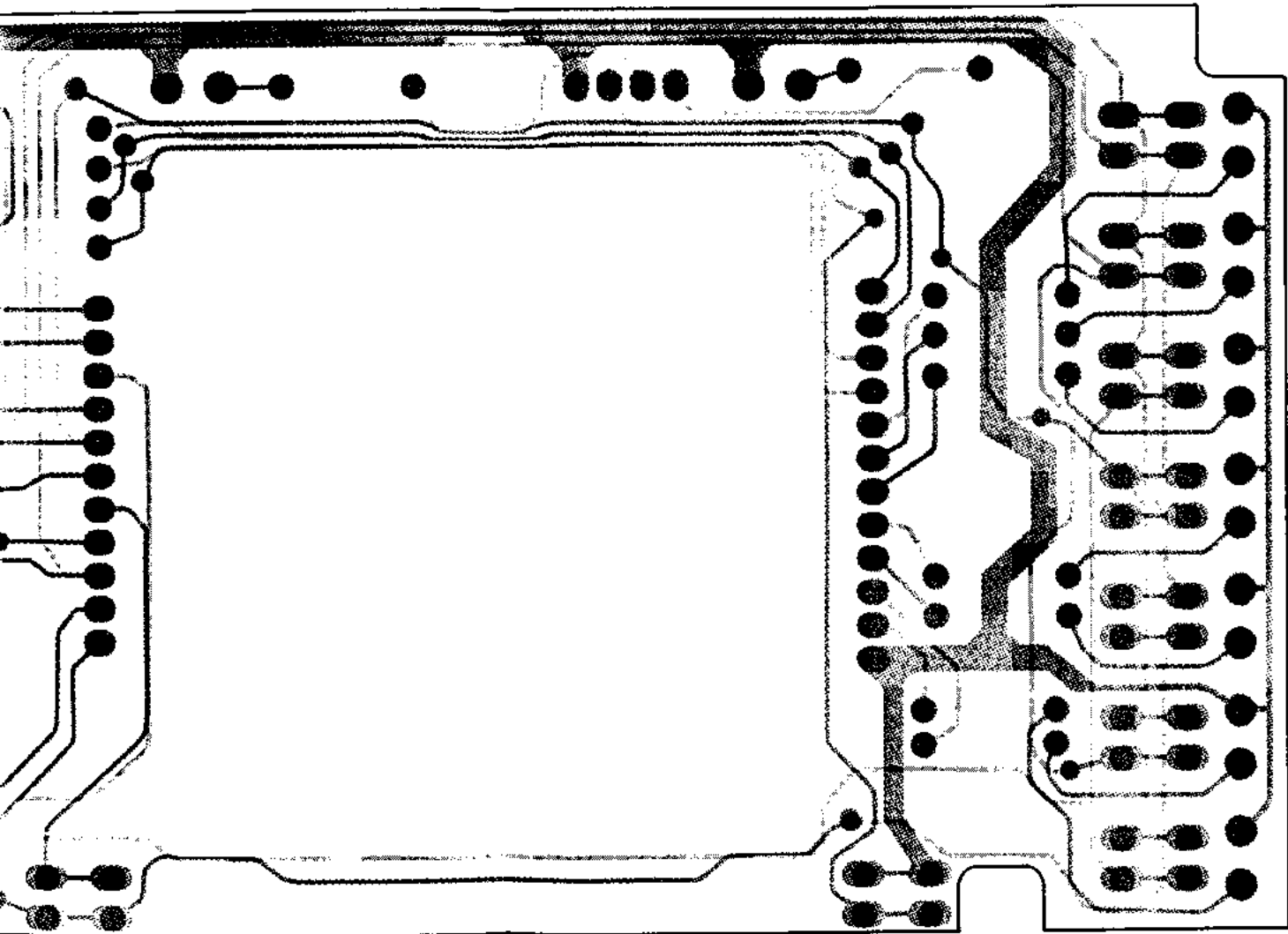

(obverse view of "solder" side)

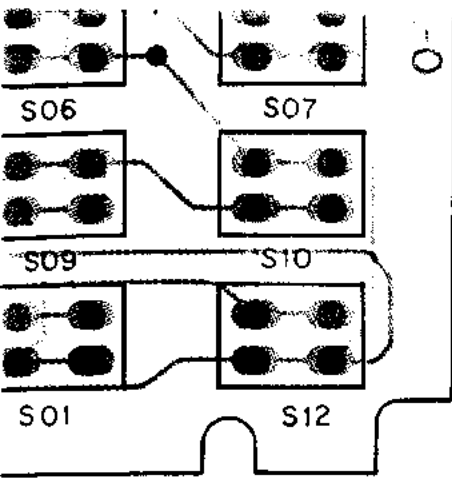

view of "component" side)

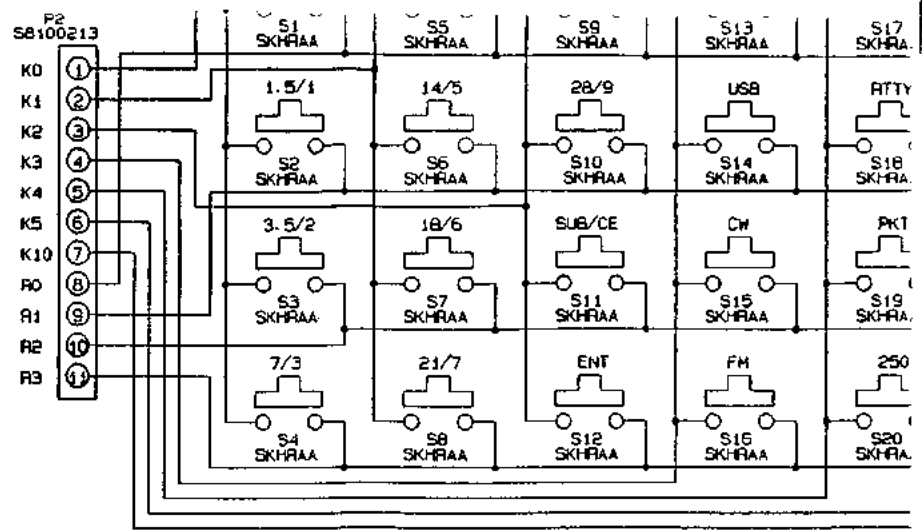

NOTE:
RESISTOR VALUES ARE IN Ω , 1/4W,
UNLESS OTHERWISE NOTED.

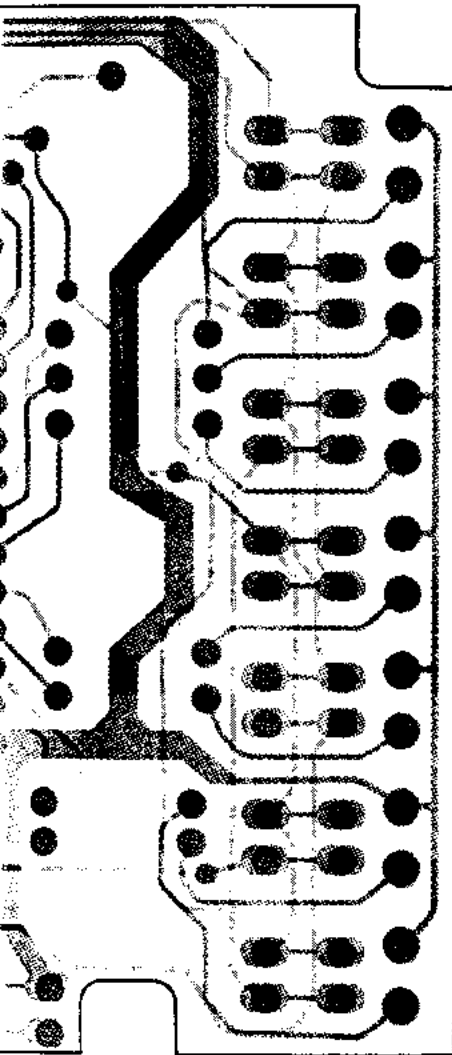

view of "solder" side)

For Service Manuals Contact
MAURITRON TECHNICAL SERVICES
8 Cherry Tree Rd, Chinnor
Oxon OX9 4QY
Tel:- 01844-351694 Fax:- 01844-352554
Email:- enquiries@mauritron.co.uk

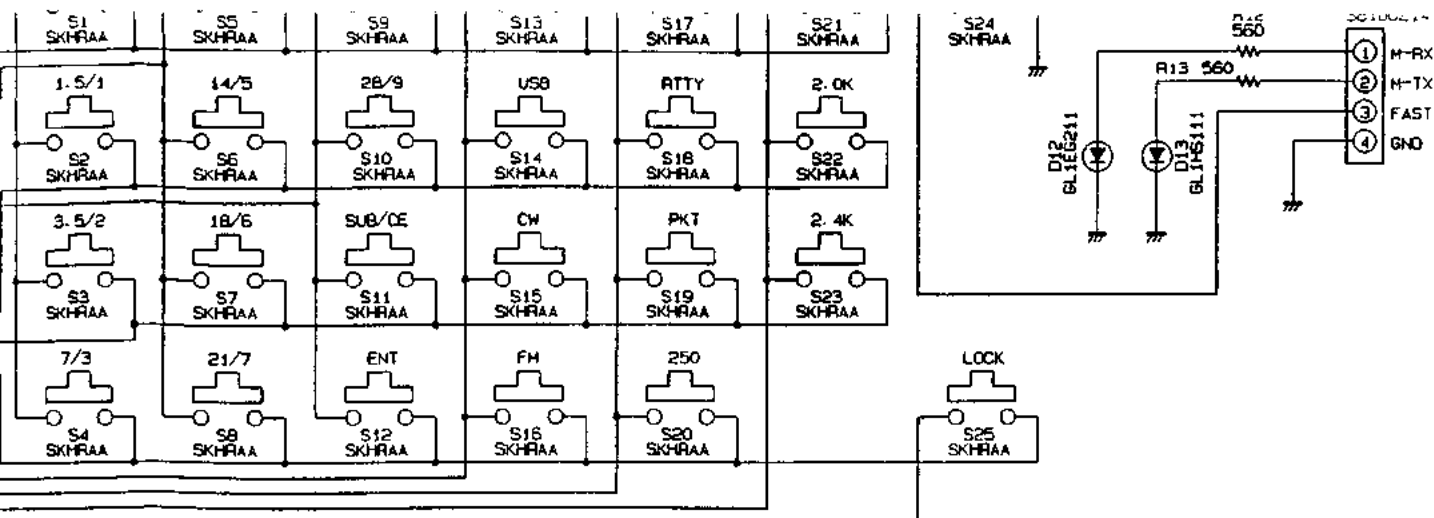

NOTE:
RESISTOR VALUES ARE IN Ω , $\frac{1}{4}W$ UNLESS OTHERWISE NOTED.

(schematic diagram)

For Service Manuals Contact
MAURITRON TECHNICAL SERVICES
 8 Cherry Tree Rd, Channon
 Oxon OX9 4DY
 Tel: 01844-351694 Fax: 01844-352554
 Email: enquiries@maurtron.co.uk

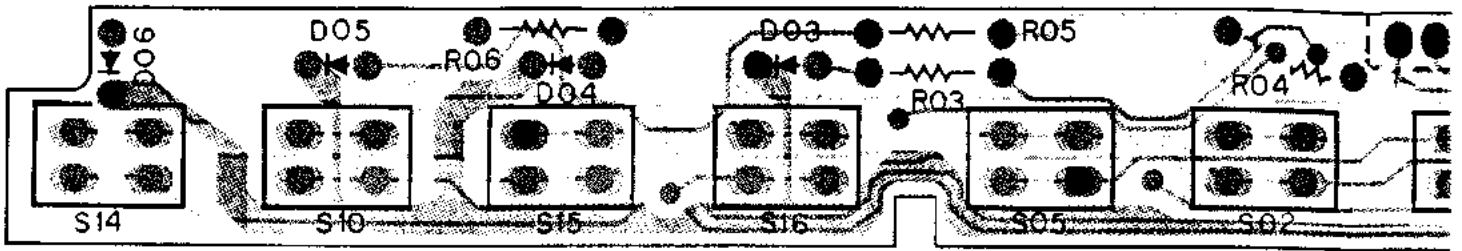

For Service Manuals Contact
 MAURITRON TECHNICAL SERVICES
 8 Cherry Tree Rd, Chinnor
 Oxon OX9 4QY
 Tel: 01844-351664 Fax: 01844-252554
 Email: enquiries@mauritron.co.uk

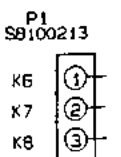
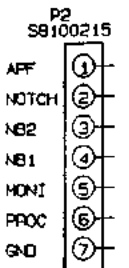
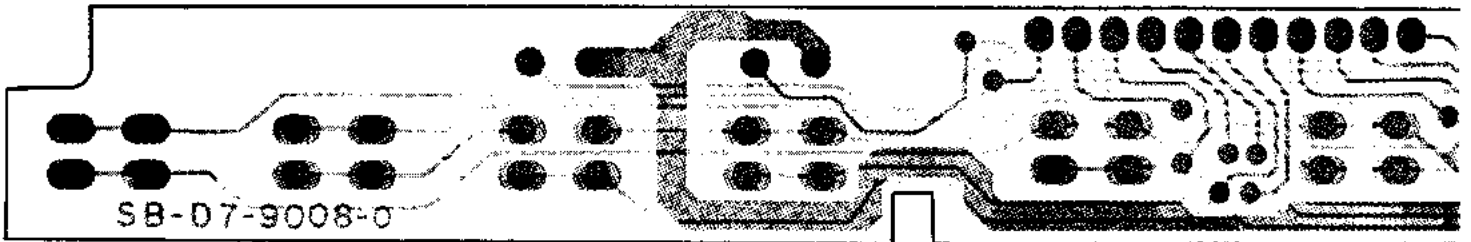

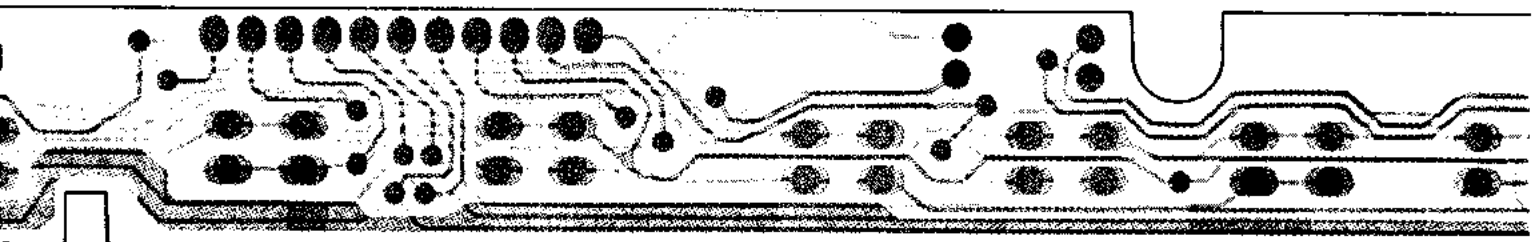
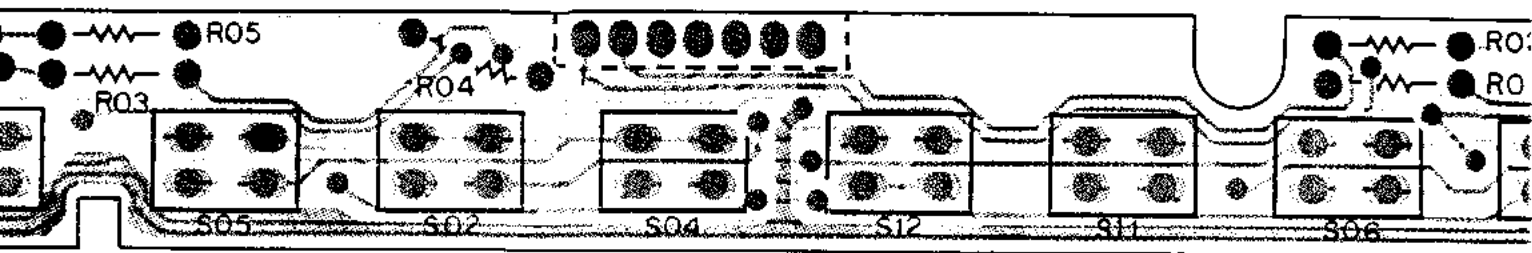

For Service Manuals Contact
 MAURITRON TECHNICAL SERVICES
 8 Cherry Tree Rd, Chinnor
 Oxon OX9 4OY
 Tel:- 01844-351894 Fax:- 01844-352554
 Email:- enquiries@mauritron.co.uk

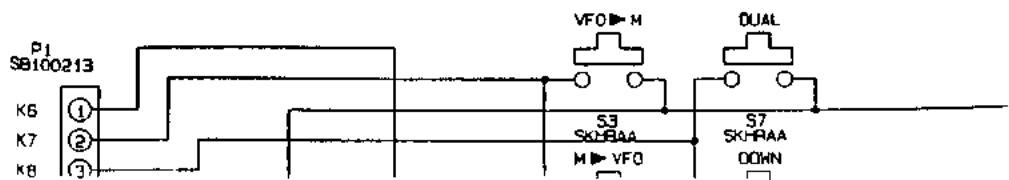
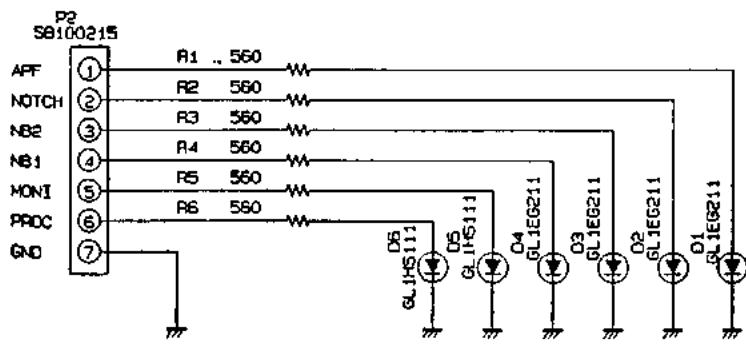

Key Ass'y B

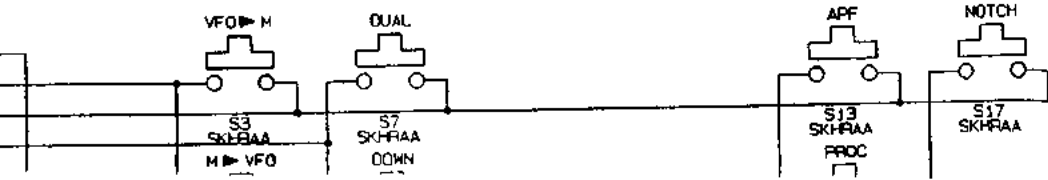
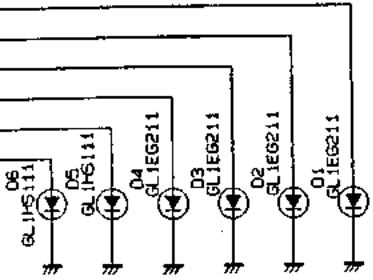
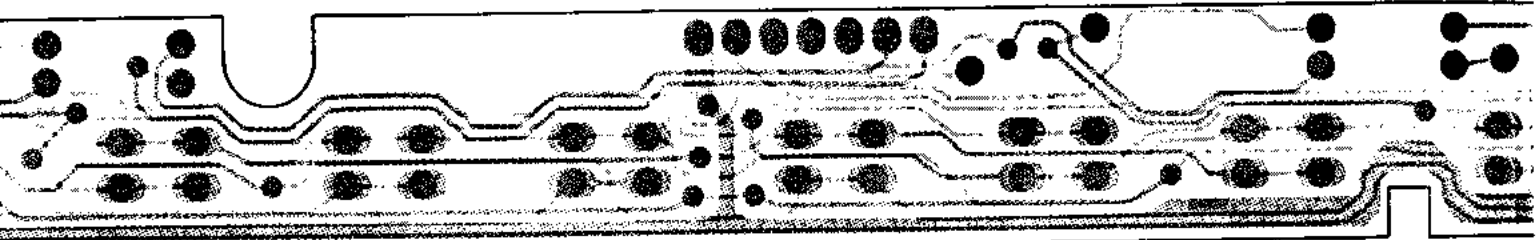
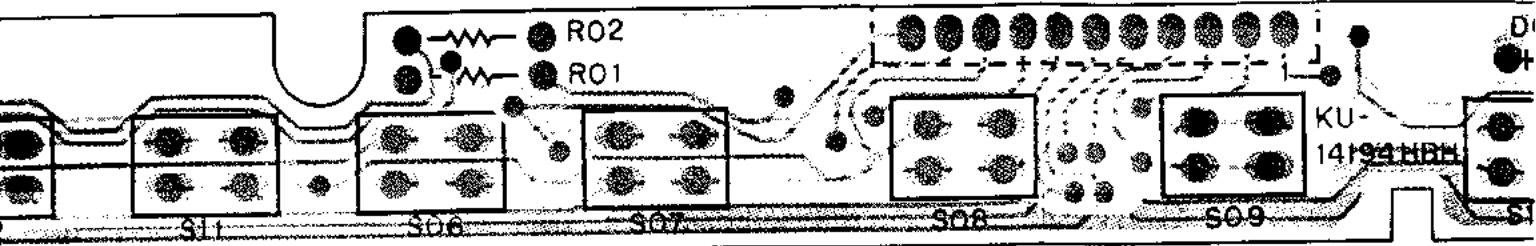

Key Ass'y B Layout & Schematic Diagram

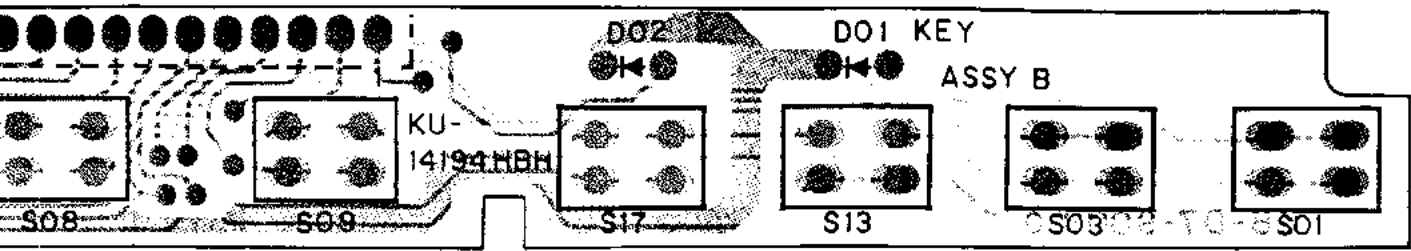

(obverse view of "component" side)

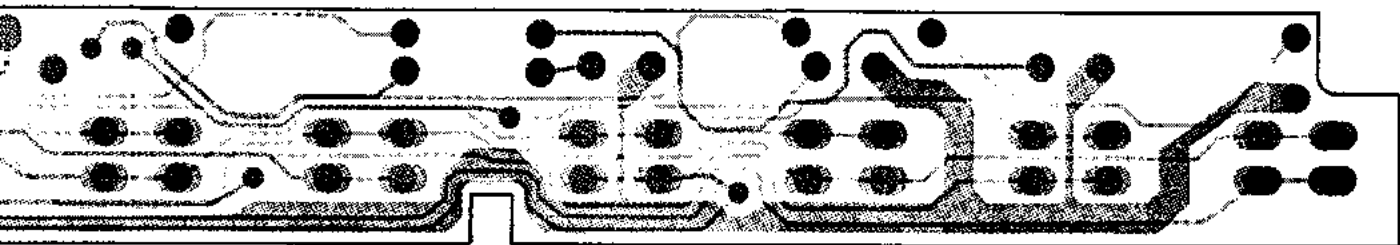

(obverse view of "solder" side)

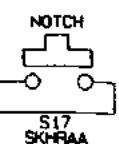



SB-D7-9008-0

For Service Manuals Contact
MAURITRON TECHNICAL SERVICES
8 Cherry Tree Rd, Chinnor
Oxon OX9 4QY
Tel: 01844-351694 Fax: 01844-352554
Email: enquiries@mauritron.co.uk

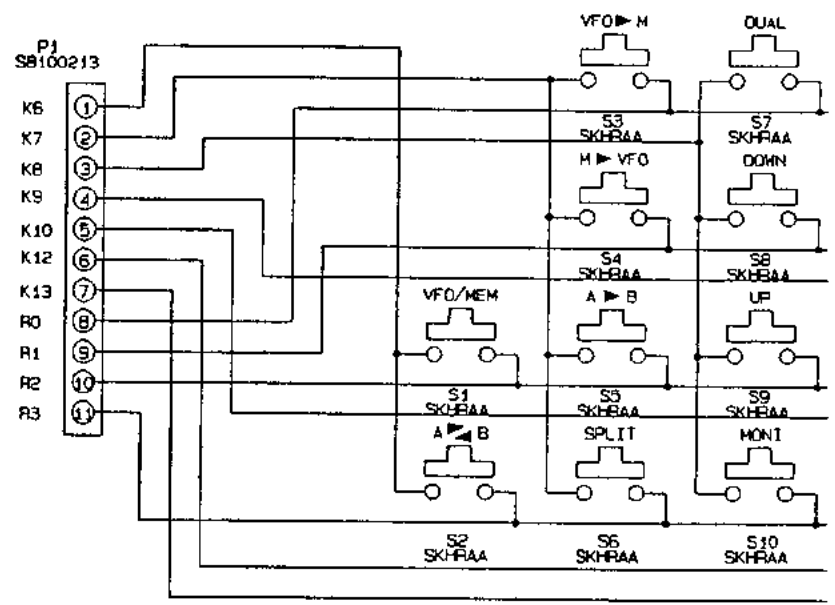
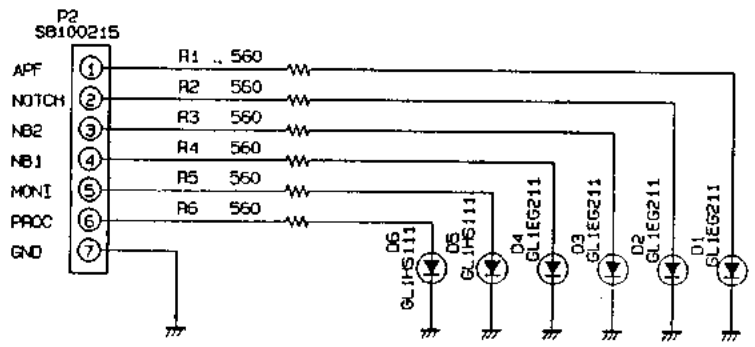
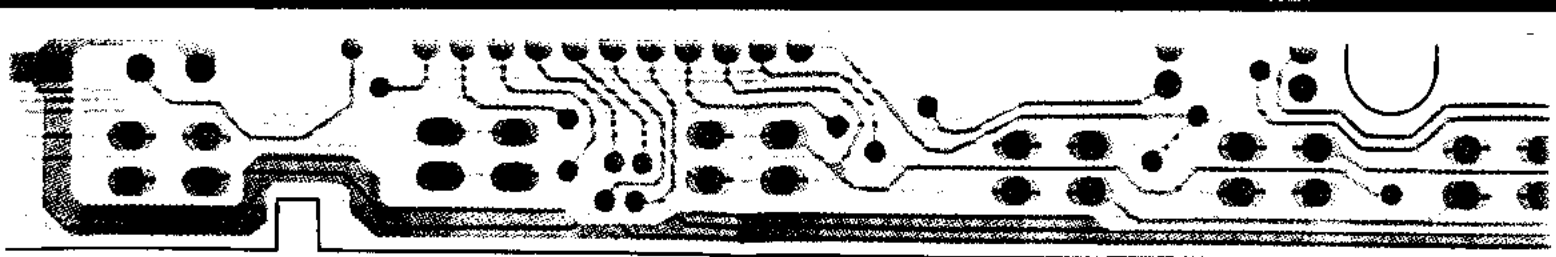

NOTE:
RESISTOR VALUES ARE IN Ω , 1/4W ;
UNLESS OTHERWISE NOTED.

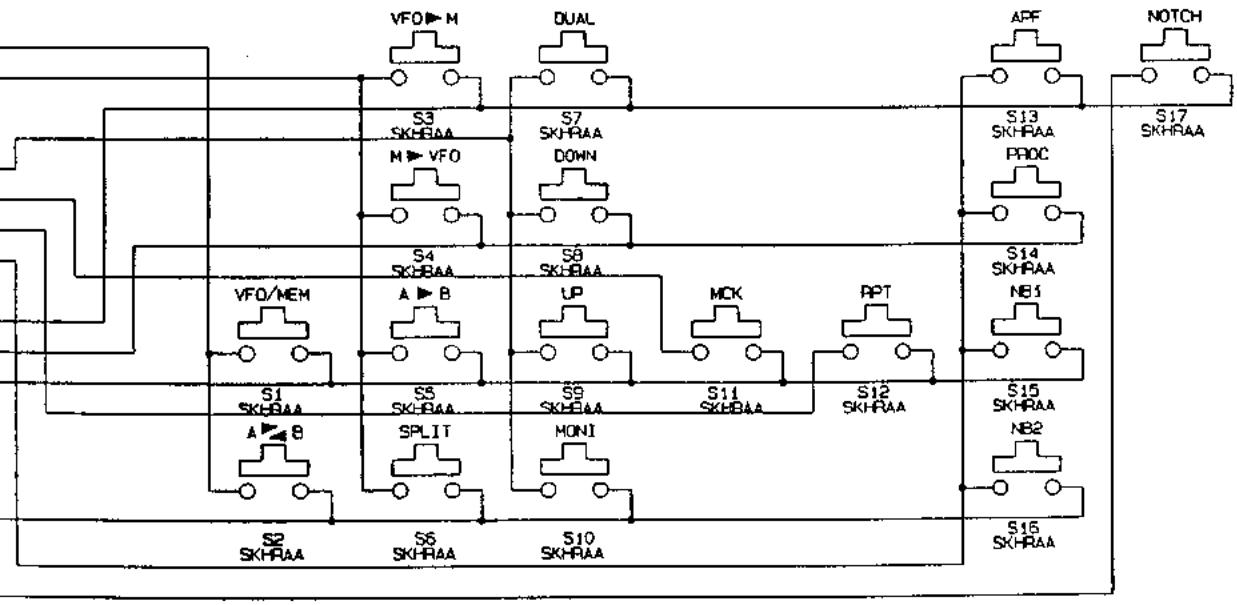
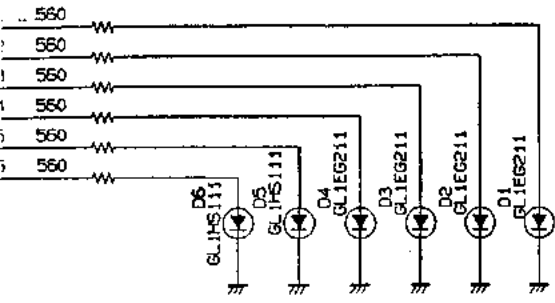
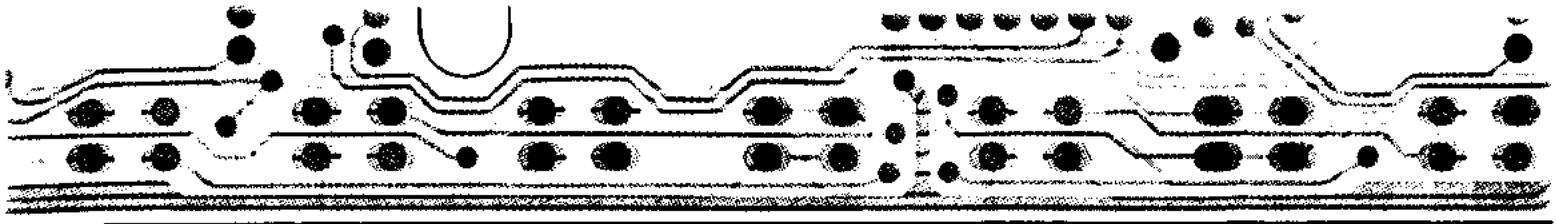

NOTE:
RESISTOR VALUES ARE IN 0.1/4W :
UNLESS OTHERWISE NOTED.

(schematic diagram)

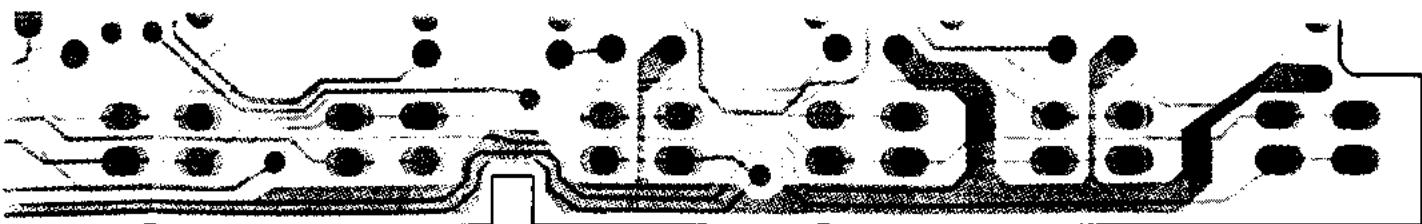

(obverse view of "solder" side)

For Service Manuals Contact
MAURITRON TECHNICAL SERVICES
8 Cherry Tree Rd, Chinnor
Oxon OX9 4DY
Tel: 01844-391111 Fax: 01444-352554
Email: enquiries@mauritron.co.uk

NOTCH



S17
SKHRAA

BPF-1 Packaging

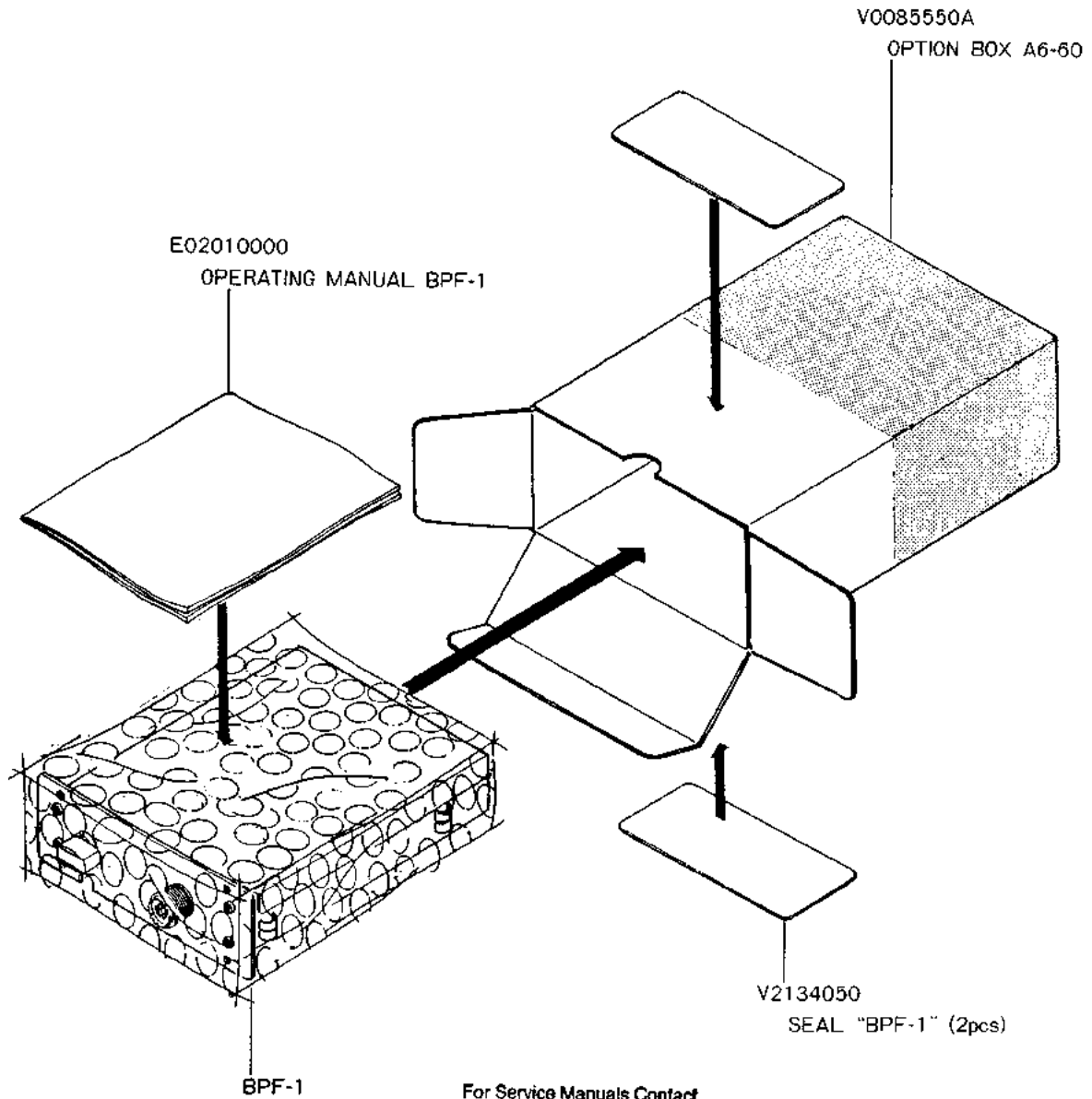

For Service Manuals Contact
MAURITRON TECHNICAL SERVICES
8 Cherry Tree Rd, Chinnor
Oxon OX9 4QY
Tel:- 01844-351694 Fax:- 01844-352554
Email:- enquiries@mauritron.co.uk

BPF-1 Exploded View

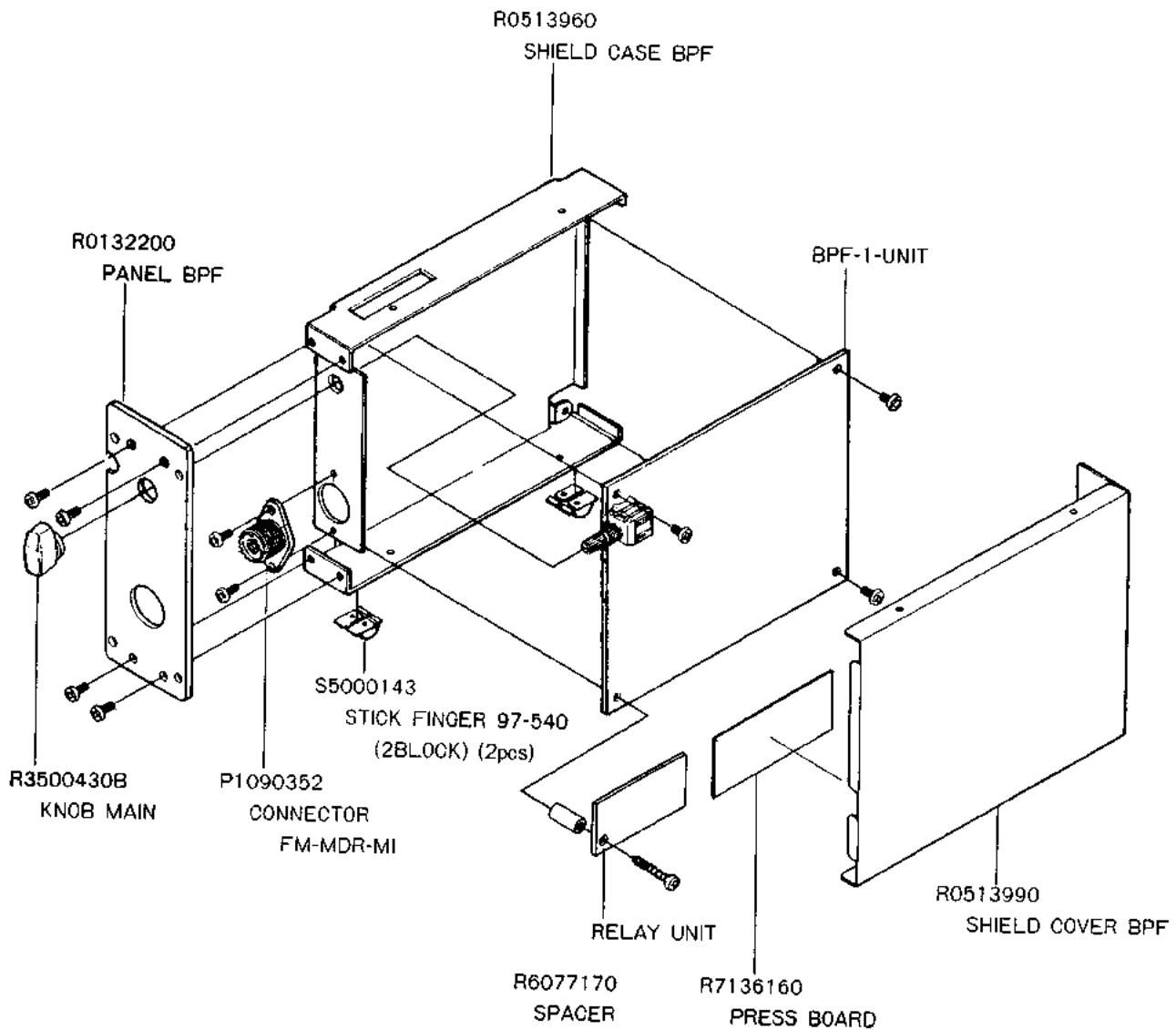

For Service Manuals Contact
MAURITRON TECHNICAL SERVICES
8 Cherry Tree Rd, Chinnor
Oxon OX9 4QY
Tel: 01844-351654 Fax: 01844-352554
Email: enquiries@mauritron.co.uk

BPF-1 Parts List

ADD	CODE NO	DESCRIPTION	DEVICE	TYP	VAL
** UNIT NAME : BPF-1-UNIT					
C 9801	K26171025	CERAMIC CAP.	DD104-979SL680J50	68pF	50V SL
C 9802	K26171013	CERAMIC CAP.	DD104-979SL220J50	22pF	50V SL
C 9803	K26171033	CERAMIC CAP.	DD106-979SL151J50	150pF	50V SL
C 9804	K26171001	CERAMIC CAP.	DD104-979SL060D50	6pF	50V SL
C 9805	K26171025	CERAMIC CAP.	DD104-979SL680J50	68pF	50V SL
C 9806	K26170726	CERAMIC CAP.	DD306-979F473Z50	0.047uF	50V F
C 9807	K46170021	AL. ELECTRO. CAP.	50V100M5X11TR5	10uF	50V
C 9808	K26170703	CERAMIC CAP.	UAU04X152K7L36VC	0.0015	50V X
C 9809	K26170706	CERAMIC CAP.	UAU05X272K7L36VC	0.0027	50V X
C 9810	K26170706	CERAMIC CAP.	UAU05X272K7L36VC	0.0027	50V X
C 9811	K26170703	CERAMIC CAP.	UAU04X152K7L36VC	0.0015	50V X
C 9812	K26170726	CERAMIC CAP.	DD306-979F473Z50	0.047uF	50V F
C 9813	K46170021	AL. ELECTRO. CAP.	50V100M5X11TR5	10uF	50V
C 9814	K26171045	CERAMIC CAP.	DD109-979SL471J50	470pF	50V SL
C 9815	K26170726	CERAMIC CAP.	DD306-979F473Z50	0.047uF	50V F
C 9816	K26170702	CERAMIC CAP.	UAU04X122K7L36VC	0.0012	50V X
C 9817	K26171048	CERAMIC CAP.	DD110-979SL621J50	620p	50V SL
C 9818	K26171039	CERAMIC CAP.	DD107-979SL271J50	270pF	50V SL
C 9819	K26170702	CERAMIC CAP.	UAU04X122K7L36VC	0.0012	50V X
C 9820	K26170726	CERAMIC CAP.	DD306-979F473Z50	0.047uF	50V F
C 9821	K00175511	CERAMIC CAP.	DD109SL511J50	510p	50V SL
C 9822	K46170021	AL. ELECTRO. CAP.	50V100M5X11TR5	10uF	50V
C 9823	K26171039	CERAMIC CAP.	DD107-979SL271J50	270pF	50V SL
C 9824	K26171039	CERAMIC CAP.	DD107-979SL271J50	270pF	50V SL
C 9826	K46170021	AL. ELECTRO. CAP.	50V100M5X11TR5	10uF	50V
C 9827	K26170726	CERAMIC CAP.	DD306-979F473Z50	0.047uF	50V F
C 9828	K26171047	CERAMIC CAP.	DD109-979SL561J50	560pF	50V SL
C 9829	K26170726	CERAMIC CAP.	DD306-979F473Z50	0.047uF	50V F
C 9830	K00179019	CERAMIC CAP.	DD106SL201J50	200p	50V SL
C 9831	K26171048	CERAMIC CAP.	DD110-979SL621J50	620p	50V SL
C 9832	K00179019	CERAMIC CAP.	DD106SL201J50	200p	50V SL
C 9833	K26170726	CERAMIC CAP.	DD306-979F473Z50	0.047uF	50V F
C 9834	K00175511	CERAMIC CAP.	DD109SL511J50	510p	50V SL
C 9835	K46170021	AL. ELECTRO. CAP.	50V100M5X11TR5	10uF	50V
C 9836	K26171043	CERAMIC CAP.	DD108-979SL391J50	390pF	50V SL
C 9837	K26170726	CERAMIC CAP.	DD306-979F473Z50	0.047uF	50V F
C 9838	K00179015	CERAMIC CAP.	DD105SL111J50	110p	50V SL
C 9839	K26171045	CERAMIC CAP.	DD109-979SL471J50	470pF	50V SL
C 9840	K00179021	CERAMIC CAP.	DD107SL301J50	300p	50V SL
C 9841	K00179015	CERAMIC CAP.	DD105SL111J50	110p	50V SL
C 9842	K26170726	CERAMIC CAP.	DD306-979F473Z50	0.047uF	50V F
C 9843	K26171043	CERAMIC CAP.	DD108-979SL391J50	390pF	50V SL
C 9844	K46170021	AL. ELECTRO. CAP.	50V100M5X11TR5	10uF	50V
C 9845	K26171035	CERAMIC CAP.	DD106-979SL181J50	180pF	50V SL
C 9846	K26170657	CERAMIC CAP.	DD106-979F103Z50	0.01uF	50V F
C 9847	K00179013	CERAMIC CAP.	DD105SL910J50	91p	50V SL
C 9848	K26171043	CERAMIC CAP.	DD108-979SL391J50	390pF	50V SL
C 9849	K00179013	CERAMIC CAP.	DD105SL910J50	91p	50V SL
C 9850	K26170657	CERAMIC CAP.	DD106-979F103Z50	0.01uF	50V F
C 9851	K26171035	CERAMIC CAP.	DD106-979SL181J50	180pF	50V SL
C 9852	K46170021	AL. ELECTRO. CAP.	50V100M5X11TR5	10uF	50V
C 9853	K00179020	CERAMIC CAP.	DD107SL241J50	240p	50V SL
C 9854	K26170657	CERAMIC CAP.	DD106-979F103Z50	0.01uF	50V F
C 9855	K00179008	CERAMIC CAP.	DD104SL360J50	36p	50V SL
C 9857	K26171043	CERAMIC CAP.	DD108-979SL391J50	390pF	50V SL
C 9858	K00179008	CERAMIC CAP.	DD104SL360J50	36p	50V SL
C 9859	K26170657	CERAMIC CAP.	DD106-979F103Z50	0.01uF	50V F
C 9860	K00179020	CERAMIC CAP.	DD107SL241J50	240p	50V SL
C 9861	K46170021	AL. ELECTRO. CAP.	50V100M5X11TR5	10uF	50V
C 9862	K26171033	CERAMIC CAP.	DD106-979SL151J50	150pF	50V SL
C 9863	K26170657	CERAMIC CAP.	DD106-979F103Z50	0.01uF	50V F
C 9864	K26171017	CERAMIC CAP.	DD104-979SL330J50	33pF	50V SL
C 9865	K00179022	CERAMIC CAP.	DD108SL361J50	360p	50V SL
C 9866	K26171017	CERAMIC CAP.	DD104-979SL330J50	33pF	50V SL
C 9867	K26170657	CERAMIC CAP.	DD106-979F103Z50	0.01uF	50V F
C 9868	K00179018	CERAMIC CAP.	DD106SL161J50	160p	50V SL
C 9869	K46170021	AL. ELECTRO. CAP.	50V100M5X11TR5	10uF	50V
C 9870	K26171033	CERAMIC CAP.	DD106-979SL151J50	150pF	50V SL
C 9871	K26170657	CERAMIC CAP.	DD106-979F103Z50	0.01uF	50V F
C 9872	K26171013	CERAMIC CAP.	DD104-979SL220J50	22pF	50V SL
C 9873	K00179022	CERAMIC CAP.	DD108SL361J50	360p	50V SL
C 9874	K26171013	CERAMIC CAP.	DD104-979SL220J50	22pF	50V SL
C 9875	K26170657	CERAMIC CAP.	DD106-979F103Z50	0.01uF	50V F
C 9876	K00179018	CERAMIC CAP.	DD106SL161J50	160p	50V SL
C 9877	K46170021	AL. ELECTRO. CAP.	50V100M5X11TR5	10uF	50V
C 9878	K26171031	CERAMIC CAP.	DD105-979SL121J50	120pF	50V SL
C 9879	K26170657	CERAMIC CAP.	DD106-979F103Z50	0.01uF	50V F
C 9880	K26171011	CERAMIC CAP.	DD104-979SL180J50	18pF	50V SL
C 9881	K26171039	CERAMIC CAP.	DD107-979SL271J50	270pF	50V SL
C 9882	K26171011	CERAMIC CAP.	DD104-979SL180J50	18pF	50V SL
C 9883	K26170657	CERAMIC CAP.	DD106-979F103Z50	0.01uF	50V F
C 9884	K00179017	CERAMIC CAP.	DD105-257SL131J50	130p	50V SL

BPF-1 Parts List

ADD	CODE NO	DESCRIPTION	DEVICE	TYP	VAL
C 9885	K46170021	AL. ELECTRO. CAP.	50V100M5X11TR5	10uF	50V
C 9886	K26171025	CERAMIC CAP.	DD104-979SL680J50	68pF	50V SL
C 9887	K26170657	CERAMIC CAP.	DD106-979F103Z50	0.01uF	50V F
C 9888	K00179005	CERAMIC CAP.	DD104SL200J50	20p	50V SL
C 9889	K26171033	CERAMIC CAP.	DD106-979SL151J50	150pF	50V SL
C 9890	K00179005	CERAMIC CAP.	DD104SL200J50	20p	50V SL
C 9891	K26170657	CERAMIC CAP.	DD106-979F103Z50	0.01uF	50V F
C 9892	K26171025	CERAMIC CAP.	DD104-979SL680J50	68pF	50V SL
C 9893	K46170021	AL. ELECTRO. CAP.	50V100M5X11TR5	10uF	50V
C 9894	K26171019	CERAMIC CAP.	DD104-979SL390J50	39pF	50V SL
C 9895	K26170657	CERAMIC CAP.	DD106-979F103Z50	0.01uF	50V F
C 9896	K26171007	CERAMIC CAP.	DD104-979SL120J50	12pF	50V SL
C 9897	K26171029	CERAMIC CAP.	DD105-979SL101J50	100pF	50V SL
C 9898	K26171007	CERAMIC CAP.	DD104-979SL120J50	12pF	50V SL
C 9899	K26170657	CERAMIC CAP.	DD106-979F103Z50	0.01uF	50V F
C 9900	K26171019	CERAMIC CAP.	DD104-979SL390J50	39pF	50V SL
C 9901	K46170021	AL. ELECTRO. CAP.	50V100M5X11TR5	10uF	50V
C 9902	K46170021	AL. ELECTRO. CAP.	50V100M5X11TR5	10uF	50V
C 9903	K26170726	CERAMIC CAP.	DD306-979F473Z50	0.047uF	50V F
C 9904	K00179021	CERAMIC CAP.	DD107SL301J50	300p	50V SL
C 9905	K26170657	CERAMIC CAP.	DD106-979F103Z50	0.01uF	50V F
C 9907	K26170657	CERAMIC CAP.	DD106-979F103Z50	0.01uF	50V F
C 9908	K46170021	AL. ELECTRO. CAP.	50V100M5X11TR5	10uF	50V
C 9909	K26170726	CERAMIC CAP.	DD306-979F473Z50	0.047uF	50V F
C 9910	K46170021	AL. ELECTRO. CAP.	50V100M5X11TR5	10uF	50V
C 9911	K26170726	CERAMIC CAP.	DD306-979F473Z50	0.047uF	50V F
D 9801	G2050007	DIODE	1SS83RE		
D 9802	G2050007	DIODE	1SS83RE		
D 9803	G2050007	DIODE	1SS83RE		
D 9804	G2050007	DIODE	1SS83RE		
D 9805	G2050007	DIODE	1SS83RE		
D 9806	G2050007	DIODE	1SS83RE		
D 9807	G2050007	DIODE	1SS83RE		
D 9808	G2050007	DIODE	1SS83RE		
D 9809	G2050007	DIODE	1SS83RE		
D 9810	G2050007	DIODE	1SS83RE		
D 9811	G2050007	DIODE	1SS83RE		
D 9812	G2050007	DIODE	1SS83RE		
D 9813	G2050007	DIODE	1SS83RE		
D 9814	G2050007	DIODE	1SS83RE		
D 9815	G2050007	DIODE	1SS83RE		
D 9816	G2050007	DIODE	1SS83RE		
D 9817	G2050007	DIODE	1SS83RE		
D 9818	G2050007	DIODE	1SS83RE		
D 9819	G2050007	DIODE	1SS83RE		
D 9820	G2050007	DIODE	1SS83RE		
D 9821	G2050007	DIODE	1SS83RE		
D 9822	G2050007	DIODE	1SS83RE		
D 9823	G2050007	DIODE	1SS83RE		
D 9824	G2050007	DIODE	1SS83RE		
D 9825	G2050007	DIODE	1SS83RE		
D 9826	G2050007	DIODE	1SS83RE		
D 9827	G2050007	DIODE	1SS83RE		
D 9828	G2050007	DIODE	1SS83RE		
D 9829	G2060004	DIODE	1SS270TJ		
D 9830	G2060004	DIODE	1SS270TJ		
D 9831	G2050007	DIODE	1SS83RE		
D 9832	G2050007	DIODE	1SS83RE		
D 9833	G2050007	DIODE	1SS83RE		
D 9834	G2050007	DIODE	1SS83RE		
D 9835	G2050007	DIODE	1SS83RE		
D 9836	G2050007	DIODE	1SS83RE		
D 9837	G2090188	DIODE	HZ5C1		
D 9838	G2060004	DIODE	1SS270TJ		
D 9839	G2060004	DIODE	1SS270TJ		
D 9840	G2060004	DIODE	1SS270TJ		
D 9841	G2060004	DIODE	1SS270TJ		
D 9842	G2060004	DIODE	1SS270TJ		
D 9843	G2060004	DIODE	1SS270TJ		
D 9844	G2050007	DIODE	1SS83RE		
D 9845	G2050007	DIODE	1SS83RE		
D 9846	Q9000375	SURGE ABSORBER	DSP201M-S00B		
J 9802	P0090712	CONNECTOR	SC25-02WL		
J 9803	P0090638	CONNECTOR	SC25-05WL		
J 9804	P0090713	CONNECTOR	SC25-04WL		
L 9801	L0021222	COIL	0.240U T25-6		
L 9802	L0020927	COIL	0.280U T25-6		
L 9803	L1790069	M.RFC	LAP02TA820K	82uH	
L 9804	L1790070	M.RFC	LAP02TA101K	100uH	
L 9805	L1790069	M.RFC	LAP02TA820K	82uH	
L 9806	L1790164	M.RFC	LAL03VB102K	1mH	
L 9807	L1790164	M.RFC	LAL03VB102K	1mH	
L 9808	L1790068	M.RFC	LAP02TA680K	68uH	

For Service Manuals Contact
MAURITRON TECHNICAL SERVICES
 8 Cherry Tree Rd, Chinnor
 Oxon OX9 4QY
 Tel: 01844-351634 Fax: 01844-352554
 Email: enquiries@mauritron.co.uk

BPF-1 Parts List

ADD	CODE NO	DESCRIPTION	DEVICE	TYP VAL
L 9809	L1790063	M. RFC	LAP02TA270K	27uH
L 9810	L1790065	M. RFC	LAP02TA390K	39uH
L 9811	L1790063	M. RFC	LAP02TA270K	27uH
L 9812	L1790068	M. RFC	LAP02TA680K	68uH
L 9813	L1790064	M. RFC	LAP02TA330K	33uH
L 9814	L1790060	M. RFC	LAP02TA150K	15uH
L 9816	L1790064	M. RFC	LAP02TA330K	33uH
L 9817	L1790058	M. RFC	LAP02TA100K	10uH
L 9818	L1790063	M. RFC	LAP02TA270K	27uH
L 9819	L1790055	M. RFC	LAP02TA5R6K	5.6uH
L 9820	L1790063	M. RFC	LAP02TA270K	27uH
L 9821	L1790058	M. RFC	LAP02TA100K	10uH
L 9822	L1790056	M. RFC	LAP02TA6R8K	6.8uH
L 9823	L1790062	M. RFC	LAP02TA220K	22uH
L 9824	L1790052	M. RFC	LAP02TA3R3K	3.3uH
L 9825	L1790062	M. RFC	LAP02TA220K	22uH
L 9826	L1790056	M. RFC	LAP02TA6R8K	6.8uH
L 9827	L1790055	M. RFC	LAP02TA5R6K	5.6uH
L 9828	L1790059	M. RFC	LAP02TA120K	12uH
L 9829	L1790051	M. RFC	LAP02TA2R7K	2.7u
L 9830	L1790059	M. RFC	LAP02TA120K	12uH
L 9831	L1790055	M. RFC	LAP02TA5R6K	5.6uH
L 9832	L1790049	M. RFC	LAP02TA1R8K	1.8u
L 9833	L1790060	M. RFC	LAP02TA150K	15uH
L 9834	L1790047	M. RFC	LAP02TA1R2K	1.2u
L 9835	L1790060	M. RFC	LAP02TA150K	15uH
L 9836	L1790049	M. RFC	LAP02TA1R8K	1.8u
L 9837	L1790049	M. RFC	LAP02TA1R8K	1.8u
L 9838	L1790058	M. RFC	LAP02TA100K	10uH
L 9839	L1790046	M. RFC	LAP02TA1R0K	1uH
L 9840	L1790058	M. RFC	LAP02TA100K	10uH
L 9841	L1790049	M. RFC	LAP02TA1R8K	1.8u
L 9842	L1790047	M. RFC	LAP02TA1R2K	1.2u
L 9843	L1790058	M. RFC	LAP02TA100K	10uH
L 9844	L1790044	M. RFC	LAP02TA68K	0.68uH
L 9845	L1790058	M. RFC	LAP02TA100K	10uH
L 9846	L1790047	M. RFC	LAP02TA1R2K	1.2u
L 9847	L1790046	M. RFC	LAP02TA1R0K	1uH
L 9848	L1790057	M. RFC	LAP02TA8R2K	8.2uH
L 9849	L1790043	M. RFC	LAP02TA8R2K	8.2uH
L 9850	L1790057	M. RFC	LAP02TA8R2K	8.2uH
L 9851	L1790046	M. RFC	LAP02TA1R0K	1uH
L 9852	L1790046	M. RFC	LAP02TA1R0K	1uH
L 9853	L1790053	M. RFC	LAP02TA3R9K	3.9uH
L 9854	L1790043	M. RFC	LAP02TA8R2K	8.2uH
L 9855	L1790053	M. RFC	LAP02TA3R9K	3.9uH
L 9856	L1790046	M. RFC	LAP02TA1R0K	1uH
L 9857	L1790044	M. RFC	LAP02TA8R8K	0.68uH
L 9858	L1790052	M. RFC	LAP02TA3R3K	3.3uH
L 9859	L1790041	M. RFC	LAP02TA3R9K	0.39uH
L 9860	L1790052	M. RFC	LAP02TA3R3K	3.3uH
L 9861	L1790044	M. RFC	LAP02TA8R8K	0.68uH
L 9862	L1790152	M. RFC	LAL03VB101K	100uH
Q 9801	G1090979	IC	UPD74HC238C	
Q 9802	G1090836	IC	M54564P	
Q 9803	G1090979	IC	UPD74HC238C	
Q 9804	G1090836	IC	M54564P	
Q 9805	G3050002	TRANSISTOR	BN1A4P-T	
Q 9806	G3050002	TRANSISTOR	BN1A4P-T	
R 9801	J07225470	CARBON FILM RES.	RD16TPJ470 47	47 1/6W
R 9802	J07225151	CARBON FILM RES.	RD16TPJ151 150	150 1/6W
R 9803	J07225101	CARBON FILM RES.	RD16TPJ101 100	100 1/6W
R 9804	J07225680	CARBON FILM RES.	RD16TPJ680 68	68 1/6W
R 9805	J07225330	CARBON FILM RES.	RD16TPJ330 33	33 1/6W
R 9806	J07225391	CARBON FILM RES.	RD16TPJ391 390	390 1/6W
R 9807	J07225271	CARBON FILM RES.	RD16TPJ271 270	270 1/6W
R 9808	J07225391	CARBON FILM RES.	RD16TPJ391 390	390 1/6W
R 9809	J07225101	CARBON FILM RES.	RD16TPJ101 100	100 1/6W
R 9810	J07225330	CARBON FILM RES.	RD16TPJ330 33	33 1/6W
R 9811	J07225331	CARBON FILM RES.	RD16TPJ331 330	330 1/6W
R 9812	J07225101	CARBON FILM RES.	RD16TPJ101 100	100 1/6W
R 9813	J07225330	CARBON FILM RES.	RD16TPJ330 33	33 1/6W
R 9814	J07225101	CARBON FILM RES.	RD16TPJ101 100	100 1/6W
R 9815	J07225330	CARBON FILM RES.	RD16TPJ330 33	33 1/6W
R 9816	J07225101	CARBON FILM RES.	RD16TPJ101 100	100 1/6W
R 9817	J07225330	CARBON FILM RES.	RD16TPJ330 33	33 1/6W
R 9818	J07225101	CARBON FILM RES.	RD16TPJ101 100	100 1/6W
R 9819	J07225330	CARBON FILM RES.	RD16TPJ330 33	33 1/6W
R 9820	J07225101	CARBON FILM RES.	RD16TPJ101 100	100 1/6W
R 9821	J07225330	CARBON FILM RES.	RD16TPJ330 33	33 1/6W
R 9822	J07225101	CARBON FILM RES.	RD16TPJ101 100	100 1/6W
R 9823	J07225330	CARBON FILM RES.	RD16TPJ330 33	33 1/6W
R 9824	J07225101	CARBON FILM RES.	RD16TPJ101 100	100 1/6W

BPF-1 Parts List

ADD	CODE NO	DESCRIPTION	DEVICE	TYP	VAL
R 9825	J07225330	CARBON FILM RES.	RD16TPJ330 33	33	1/6W
R 9826	J07225101	CARBON FILM RES.	RD16TPJ101 100	100	1/6W
R 9827	J07225330	CARBON FILM RES.	RD16TPJ330 33	33	1/6W
R 9828	J07225101	CARBON FILM RES.	RD16TPJ101 100	100	1/6W
R 9829	J07225330	CARBON FILM RES.	RD16TPJ330 33	33	1/6W
R 9830	J07225221	CARBON FILM RES.	RD16TPJ221 220	220	1/6W
R 9831	J07225681	CARBON FILM RES.	RD16TPJ681 680	680	1/6W
R 9832	J07225330	CARBON FILM RES.	RD16TPJ330 33	33	1/6W
R 9833	J07225473	CARBON FILM RES.	RD16TPJ473 47K	47K	1/6W
R 9834	J07225473	CARBON FILM RES.	RD16TPJ473 47K	47K	1/6W
R 9835	J07225473	CARBON FILM RES.	RD16TPJ473 47K	47K	1/6W
RL9801	M1190090	RELAY	AG4013 DC12V		DC12V
RL9802	M1190090	RELAY	AG4013 DC12V		DC12V
S 9801	N0190151	ROTARY SWITCH SRBM15 L=15	SRBM15 L=15MM		
T 9801	L0020883	COIL	4-1 2001F		
T 9802	L0020883	COIL	4-1 2001F		

For Service Manuals Contact
MAURITRON TECHNICAL SERVICES
 8 Cherry Tree Rd, Chinnor
 Oxon OX9 4QY
 Tel: 01844-351884 Fax: 01844-352554
 Email: enquiries@maurtron.co.uk

For Service Manuals Contact
MAURITRON TECHNICAL SERVICES
8 Cherry Hill, Chinnor
Oxon OX9 4QY
Tel: 01844-351604 Fax: 01844-352554
Email: enquiries@mauriron.co.uk

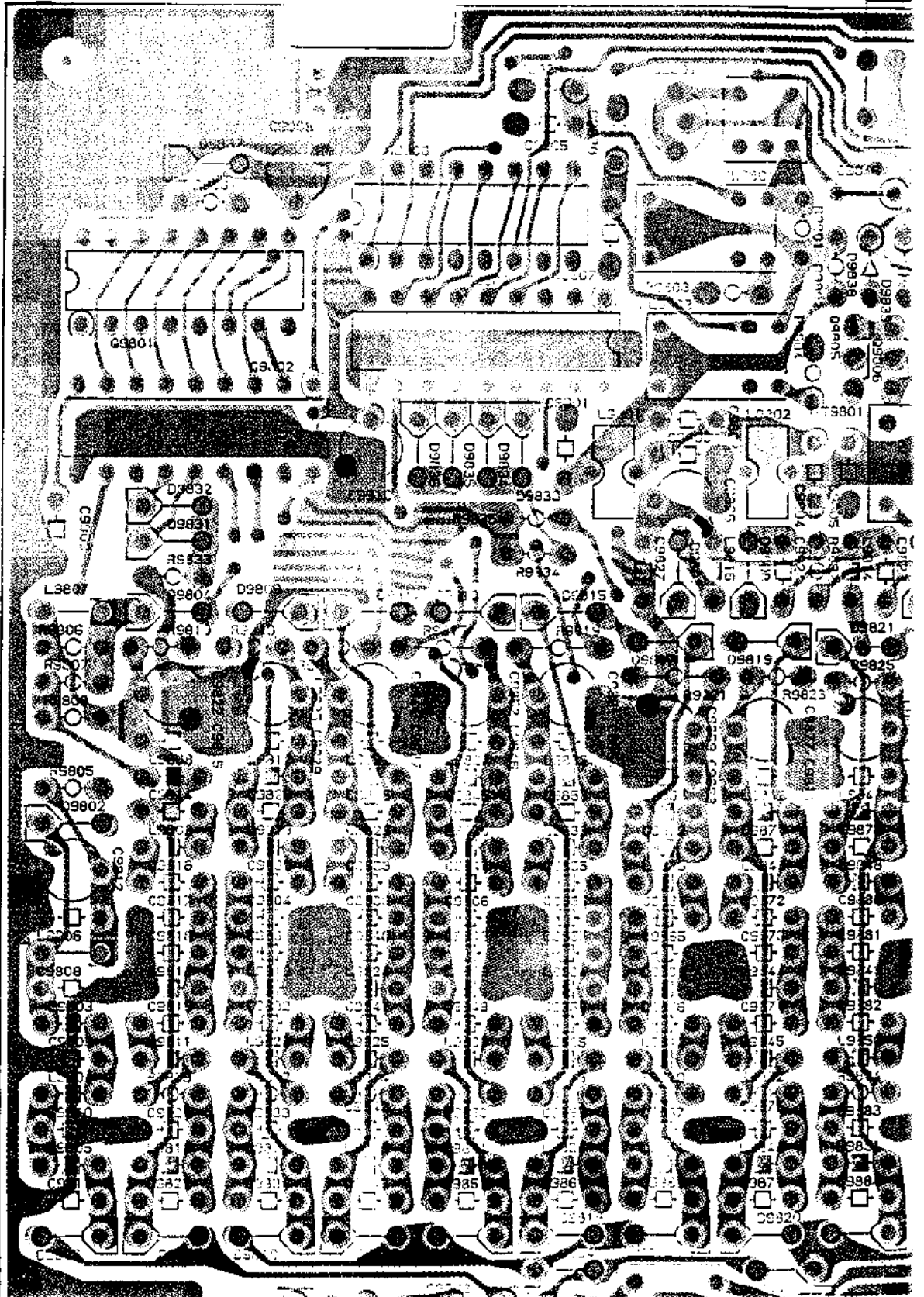

For Service Manuals Contact
MAURITRON TECHNICAL SERVICES
8 Cherry Tree Rd, Chinnor
Oxon OX9 4QY
Tel: 01844-351694 Fax: 01844-352554
Email: enquiries@mauritron.co.uk

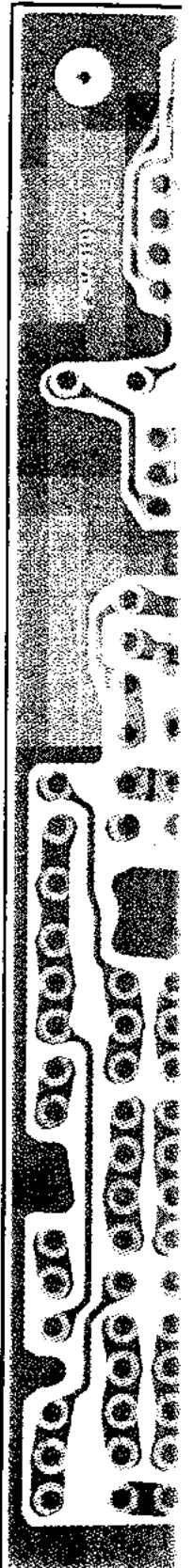
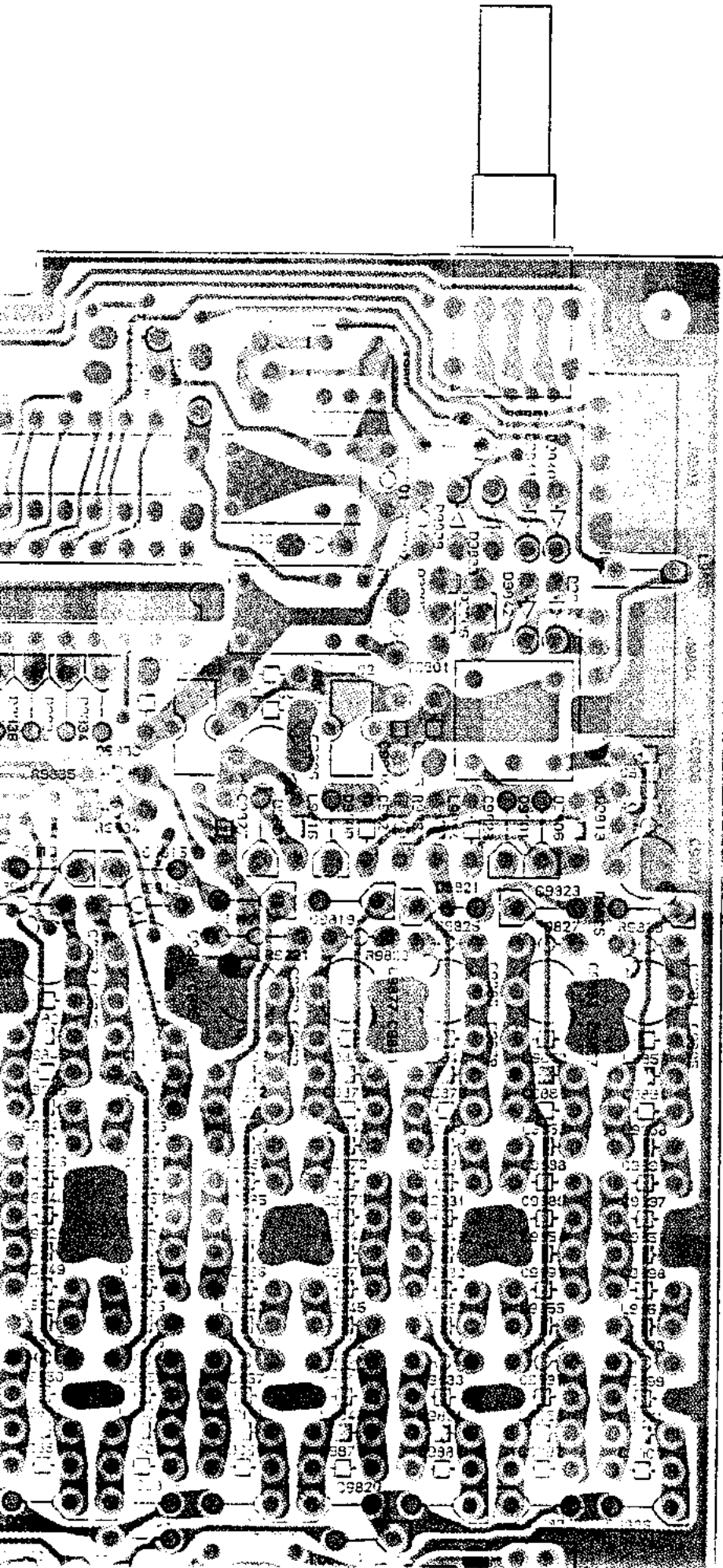

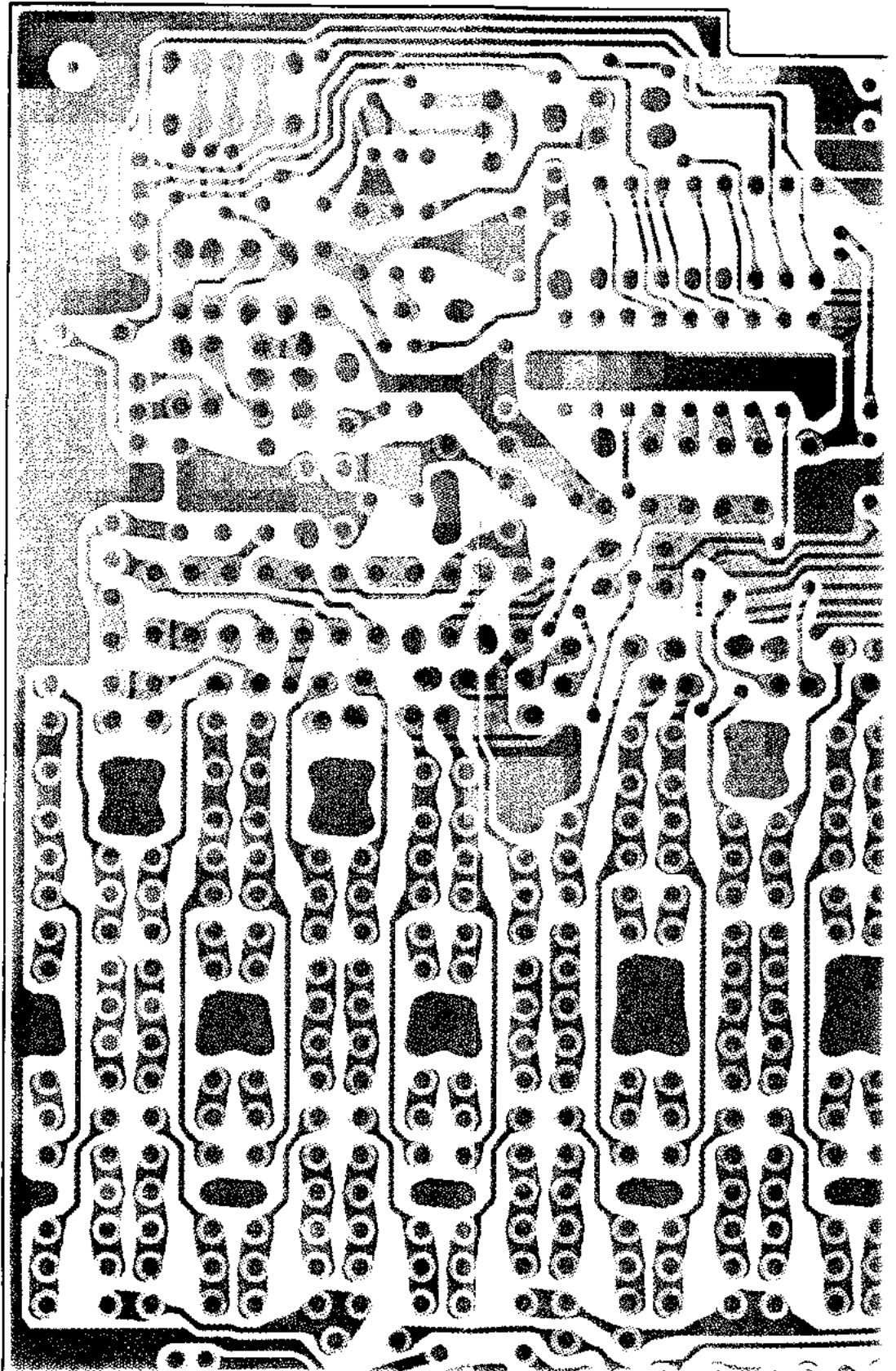

BPF-1 Board Layout

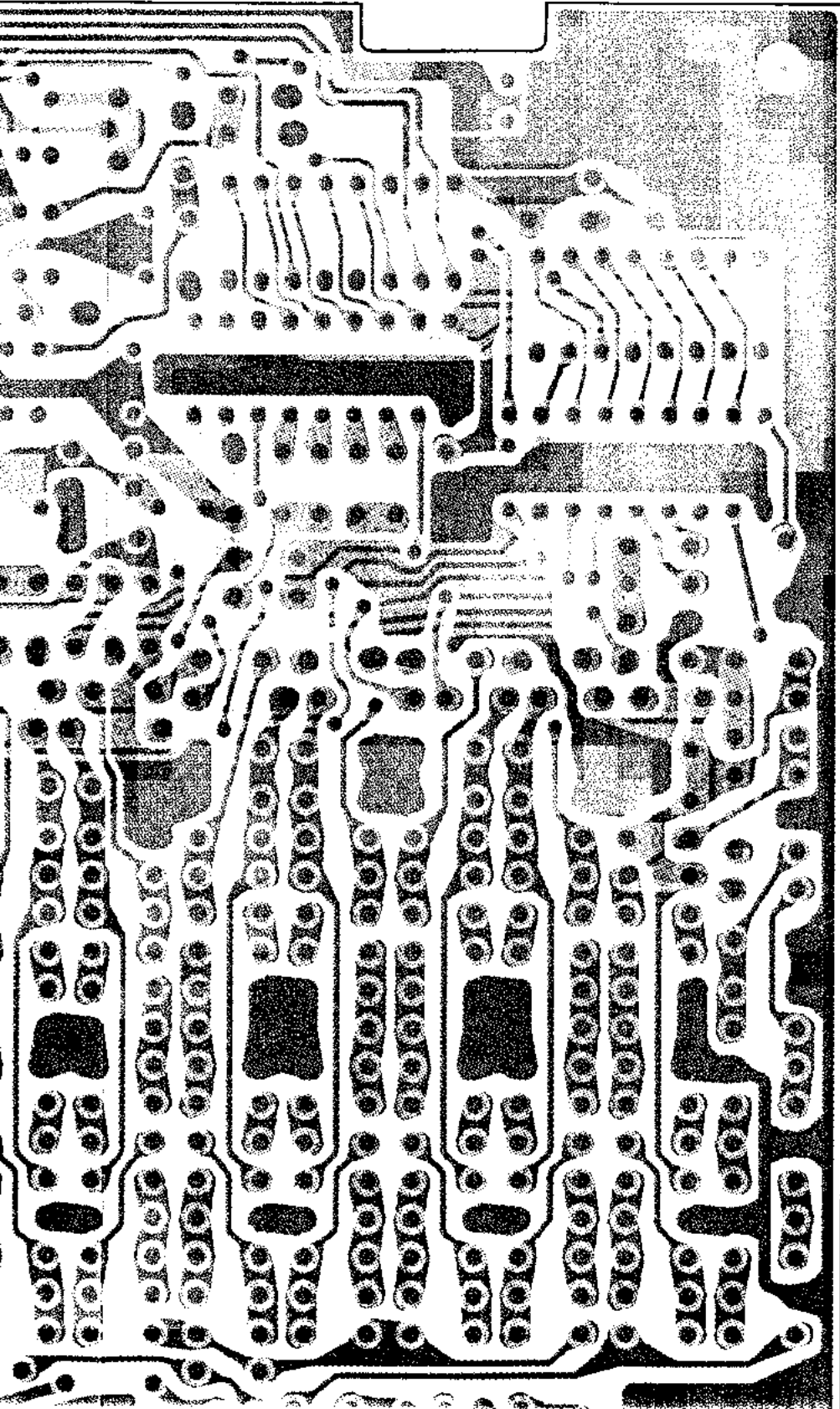

For Service Manuals Contact
MAURITRON TECHNICAL SERVICES
8 Cherry Tree Rd, Chinnor
Oxon OX9 4QY
Tel:- 01844-351694 Fax:- 01844-352654
Email:- enquiries@mauritron.co.uk

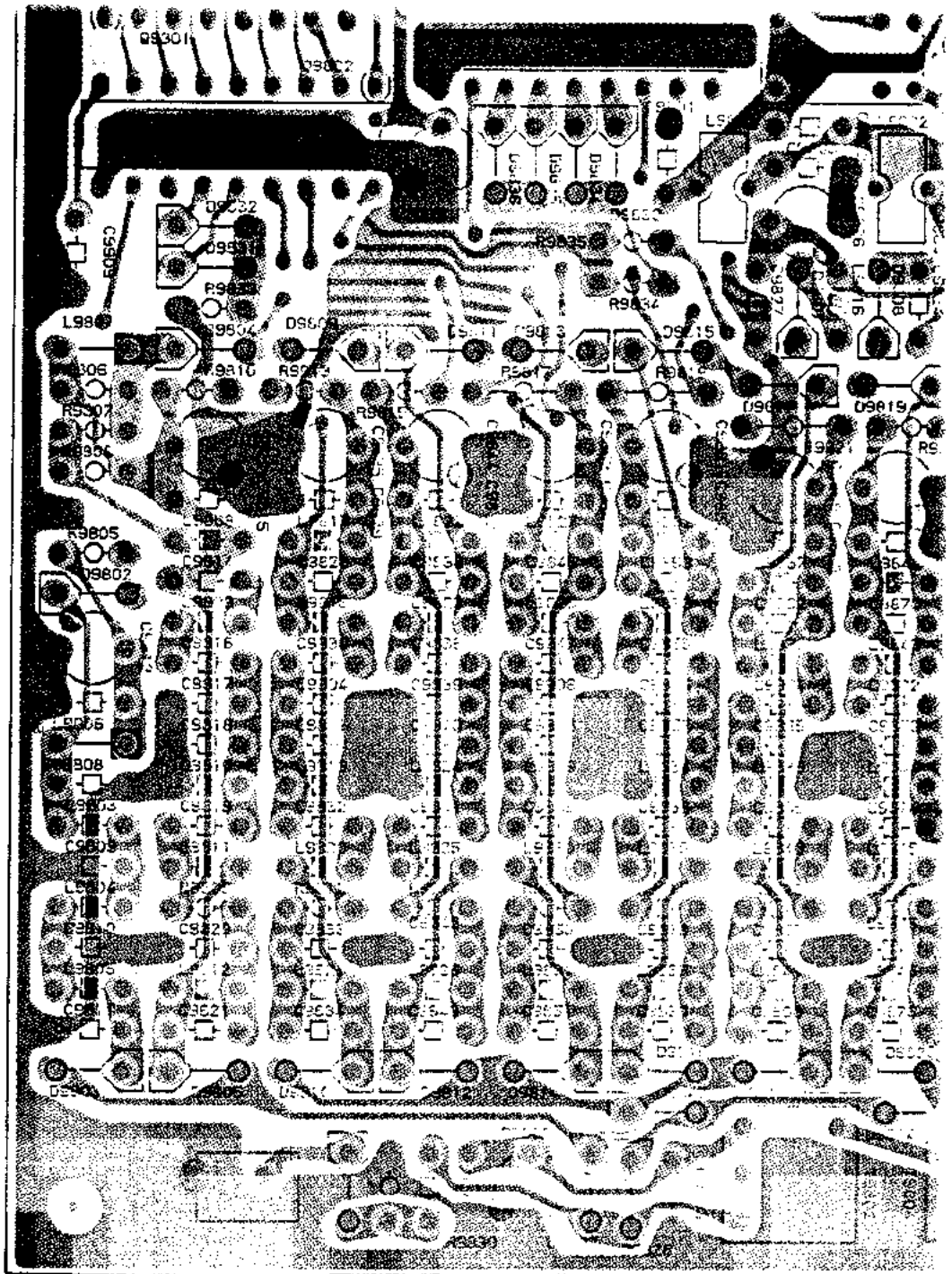

(obverse

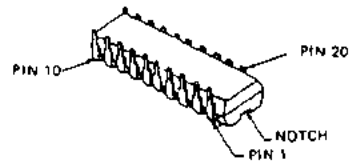

M54564P
(Q9802, Q9804)

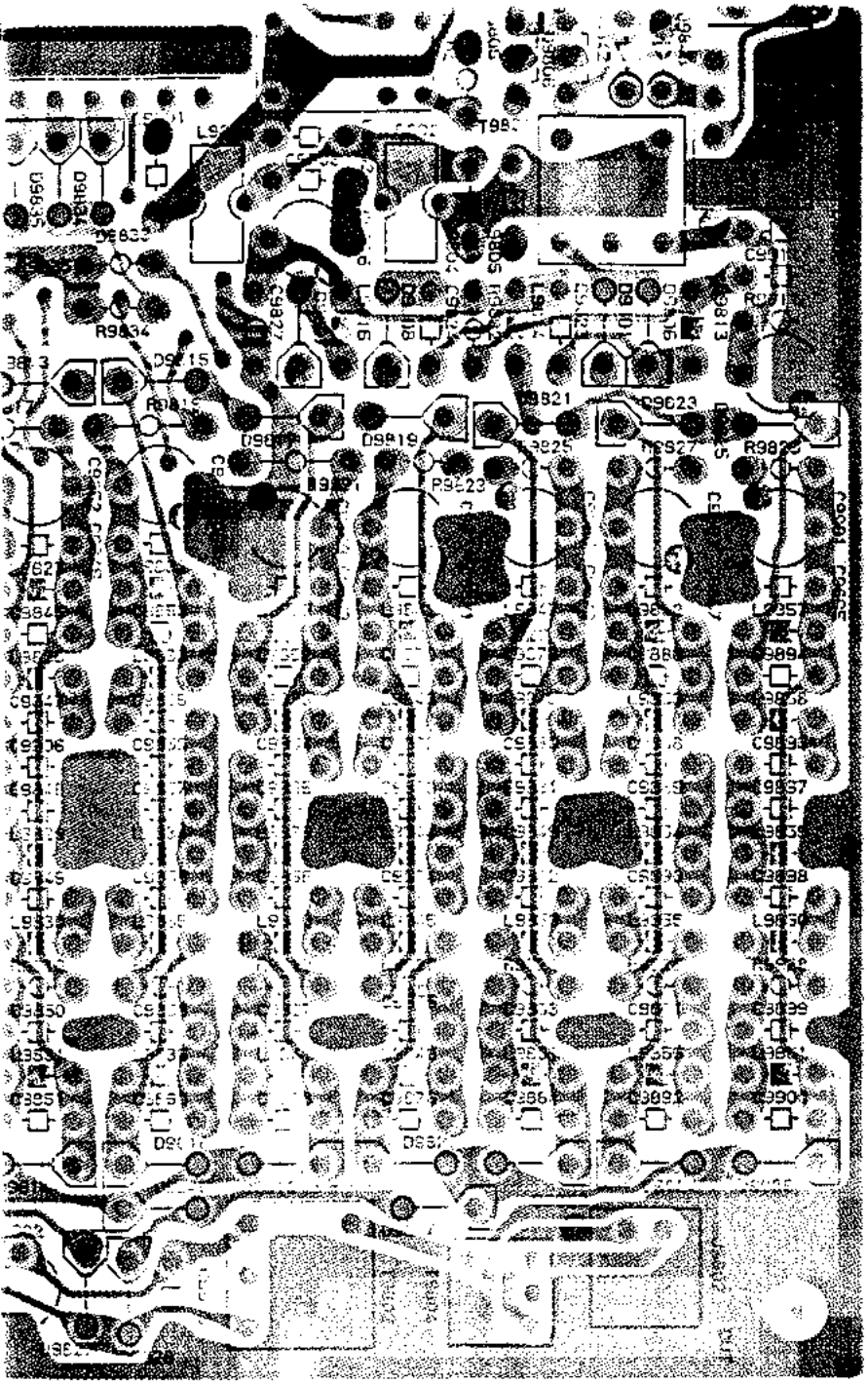

(obverse view of "component" side)

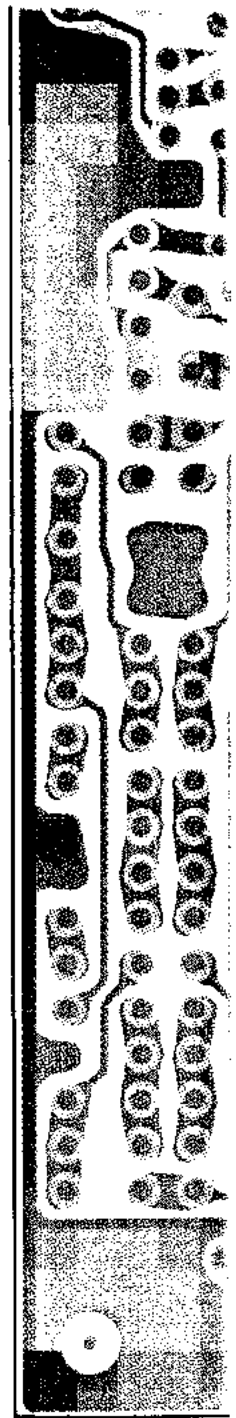

For Service Manuals Contact
MAURITRON TECHNICAL SERVICES
 8 Cherry Tree Rd, Chinnor
 Oxon OX9 4QY
 Tel: 01844-351004 Fax: 01844-352554
 Email: enquiries@mauritron.co.uk

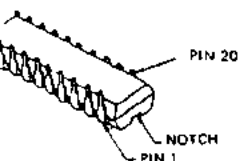

154564P
 (Q9802, Q9804)

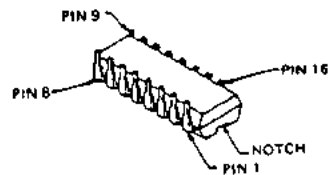

μ PD74HC238C
 (Q9801, Q9803)

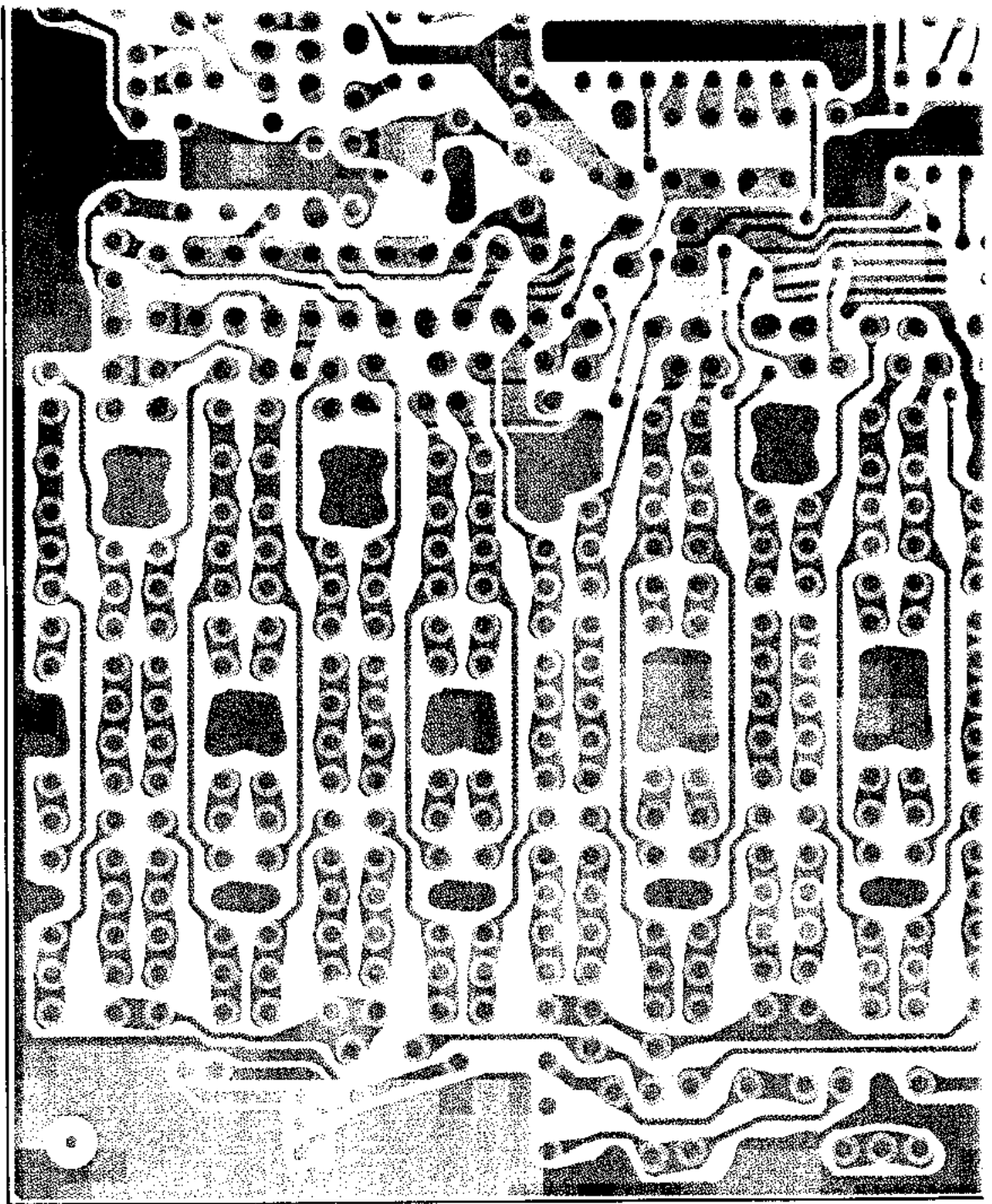

(obverse view)

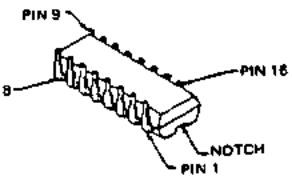

μ PD74HC238C
(Q9801, Q9803)

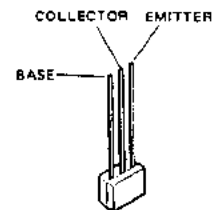

BN1A4P
(Q9805, Q9806)

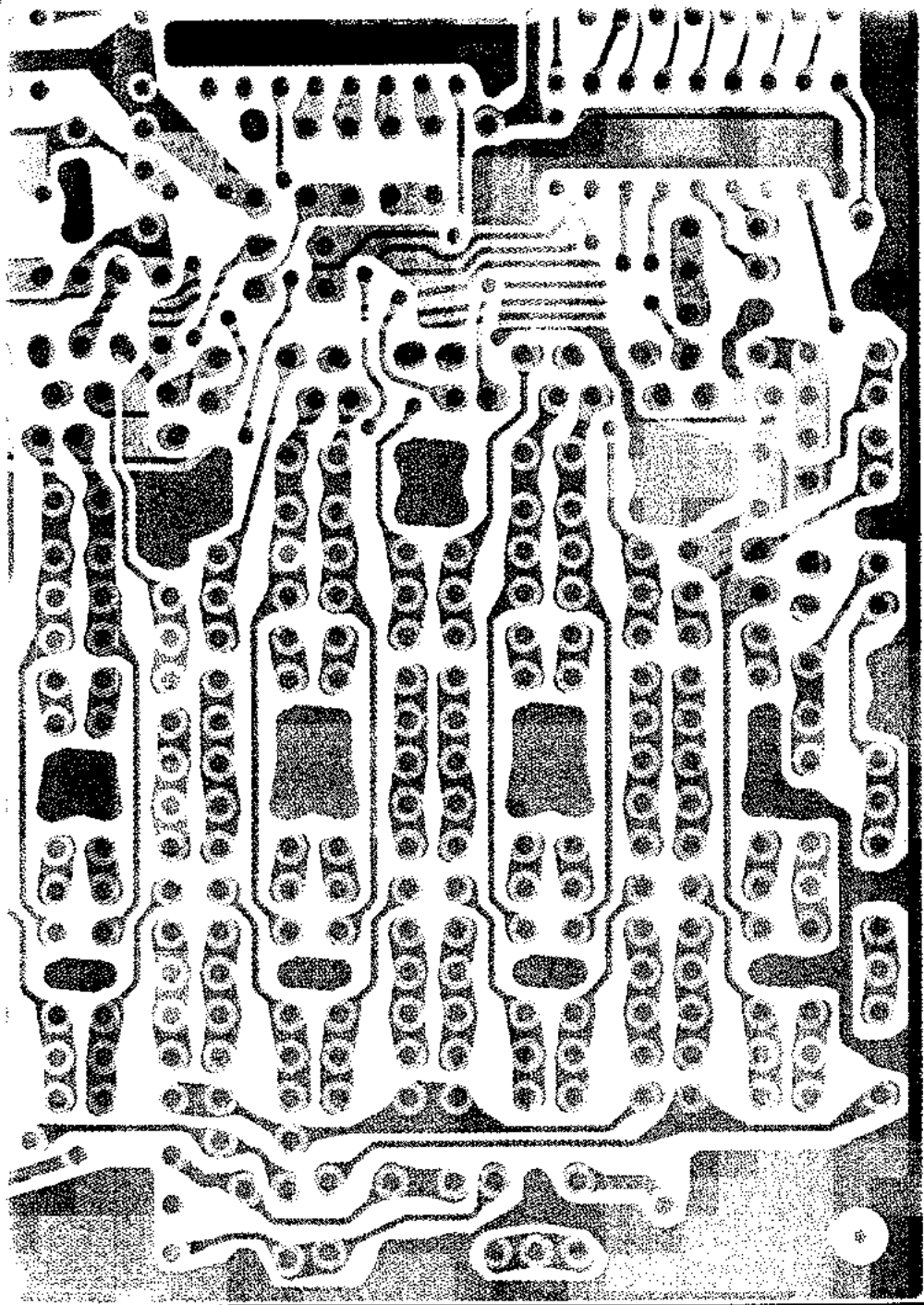

(obverse view of "solder" side)

For Service Manuals Contact
MAURITRON TECHNICAL SERVICES
 8 Cherry Tree Rd, Chinnor
 Oxon OX9 4QY
 Tel: 01844-351694 Fax: 01844-352554
 Email: enquiries@mauritron.co.uk

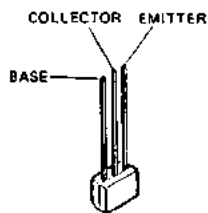

BN1A4P
 (Q9805, Q9806)

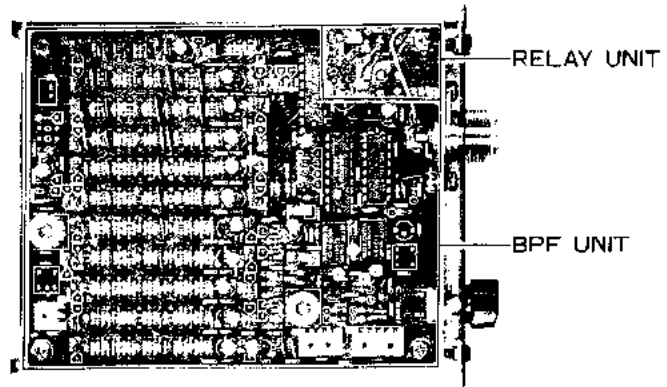

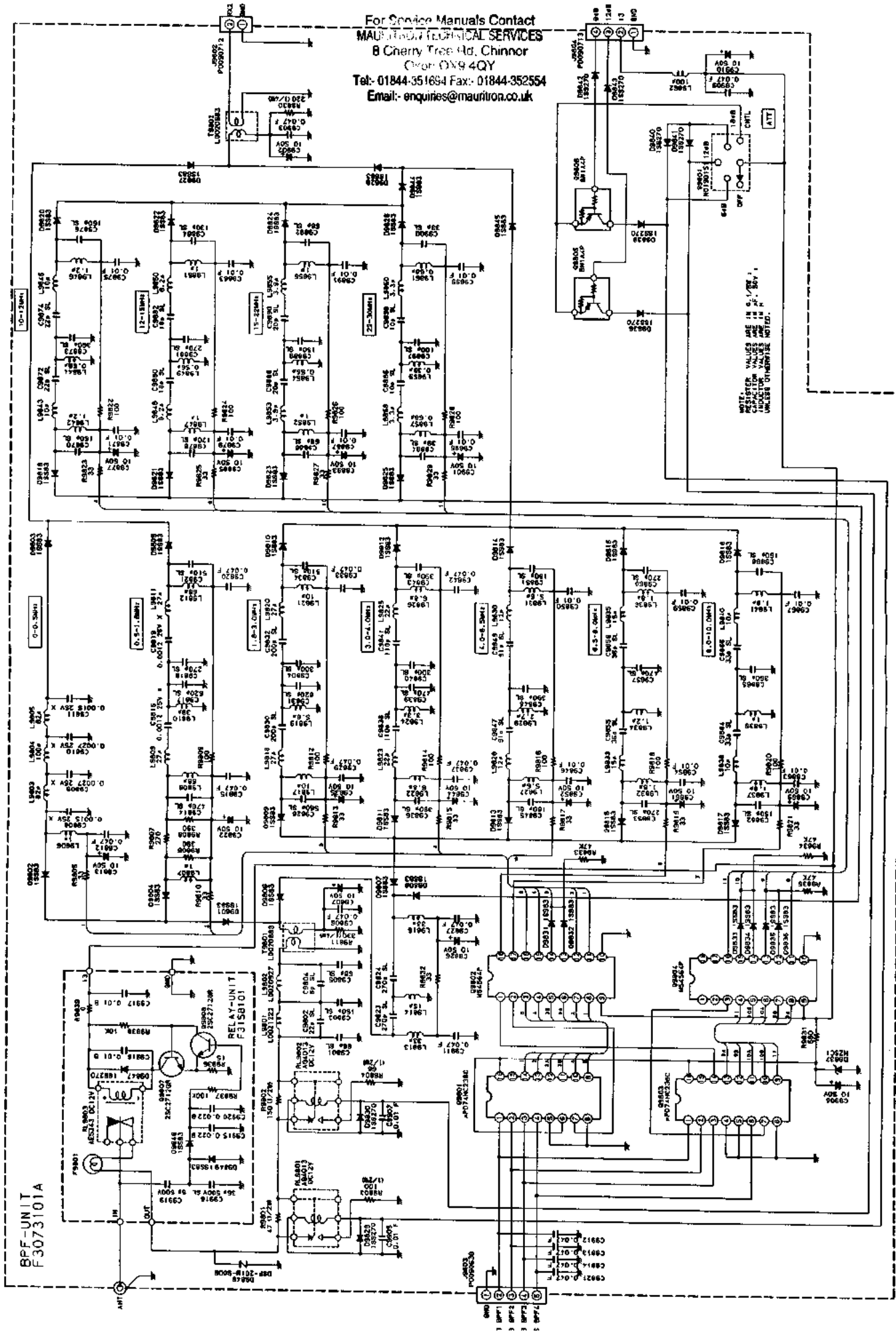

BPF-1 Relay Unit Layout & Schematic

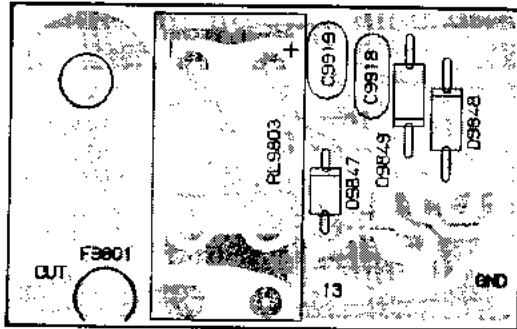

(obverse view of "component" side)

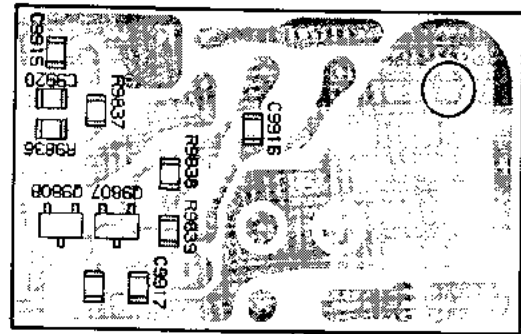

(obverse view of "chip-only" side)

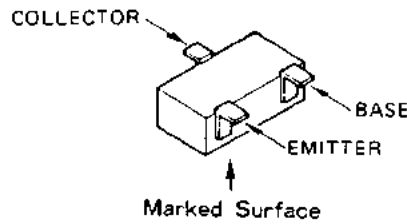

2SC271 2GR
(Q9807, Q9808)

For Service Manuals Contact
MAURITRON TECHNICAL SERVICES
8 Cherry Tree Rd, Chinnor
Oxon OX9 4QY
Tel: 01844-351694 Fax: 01844-352554
Email: enquires@mauritron.co.uk

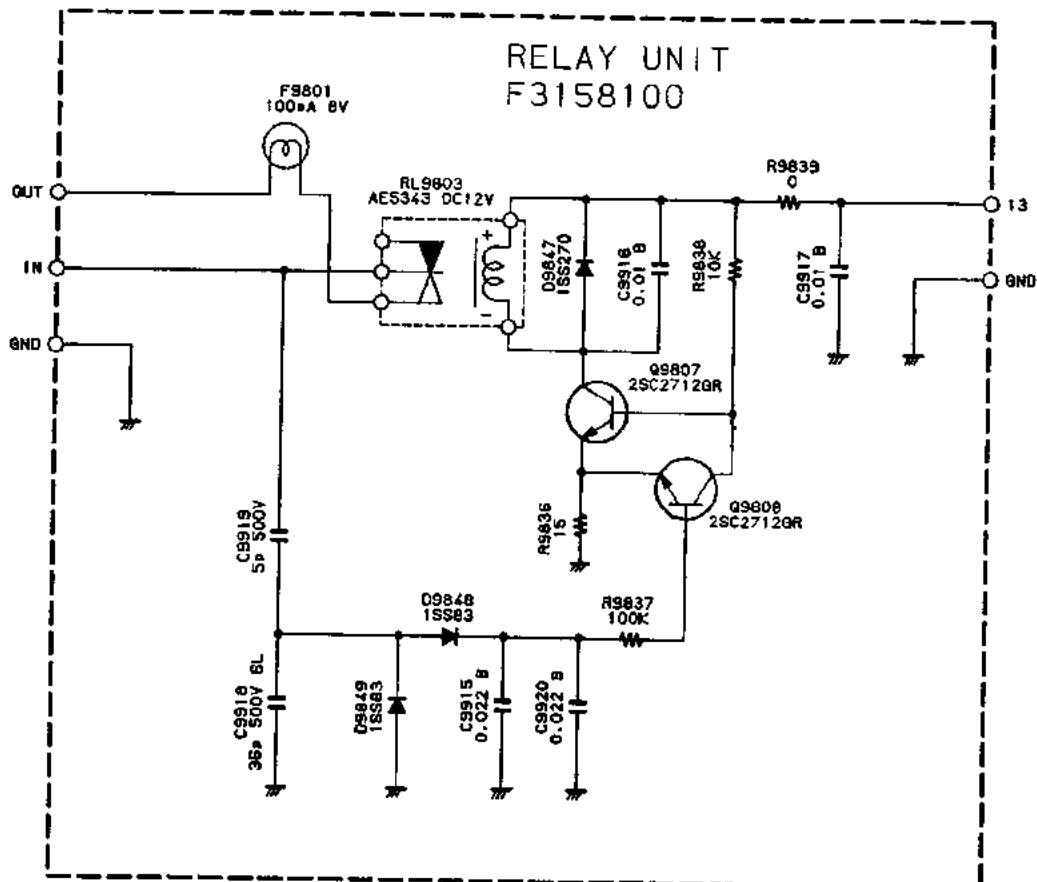

Notes

TCXO-1 Packaging

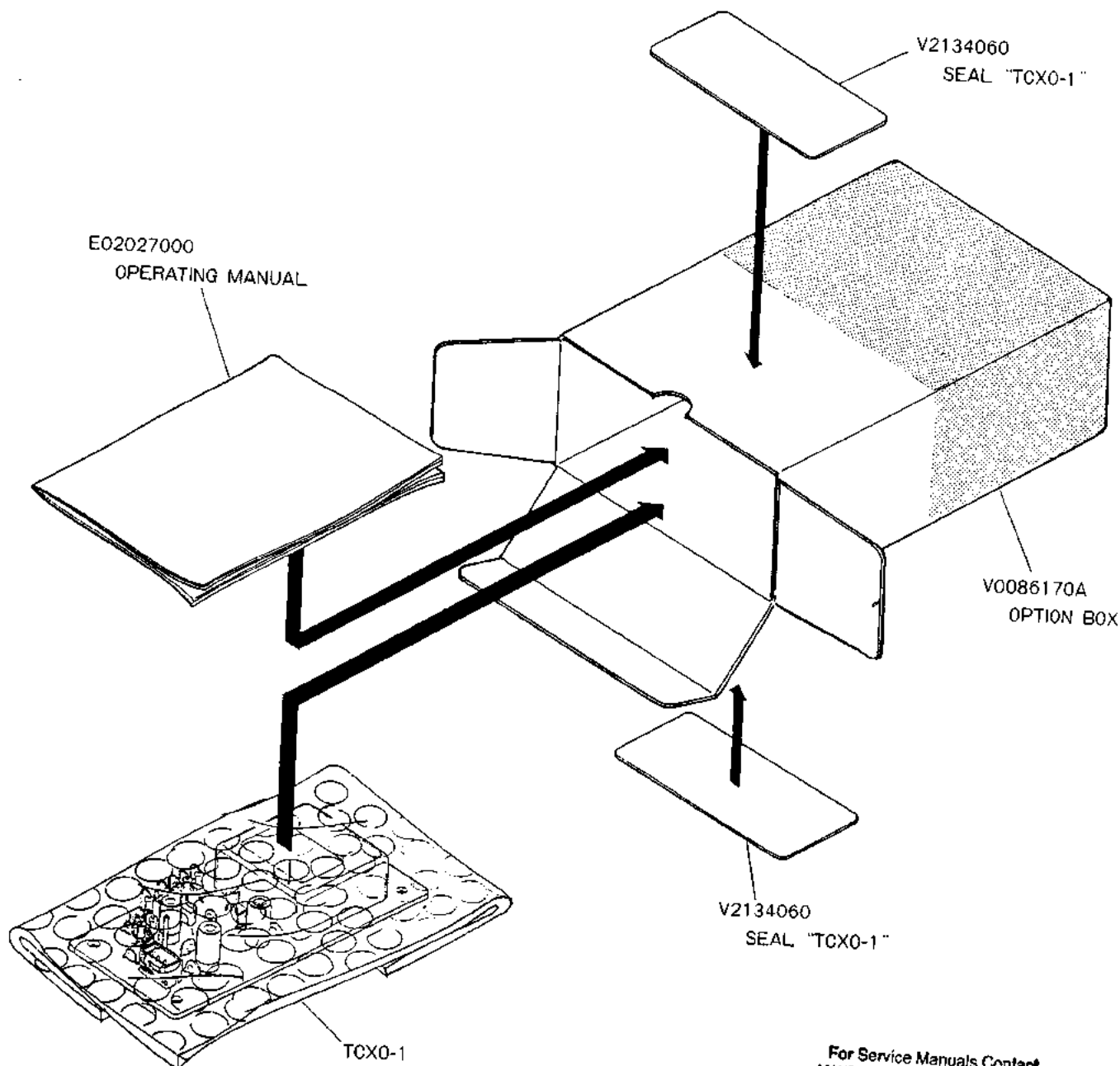

For Service Manuals Contact
MAURITRON TECHNICAL SERVICES
8 Cherry Tree Rd, Chinnor
Oxon OX9 4QY
Tel:- 01844-351694 Fax:- 01844-352554
Email:- enquiries@mauritron.co.uk

TCXO-1 Parts List

ADD	CODE NO	DESCRIPTION	DEVICE	TYP VAL		
** UNIT NAME : REF-UNIT						
C	7901	K26170657 CERAMIC CAP.	DD106-979F103Z50	0.01uF	50V	F
C	7902	K46140005 AL.ELECTRO.CAP.	25V101M6X11TR5	100uF	25V	
C	7903	K26171005 CERAMIC CAP.	DD104-979SL100D50	10pF	50V	SL
C	7904	K26171021 CERAMIC CAP.	DD104-979SL470J50	47pF	50V	SL
C	7905	K46140005 AL.ELECTRO.CAP.	25V101M6X11TR5	100uF	25V	
C	7906	K26170657 CERAMIC CAP.	DD106-979F103Z50	0.01uF	50V	F
C	7907	K26170657 CERAMIC CAP.	DD106-979F103Z50	0.01uF	50V	F
C	7908	K46140005 AL.ELECTRO.CAP.	25V101M6X11TR5	100uF	25V	
C	7909	K26170657 CERAMIC CAP.	DD106-979F103Z50	0.01uF	50V	F
C	7910	K26171608 CERAMIC CAP.	DD104-979B331K50	330pF	50V	B
C	7911	K26171611 CERAMIC CAP.	DD104-979B561K50	560pF	50V	B
C	7912	K26171608 CERAMIC CAP.	DD104-979B331K50	330pF	50V	B
C	7913	K26170657 CERAMIC CAP.	DD106-979F103Z50	0.01uF	50V	F
J	7901	P0090622 CONNECTOR	SC25-03WS			
L	7901	L1790128 N.RFC	LAL03VB1R0M	1uH		
L	7902	L1790128 M.RFC	LAL03VB1R0M	1uH		
Q	7901	G3801921G FET	2SK192AGR			
Q	7902	G3305354B TRANSISTOR	2SC535BTZ			
R	7901	J06245470 CARBON FILM RES.	RD25UJ470T 47	47	1/4W	
R	7902	J06245223 CARBON FILM RES.	RD25UJ223T 22K	22K	1/4W	
R	7903	J06245223 CARBON FILM RES.	RD25UJ223T 22K	22K	1/4W	
R	7904	J06245681 CRABON FILM RES.RD25UJ681T 680	RD25UJ681T 680	680	1/4W	
R	7905	J06245470 CARBON FILM RES.	RD25UJ470T 47	47	1/4W	
R	7906	J06245223 CARBON FILM RES.	RD25UJ223T 22K	22K	1/4W	
R	7907	J06245223 CARBON FILM RES.	RD25UJ223T 22K	22K	1/4W	
R	7908	J06245471 CARBON FILM RES.	RD25UJ471T 470	470	1/4W	
R	7909	J06245470 CARBON FILM RES.	RD25UJ470T 47	47	1/4W	
TP	7901	Q5000026 TP-F	TP-F IPS-1032			
X	7901	H9500150 XTAL	CF-1032 10.18576			

TCO 1032

For Service Manuals Contact
 MAURITRON TECHNICAL SERVICES
 8 Cherry Tree Rd, Chinnor
 Oxon OX9 4QY
 Tel: 01844-351694 Fax: 01844-352554
 Email: enquiries@mauritron.co.uk

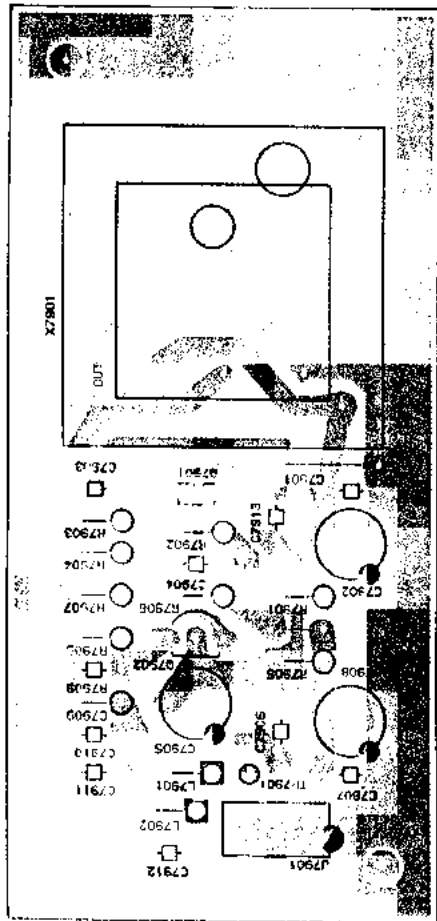

(obverse view of "component" side)

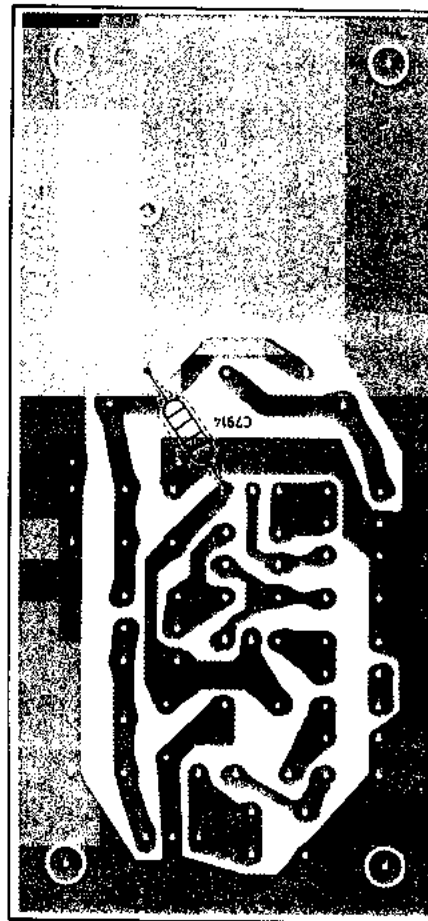

(obverse view of "chip-only" side)

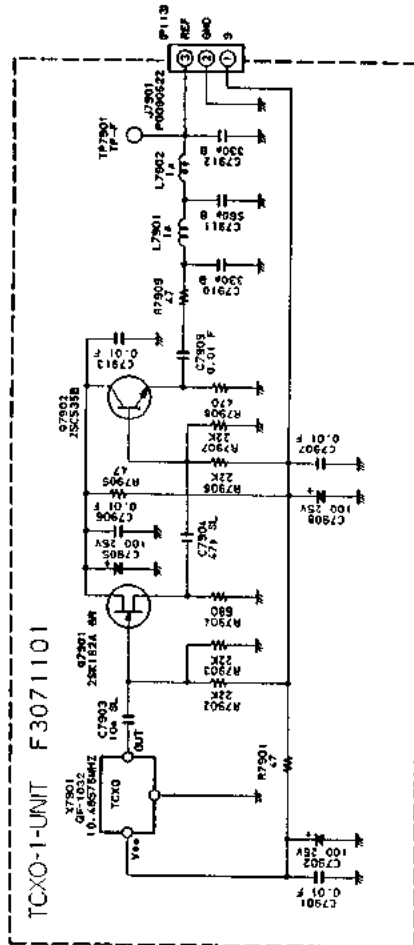

(schematic diagram)

NOTE: RESISTOR VALUES ARE IN OHMS UNLESS NOTED.
 CAPACITOR VALUES ARE IN pF UNLESS NOTED.
 INDUCTOR VALUES ARE IN nH UNLESS OTHERWISE NOTED.

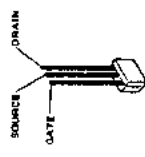

2SK1924BR (07901)

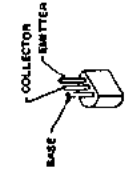

2SC535BTZ (07902)

For Service Manuals Contact
 MAURITRON TECHNICAL SERVICES
 8 Cherry Tree Rd, Chinnor
 Oxon OX9 4QY
 Tel: 01844-351894 Fax: 01844-352554
 Email: enquiries@mauritron.co.uk